

R&S®MXO 5 Series Oscilloscope User Manual



1802336902
Version 02

ROHDE & SCHWARZ
Make ideas real



This manual describes the following R&S®MXO 5 models with firmware version 2.0.x.x.

- R&S®MXO54, 4 channels (1802.1008k04)
- R&S®MXO58, 8 channels (1802.1008k08)

© 2023 Rohde & Schwarz

Muehldorfstr. 15, 81671 Muenchen, Germany

Phone: +49 89 41 29 - 0

Email: info@rohde-schwarz.com

Internet: www.rohde-schwarz.com

Subject to change – data without tolerance limits is not binding.

R&S® is a registered trademark of Rohde & Schwarz GmbH & Co. KG.

The terms HDMI, HDMI High-Definition Multimedia Interface, HDMI trade dress and the HDMI Logos are trademarks or registered trademarks of HDMI Licensing Administrator, Inc.

All other trademarks are the properties of their respective owners.

1802.3369.02 | Version 02 | R&S®MXO 5 Series

Throughout this manual, products from Rohde & Schwarz are indicated without the ® symbol, e.g. R&S®MXO 5 series oscilloscope is indicated as R&S MXO 5.

Contents

1	Safety and regulatory information.....	15
1.1	Safety instructions.....	15
1.2	Labels on the product.....	20
1.3	Warning messages in the documentation.....	20
1.4	Where to find key documents on Rohde & Schwarz.....	21
1.5	Korea certification class A.....	21
2	Preface.....	22
2.1	Key features.....	22
2.2	Options described in this document.....	22
3	Getting Started.....	24
3.1	Preparing for use.....	24
3.1.1	Lifting and carrying.....	24
3.1.2	Unpacking and checking.....	24
3.1.3	Choosing the operating site.....	24
3.1.4	Setting up the product.....	25
3.1.5	Considerations for test setup.....	27
3.1.6	Connecting to power.....	27
3.1.7	Connecting to LAN.....	28
3.1.8	Connecting external devices.....	28
3.1.9	Switching on or off.....	29
3.2	Instrument tour.....	30
3.2.1	Front view.....	30
3.2.2	Side view.....	32
3.2.3	Rear view.....	34
3.2.4	Keys and controls.....	35
3.2.5	Checking the functionality.....	42
4	Operating the instrument.....	45
4.1	Means of manual interaction.....	45
4.2	Touchscreen display.....	46
4.2.1	Information on the display.....	46

4.2.2	Control elements on the GUI.....	49
4.3	Applications.....	51
4.4	Working with waveforms.....	52
4.5	Rohde & Schwarz SmartGrid.....	54
4.6	Toolbar.....	56
4.6.1	Using the toolbar.....	56
4.6.2	Configuring the toolbar.....	56
4.6.3	Toolbar functions.....	57
4.7	Using dialog boxes.....	59
4.8	Entering data.....	60
4.9	Displaying results.....	62
4.10	Adding annotations.....	63
4.11	Information and notifications.....	65
4.12	Getting user assistance.....	67
4.12.1	Displaying help.....	67
4.12.2	Using help.....	67
5	Instrument setup.....	69
5.1	System settings.....	70
5.1.1	About settings.....	70
5.1.2	Network settings.....	70
5.1.3	Remote settings.....	73
5.1.4	Localization settings.....	74
5.1.5	Date and time settings.....	75
5.2	Option settings.....	76
5.2.1	Software options settings.....	76
5.3	Appearance settings.....	78
5.3.1	Colors.....	78
5.3.2	Grid.....	80
5.3.3	Dialogs.....	82
5.3.4	Peak list.....	83
5.3.5	Miscellaneous.....	84
5.4	Display settings.....	84
5.4.1	Persistence settings.....	84

5.4.2	Signal settings.....	85
5.4.3	Backlight settings.....	86
5.5	Front panel settings.....	87
5.5.1	Hardkeys: function assignment.....	87
5.5.2	Knobs.....	87
5.5.3	LED.....	88
5.6	Preset setup.....	88
5.6.1	Preset settings.....	89
5.6.2	Factory preset.....	90
5.6.3	Secure erase.....	90
5.6.4	Restoring settings.....	91
5.7	Maintenance settings.....	91
5.7.1	Firmware update.....	91
5.7.2	Alignment.....	92
5.7.3	Power management.....	94
5.7.4	Service.....	94
5.8	Save / recall.....	95
5.8.1	Autonaming.....	95
5.8.2	CSV export.....	98
6	Acquisition and waveform setup.....	100
6.1	Horizontal setup.....	100
6.1.1	About the horizontal system.....	100
6.1.2	Horizontal Setup settings.....	101
6.1.3	Zoom settings.....	102
6.1.4	Roll mode.....	102
6.1.5	Reference clock.....	104
6.2	Acquisition.....	104
6.2.1	About the acquisition system.....	105
6.2.2	Acquisition Setup settings.....	106
6.2.3	Segmentation settings.....	110
6.2.4	High definition mode.....	111
6.2.5	History settings.....	112
6.2.6	Speed.....	112

6.3 Vertical setup.....	113
6.3.1 About the vertical system.....	114
6.3.2 Vertical Setup settings.....	114
6.3.3 Bandwidth settings.....	117
6.3.4 Probe settings.....	118
6.3.5 Other vertical settings.....	118
6.4 Probes.....	119
6.4.1 Common probe settings.....	119
6.4.2 Setup for passive probes.....	122
6.4.3 Setup for active voltage probes.....	123
6.4.4 Setup for current probes.....	129
6.4.5 Probe info.....	131
6.4.6 Adjusting passive probes.....	132
7 Trigger.....	134
7.1 Basics of triggering.....	134
7.1.1 Trigger information.....	135
7.2 Common trigger settings.....	135
7.3 Trigger types.....	137
7.3.1 Edge trigger.....	138
7.3.2 Edge trigger on external trigger source.....	138
7.3.3 Glitch trigger.....	140
7.3.4 Width trigger.....	142
7.3.5 Runt trigger.....	143
7.3.6 Window trigger.....	145
7.3.7 Timeout trigger.....	147
7.3.8 Interval trigger.....	148
7.3.9 Slew rate trigger.....	150
7.3.10 Line trigger.....	152
7.4 Trigger mode / holdoff.....	152
7.5 Hysteresis.....	155
7.6 Channel filter.....	156
7.7 Actions on trigger.....	157
8 Waveform analysis.....	160

8.1 Zoom	160
8.1.1 Zoom settings.....	160
8.1.2 Zooming for details.....	163
8.2 Mathematics	164
8.2.1 Displaying math waveforms.....	165
8.2.2 Math waveforms settings.....	165
8.2.3 Math filter.....	168
8.2.4 Math scale settings.....	169
8.3 History	170
8.3.1 About history.....	170
8.3.2 History setup.....	171
8.3.3 Quick access history dialog.....	173
8.3.4 Using history.....	174
8.4 Reference waveforms	176
8.4.1 Working with reference waveforms.....	176
8.4.2 Settings for reference waveforms.....	177
9 Measurements	184
9.1 Cursor measurements	184
9.1.1 Cursors and results of cursor measurements.....	184
9.1.2 Using cursors.....	185
9.1.3 Settings for cursor measurements.....	187
9.2 Automatic measurements	193
9.2.1 Measurement results.....	196
9.2.2 Gate settings for measurements.....	197
9.2.3 Reference level.....	199
9.2.4 Measurement types.....	202
9.2.5 Settings for measurements.....	204
9.2.6 Statistics.....	211
9.2.7 Track.....	213
10 Spectrum analysis	218
10.1 Fundamentals of spectrum analysis	218
10.2 Configuring spectrum waveforms	220
10.3 Spectrum setup	222

10.4	Spectrum scale	225
10.5	Spectrum gate	226
10.6	Spectrum peak list	227
11	Applications	231
11.1	Frequency response analysis (option R&S MXO5-K36)	231
11.1.1	About the frequency response analysis plot.....	232
11.1.2	Using a frequency response analysis.....	233
11.1.3	Settings for frequency response analysis.....	234
11.1.4	FRA saving results.....	244
11.1.5	Dependencies of the measurement setup.....	245
11.2	Power analysis (option R&S MXO5-K31)	246
11.2.1	Power measurement selection.....	246
11.2.2	Power measurements.....	248
11.2.3	Reference level.....	259
11.2.4	Deskew.....	261
11.2.5	Offset compensation.....	262
11.3	Digital voltmeter	263
11.3.1	Using the digital voltmeter.....	263
11.3.2	Settings of the digital voltmeter.....	264
12	Data and file management	266
12.1	Save and recall user settings	267
12.1.1	Using savesets.....	267
12.1.2	Gen saveset.....	269
12.2	Save and recall waveform data	271
12.2.1	Waveform settings.....	271
12.2.2	Saving waveforms.....	273
12.2.3	Waveform export files.....	274
12.3	Saving results	279
12.4	Screenshots	280
12.4.1	Screenshot settings.....	281
12.4.2	Configuring and saving screenshots.....	283
12.5	File browser dialog	283

13	Protocol analysis.....	285
13.1	Basics of protocol analysis.....	285
13.1.1	Setup - general settings.....	286
13.1.2	Advanced.....	288
13.1.3	Display.....	288
13.1.4	Filter.....	289
13.1.5	Trigger.....	289
13.1.6	Shortcuts.....	290
13.1.7	Export protocol results.....	291
13.1.8	Bit pattern editor.....	292
13.2	SPI bus (option R&S MXO5-K510).....	293
13.2.1	About the SPI protocol.....	293
13.2.2	SPI configuration.....	294
13.2.3	SPI filter.....	298
13.2.4	SPI trigger.....	301
13.2.5	SPI decode results.....	303
13.2.6	Performing SPI decoding.....	305
13.3	I²C (option R&S MXO5-K510).....	309
13.3.1	About the I ² C protocol.....	309
13.3.2	I ² C configuration.....	311
13.3.3	I ² C filter.....	314
13.3.4	I ² C trigger settings.....	316
13.3.5	I ² C decode results.....	320
13.3.6	Performing I ² C decoding.....	322
13.4	UART (option R&S MXO5-K510).....	326
13.4.1	About the UART / RS-232 interface.....	326
13.4.2	UART configuration.....	327
13.4.3	UART filter.....	331
13.4.4	UART trigger.....	333
13.4.5	UART decode results.....	335
13.4.6	Performing UART decoding.....	336
13.5	CAN (option R&S MXO5-K520).....	340
13.5.1	CAN configuration.....	340

13.5.2	CAN filter.....	346
13.5.3	CAN trigger settings.....	349
13.5.4	CAN decode results.....	358
13.5.5	Performing CAN decoding.....	360
13.6	LIN (option R&S MXO5-K520).....	365
13.6.1	LIN configuration.....	366
13.6.2	LIN trigger settings.....	368
13.6.3	LIN filter.....	370
13.6.4	LIN decode results.....	373
13.6.5	Performing LIN decoding.....	375
14	Mixed signal option (MSO, R&S MXO5-B1).....	378
14.1	Logic configuration.....	378
14.1.1	Setup.....	378
14.1.2	Bus.....	381
14.1.3	Label settings.....	382
14.1.4	Skew settings.....	383
14.2	Display.....	384
14.2.1	Logic bus - decode table.....	385
15	Waveform generator (option R&S MXO5-B6).....	386
15.1	Setup of the waveform generator.....	386
15.1.1	General settings.....	386
15.1.2	Modulation settings.....	394
15.1.3	Sweep settings.....	397
15.1.4	Arbitrary waveforms.....	398
15.2	Synchronize settings.....	402
15.3	Configuring the waveform generator.....	403
15.3.1	Configuring a function waveform.....	403
15.3.2	Configuring a modulation waveform.....	403
15.3.3	Configuring a sine sweep waveform.....	405
15.3.4	Configuring an arbitrary waveform.....	405
16	Network operation and remote control.....	407
16.1	Connecting the instrument to the network (LAN).....	407

16.1.1	Connecting the instrument to the network.....	408
16.1.2	Assigning the IP address.....	408
16.1.3	Using host names.....	409
16.2	Web interface.....	410
16.2.1	Settings on the R&S MXO 5.....	410
16.2.2	Web browser.....	410
16.3	Remote operation with VNC client.....	415
16.4	Remote control.....	415
16.4.1	Remote control interfaces and protocols.....	415
16.4.2	Starting and stopping remote control.....	417
16.5	Remote control - status reporting system.....	418
16.5.1	Hierarchy of status registers.....	418
16.5.2	Structure of a SCPI status register.....	420
16.5.3	Contents of the status registers.....	421
16.5.4	Error queue.....	426
16.5.5	Reset values of the status reporting system.....	426
17	Remote control commands.....	428
17.1	Conventions used in remote command description.....	428
17.2	Finding the appropriate command.....	429
17.3	Frequently used parameters and suffixes.....	429
17.3.1	Waveform parameter.....	429
17.3.2	Slope parameter.....	430
17.3.3	Polarity parameter.....	430
17.4	Programming examples.....	430
17.4.1	SmartGrid layout with zoom.....	430
17.4.2	Saving screenshots to file.....	434
17.4.3	Data transfer in roll mode.....	435
17.5	Common commands.....	435
17.6	General remote settings.....	439
17.7	Instrument setup.....	441
17.7.1	System.....	441
17.7.2	SmartGrid.....	443
17.7.3	Toolbar.....	448

17.7.4	Appearance.....	449
17.7.5	Display.....	453
17.7.6	Maintenance.....	459
17.8	Acquisition and setup.....	460
17.8.1	Starting and stopping acquisition.....	460
17.8.2	Horizontal setup.....	461
17.8.3	Roll mode.....	463
17.8.4	Vertical setup.....	464
17.8.5	Waveform data export.....	469
17.8.6	Acquisition setup.....	471
17.8.7	Fast segmentation.....	476
17.8.8	Probes.....	476
17.8.9	High definition mode.....	490
17.8.10	Reference clock.....	491
17.9	Trigger.....	492
17.9.1	Common trigger settings.....	493
17.9.2	Edge trigger.....	494
17.9.3	Glitch trigger.....	497
17.9.4	Width trigger.....	498
17.9.5	Runt trigger.....	499
17.9.6	Window trigger.....	502
17.9.7	Timeout trigger.....	505
17.9.8	Interval trigger.....	506
17.9.9	Slew rate trigger.....	507
17.9.10	Trigger mode, holdoff.....	510
17.9.11	Hysteresis.....	513
17.9.12	Channel filter.....	515
17.9.13	Actions on trigger.....	516
17.10	Waveform analysis.....	518
17.10.1	Zoom.....	518
17.10.2	Mathematics.....	526
17.10.3	History.....	531
17.10.4	Reference waveforms.....	534

17.11	Data management.....	543
17.11.1	Instrument settings.....	543
17.11.2	Saveset.....	550
17.11.3	Gen saveset.....	550
17.11.4	Waveform export to file.....	550
17.11.5	Results.....	553
17.11.6	Screenshots.....	554
17.12	Automatic measurements.....	557
17.12.1	General settings.....	557
17.12.2	Measurement-specific settings.....	560
17.12.3	Results.....	563
17.12.4	Statistics.....	566
17.12.5	Gate.....	568
17.12.6	Reference levels.....	571
17.12.7	Tracks.....	575
17.13	Cursor measurements.....	577
17.13.1	Cursor setup.....	578
17.13.2	Cursor results.....	584
17.13.3	Peak search using cursors.....	585
17.13.4	Cursor appearance.....	587
17.14	Spectrum analysis.....	588
17.14.1	Spectrum setup.....	588
17.14.2	Spectrum gate.....	596
17.14.3	Peak list.....	597
17.14.4	Data export of spectrum waveforms.....	601
17.15	Applications.....	603
17.15.1	Frequency response analysis (option R&S MXO5-K36).....	603
17.15.2	Power analysis (option R&S MXO5-K31).....	618
17.15.3	Digital voltmeter.....	641
17.16	Protocols.....	644
17.16.1	Configuration settings for all serial protocols.....	644
17.16.2	SPI (option R&S MXO5-K510).....	648
17.16.3	I ² C (option R&S MXO5-K510).....	666

17.16.4	UART / RS-232 (option R&S MXO5-K510).....	685
17.16.5	CAN (option R&S MXO5-K520).....	700
17.16.6	LIN (option R&S MXO5-K520).....	733
17.17	Mixed signal option (option R&S MXO5-B1).....	749
17.17.1	Digital channels.....	749
17.17.2	Logic configuration.....	752
17.17.3	MSO data.....	759
17.18	Waveform generator (option R&S MXO5-B6).....	761
17.18.1	Waveform generator setup.....	762
17.18.2	Synchronize settings.....	779
17.19	Status reporting.....	780
17.19.1	General commands.....	781
17.19.2	STATus:OPERation register.....	781
17.19.3	STATus:QUEStionable registers.....	782
17.19.4	Reading out the CONDition part.....	784
17.19.5	Reading out the EVENt part.....	785
17.19.6	Controlling the ENABLE part.....	785
17.19.7	Controlling the negative transition part.....	786
17.19.8	Controlling the positive transition part.....	787
17.19.9	Programming tips and examples.....	788
18	Maintenance and support.....	791
18.1	Cleaning.....	791
18.2	Changing fuses.....	791
18.3	Contacting customer support.....	791
18.4	Information for technical support.....	792
18.5	Data security.....	792
18.6	Transporting.....	793
18.7	Storage.....	793
18.8	Disposal.....	793
	List of commands.....	795
	Index.....	820

1 Safety and regulatory information

The product documentation helps you to use the product safely and efficiently.

Where do I find safety information?

Safety information is part of the product documentation. It warns you of potential dangers and gives instructions on how to prevent personal injury or damage caused by dangerous situations. Safety information is provided as follows:

- In [Chapter 1.1, "Safety instructions"](#), on page 15. The same information is provided in many languages in printed format. The printed "Safety Instructions for Oscilloscopes and Accessories" are delivered with the product.
- Throughout the documentation, safety instructions are provided when you need to take care during setup or operation.

Intended use

The R&S MXO 5 oscilloscope is designed for measurements on circuits that are only indirectly connected to the mains or not connected at all. It is not rated for any measurement category.

The product is intended for the development, production and verification of electronic components and devices in industrial, administrative, and laboratory environments. Use the product only for its designated purpose. Observe the operating conditions and performance limits stated in the data sheet.

1.1 Safety instructions

Products from the Rohde & Schwarz group of companies are manufactured according to the highest technical standards. To use the products safely, follow the instructions provided here and in the product documentation. Keep the product documentation nearby and offer it to other users.

Use the product only for its intended use and within its performance limits. Intended use and limits are described in the product documentation such as the data sheet, manuals and the printed "Safety Instructions for Oscilloscopes and Accessories" document. If you are unsure about the appropriate use, contact Rohde & Schwarz customer service.

Using the product requires specialists or specially trained personnel. These users also need sound knowledge of at least one of the languages in which the user interfaces and the product documentation are available.

Reconfigure or adjust the product only as described in the product documentation or the data sheet. Any other modifications can affect safety and are not permitted.

Never open the casing of the product. Only service personnel authorized by Rohde & Schwarz are allowed to repair the product. If any part of the product is damaged or broken, stop using the product. Contact Rohde & Schwarz customer service at <https://www.rohde-schwarz.com/support>.

In these safety instructions, the term "product" covers instruments (oscilloscopes), probes and their accessories.

Lifting and carrying the instrument

Check the data sheet for the maximum weight of the instrument. A single person can only carry a maximum of 18 kg safely depending on age, gender and physical condition. If your instrument is heavier than 18 kg, do not move or carry it by yourself.

Use the instrument handles to move or carry the instrument. Do not use the mounted accessories instead of the handles. Accessories are not designed to carry the weight of the instrument.

To move the instrument safely, you can use lifting or transporting equipment such as lift trucks and forklifts. Follow the instructions provided by the equipment manufacturer.

Choosing the operating site

Only use the product indoors. The product casing is not waterproof. Water that enters can electrically connect the casing with live parts, which can lead to electric shock, serious personal injury or death if you touch the casing. If Rohde & Schwarz provides accessories designed for outdoor use of your product, e.g. a protective cover, you can use the product outdoors.

Unless otherwise specified in the data sheet, you can operate the product up to an altitude of 2000 m above sea level.

The product is suitable for pollution degree 2 environments where nonconductive contamination can occur. For more information on environmental conditions such as ambient temperature and humidity, see the data sheet.

Setting up the product

Always place the product on a stable, flat and level surface with the bottom of the product facing down. If the product is designed for different positions, secure the product so that it cannot fall over.

If the product has foldable feet, always fold the feet completely in or out to ensure stability. The feet can collapse if they are not folded out completely or if the product is moved without lifting it. The foldable feet are designed to carry the weight of the product, but not an extra load.

If stacking is possible, keep in mind that a stack of products can fall over and cause injury.

If you mount products in a rack, ensure that the rack has sufficient load capacity and stability. Observe the specifications of the rack manufacturer. Always install the products from the bottom shelf to the top shelf so that the rack stands securely. Secure the product so that it cannot fall off the rack.

Connecting the product

Unless specified otherwise in the data sheet, only connect the interfaces and measurement ports of the product to other products or circuits that have double or reinforced

insulation to protect against dangerous live voltages. This protective measure against electric shock is known as SELV (safety extra-low voltage).

Connecting to power and grounding

The mains power supply input of the instrument complies with overvoltage category II. Connect the product to a fixed installation used to supply energy-consuming equipment such as household appliances and similar loads. Keep in mind that electrically powered products have risks, such as electric shock, fire, personal injury or even death.

Take the following measures for your safety:

- Do not use an isolating transformer to connect the instrument to the mains power supply.
- Before switching on the product, ensure that the voltage and frequency indicated on the product match the available power source. If the power adapter does not adjust automatically, set the correct value and check the rating of the fuse.
- If a product has an exchangeable fuse, its type and characteristics are indicated next to the fuse holder. Before changing the fuse, switch off the product and disconnect it from the power source. How to change the fuse is described in the product documentation.
- Only use the power cable delivered with the product. It complies with country-specific safety requirements. Only insert the plug into an outlet with protective conductor terminal.
- Only use intact cables and route them carefully so that they cannot be damaged. Check the power cables regularly to ensure that they are undamaged. Also ensure that nobody can trip over loose cables.
- If you connect the product to an external power supply, use the one delivered with the product or recommended in the product documentation. The external power supply must conform to the country-specific regulations.
- Ensure that you can disconnect the product from the power source at any time. Pull the power plug to disconnect the product. The power plug must be easily accessible. If the product is integrated into a system that does not meet these requirements, provide an easily accessible circuit breaker at the system level.
- Replace parts that are relevant to safety only by original parts, e.g. power cables or fuses.

Performing measurements

Take the following measures for your safety:

- To ascertain voltage-free state, use an appropriate voltage tester. Any measurement setup including an oscilloscope is not suitable for this purpose.
- The maximum input voltage on channel inputs and the external trigger input must not exceed the value specified in the data sheet.
- Observe all voltage and current ratings of the instrument, the probes, and the accessories. Exceeding the allowed voltages can lead to an electric shock. Limits and ratings are marked on the products and listed in the data sheets. Consider that the rated voltage depends on the frequency. The voltage limitation curves or values are provided in the data sheet.

- Never cause any short circuits when measuring sources with high output currents.
- Use only probes and accessories that comply with the measurement category (CAT) of your measurement task. If the product is rated for any measurement category, the permitted category is indicated on the product and in the data sheet. If you use other than Rohde & Schwarz accessories, make sure that they are suitable for the instrument and the measurement task.
- Set the correct attenuation factor on the instrument according to the probe being used. Otherwise, the measurement results do not reflect the actual voltage level, and you might misjudge the actual risk.
- When working with high voltages and current probes, observe the additional operating conditions specified in these safety instructions.
- The probe pins are extremely pointed and can easily penetrate clothes and the skin. Handle the probe pins with great care. To exchange a probe pin, use tweezers or pliers to avoid injuries. When transporting the accessories, always use the box supplied with the probe.
- Prevent the probe from receiving mechanical shock. Avoid putting excessive strain on the probe cable or exposing it to sharp bends. Touching a broken cable during measurements can cause injuries.
- Set up all probe connections to the instrument before applying power.

Working with hazardous voltages

Voltages higher than 30 V RMS, or 42 V peak, or 60 V DC are regarded as hazardous contact voltages. Direct contact with them can cause serious injuries.

Make sure that only electrically skilled persons use the products for measurements on hazardous contact voltages. These working conditions require special education and experience to perceive risks and to avoid hazards which electricity can create.

When working with hazardous contact voltages, use protective measures to preclude direct contact with the measurement setup:

- Do not touch exposed connections and components when power is applied.
- Switch off the test circuit while connecting and disconnecting probe leads.
- Use only insulated voltage probes, test leads and adapters.
- Make sure that the input leads fulfill the safety requirements for your measurement. The delivered input leads might have a jacket wear indicator that indicates a worn jacket by different jacket color. In this case, do not use the input lead. Replace it with a new one.
- When connecting to the DUT, keep your fingers behind finger guard. Remove jewelry, watches, and other metallic objects. Only use 4 mm safety banana plugs.

Working with current probes

When working with current probes, you can measure high-frequency currents or currents that contain high-frequency components.

- Switch off the test circuit while connecting the probe.

- Do not attach the clamp to bare unisolated conductors. To avoid injury from a short circuit, measure at a location on an insulated wire where the insulation is sufficient for the circuit voltage.
- Connect the probe only to the secondary side of a breaker. With this measure, you avoid injury, if a short circuit occurs.
- The following effects can cause burns and fire or damage to the measurement site:
 - Eddy current loss can cause heating of the sensor head.
 - Dielectric heating can cause heating of cord insulation and other materials.
- When measuring current that includes a high-frequency component, consider the derating characteristics of the probe. Do not measure any current that exceeds the rated current.
- Using the probes with high frequencies or strong magnetic fields may cause the device to become abnormally hot, resulting in fire, equipment damage, or burns.

Measurement categories

IEC 61010-2-030 defines measurement categories that rate instruments on their ability to resist short transient overvoltages that occur in addition to the working voltage. Use the measurement setup only in electrical environments for which they are rated.

- 0 - Instruments without rated measurement category
For measurements performed on circuits not directly connected to mains, for example, electronics, circuits powered by batteries, and specially protected secondary circuits. This measurement category is also known as CAT I.
- CAT II:
For measurements performed on circuits directly connected to the low-voltage installation by a standard socket outlet, for example, household appliances and portable tools.
- CAT III:
For measurements performed in the building installation, such as junction boxes, circuit breakers, distribution boards, and equipment with permanent connection to the fixed installation.
- CAT IV:
For measurements performed at the source of the low-voltage installation, such as electricity meters and primary overcurrent protection devices.

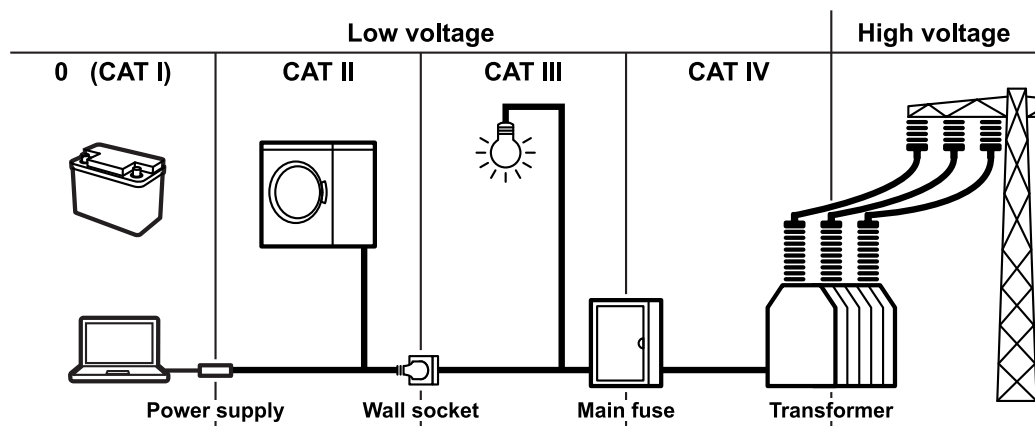





Cleaning the product

Use a dry, lint-free cloth to clean the product. When cleaning, keep in mind that the casing is not waterproof. Do not use liquid cleaning agents.

Meaning of safety labels

Safety labels on the product warn against potential hazards.



	<p>Potential hazard</p> <p>Read the product documentation to avoid personal injury or product damage.</p>
	<p>Electrical hazard</p> <p>Indicates live parts. Risk of electric shock, fire, personal injury or even death.</p>
	<p>Protective conductor terminal</p> <p>Connect this terminal to a grounded external conductor or to protective ground. This connection protects you against electric shock if an electric problem occurs.</p>
	<p>Hazardous contact voltages</p> <p>Do not use the probe at uninsulated live lines. Make sure to measure at sufficiently insulated conductors. This measure protects you against electric shock, electric burn, or arc flash.</p>

1.2 Labels on the product

Labels on the casing inform about:

- Personal safety, see "[Meaning of safety labels](#)" on page 20
- Product and environment safety, see [Table 1-1](#)
- Identification of the product

Table 1-1: Labels regarding product and environment safety

	<p>Chassis grounding terminal</p>
	<p>Take care when handling electrostatic sensitive devices.</p>
	<p>Labeling in line with EN 50419 for disposal of electrical and electronic equipment after the product has come to the end of its service life.</p> <p>For more information, see "Disposing of electrical and electronic equipment" on page 793.</p>

1.3 Warning messages in the documentation

A warning message points out a risk or danger that you need to be aware of. The signal word indicates the severity of the safety hazard and how likely it will occur if you do not follow the safety precautions.

WARNING

Potentially hazardous situation. Could result in death or serious injury if not avoided.

CAUTION

Potentially hazardous situation. Could result in minor or moderate injury if not avoided.

NOTICE

Potential risks of damage. Could result in damage to the supported product or to other property.

1.4 Where to find key documents on Rohde & Schwarz

Certificates issued to Rohde & Schwarz that are relevant for your country are provided at www.rohde-schwarz.com/key-documents, e.g. concerning:

- Quality management
- Environmental management
- Information security management
- Accreditations

1.5 Korea certification class A



이 기기는 업무용(A급) 전자파 적합기기로서 판매자 또는 사용자는 이 점을 주의하시기 바라며, 가정외의 지역에서 사용하는 것을 목적으로 합니다.

2 Preface

2.1 Key features

The R&S MXO 5 series oscilloscope is a next generation oscilloscope with 4 or 8 channels, evolved for more challenges.

Using the R&S MXO 5, you can:

- Acquire, process and display signals with unrivaled speed.
- Detect signal details, faults and anomalies instantly.
- Increase your statistical confidence.

The R&S MXO 5 series oscilloscopes utilize advanced technologies:

- Fastest update rate of up to 4.5 million waveforms/s thanks to MXO-EP ASIC
- 12 bit ADC at all sample rates, and 18 bit vertical resolution in HD mode
- Bandwidth up to 2 GHz, and up to 5 Gsample/s sample rate
- Deepest standard memory: 500 Mpoints per channel
- High-precision digital trigger with best-in-class trigger jitter, also available in HD mode
- Nearly zero blind time: up to 99% real-time signal activity capture
- Lowest measurement noise
- Eco-friendly design: low power consumption, automatic power-up capability, scarcely audible

Features and applications help achieve fast and accurate results, for example:

- Segmented memory & history mode to analyze previous acquisitions
- Superior spectrum analysis with 45 000 FFT/s, which allows capture of spurious spectrum events
4 simultaneous spectrums with independent time and frequency control
- Integrated arbitrary waveform generator
- Logic analysis with 16 digital channels
- Dual-path serial protocol analysis
- Frequency response analysis (Bode plots)
- Large high-resolution touchscreen, R&S SmartGrid, configurable toolbar, intuitive navigation
- Wide selection of compatible probes

2.2 Options described in this document

In addition to the base unit, the following options are described in this documentation:

Options described in this document

Type	Designation	Order No.
R&S MXO5-B1	MSO	
R&S MXO5-B6	Waveform and pattern generator	1802.0753.02
R&S MXO5-K31	Power analysis	1802.0799.02
R&S MXO5-K36	Frequency response analysis	1802.1943.02
R&S MXO5-K510	Triggering and decoding low speed serial buses: I2C, SPI, UART/RS-232/RS-422/ RS-485	1802.1243.02
R&S MXO5-K520	Triggering and decoding automotive protocols: LIN, CAN, CAN FD, CAN XL	1802.1920.02

3 Getting Started

3.1 Preparing for use

Here, you can find basic information about setting up the instrument for the first time or when changing the operating site.

3.1.1 Lifting and carrying

See: "[Lifting and carrying the instrument](#)" on page 16.

3.1.2 Unpacking and checking

1. Unpack the product carefully.
2. Retain the original packing material. Use it when transporting or shipping the product later.
3. Using the delivery notes, check the equipment for completeness.
4. Check the equipment for damage.

If the delivery is incomplete or equipment is damaged, contact Rohde & Schwarz.

3.1.3 Choosing the operating site

Specific operating conditions ensure proper operation and avoid damage to the product and connected devices. For information on environmental conditions such as ambient temperature and humidity, see the data sheet.

For safety information, see "[Choosing the operating site](#)" on page 16.

Electromagnetic compatibility classes

The electromagnetic compatibility (EMC) class indicates where you can operate the product. The EMC class of the product is given in the data sheet.

- Class B equipment is suitable for use in:
 - Residential environments
 - Environments that are directly connected to a low-voltage supply network that supplies residential buildings
- Class A equipment is intended for use in industrial environments. It can cause radio disturbances in residential environments due to possible conducted and radiated disturbances. It is therefore not suitable for class B environments.

If class A equipment causes radio disturbances, take appropriate measures to eliminate them.

3.1.4 Setting up the product

When setting up the instrument, follow the safety instructions:

- "Setting up the product" on page 16
- "Intended use" on page 15

3.1.4.1 Placing the product on a bench top

For standalone operation, place the instrument on a horizontal bench with even, flat surface. The instrument can be used in horizontal position, standing on its feet, or with the support feet on the bottom extended.

To place the product on a bench top

1. Place the product on a stable, flat and level surface.
2. **CAUTION!** The top surface of the product is too small for stacking. If you stack another product on top of the product, the stack can fall over and cause injury.

If you want to save space, mount several products in a rack.

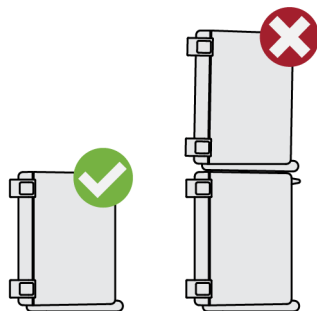

3. **CAUTION!** Foldable feet can collapse. For safety information, see "Setting up the product" on page 16.

Always fold the feet completely in or out. With folded-out feet, do not place anything on top or underneath.

4. **NOTICE!** Overheating can damage the product.

Prevent overheating as follows:

- Keep a minimum distance of 10 cm between the fan openings of the product and any object in the vicinity to provide sufficient airflow and ventilation.
- Do not place the product next to heat-generating equipment such as radiators or other products.

3.1.4.2 Mounting the product on a monitor arm

You can mount the oscilloscope to a monitor arm with VESA mount.

1. **NOTICE!** Only use a VESA mount compatible to FDMI MIS-D, up to 14kg with M4x10 screws and standard 100 mm × 100 mm pattern.
Order the VESA adapter R&S MXO5-Z7. For the order number, see data sheet.
2. Mount the adapter to the rear panel of the oscilloscope. Follow the assembly instructions provided with the adapter.
3. Mount the VESA mount of the monitor arm to the VESA adapter.

3.1.4.3 Mounting the product in a rack

The instrument can be installed in a rack using a rack adapter kit. The order number is given in the data sheet. The installation instructions are part of the adapter kit.

To prepare the rack

1. Observe the requirements and instructions in "[Setting up the product](#)" on page 16.
2. **NOTICE!** Insufficient airflow can cause overheating and damage the product.
Design and implement an efficient ventilation concept for the rack.

To mount the oscilloscope in a rack

1. Use an adapter kit to prepare the product for rack mounting.
 - a) Order the rack adapter kit designed for the R&S MXO 5 series oscilloscope.
For the order number, see data sheet.
 - b) Mount the adapter kit. Follow the assembly instructions provided with the adapter kit.
2. Lift the product to shelf height. If the rack is high, use a safe climbing aid when placing on upper shelves.
3. Grip the product by the handles. Slide the product onto the shelf until the rack brackets fit closely to the rack.
4. Tighten all screws at the rack brackets with a tightening torque of 1.2 Nm to secure the product at the rack.

To unmount the product from a rack

1. Loosen the screws at the rack brackets.
2. Remove the product from the rack.
3. If placing the product on a bench top again, unmount the adapter kit from the product. Follow the instructions provided with the adapter kit.

3.1.5 Considerations for test setup

Observe safety instructions, see "[Performing measurements](#)" on page 17.

Cable selection and electromagnetic interference (EMI)

Electromagnetic interference (EMI) can affect the measurement results.

To suppress electromagnetic radiation during operation:

- Use high-quality shielded cables, for example, double-shielded RF and LAN cables.
- Always terminate open cable ends.
- Ensure that connected external devices comply with EMC regulations.

Measuring accessories

Use only probes and measuring accessories that comply with IEC 61010-031.

Signal input and output levels

Information on signal levels is provided in the data sheet. Keep the signal levels within the specified ranges to avoid damage to the product and connected devices.

During operation, if the firmware observes a serious unexpected disturbance (e.g. due to ESD), it resets some hardware components and initiates a new alignment to ensure proper instrument functioning. Then it restores the user settings to the state before the disturbance.

3.1.6 Connecting to power

For safety information, see "[Connecting to power and grounding](#)" on page 17.

The R&S MXO 5 can be used with different AC power voltages and adapts itself automatically to it.

The nominal ranges are indicated on a label near the power connector on the instrument and in the data sheet.

1. Plug the AC power cable into the AC power connector on the rear panel of the product. Only use the AC power cable that is delivered with the product.
2. Plug the AC power cable into a power outlet with ground contact.

The required ratings are listed next to the AC power connector and in the data sheet.

If the voltage dips at the AC power connector (according to EN 61326-2-1 6.4.101), a restart of the R&S MXO 5 can happen. All instrument settings are restored after the restart.

3.1.7 Connecting to LAN

For remote operation of the instrument using a computer, you need a local area network (LAN) connection.

Network environment

Before connecting the product to a LAN, consider the following:

- Install the latest firmware to reduce security risks.
- For internet or remote access, use secured connections if applicable.
- Ensure that the network settings comply with the security policies of your company. Contact your local system administrator or IT department before connecting your product to your company LAN.
- When connected to the LAN, the product may potentially be accessed from the internet, which may be a security risk. For example, attackers might misuse or damage the product.

To connect a LAN cable

- ▶ Connect an RJ-45 cable to the LAN connector on the rear panel, and to the LAN.

For supported LAN interfaces, refer to the data sheet.

By default, the R&S MXO 5 is configured to use DHCP. Configuration of a static IP address is not required.

3.1.8 Connecting external devices

3.1.8.1 Connecting USB devices

You can use USB connectors on the front panel and on the side or rear panel to connect various devices:

- Connect a keyboard and a mouse for operation and data entry, alternatively or in addition to the touchscreen functionality.
 - Connect USB flash drives to save screenshots, and to transfer files to and from the instrument without a network connection.
- ▶ Connect the USB device to any of the USB connectors.

You can connect or disconnect USB devices during operation of the instrument.

3.1.8.2 Connecting external monitors

Using the HDMI or DisplayPort connector on the side panel, you can connect one external monitor or projector to the oscilloscope. The display connectors are *not* plug & play, the monitor is recognized by the instrument during the boot process.

1. **NOTICE!** Missing ground contact can damage the oscilloscope.
Ensure that the monitor and the oscilloscope are connected to a ground contact.
See also: [Chapter 3.1.6, "Connecting to power"](#), on page 27.
2. **NOTICE!** Use only standard-compliant monitor cables.
Connect the monitor or projector to a monitor connector on the rear panel.
3. Switch on the oscilloscope. See also "[To switch on the product](#)" on page 29.

The oscilloscope recognizes the external monitor. During the running session, you can disconnect the monitor and connect it again.

If the monitor provides touch functionality, an additional connection can be required, e.g. a USB connection. Refer to the documentation of your monitor.

The oscilloscope outputs a Full HD image with 1920x1080 pixel. The instrument's display is duplicated. If the screen resolution of the monitor is set higher than the instrument's resolution, the application window uses a 1920x1080 area of the monitor display. For full screen display, adjust the monitor's screen resolution.

3.1.9 Switching on or off

The instrument is switched on or off with the power switch and the [Power] key. The [Power] key is located in the bottom left corner of the front panel. The power switch is located at the rear panel of the instrument.

Table 3-1: Overview of power states

Status	LED	Power switch
Off	● (unlighted)	[0] (off)
Standby	● yellow	[1] (on)
Ready	● green	[1] (on)

To switch on the product

The product is off but connected to power.

1. Set the switch on the power supply to position [1].
The power key on the front panel lights up.
2. Press the [Power] key on the front panel.
The instrument performs a system check, boots the operating system, and then starts the R&S MXO 5 firmware.
The [Power] key turns green and the illuminated keys on the front panel light up. If the previous session was terminated regularly, the oscilloscope uses the last settings.

Before you start measurements, be sure to comply with the warm-up phase specified in the data sheet.

To shut down the product

The product is in the ready state.

- ▶ Press the [Power] key.

All current settings are saved, and the software shuts down. The [Power] key turns yellow. The standby power supplies only the power switch circuits.

The  "Power" icon in the "Menu" shuts down only the firmware application. To shut down the instrument completely, use the [Power] key.

Remote command for firmware shutdown: `SYSTem:EXIT` on page 442.

To disconnect from power

The product is in the standby state.

1. **NOTICE!** Risk of data loss. If you disconnect the product from power when it is in the ready state, you can lose settings and data. Shut it down first.
Set the switch on the power supply to position [0].
The LED of the [Power] key is switched off.
2. Disconnect the product from the power source.

3.2 Instrument tour

This section describes the front, rear and side view of the instrument including all function keys and connectors.

3.2.1 Front view

This section provides an overview of the R&S MXO 5 front panel.



Figure 3-1: Front view of R&S MXO 558, with 8 input channels

- 1 = Display
- 2 = Keys and controls
- 3 = Analog input channels
- 4 = Connectors for demo signal output
- 5 = Connectors for logic probe (R&S MXO5-B1 Mixed Signal Option)
- 6 = [Power] key
- 7 = USB connectors
- 8 = Connectors for probe compensation

Analog channel inputs

The R&S MXO 5 has 4 or 8 channel inputs to connect the input signals, depending on the model.

You can connect probes with Rohde & Schwarz probe interface or BNC connectors. The input impedance is selectable, the values are 50 Ω and 1 M Ω .

The maximum input voltage on channel inputs is:

- 400 V (V_p) and 300 V (RMS) at 1 M Ω input impedance
- 30 V (V_p) and 5 V (RMS) at 50 Ω input impedance

Demo

The pins are intended for demonstration purposes.

Logic Channels

Two connectors for logical probes with 8 digital channels each (D0 to D7 and D8 to D15). Using logic channels requires the Mixed Signal Option R&S MXO5-B1.



The maximum input voltage is 40 V (Vp) at 100 k Ω input impedance. The maximum input frequency for a signal with the minimum input voltage swing and medium hysteresis of 800 mV (Vpp) is 400 MHz.

USB

Three USB 3.1 gen1 interfaces of type A. They are used to connect a mouse or keyboard, a USB flash drive for storing and reloading instrument settings and measurement data, and to update the firmware.

Probe Comp.

Probe compensation terminal to adjust passive probes to the input channel.

-  Square wave signal for probe compensation.
-  Ground connector for probes.

3.2.2 Side view

On the side of the instrument, you can find the computer connectors and the ground connector for probes.

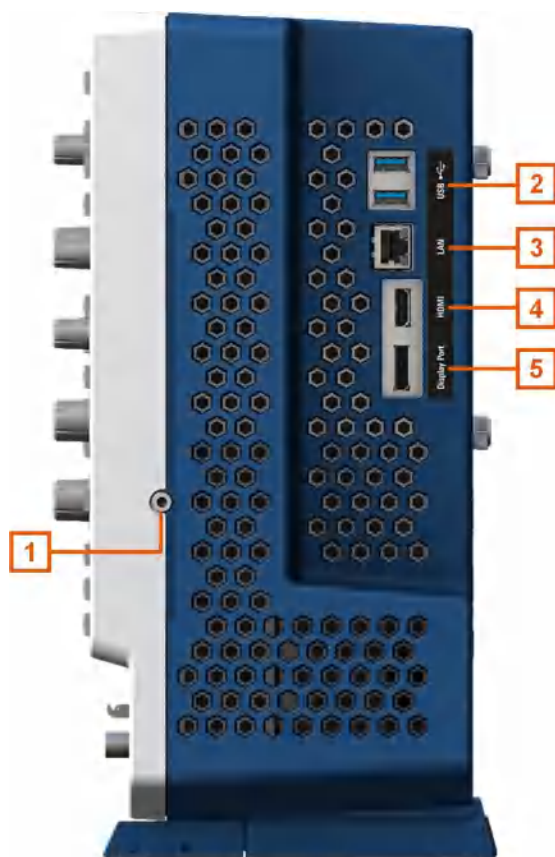

Figure 3-2: Side view of R&S MXO 5

- 1 = Grounding terminal
- 2 = USB connector
- 3 = LAN connector
- 4 = HDMI display output
- 5 = DisplayPort connector

Grounding terminal

4 mm banana jack to connect ground of DUT and test fixtures, and wrist strap.

USB

Two USB 3.1 gen1 interfaces of type A.

LAN

8-pin connector RJ-45 used to connect the instrument to a Local Area Network (LAN). It supports up to 1 Gbit/s.

HDMI

HDMI Version 2.0 connector for an external monitor or projector. The monitor shows the complete content of the instrument's screen.

DisplayPort

DisplayPort connector for an external monitor or projector. It supports DisplayPort++ version 1.3.

3.2.3 Rear view

On the rear panel of the R&S MXO 5, you find more connectors and the power supply switch.



Figure 3-3: Rear panel view of R&S MXO 5

USB Device	= USB connector, type B
Trigger Out	= BNC connector for trigger out signal
Ref In 10MHz	= BNC connector for incoming reference signal
Ref Out 10MHz	= BNC connector for outgoing reference signal
Gen1, Gen2	= BNC connectors for optional function generator output (option R&S MXO5-B6)
Trigger In	= BNC connector for external trigger input
1	= Kensington lock slot to secure the instrument against theft
2	= AC power supply connector and main power switch
3	= Exchangeable solid state disk (SSD, option R&S MXO5--B19)

USB Device

USB 3.1 gen1 interface of type B (device USB), to be used for remote control of the instrument.

Trigger Out

BNC output that can function as pass/fail output or trigger output.

Ref In 10 MHz

BNC input connector for 10 MHz reference frequency signals.

Ref Out 10 MHz

BNC output for 10 MHz frequency reference. Can be switched between internal and external reference.

See also: "Menu" > "Horizontal" > "Setup" tab > "Ref Clock"

Gen1, Gen2: Function generator

BNC output of the function generator, requires option R&S MXO5-B6.

Trigger In

The external trigger input is a BNC connector that is used to control the measurement by an external signal. The trigger level can be set from -5 V to 5 V.

For the external trigger input, the maximum input voltage is 400 V (V_p) and 300 V (RMS) at 1 M Ω input impedance.

Transient overvoltages on all input connectors must not exceed 400 V (V_p).

AC power supply connector and main power switch

The instrument supports a wide range power supply. It automatically adjusts to the correct range for the applied voltage. There is no line voltage selector.

The AC main power switch disconnects the instrument from the AC power line.

When you power up the instrument, be sure to comply with the warm-up phase specified in the data sheet before you start measurements.

3.2.4 Keys and controls

For an overview of the front panel keys, see [Chapter 3.2.1, "Front view"](#), on page 30.

3.2.4.1 Power key

The [Power] key is located on the lower left corner of the front panel. It starts up and shuts down the instrument's software.

The light of the key shows the instrument state, see [Chapter 3.1.9, "Switching on or off"](#), on page 29.

Remote command: `SYSTem:SHUTdown` on page 442.

3.2.4.2 Trigger controls

The keys and knob in the Trigger functional block adjust the trigger and start or stop acquisition.

**[Run / Stop]**

Starts and stops the continuous acquisition. The [Run / Stop] key lights green when the acquisition is running. When the acquisition is stopped, the key lights red.

[Single]

Starts a defined number of acquisitions. The [Single] key lights green when the acquisition is running. When the acquisition is stopped, the key lights red.

[Auto Norm]

Toggles the trigger mode between "Auto" and "Normal". The current setting is shown on the trigger label.

Auto The instrument triggers repeatedly after a time interval if the trigger conditions are not fulfilled. If a real trigger occurs, it takes precedence. The time interval depends on the time base.

Norm The instrument acquires a waveform only if a trigger occurs. The "Norm" LED lights up in green.

[Source]

Toggles the trigger source between the channels: C1...C8. The key lights up in the color of the selected channel.

[Slope]

Toggles the trigger slope or trigger polarity, dependent on the trigger type. The current setting is shown on the trigger label.

[Zone]

Opens a dialog to configure the zone trigger. A zone trigger combines the trigger condition with the intersection or non-intersection of one or more zones or masks.

3.2.4.3 Horizontal controls

The rotary knobs in the Horizontal functional block adjust the horizontal parameters. These settings are effective for all channel waveforms. In addition, a [Zoom] key is available.



[Position]

The rotary knob changes the horizontal position of the waveforms. Turn clockwise to move the waveforms to the right. To set the value to zero, press the knob. The current value is shown in the "Horizontal" label above the diagram.

The horizontal position defines the zero point of the diagram. It is the time distance to the reference point, which marks the rescaling center of the time scale.

[Scale]

The rotary knob adjusts the time scale for all signals. The time scale is also known as timebase.

Turn clockwise to stretch the waveforms. Doing so, the scale value *time/div* decreases. Press the knob to toggle between coarse and fine scale adjustment.

[Zoom]

Activates a zoom and supports the zoom setup.

If no zoom is on, the first press opens a zoom diagram for the active diagram. If at least one zoom is shown, the keypress opens the "Zoom" dialog. If only one zoom is defined, the next press closes the dialog and removes the zoom. If several zooms are defined and the dialog is open, the key toggles the zooms.

3.2.4.4 Vertical controls

The keys and knobs in the Vertical functional block select a signal and adjust the vertical scale and position of the selected signal.



Figure 3-4: Vertical controls of R&S MXO 5 with 4 input channels



Figure 3-5: Vertical controls of R&S MXO 5 with 8 input channels

[Position]

The vertical [Position] knob changes the vertical offset or the position of the selected waveform. The horizontal axis and the selected waveform are moved vertically. You can select whether the knob changes the offset or the position in the "Menu" > "Settings" > "Frontpanel" > "Knobs" dialog.

- Position indicates the vertical location in divisions.
- Offset moves the vertical center of the selected channel to the offset value.

If the selected waveform is a math or reference waveform, serial bus, or logic channel, the knob changes its vertical position.

The knob lights up in the color of the selected waveform. Turn clockwise to move up the waveform. To set the value to zero, press the knob.

The current offset value is shown in the channel icon.

Remote command:

[CHANnel<ch>:POSition](#) on page 466

[CHANnel<ch>:OFFSet](#) on page 465

[Scale]

Sets the vertical scale, which defines the displayed amplitude of the selected waveform.

The [Scale] knob lights up in the color of the selected waveform.

Turn the knob clockwise to stretch the waveform. Doing so, the scale value V/div decreases. Press the knob to toggle between fine and coarse adjustment. For analog waveforms, the scale value is shown in the signal icon.

To get the maximum resolution of the waveform amplitude, make sure that the waveforms cover most of the diagram's height.

Remote command:

[CHANnel<ch>:SCALE](#) on page 465

[CALCulate:MATH<m>:VERTical:SCALE\[:VALue\]](#) on page 528

[REFCurve<rc>:SCALE](#) on page 537

[Gen]

Available only for R&S MXO 5 with 4 input channels.

Opens the "Waveform Generator" dialog, if option R&S MXO5-B6 is installed.

The waveform generator can generate various function and arbitrary waveforms, sweeps, and parallel patterns. For detailed specifications, refer to the data sheet.

[Logic]

Available only for R&S MXO 5 with 4 input channels.

Opens the "Logic" dialog to configure and enable the logic buses L1 to L4. A logic bus (or parallel bus) has up to 16 logic (digital) channels. If logic buses are active, pressing the key toggles these buses.

The key lights up if at least one logic bus is enabled.

[Bus]

Available only for R&S MXO 5 with 4 input channels.

Opens and closes the "Protocol" tab in the "Apps" dialog, where you can select the required serial protocol and proceed to the protocol setup. The key lights up if the decoding of a serial bus is active.

[FFT]

Available only for R&S MXO 5 with 4 input channels.

Opens and closes the "Spectrum" dialog. The key lights up if a spectrum is active.

[Ref]

Opens the "Reference" dialog box, where you can configure and display reference waveforms. Press the key repeatedly to switch the reference waveform.

If a reference waveform is selected, the vertical rotary knobs are illuminated in white or light gray (default colors), depending on the selected waveform.

[Math]

Opens the "Math" dialog, where you can configure the calculation of mathematical waveforms using various mathematic operations on other waveforms. Press the key repeatedly to toggle the selected math waveform. If no math waveform is active, the key closes the dialog.

If a math waveform is selected, the vertical rotary knobs are illuminated in blue (default color).

3.2.4.5 Analysis keys

The controls in the bottom functional block have various functions.



[Multiuse]

The multiuse knob changes the element that is in focus. It lights up when a function is active on the knob.

[Intensity]

Adjusts the intensity of the waveforms on the screen.

[Cursor]

Starts a cursor measurement: sets vertical and horizontal cursors in the active diagram, and displays results of the cursor measurement. If cursors are already set, the keypress opens the "Cursor" dialog, where you can adjust the settings. The next keypress closes the dialog.

Cursors are markers which are placed at points of interest on a waveform. The instrument measures the cursor positions and delta values between parallel cursors.

[Measure]

Opens the "Measurement" dialog, where you can set up various measurements.

[History]

Activates the history and opens the history player. The next keypress closes the player. The history shows stored acquisitions that were acquired before the current one. The key is illuminated as long as the history is active.

[HD]

Activates the high definition mode and opens the "HD Mode" dialog box.

If the dialog is open, pressing the key closes the dialog. If the dialog is closed, the key disables the high definition mode. The key is illuminated as long as the HD mode is active.

[Touch Lock]

Locks the touchscreen to prevent unintended use. When the touchscreen is off, the key is illuminated. Press again to unlock the touchscreen.

Camera 

Saves a screenshot of the waveform display.

[Preset]

Resets the instrument to a predefined state and starts the continuous acquisition. All measurements, mask tests, zoom, and most individual settings are deleted, and all channels except for channel 1 are disabled. You can define preset configurations and save them to a file. The [Preset] key can be configured to set either factory defaults or a user-defined preset configuration.

[Autoset]

The instrument analyzes the enabled channel signals, and adjusts appropriate horizontal, vertical, and trigger settings to display stable waveforms.

In particular, the horizontal scale is set to a common value for all active channels, record length and sample rate are set to automatic detection. Vertical scale and offset are set for each channel individually. Probe settings, channel coupling and impedance remain unchanged. The trigger source is set to the signal with the lowest frequency, and the trigger type to positive edge. The trigger level is adjusted, and the trigger position is set to the reference point. Measurements, math and spectrum waveforms are kept. Undo and redo of an autoset is possible.

[Clear]



Deletes all measurement results including long-term measurement and statistics, all waveforms, and the history.

Apps 

Opens the "Apps" dialog, where you can start an application, serial protocol or another analysis function.

3.2.5 Checking the functionality

To check if the instrument works correctly, you can use the probe compensation signal and check the displayed signal.

1. Perform a self-alignment of the instrument:
 - a) Warm up the instrument. The minimum warm-up time is indicated in the data sheet.
 - b) Remove all probes from the input connectors.
 - c) Open the "Menu", and select "Settings" > "Maintenance" > "Alignment".
 - d) Tap "Start Alignment". Wait until the alignment has finished successfully.
2. Connect the probe's ground connector to the ground pin , and the tip to the square wave pin .
3. Press the [Preset] key.
4. Connect the probe to the input connector [C1].

The instrument recognizes the probe, and a signal is displayed in the diagram.
5. Tap the signal icon of C1 to open the vertical settings.
6. In the "Vertical" > "Setup" dialog, adjust the following:
 - "Vertical scale" = 600 mV/div
 - "Offset" = 900 mV

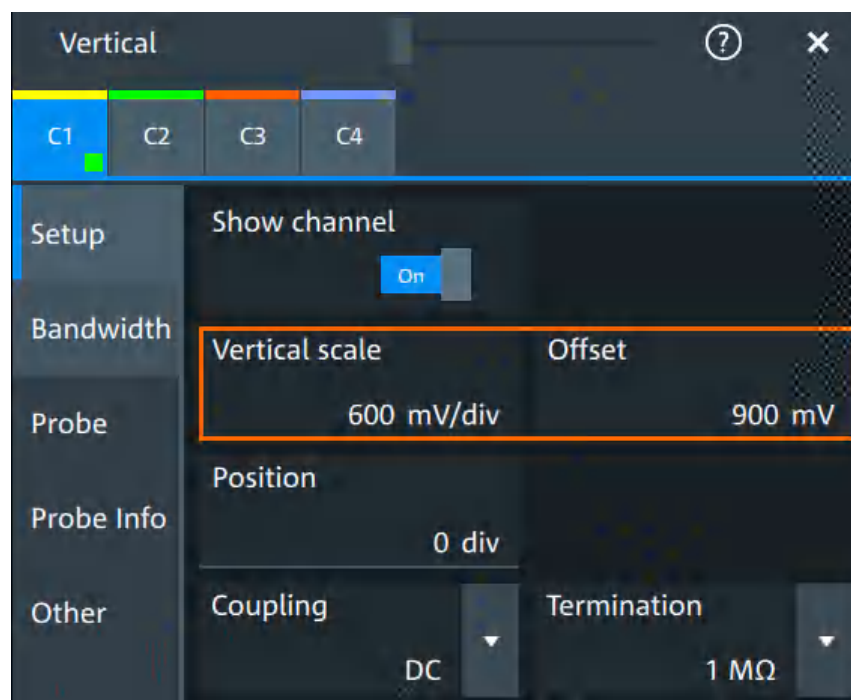

7. Turn the horizontal [Scale] knob to set the horizontal scale to 1 ms/div.
8. Press the [Source] key to set the trigger source to C1. The color of the key indicates the selected channel.
9. Turn the [Level] knob to set the trigger level to 300 mV.
10. Check the rectangle signal on the screen. The displayed signal should have an amplitude of about 3.3 V, which covers 5.5 divisions.

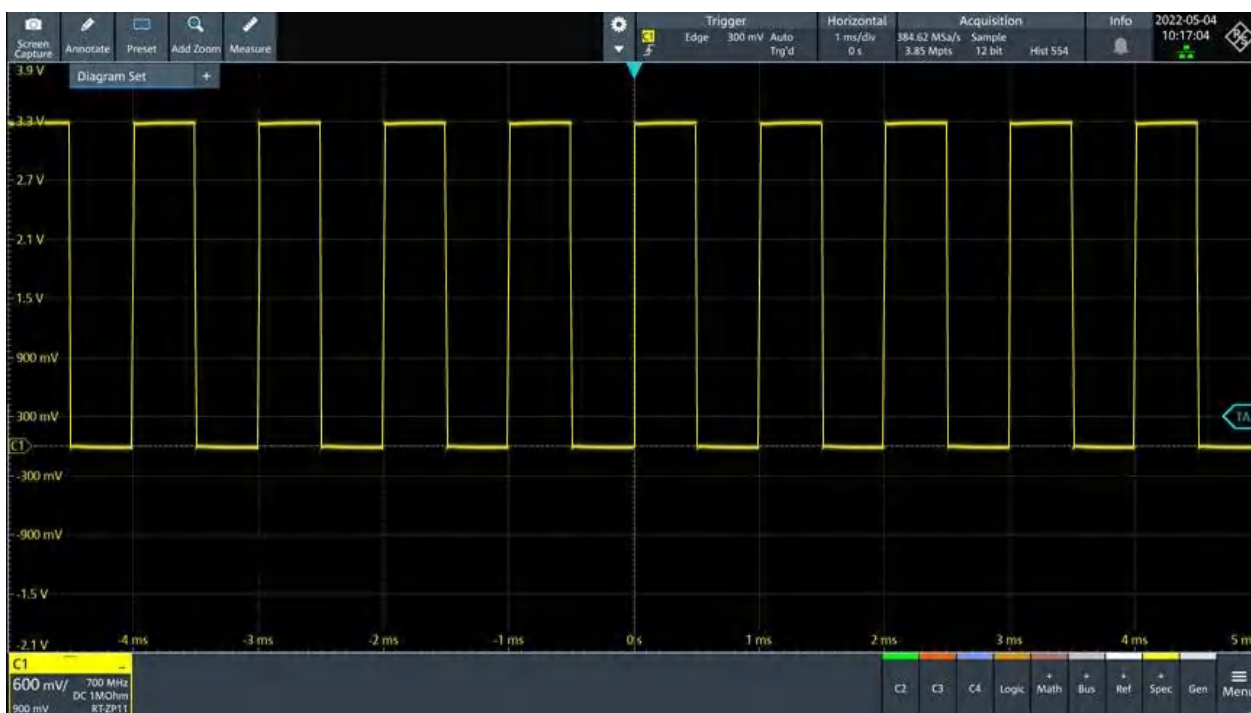

11. Repeat steps 4 to 10 for all other channels. Make sure to adjust the vertical settings for the connected channel, and also to set the trigger source to the connected channel.

4 Operating the instrument

There are three ways to operate the R&S MXO 5.

Manual operation

Use the touchscreen, keys and rotary knobs, or an optional mouse and/or keyboard. The principles of manual operation are explained in this section.

Remote control

Create programs to automatize repeating settings, tests, and measurements. The instrument is connected to a computer that runs the program.

This way of operation is described in: [Chapter 17, "Remote control commands"](#), on page 428.

Remote operation

For remote monitoring and operation of the instrument, a VNC server is installed on the R&S MXO 5. You need a LAN connection to the computer, and a VNC client or web browser to connect to the instrument.

For details, refer to [Chapter 16, "Network operation and remote control"](#), on page 407.

4.1 Means of manual interaction

The R&S MXO 5 provides the following means of manual interaction, which you can use alternatively or complementary:

- **Touchscreen:**
Using the touchscreen allows for direct interaction with the instrument. Use your finger to place waveforms on the screen, mark areas for zoom, set parameters in dialogs, enter data, and much more. The control elements and actions on the screen are based on common concepts, and you easily become familiar with the user interface.
Tapping the screen works like clicking mouse buttons:
 - Tap = click: Selects a waveform or parameter, or provokes an action.
 - Double-tap = double-click: Has the same effect as touch and hold, it opens the on-screen keyboard or keypad, or a specific editor if available.
- **Function keys and rotary knobs:**
The front panel provides frequently used functions and controls to operate the instrument. Use knobs to set levels and scales, and keys to initiate actions and to open dialogs.
- **Optional mouse and/or keyboard**
These devices work in the normal manner.

4.2 Touchscreen display

4.2.1 Information on the display

The GUI of the instrument shows the waveforms and measurement results, and also information and everything that you need to control the instrument. All waveform-related GUI elements are shown in [Figure 4-1](#). An overview of control elements - like dialog box, toolbar - is given in [Chapter 4.2.2, "Control elements on the GUI"](#), on page 49.



Figure 4-1: Information in the graphical user interface

- 1 = Diagram
- 2 = Layout
- 3 = Trigger position
- 4 = Toolbar
- 5 = Grid
- 6 = Trigger, horizontal and acquisition label
- 7 = Info
- 8 = Trigger level
- 9 = Menu
- 10 = Signal bar with signal activators (10a), and active waveforms (10b)
- 11 = Channel markers indicate the ground levels

Diagram

A diagram shows one or more waveforms: analog and digital channels, reference and math waveforms, track, and serial buses. Zoom details, spectrum and other special waveforms are shown in separate diagrams. One diagram can hold up to 16 analog waveforms, i.e. analog channels, reference and math waveforms, and tracks.

To arrange the diagrams on the screen, the Rohde & Schwarz SmartGrid function helps you to find the target place simply and quickly. For details, see [Chapter 4.5, "Rohde & Schwarz SmartGrid"](#), on page 54. You can also adjust the diagram size by dragging the diagram border.

Layout

A layout shows a set of diagrams and result tables. You can configure up to four layouts using the SmartGrid functionality. For details, see [Chapter 4.5, "Rohde & Schwarz SmartGrid"](#), on page 54.

Grid

The grid shows the vertical and horizontal divisions. The division lines are labeled with the correspondent values. The grid labels have the color of the waveform to which they belong. If several waveforms are shown in one diagram, the grid has the color of the selected waveform.

Trigger position and trigger level

The blue markers show the horizontal position of the trigger and the vertical trigger level. You can touch and move the trigger markers in the diagram to set the positions. The trigger point is the zero point of the diagram.

The trigger position can be moved outside the diagram.

Trigger

The "Trigger" label shows the main trigger settings. If you tap the label, the corresponding dialog box opens.

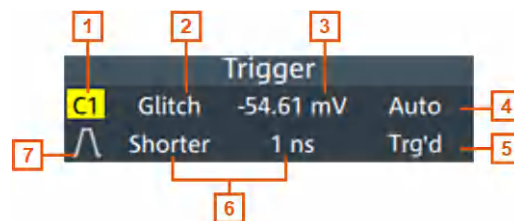

Figure 4-2: Trigger label

- 1 = Trigger source
- 2 = Trigger type
- 3 = Trigger level
- 4 = Trigger mode
- 5 = Trigger state
- 6 = Trigger type specific settings
- 7 = Trigger slope

See also: [Chapter 7.1.1, "Trigger information"](#), on page 135.

Horizontal

The "Horizontal" label shows the main timebase settings. If you tap the label, the corresponding dialog box opens.

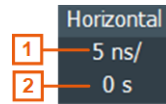

Figure 4-3: Horizontal label

- 1 = Time scale
- 2 = Horizontal position

Acquisition

The "Acquisition" label shows the main acquisition settings, and the progress of long acquisitions. If you tap the label, the corresponding dialog box opens.

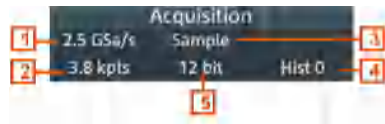

Figure 4-4: Acquisition label

- 1 = Sample rate
- 2 = Record length
- 3 = Acquisition mode
- 4 = Number of acquired waveforms
- 5 = Resolution

See also: ["Progress information"](#) on page 66.

Info

The "Info" button on the toolbar points to the status messages of the instrument. To open the message box, tap the button. See also: [Chapter 4.11, "Information and notifications"](#), on page 65.

Signal bar

The signal bar is the control center for all waveforms. All enabled waveforms are shown on the left side of the signal bar. On the right side of the signal bar, you see the signal activators of inactive waveforms. Tap a signal activator to enable the waveform.

Each waveform is represented by a signal icon. If the waveform is shown in a diagram, the signal icon displays its main vertical and probe settings. If you tap a signal icon, the dialog with vertical settings for this waveform opens. If you tap the "Minimize" icon on the signal icon, the waveform switches from the diagram area to the signal icon: the icon is grayed out. See [Chapter 4.4, "Working with waveforms"](#), on page 52 for a detailed description.

In [Figure 4-1](#), the signal icons C1, C2 and C3 show the main settings, and the waveforms are displayed in diagrams.



Figure 4-5: Signal label

- 1 = Vertical scale
- 2 = Offset
- 3 = Bandwidth
- 4 = Coupling and termination

If many waveforms are active, then waveforms of the same type are grouped in one signal icon. Tap the group icon to open the individual signal icons.

4.2.2 Control elements on the GUI

The GUI provides everything that you need to control the instrument, to analyze waveforms, and to get measurement results. Figure 4-6 shows the control elements at a glance.



Figure 4-6: Control elements on the graphical user interface

- 1 = Toolbar
- 2 = Tab in a dialog box
- 3 = Dialog box
- 4 = Result table
- 5 = Signal bar
- 6 = Menu

Toolbar (1)

The icons on the toolbar provide quick and easy access to the most important functionality. For a detailed description, refer to [Chapter 4.6, "Toolbar"](#), on page 56.

If you adjust the settings of an analyzing function, e.g., cursor measurement, the overlay menu is shown instead of the icons. The overlay menu provides the most important settings of the current action. If you need more settings, "Setup" opens the corresponding dialog box.

Dialog box (2, 3)

The tabs of the dialog boxes contain all task-oriented settings and operations, and buttons for calling related tabs. The usage of dialog boxes is described in [Chapter 4.7, "Using dialog boxes"](#), on page 59.

Result table (4)

If you perform cursor or automatic measurements, the result table shows the results of the action below the diagrams. You can move the result tables to the left or right of the diagrams.

See also: [Chapter 4.9, "Displaying results"](#), on page 62.

Signal bar (5)

The signal bar summarizes all waveforms as described in ["Signal bar"](#) on page 48.

Menu (6)

The menu provides access to the complete functionality of the R&S MXO 5.

At the top of the menu, you can find a search box for a quick access to any parameter you need. A list of all found results is shown on the left side of the menu. Tap the result entry and the dialog containing this parameter opens.

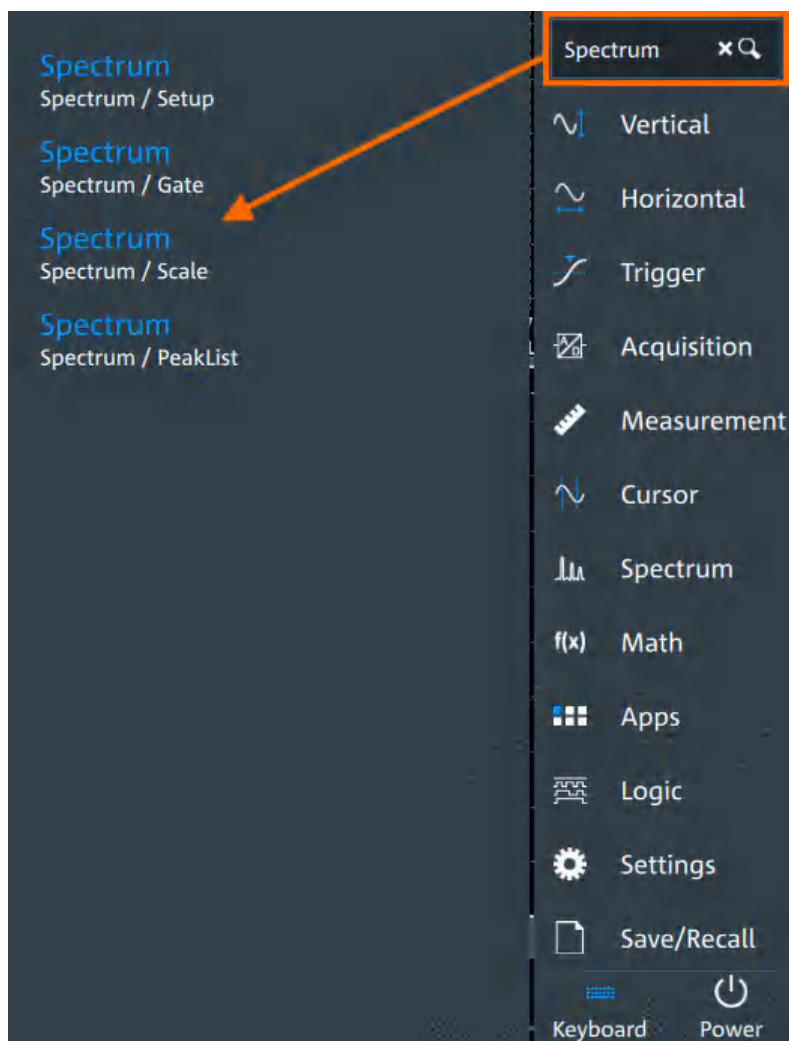

4.3 Applications

The "Apps" dialog provides fast access to all available applications, for example, to serial protocols, frequency response analysis or file browser.

- ▶ To open the "Apps" dialog:
 - Open "Menu" > "Apps".
 - Press the  [Apps] key on the front panel.

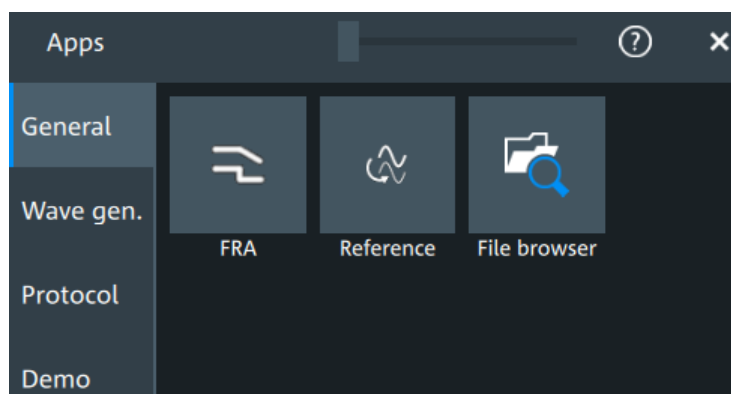

4.4 Working with waveforms

The R&S MXO 5 can create and display many waveform types. The most important are:

- Channel waveforms:
For each input channel, one channel waveform is shown.
- Reference waveforms:
Four waveforms can be used as reference for comparison and analysis.
- Math waveforms:
Five mathematic waveforms can be created with mathematic operations performed on channel, reference, and other math waveforms.
- Zoom waveforms:
Show the details of waveforms.
- Digital waveforms:
The Mixed Signal Option R&S MXO5-B1 provides 16 digital channels grouped in two logic probes (pods) with 8 channels each.

Waveform handling

The R&S MXO 5 can show and analyze many waveforms. To handle this multitude while keeping track of it, the R&S MXO 5 provides intelligent support:

- The color system helps to distinguish the waveforms. The color of the vertical rotary knobs indicates the signal that is focused (selected). The color of each waveform can be changed, the color of its signal icon and of the illuminated keys is adjusted to the new color. Alternatively, a color table can be assigned to a waveform.
Settings: "Menu" > "Settings" > "Appearance" > "Colors" tab.
- You can arrange the waveforms in one diagram, or in separate diagrams. The Rohde & Schwarz SmartGrid function helps to arrange the waveforms.
See also: "[Diagram](#)" on page 47.

Waveform states

Depending on its place on the screen and the effect of settings, a waveform has one of the following states:

- Off
- Active:
The waveform is shown in a diagram
- Selected:
One of the active waveforms that has the focus. In each diagram, one of the assigned waveforms is selected – it appears "on top" in the diagram, and the grid labels have the color of the selected waveform.
The vertical [Position] and the [Scale] knobs are illuminated with the color of the selected waveform.
- Minimized:
The waveform signal icon is greyed out, and the waveform is removed from the diagram.

To switch a waveform on

A channel waveform is activated when you connect the probe. You can switch it on and off according to your needs.

- ▶ Choose one of the following ways:
 - Press the channel key.
 - In the "Vertical" dialog box, select the channel. Tap "Show channel" > "On".The waveform is now active, selected, and is shown in the diagram.

Remote command: [CHANnel<ch>:STATe](#) on page 464

To select a waveform

- ▶ Choose one of the following ways:
 - Tap the waveform in the waveform diagram.
 - Tap the signal icon.
 - To select a channel, reference, or math waveform, press the corresponding key.

Note: Zoom waveforms in zoom diagrams cannot be selected.

To minimize a waveform

- ▶ Tap the "Minimize" icon in the upper right corner of the waveform's signal icon in the signal bar.

The waveform disappears from the diagram and the signal icon turns lighter gray.

To arrange a waveform using the SmartGrid

See [Chapter 4.5, "Rohde & Schwarz SmartGrid"](#), on page 54.

To switch off a waveform

- ▶ Do one of the following:
 - Tap the "Delete" icon in the toolbar, and then signal icon of the waveform. You can also tap the waveform directly. If several waveforms overlap or lie close together, a selection list is shown.
 - To switch off a minimized waveform, tap the "Close" icon in the upper right corner of the signal icon.
 - If the waveform is an input channel:
 - Disable "Show channel" in the "Vertical" > "Setup" tab.
 - Select the channel. Then press its channel key twice.

Remote command: `CHANnel<ch>:STATe` on page 464

4.5 Rohde & Schwarz SmartGrid

The Rohde & Schwarz SmartGrid helps to create and arrange the diagrams on the screen with drag&drop. The diagram layout depends on the position where you drop the signal icon, in relation to an existing diagram.

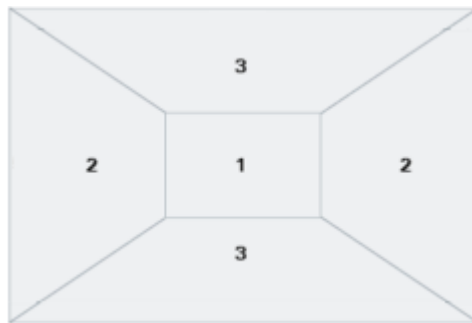

Figure 4-7: SmartGrid positions

- 1 = In the existing diagram, overlay of signal
- 2 = New diagram on the left or right
- 3 = New diagram above or below

The diagram configuration is deleted when you use [Preset] or *RST.

Working with layouts

A SmartGrid configuration of one or more diagrams is called "tab" or "layout". You can define several layouts and switch between them.

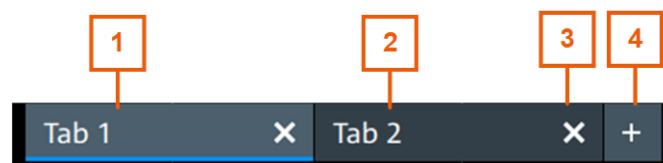

- 1 = Tab 1 (layout 1, blue underline indicates that the set is currently displayed)
- 2 = Tab 2 (layout 2)
- 3 = Tap to remove a layout
- 4 = Tap to add a layout

You can add up to four layouts at the upper left corner of the screen:

1. Tap on the **+** icon next to the layout.
A new layout is created.
2. To change the layout name, touch and hold the tab name. The on-screen keyboard opens to enter the new name. Names must be unique.
3. To remove the layout, tap on the **×** next to the layouts title.

To arrange a waveform using the SmartGrid

1. Select the layout that you want to rearrange.
2. Drag the signal icon to the diagram area, and move it around.
The Rohde & Schwarz SmartGrid appears and a blue or highlighted area shows where the waveform will be placed.



3. Drop the waveform in the target area.
The waveform appears in an existing or in a new diagram, and it is selected for further actions.
4. To change the size of a diagram, touch the border between two diagram frames and drag it to the required position.
5. If a diagram is empty, you see a trash can icon in the diagram center. Use the icon to delete the diagram, or drag waveform icons into the diagram.

Remote commands: see [Chapter 17.7.2, "SmartGrid"](#), on page 443

4.6 Toolbar

The toolbar provides direct access to important control and measurement functions.

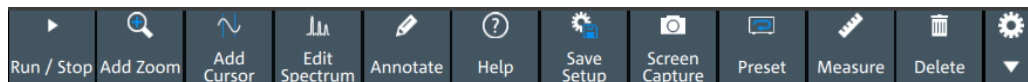

By default, the toolbar shows the most frequently used functions. You can configure the content of the toolbar, see [Chapter 4.6.2, "Configuring the toolbar"](#), on page 56.

4.6.1 Using the toolbar

Using the toolbar is easy and straightforward.

Some of the toolbar functions are one-click actions. These actions are performed immediately when you tap the icon.

Other toolbar functions are analyzing functions. These actions are interactive actions.

To use analyzing functions (interactive actions)

1. Tap the icon of the function in the toolbar.
2. Check and adjust the settings in the overlay menu.
3. Select the source waveform if needed. For zoom, drag a rectangle, or tap the diagram to define the zoom area.
4. If the overlay menu does not close automatically, tap the  icon.

4.6.2 Configuring the toolbar

You can configure the content of the toolbar so that only the required functions are displayed. The toolbar configuration is part of the user preferences. It is retained when you switch off and on the instrument, and you can save it in the user preferences and user-defined preset.

1. To open the toolbar configuration, tap the icon in the toolbar:



2. Select the required toolbar functions:
 - a) In the "Show/Hide tools" section, disable all functions that you do not need.
 - b) In the "Show/Hide tools" section, enable the functions that you want to add to the toolbar.
 - c) In the "Drag to rearrange tools" section, move the icons to arrange them as required.
3. To empty the toolbar, select "Deslect all".

- To get the factory configuration of the toolbar, select "Restore default".

A detailed description of the toolbar functions is given in [Chapter 4.6.3, "Toolbar functions"](#), on page 57.

Remote commands:

- `DISPlay:TOOLbar:COUNT?` on page 449
- `DISPlay:TOOLbar:DESelect` on page 449
- `DISPlay:TOOLbar:RESTore` on page 449

4.6.3 Toolbar functions

This section describes all toolbar functions in detail.

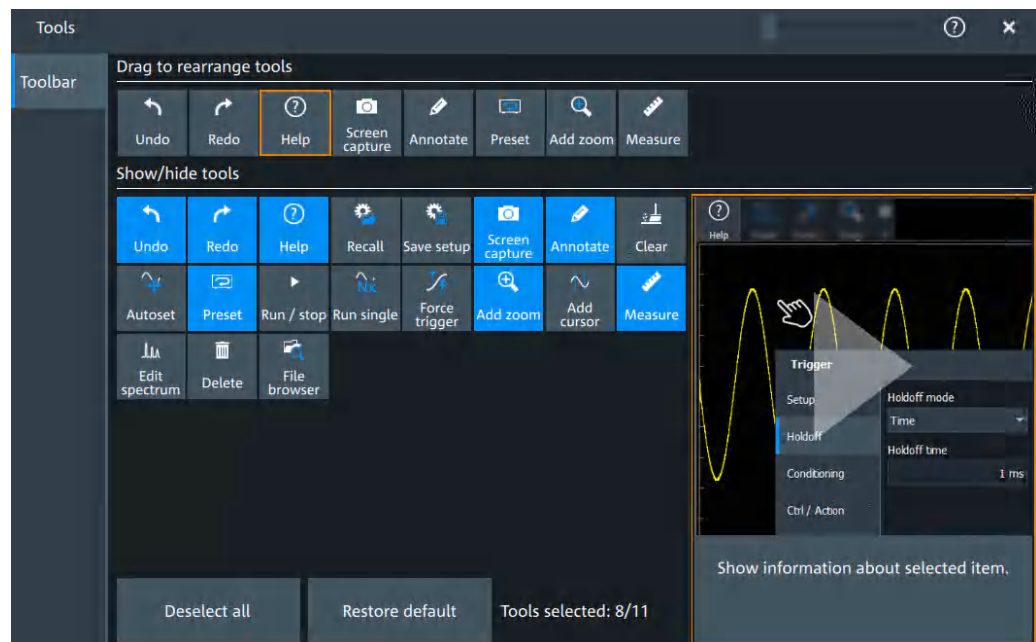

You can configure the content of the toolbar, see [Chapter 4.6.2, "Configuring the toolbar"](#), on page 56.

The following list describes at first the default toolbar functions and then the additional functions.



Undo

Undoes the last setting actions step by step. Some actions cannot be revoked: locking the touchscreen with [Touch Lock], and saving data.



Redo

Recovers the undo steps in reverse order.

**Help**

Enables the context help display. The help window opens when you tap a parameter.

See also: ["To display the context help"](#) on page 67.

**Recall**

Opens a window to select and load instrument settings that were previously stored in a saveset.

**Save setup**

Saves the current instrument settings in a saveset.

You can reload the saveset using the "Recall" toolbar icon, or using "Menu" > "Save/Recall" > "Recall" tab > "Saveset".

The filename is created according to the autonaming pattern, defined in "Menu" > "Settings" > "Save / Recall" > "Autonaming" tab.

**Screen capture**

Saves a screenshot of the current display using the settings defined in "Menu" > "Save/Recall" > "Save" tab > "Screenshot".

**Annotate**

Displays drawing tools for marking areas on the diagram, and for adding text. You can also select the color.

See also: [Chapter 4.10, "Adding annotations"](#), on page 63.

**Clear**

Deletes all measurement results including all waveforms and statistics.

Remote command:

[DISPlay:CLR](#) on page 456

**Autoset and Preset**

Performs an autoset, or a preset to a default state. The icons have the same functionality as the corresponding keys on the front panel. They are useful when you operate the instrument remotely.

**Run / stop and Run single**

Starts and stops the continuous acquisition, or starts a defined number of acquisition cycles. The icons have the same functionality as the corresponding keys on the front panel. They are useful when you operate the instrument remotely.

**Force trigger**

Starts an immediate single acquisition. If the acquisition is running in normal mode and no valid trigger occurs, use "Force trigger" to confirm that a signal is available. Then you can use the displayed waveform to determine how to trigger on it.

**Add zoom**

Adds a zoom diagram, an area of the acquired waveform which is visually enlarged. Click a diagram to create a zoom or draw a rectangle to define the range of the zoom.

**Add cursor**

Adds a cursor set. Select the cursor type and the source to be measured.

See also: [Chapter 9.1, "Cursor measurements"](#), on page 184.

**Measure**

Adds one or more measurements to the waveform.

Tap the icon, and select the category and the measurements in the overlay menu. Select the waveform to be measured, and close the overlay menu.

**Edit spectrum**

Edit the existing spectrum settings in the overlay menu.

**Delete**

Removes waveforms, diagrams and zooms from the display.

Tap the "Delete" icon. A recycle bin icon marks all objects that can be deleted. Tap this icon to remove an object. Tap the "Delete" icon again to disable the function.

**File browser**

Opens the file browser dialog.

See also: [Chapter 12.5, "File browser dialog"](#), on page 283.

4.7 Using dialog boxes

All functionality is provided in dialog boxes as known from computer programs. You can control the instrument intuitively with the touchscreen. This section provides an overview of the accessing methods and describes how to use the dialog boxes.

Each dialog box has three icons in the upper right corner:

	Closes the dialog box
	Opens the help window for the dialog
	Shift sideways to change the transparency of the dialog box



For direct access to important control and measurement functions, use the toolbar, see [Chapter 4.6, "Toolbar"](#), on page 56.

To open a dialog box

- ▶ Perform one of the following actions:
 - Open the "Menu", and select the menu entry.
 - Press the function key on the front panel.

- Double-tap a result icon, or tap the  icon in a result box to open the corresponding dialog box.
- To open the "Vertical" dialog box of a waveform, tap the signal icon.
- Tap the "Horizontal", "Acquisition" or "Trigger" label to open the corresponding dialog box.

To close a dialog box

- ▶ Tap the "Close" icon in the upper right corner.

4.8 Entering data

To set parameter values and enter other data, you use the various knobs and the on-screen keypad or keyboard.

Using scale, position and level knobs

The instrument has dedicated rotary knobs to set vertical and horizontal positions and scale, and the trigger level.

1. Turn the knob to change the value.
2. Press the knob:
 - [Scale]: to toggle the increment.
 - [Position]: to set to zero.
 - [Level]: to set the trigger level to 50% of the signal.

To enter values with the on-screen keypad

For data input in dialog boxes, the touchscreen provides an on-screen keypad to enter numeric values and units. For text input, the on-screen keyboard with English key layout is used.

1. Double-tap the entry field. The on-screen keypad opens.



2. Enter the numeric value using the following methods:

- To use the default value, tap "Reset" (if available).
- To get the value that was used before the keypad was displayed, tap "CE".
- To use the minimum or maximum value, tap "Min" or "Max", respectively.
- To increase the displayed value in fixed steps, tap "Inc".
To decrease the value in fixed steps, tap "Dec".
- To enter a user-defined value, tap the numbers and complete the entry by tapping the unit button.
 - "±" changes the sign of the value.
- To calculate a value, tap the calculator  to display the arithmetic operators. Use the displayed fields to calculate your values.

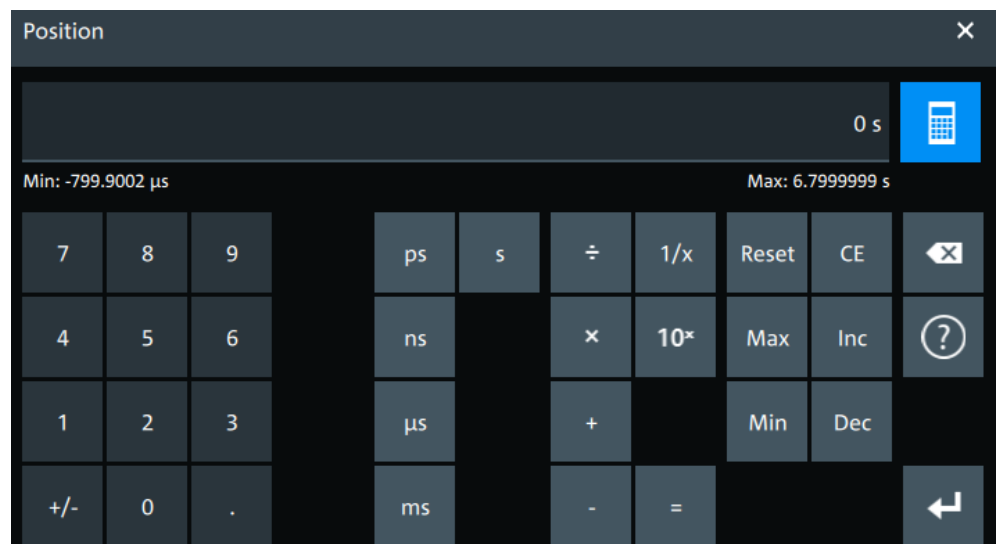

3. Tap  to complete the entry.

To enable the on-screen keyboard

1. Tap "Menu".
2. Tap on "Keyboard" to enable the on-screen keyboard.

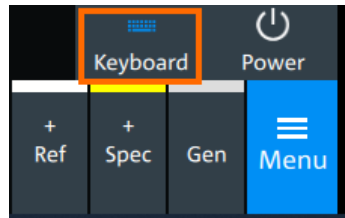

If the on-screen keyboard is enabled, the keyboard icon is colored blue. If it is disabled, the color is white.

To enter data with the on-screen keyboard

1. Double-tap the entry field to open the on-screen keyboard.

Report|



2. Enter the text as you would on a normal keyboard.
 - To change the language, tap . The current language is shown on the blank key.
 - To display numbers and signs, tap .
3. Tap to complete the entry or to minimize the keyboard.

4.9 Displaying results

The results of measurements, protocol decoding and others are displayed immediately. The font size can be adjusted.

To arrange the results on the display

1. Touch and hold the "....." field on top of the results table.

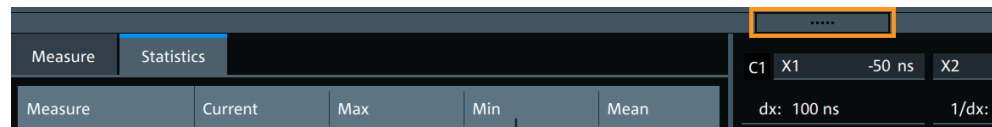

2. Drag on the screen. The SmartGrid indicates where the result table can be placed. Drop the box on one of the buttons. The results are shown at the left the right, or below the diagrams.

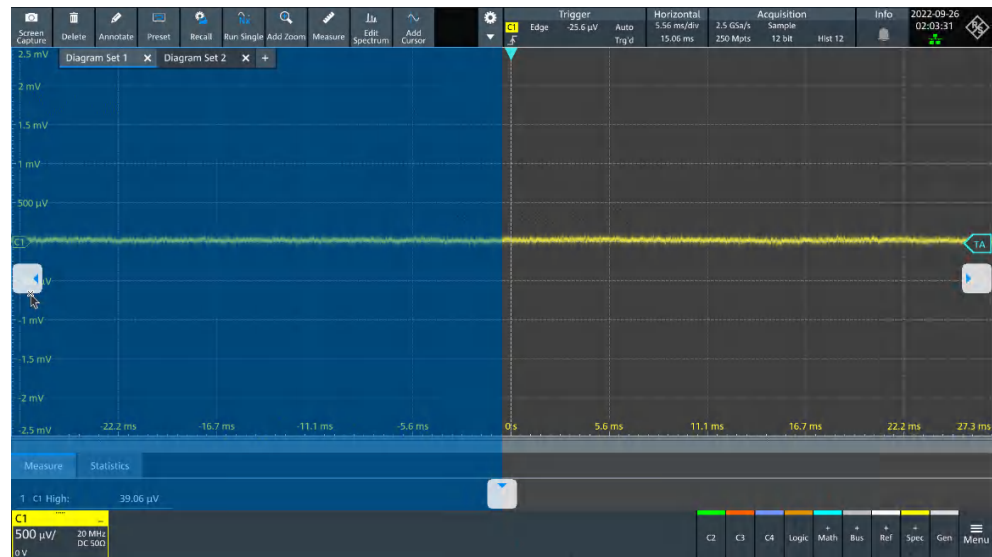

To open the corresponding settings

- ▶ Double-tap one of the result values.
The corresponding dialog opens.

To adjust the font size of results

1. Open the "Menu" > "Settings" > "Appearance" dialog.
2. Select the "Dialogs" tab.
3. Set the "Result dialog" > "Font size".

4.10 Adding annotations

The R&S MXO 5 provides an easy way to add annotations to the screen. With the toolbar "Annotate" you can add text, forms or even draw.

To add an annotation

1. On the toolbar, tap on the "Annotate" icon.

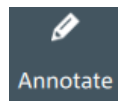

The annotation overlay menu opens.

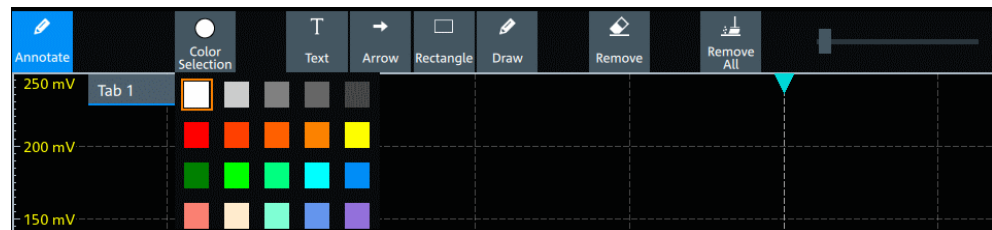

2. Tap "Color selections" and select the color that you want to use for your annotations.
3. Add one or more of the following:
 - One of the predefined forms: "Arrow" or "Rectangle"
 - "Text": adds a text element to the screen and opens on-screen keyboard. You can change the text later, by tapping on an existing annotation and typing in the new text.
 - "Draw": you can draw any form on the screen.



4. To move one of the annotations, tap on it and drag it to the required position.

To remove an annotation

1. In the "Annotate" overlay menu, tap on "Remove".
2. Tap on any existing "Arrow", "Rectangle" or "Text" annotation to remove it.
3. The "Remove" function, acts as an eraser on drawings: it enables you to erase only certain parts of your drawing. Drag your finger over any part of your drawing to erase it.

4. To remove all annotations from the screen, tap on "Remove All".

4.11 Information and notifications

The oscilloscope provides various information:

- Instrument information, e.g. connection status, firmware version
- Notifications, e.g. status messages
- Progress information, e.g. for long acquisitions, data saving

Instrument information

In the upper right corner of the screen, you see the Rohde & Schwarz logo, date and time, the symbolic information on LAN connection and the notifications status.

- ▶ To see the instrument information, select the Rohde & Schwarz logo.

You can find information about the instrument model, bandwidth, network settings, firmware version and operating time.

- ▶ To hide the date and time or change the display format, select the date/time display.

Notifications

Notifications are status messages, information on mismatching settings and similar information. They are displayed for a few seconds and saved.

The color of the dot before the text indicates the severity: gray for information, orange for warnings, and red for errors.

- ▶ To read the notifications, select "Notification".

You can save or delete the list of notifications.

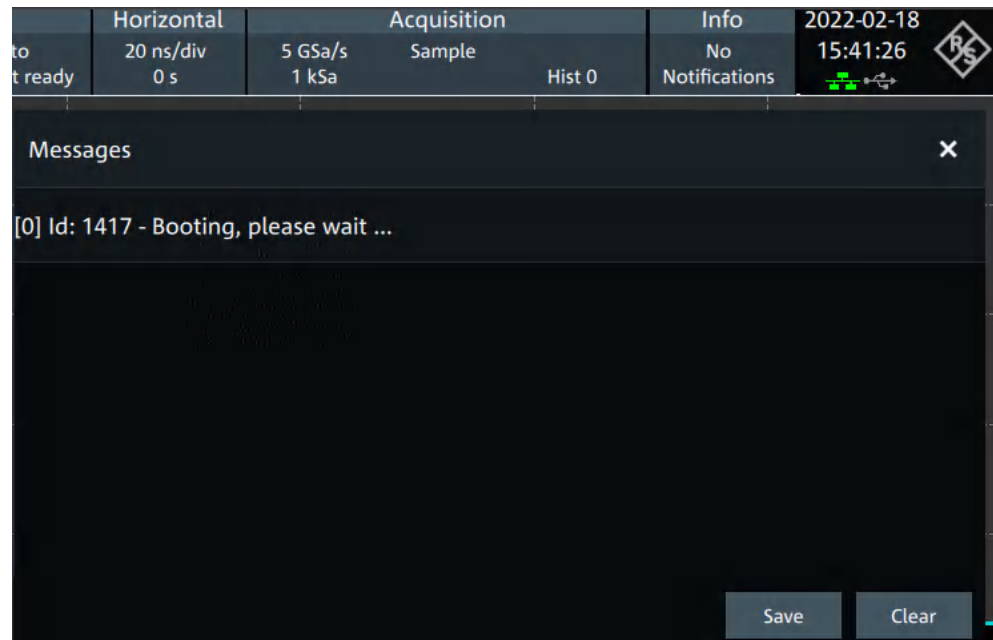

Progress information

If an acquisition, operation or process takes more time until results are displayed, a progress bar or symbol indicates that a process is running.

The progress of saving operations and update or creation of a reference waveform is shown in a progress bar. You can cancel the process. A notification informs about the result.

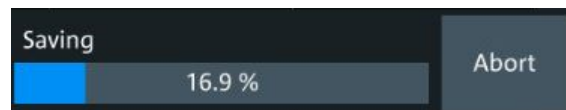

Figure 4-8: Progress bar for saving waveform data

The progress of running acquisitions is shown in the acquisition label. A circle indicates the state of the current, incomplete acquisition. Progress in roll mode, average mode and single acquisition with $N > 1$ is indicated by a progress bar and counter.



Figure 4-9: Progress of incomplete long acquisition in average mode, Run Single = 5, first acquisition is finished

4.12 Getting user assistance

If you need information on the instrument's functionality, you can use the instrument help. It provides contextual information on a setting or dialog. If the help window is open, you can browse and search for further information using links, table of contents, and search.

4.12.1 Displaying help

To display the context help

1. Enable the "Help" icon on the toolbar.

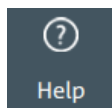

2. Tap the parameter for which you need information.

The "Help" window opens and displays the comprehensive description and the corresponding remote command. You can browse the help for further information.

To open a dialog help

1. Open a dialog.
2. Tap the ⓘ "Help" icon in the dialog header.
3. Tap a subtab or menu item.

The help window opens with the dialog help page, where you can select the topics.

4.12.2 Using help

You can find a specific information and navigate the contents by following means:

- Table of contents
- Buttons in the help window title:



- "Home": Go to the start page
- "Back", "Forward": Browse the pages that you visited before
- Search with filter:

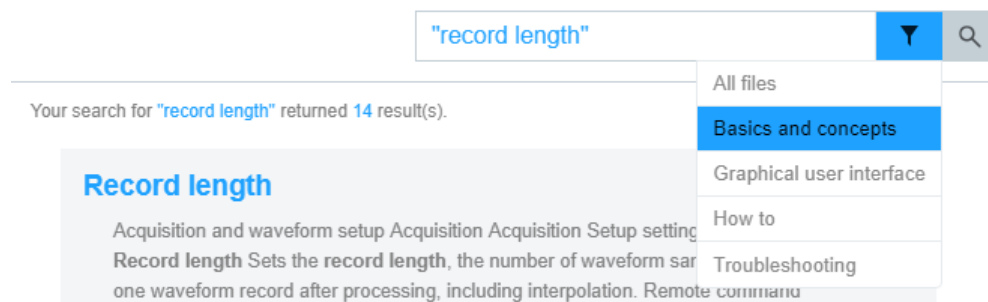

- Enter the word to be found, or a phrase in quotes.
- Tap the filter icon and select the information type.

5 Instrument setup

Access: "Menu" > "Settings".

In the "Settings" dialog, you can adapt various instrument settings to your requirements, such as language, display appearance, and assign functions to some keys.

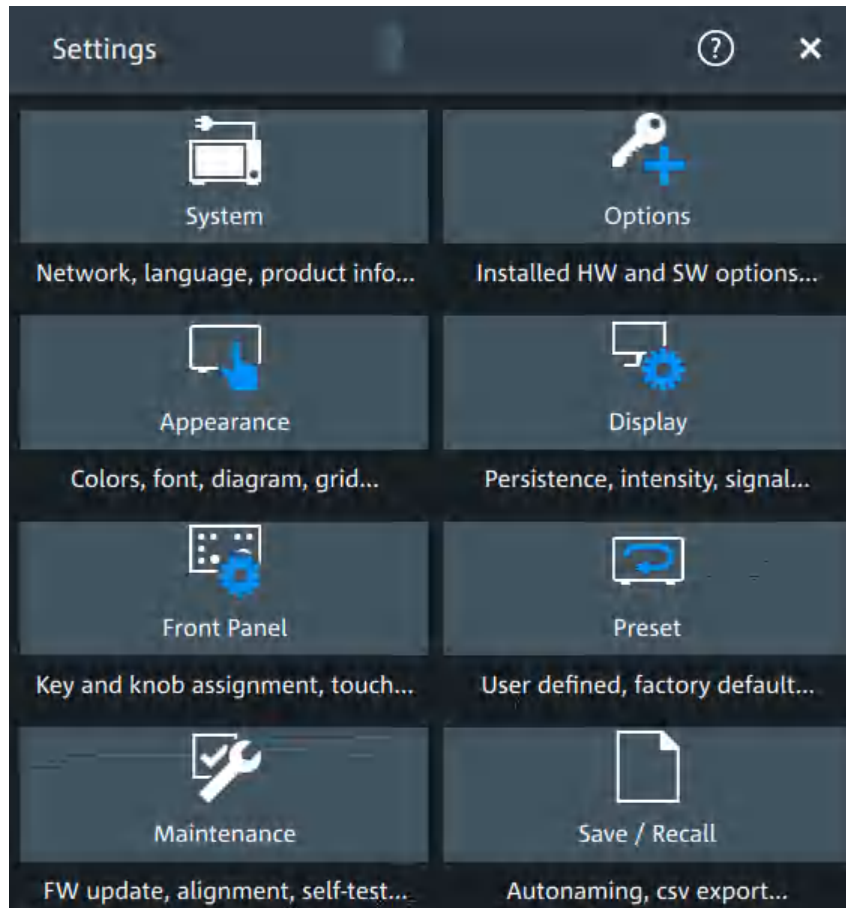

The following settings and procedures are described in the current section:

• System settings	70
• Option settings	76
• Appearance settings	78
• Display settings	84
• Front panel settings	87
• Preset setup	88
• Maintenance settings	91
• Save / recall	95

5.1 System settings

In the "Settings" > "System" dialog box, you find all instrument, firmware and network-related information. Here you can also set the language that is used in the dialogs.

5.1.1 About settings

Access: "Menu" > "Settings" > "System" > "About".

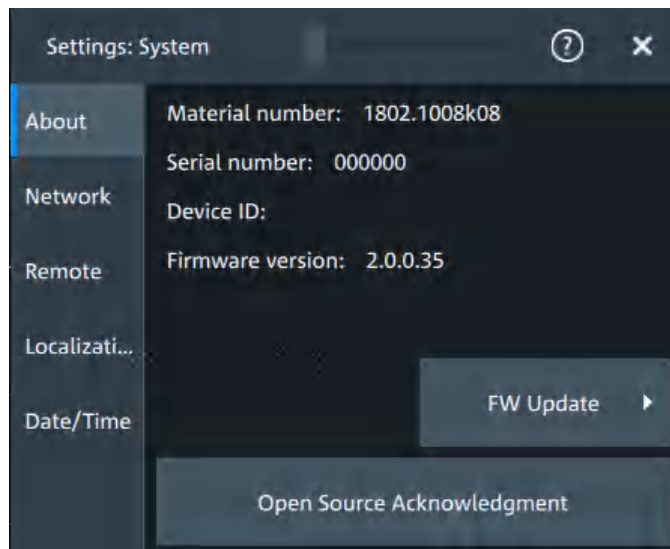

Instrument

Displays general information about the instrument, including:

- "Material number"
- "Serial number"
- "Device ID"
- "Firmware version"

Remote command:

[*IDN?](#) on page 436

FW update

Opens the "FW update" dialog box. See [Chapter 5.7.1, "Firmware update"](#), on page 91.

Open source acknowledgment

Displays the "Open Source Acknowledgment" document.

5.1.2 Network settings

Access: "Menu" > "Settings" > "System" > "Network".

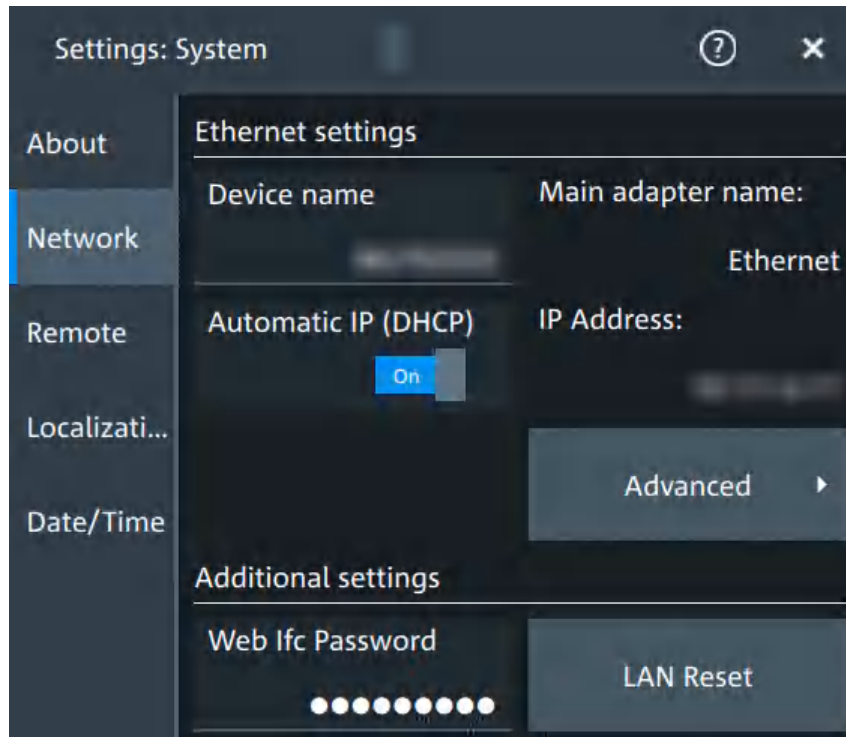

Ensure that you do not use the IP address range 192.168.0.x to avoid internal address conflict.

Setting up a manual IP address within this range is rejected by the firmware. If the automatic DHCP server assigns an IP address within this range, the instrument is not reachable from this network.

An error message is displayed, if the firmware detects an IP address error:

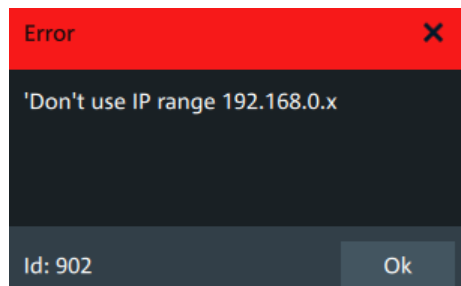

Device name

Indicates the currently defined device name. This value is required to configure the instrument for work in a network.

NOTICE! Risk of network problems. Incorrect configuration of the device name can create network problems. Consult your network administrator before changing the name.

Remote command:

`SYSTEM:COMMunicate:NET[:HOSTname]` on page 441

Automatic IP (DHCP)

If enabled, the IP address of the oscilloscope is obtained automatically.

IP address

Shows the current IP address of the instrument. If "Automatic IP (DHCP)" is "Off", you can change the IP address here. For complete manual configuration, select "Advanced". See also: [Chapter 16.1, "Connecting the instrument to the network \(LAN\)"](#), on page 407.

Web Ifc Password

Password for LAN configuration. The default password is *LxiWebIfc*.

LAN reset

Resets the LAN configuration to its default settings using the network configuration reset mechanism (LCI) for the instrument.

The LAN settings are configured in the "Advanced" dialog, or using the instrument's web browser (see [Chapter 16.2, "Web interface"](#), on page 410).

Advanced

Opens a dialog box to configure the network connection.



You need these settings to configure the LAN connection manually, without DHCP.

NOTICE! Connection errors can affect the entire network. You must assign valid address information before connecting the instrument to the LAN. Contact your network administrator to obtain a valid IP address and other connection data.

See also: [Chapter 16.1, "Connecting the instrument to the network \(LAN\)"](#), on page 407.

5.1.3 Remote settings

Access: "Menu" > "Settings" > "System" > "Remote".

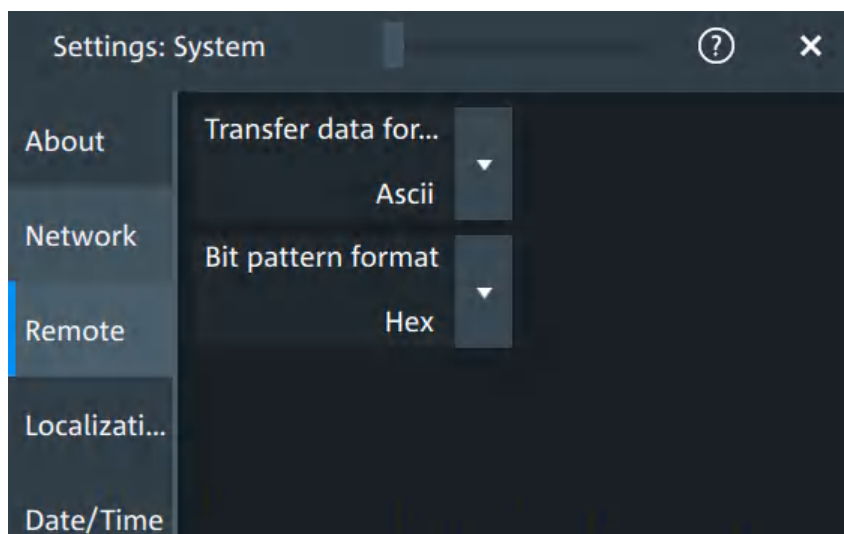

The following settings are required for remote control of the instrument via a connected computer.

Transfer data format

Selects the data format that is used for transmission of waveform data from the instrument to the controlling computer.

Waveform data can be retrieved using the following commands:

- `DIGital<m>:DATA[:VALues]?`

"Ascii" Data values are returned in ASCII format as a list of comma-separated values in floating point format.

"FLOAT" Binary format. Up to 7 significant digits are stored. If there are more than 7 digits, the number is rounded off.

"DOUBLE" Binary format. Up to 15 significant digits of the numbers are stored.

"INT8/16/32" Signed integer data with length 8/16/ 32 bit.

Remote command:

`FORMat[:DATA]` on page 439

Bit pattern format

Sets the format for all bit pattern queries.

Remote command:

`FORMat:BPATtern` on page 440

5.1.4 Localization settings

Access: "Menu" > "Settings" > "System" > "Localization".

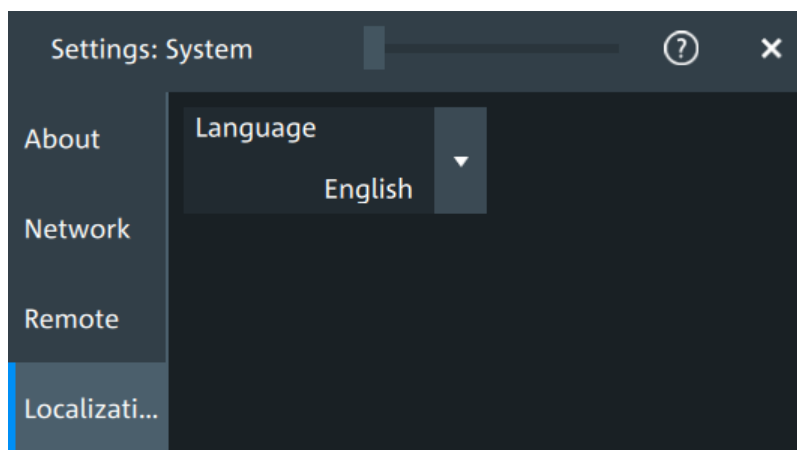

Language

Selects the language in which the dialog boxes, result boxes and other screen information is displayed. You can change the instrument language while the instrument is running.

Available languages are, for example, English, German, French, Japanese. For a complete list of supported languages, refer to the data sheet.

5.1.5 Date and time settings

Access: "Menu" > "Settings" > "System" > "Date/time".

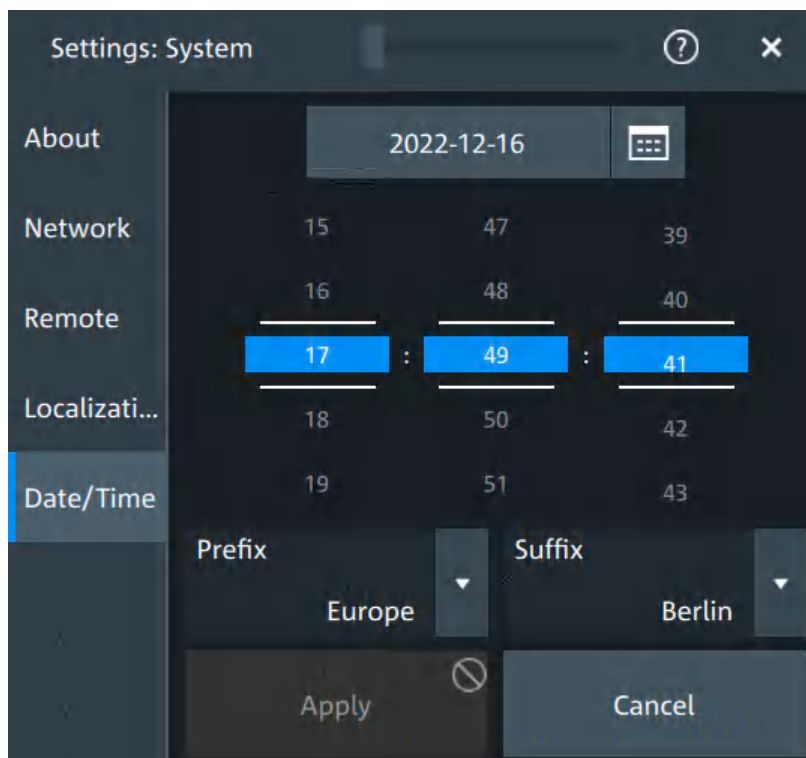

The instrument uses the system time of the operating system, but you can change date and time for the R&S MXO 5 firmware.

1. To change the date:
 - a) Tap the date button.
 - b) Select the date in the calendar.
 - c) Tap the blue calendar icon to close the calendar.
2. To change the time, move the hour, minute and second sliders to the required values.
3. Adjust the "Prefix" and "Suffix" to indicate your location.
4. Tap "Apply".

Remote command:

- `SYSTem:DATE` on page 441
- `SYSTem:TIME` on page 443

5.2 Option settings

Additional options for the R&S MXO 5 are enabled using a license key. To obtain the license key, consult your sales representative.



Unregistered licenses

Unregistered licenses are not assigned to a particular instrument. The instrument accepts only registered licenses. If your license is delivered unregistered, use the online tool R&S License Manager to register the license for your instrument. The registration of a permanent license is irreversible, so ensure that you register it for the correct instrument. The address of the tool is <https://extranet.rohde-schwarz.com/service>. For registration, you need the device ID of the instrument on which the option will be installed.

5.2.1 Software options settings

Access: "Settings" > "Options" > "Software"

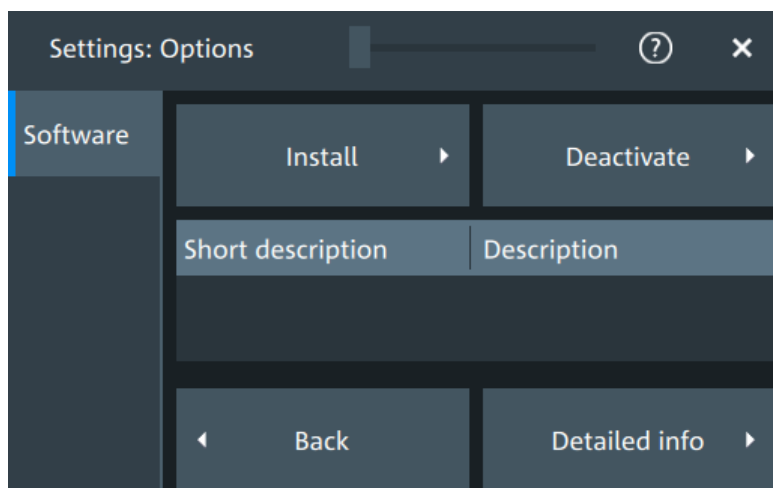

In this dialog, you can access settings for installing and deactivating options. In the "Detailed Info" dialog, you can get an overview of all options installed on your R&S MXO 5.

5.2.1.1 Install options

Access: "Settings" > "Options" > "Software" > "Install"

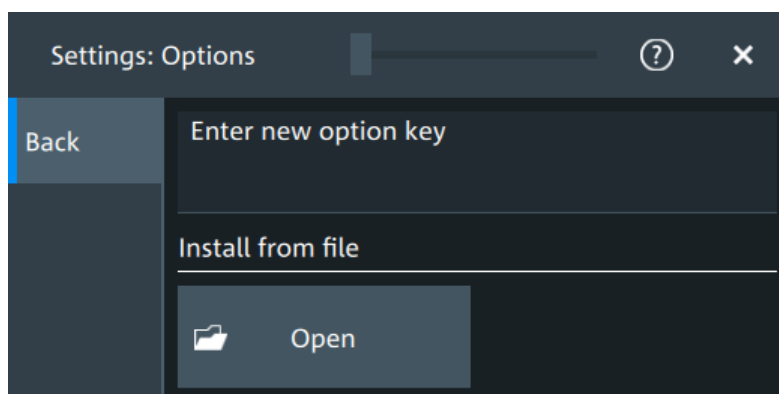

In the "Install" tab, you can install new options using license keys.

Enter new option key

Enter the license key here to activate the option. For license keys delivered as a file, use "[Install from file](#)" on page 77.

Install from file

If you got a license file, install the license here.

Tap "Open" to open the file selection dialog, or enter the complete path and filename.

5.2.1.2 Deactivate options

Access: "Settings" > "Options" > "Software" > "Deactivate"

When you deactivate an option, you might need to note the response key, or to save the response to a file. This is done in the "Deactivate" dialog.

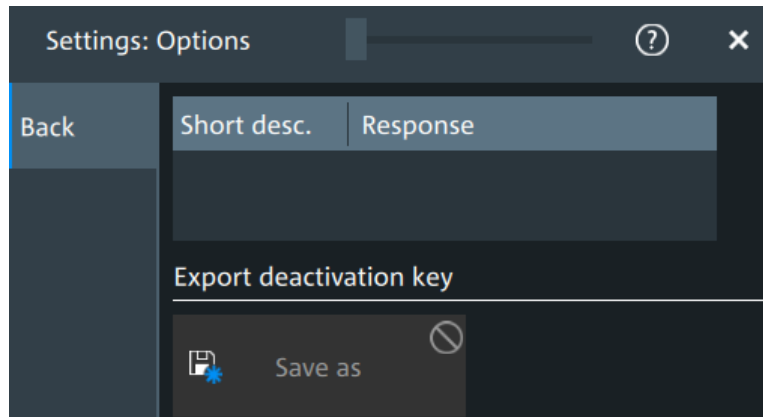

5.3 Appearance settings

In the "Settings" > "Appearance" dialog box, you define the look and feel of the display element, e.g. waveform colors, result position, or grid behavior.

Appearance settings are not included in user-defined presets. To reset all appearance settings at once, use the factory preset.

5.3.1 Colors

Access: "Settings" > "Appearance" > "Colors"

By default, various colors are assigned to the different waveform types for better visibility and distinguishability. You can change the color assignment and select another color or a color table to waveforms.

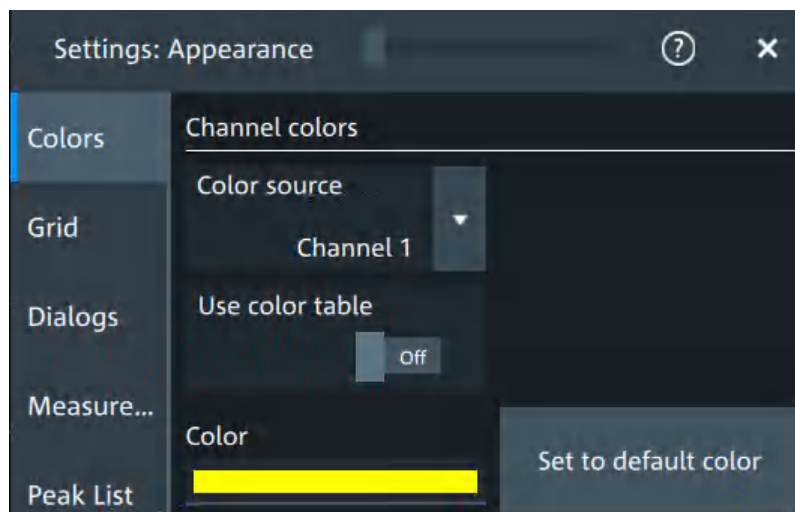

Color source

Selects the waveform to which the color or the color table is assigned.

Use color table

If enabled, the selected waveform is displayed according to its assigned color table.

If disabled, the selected color is displayed, and the intensity of the signal color varies according to the cumulative occurrence of the values.

Remote command:

`DISPlay:COLor:SIGNal:USE` on page 450

Assigned color table

Assigns a color table to the source waveform instead of a dedicated color. Color tables define the color of the waveform pixels depending on the cumulative occurrence of the associated values.

The following color tables are provided:

- "False colors": color changes gradually in a wide color spectrum.
- "Single Event": single events and very seldom events appear yellow, a higher cumulative occurrence is shown with blue color. This view helps to identify specific events.
- "Spectrum": colors display the wavelengths of the light. Low cumulative occurrence is displayed blue like high wavelength.
- "Temperature": color changes gradually from blue (low temperature) to red (high temperature) with increasing cumulative occurrence.

Remote command:

`DISPlay:COLor:SIGNal:ASSign` on page 450

Color

Shows the current color of the selected waveform. To change the color, tap the button to open the "Color" dialog.

In the dialog, you can pick from a list of basic colors, or define a color with the color picker.

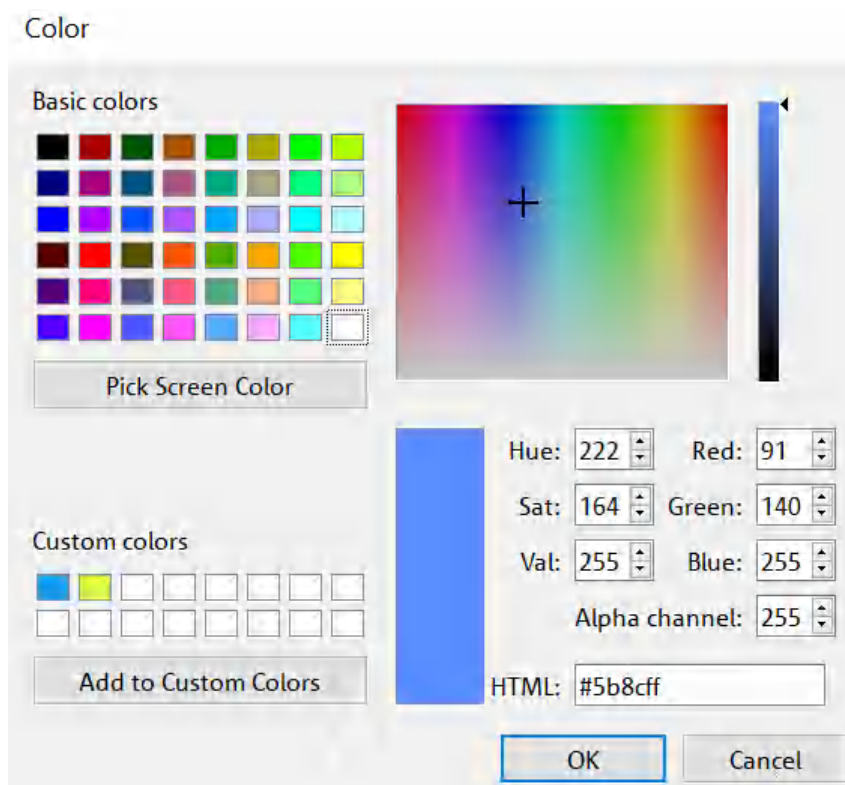

The color of the waveform, its signal icon, and of the illuminated keys is adjusted to the new color. If the waveform is a spectrum, the knobs for vertical scale and position retain the color of the spectrum's source.

Remote command:

`DISPlay:COLor:SIGNal:COLor` on page 450

Set to default color

Resets the color of the selected waveform to the factory default.

Remote command:

`DISPlay:COLor:SIGNal:COLor <Signal>,DEF`

5.3.2 Grid

Access: "Settings" > "Appearance" > "Grid"

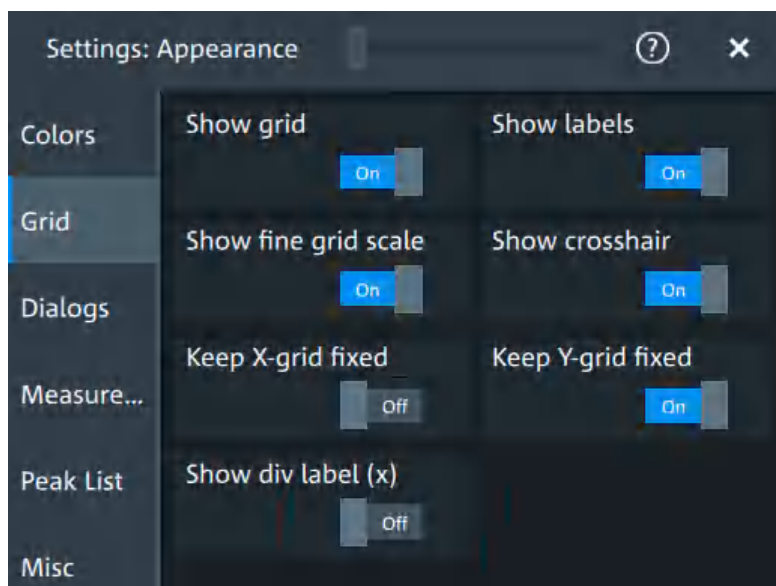
**Show grid**

If selected, a grid is displayed in the diagram area. A grid helps you associate a specific data point to its exact value on the x- or y-axis.

Remote command:

[DISPlay:DIAGram:GRID](#) on page 451

Show labels

If selected, labels mark values on the x- and y-axes in specified intervals in the diagram.

Remote command:

[DISPlay:DIAGram:LABels](#) on page 451

Show fine grid scale

If selected, the crosshair is displayed as a ruler with scale markers. If disabled, the crosshair is shown as dashed lines.

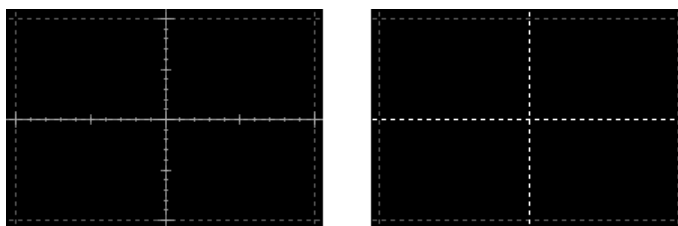

Remote command:

[DISPlay:DIAGram:FINeGrid](#) on page 451

Show crosshair

If selected, a crosshair is displayed in the diagram area. A crosshair allows you to select a specific data point by its coordinates.

Remote command:

[DISPlay:DIAGram:CROSShair](#) on page 451

Keep X-grid fixed

If enabled, the vertical grid lines remain in their position when the horizontal position is changed. Only the values at the grid lines are adapted.

Keep Y-grid fixed

If enabled, the horizontal grid lines remain in their position when the position of the curve is changed. Only the values at the grid lines are adapted.

Fixed horizontal grid lines correspond to the behavior of traditional oscilloscopes.

Remote command:

[DISPlay:DIAGram:YFIXed](#) on page 452

Show div label (x)

If selected, the time scale value is shown at the diagram bottom instead of the horizontal grid labels. For example, 10 ns/div is shown instead of the values 0, 10, 20, 30... ns.

5.3.3 Dialogs

Access: "Settings" > "Appearance" > "Dialogs"

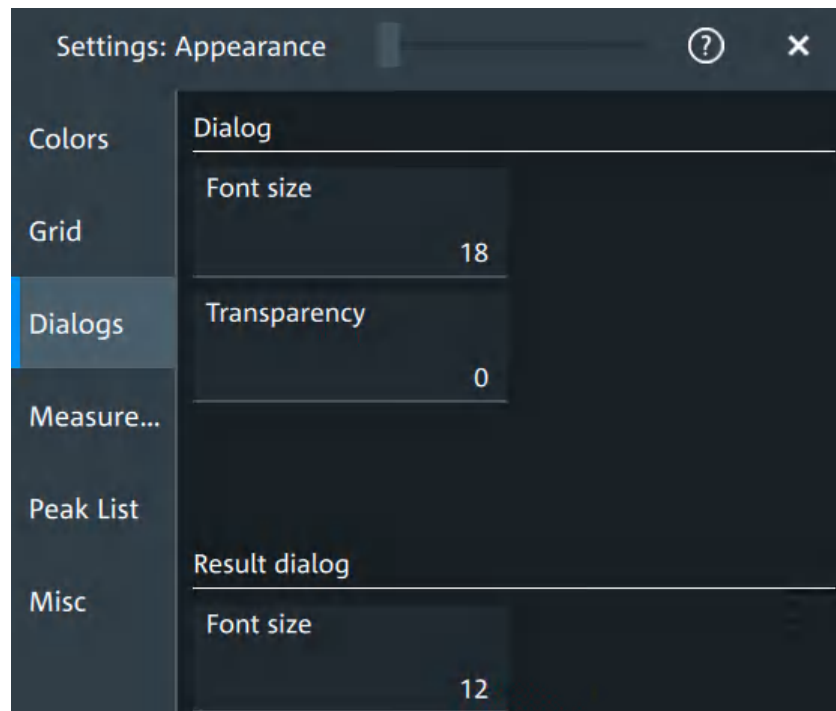

Font size (Dialog)

Sets the font size of the text in dialog boxes.

Remote command:

[DISPlay:DIALog:FONTsize](#) on page 452

Transparency (Dialog)

Sets the transparency of the dialog box background. For high transparency values, you can see the waveform display in the background, and possibly check the effect of the changed setting. For lower transparency values, readability in the dialog box improves.

You can also set the dialog transparency, by moving the transparency bar at the top of the dialog.



Remote command:

[DISPlay:DIALog:TRANsparency](#) on page 452

Font size (Result dialog)

Sets the font size of the text in result tables.

Remote command:

[DISPlay:RESult:FONTsize](#) on page 453

5.3.4 Peak list

Access: "Settings" > "Appearance" > "Peak list"

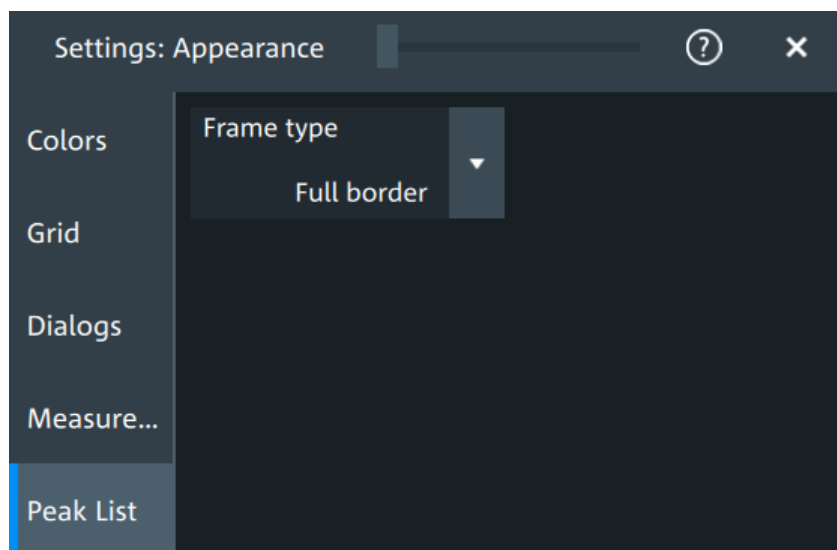

Peak list settings apply to peak list measurements. They are visible when the peak list for spectrum measurements is enabled.

Frame type

Defines the layout of the labels, full border or none.

Remote command:

[CALCulate:SPECTrum<sp>:PLISt:LABel:BOReR](#) on page 453

5.3.5 Miscellaneous

Access: "Settings" > "Appearance" > "Misc"

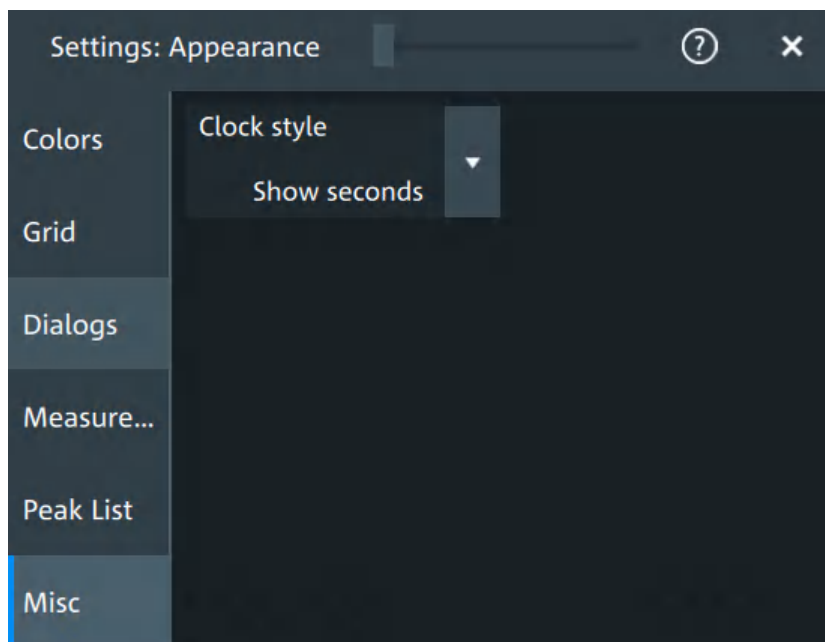

Clock style

Select how the clock in the upper right corner of the screen is displayed:

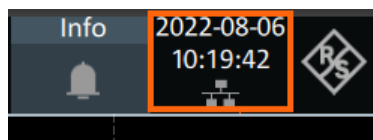

- "Show seconds": format is hh:mm:ss
- "Hide seconds": format is hh:mm
- "Hide clock": no time is shown

5.4 Display settings

In the "Settings" > "Display" dialog, you can define the display settings like brightness and signal intensity.

5.4.1 Persistence settings

Access: "Menu" > "Settings" > "Display" > "Persistence".

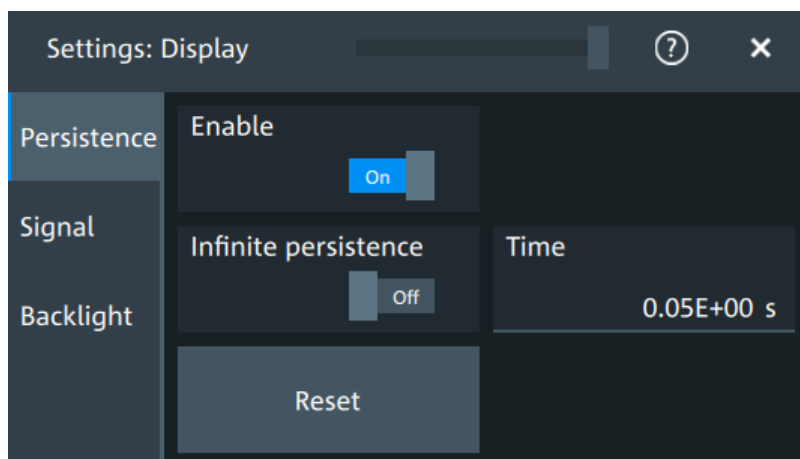

Enable

If enabled, each new data point in the diagram area remains on the screen for the duration that is defined using **Time**, or as long as **Infinite persistence** is enabled.

If disabled, the waveform points are displayed only for the current acquisition.

Remote command:

[DISPlay:PERStence\[:STATe\]](#) on page 454

Infinite persistence

If infinite persistence is enabled, each new waveform point remains on the screen until this option is disabled. Use infinite persistence to display rare events in the signal.

Remote command:

[DISPlay:PERStence:INFinite](#) on page 454

Time

Sets a time factor that controls how long the waveforms points fade away from the display. Thus, the R&S MXO 5 emulates the persistence of analog phosphor screens.

Remote command:

[DISPlay:PERStence:TIME](#) on page 454

Reset

Resets the display, removing persistent all waveform points.

Remote command:

[DISPlay:PERStence:RESet](#) on page 454

5.4.2 Signal settings

Access: "Menu" > "Settings" > "Display" > "Signal".

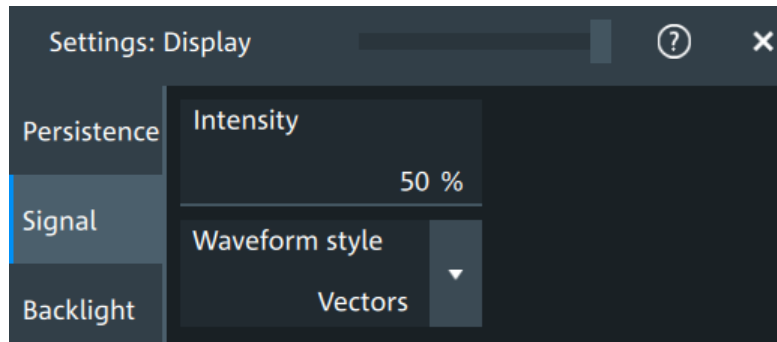

Intensity

The intensity determines the strength of the waveform line in the diagram. Enter a percentage between 0 (not visible) and 100% (strong). The default value is 50%.

You can also use the [Intensity] knob to adjust the waveform intensity directly.

Remote command:

[DISPlay:INTensity](#) on page 455

Waveform style

Selects the style in which the waveform is displayed.

- "Vectors" The individual waveform points are connected by a line. Define the strength of the line using the [Intensity] knob.
- "Dots" Only the individual waveform points are displayed. To see the dots of one waveform, perform one acquisition with [Single] and N=1 ([N-single/Avg count](#)). During continuous acquisition, or a [Single] acquisition with N > 1, the dots of multiple subsequent waveforms are displayed on the screen, and the waveform looks like a line.

Remote command:

[DISPlay:DIAGram:STYLE](#) on page 455

5.4.3 Backlight settings

Access: "Menu" > "Settings" > "Display" > "Backlight".

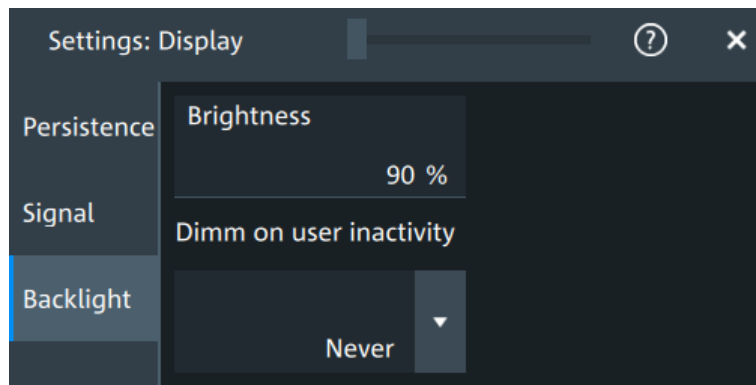

Brightness

Sets the background luminosity of the touchscreen.

Remote command:

[DISPlay:BACKlight\[:BRIGtness\]](#) on page 455

Dimm on user inactivity

Selects a time, after which the monitor brightness is reduced, if the instrument was inactive. Remote control of the instrument is also considered as an activity.

Remote command:

[DISPlay:BACKlight:DIMMING](#) on page 456

5.5 Front panel settings

In the "Front Panel" dialog box, you can assign functions to keys and knobs and adjust the brightness of the keys.

5.5.1 Hardkeys: function assignment

Access: "Settings" > "Front Panel" > "Hardkeys"

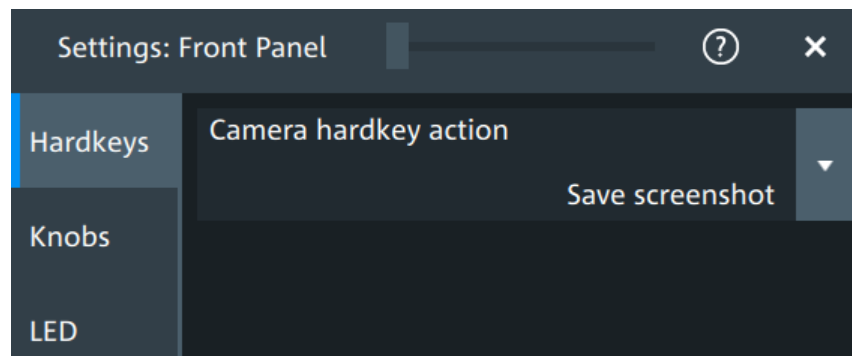
**Camera hardkey action**

The Camera key on the bottom right is a shortcut key that initiates an associated action.

You can assign one of the following actions:

- Save screenshot
- Open screenshot setup

Configure the settings for the selected action.

- Screenshots: "Save/Recall" key > "Save" tab > "Screenshot", see [Chapter 12.4, "Screenshots"](#), on page 280.

5.5.2 Knobs

Access: "Settings" > "Front Panel" > "Knobs"

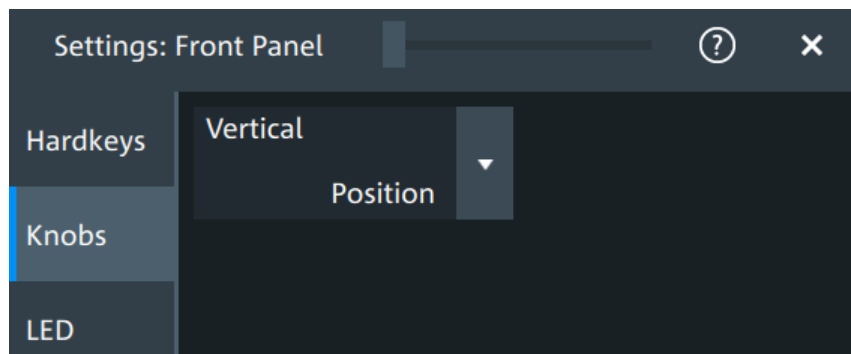

Vertical

The vertical Position knob can change the waveform position or the offset of the selected waveform. Select the action that you want to perform.

See also: "[Position]" on page 39.

5.5.3 LED

Access: "Settings" > "Front Panel" > "LED".

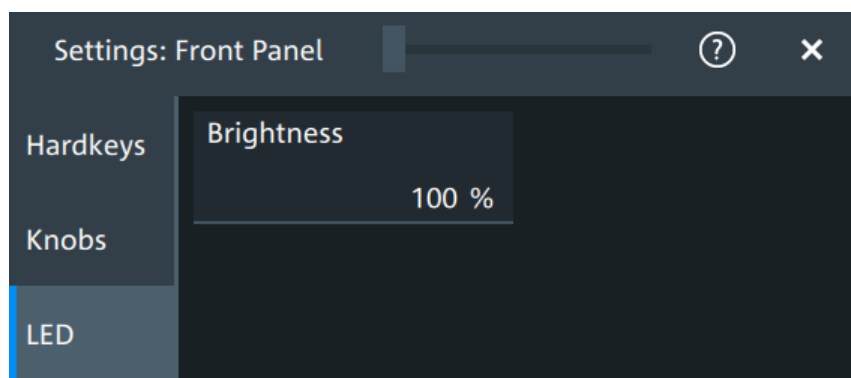

Brightness

Defines the luminosity of illuminated front panel keys and knobs.

5.6 Preset setup

The preset sets the instrument to a default configuration, or to a user-defined configuration. A user-defined preset file is one of the saveset files, which are stored on the instrument. It contains the measurement setup, while the user's display settings are not included. You can save the current configuration to a preset file, and enable saved preset file to be applied with the [Preset] key.

See also: [Chapter 12.1, "Save and recall user settings"](#), on page 267.

5.6.1 Preset settings

Access: "Menu" > "Settings" > "Preset" > "Settings".

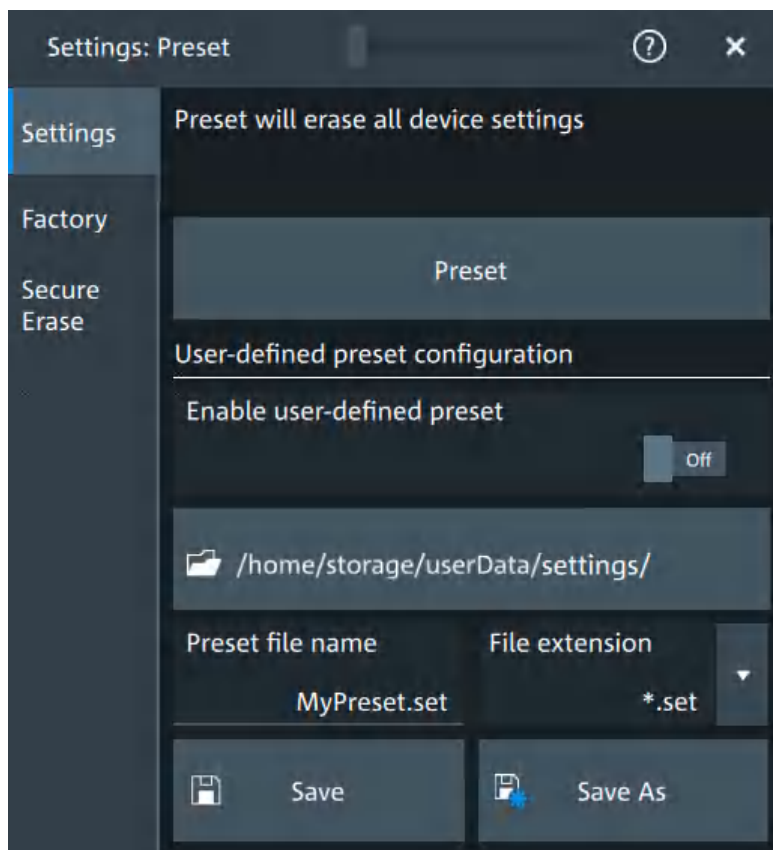

Preset

Set the instrument to a default configuration, or to a user-defined configuration.

Enable user-defined preset

If enabled, the settings from the selected saveset are restored when the [Preset] key is pressed.

If disabled, [Preset] sets the instrument to the factory defaults.

Saveset to be loaded on preset

Select the saveset file that contains the required settings. If "Enable user-defined preset" is enabled, this saveset is loaded when you press the [Preset] key.

"Preset file name" Enter the filename of the preset file. This file is loaded on user-defined preset. The filename is also used when you save a preset file with "Preset file name".

"File extension" The file extension is `.set`.

<Directory> Shows the currently used directory. To change the directory, tap the button and select the correct directory in the file dialog.

Save as, Save

"Save as" opens the file selection dialog, where you can select the directory and enter the filename of the preset file. "Save" saves the current settings immediately to the file that is named in "Preset file name" in the current directory.

5.6.2 Factory preset

Access: "Menu" > "Settings" > "Preset" > "Factory".

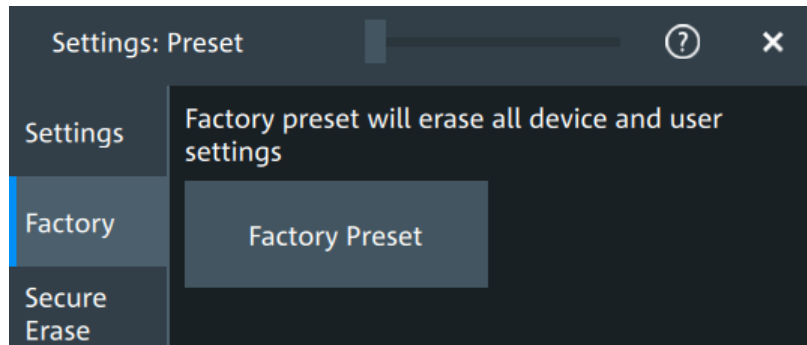
**Factory preset**

Resets the instrument to the factory default settings, to the initial state. Factory settings comprise all instrument settings, including display, intensity and transparency settings.

Remote command:

[SYSTem:PRESet](#) on page 442

5.6.3 Secure erase

Access: "Menu" > "Settings" > "Preset" > "Secure erase"

To purge all non-volatile memory, a special delete function is available. This function erases all user data, including instrument setups and reference waveforms. Calibration data is retained on the instrument. The instrument reboots after erasing the data.

The procedure is required if user data must not leave the test area with the instrument, e.g. when working in highly secured environments.

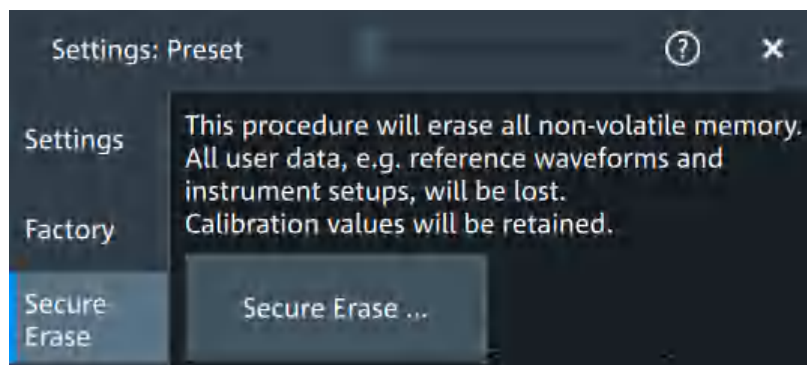

5.6.4 Restoring settings

When you have changed many settings on the instrument, and you are not sure which settings are causing which effect, you can restore the default settings and start anew. The following methods are available:

- Saving instrument settings as a user-defined preset and restoring the instrument settings to user-defined default values
- Restoring all settings on the R&S MXO 5 to the factory-defined values
- Restoring settings from a file

To save a user-defined preset

1. Open the "Menu" > "Settings" > "Preset" tab.
2. Enter a name for the preset file. Select the file format.
3. Tap "Save preset file".

Note: If you want to store the file in another directory than the displayed one, select "Save as". See also: [Chapter 12.5, "File browser dialog"](#), on page 283.

To restore the instrument settings to user-defined default values

1. Open the "Menu" > "Settings" > "Preset" > "Settings" tab.
2. In "Preset file name", enter the name of the file that contains the required settings.
3. To use these settings as preset values, select "Enable user-defined preset".
4. Press the [Preset] key.

To restore all settings to the factory defaults

1. Open the "Menu" > "Settings" > "Preset" > "Factory" tab.
2. Tap the "Factory preset" button.

All settings on the R&S MXO 5 are reset to their factory-defined values.

As long as no user-defined preset file is loaded and "Enable user-defined preset" is disabled, the [Preset] key also resets the instrument settings to factory defaults.

5.7 Maintenance settings

In the "Settings" > "Maintenance" dialog box, you can update the firmware, perform self-alignment.

5.7.1 Firmware update

Access: "Menu" > "Settings" > "Maintenance" > "FW update".

Your instrument is delivered with the latest firmware version. Firmware updates are provided on the internet at:

The "Release Notes" describe the improvements and modifications of all firmware versions. They also explain how to update the firmware. They are available along with the firmware on the same web page.

Remote commands:

- `SYSTem:FW:FILEpath` on page 442
- `SYSTem:FW:STARt` on page 443

5.7.2 Alignment

When data from several input channels is displayed at the same time, it can be necessary to align the data. Alignment is done vertically or horizontally to synchronize the time bases or amplitudes and positions. Perform an alignment, for example, when strong temperature changes occur ($> 5^\circ$).

5.7.2.1 Alignment settings

Access: "Menu" > "Settings" > "Maintenance" > "Alignment"

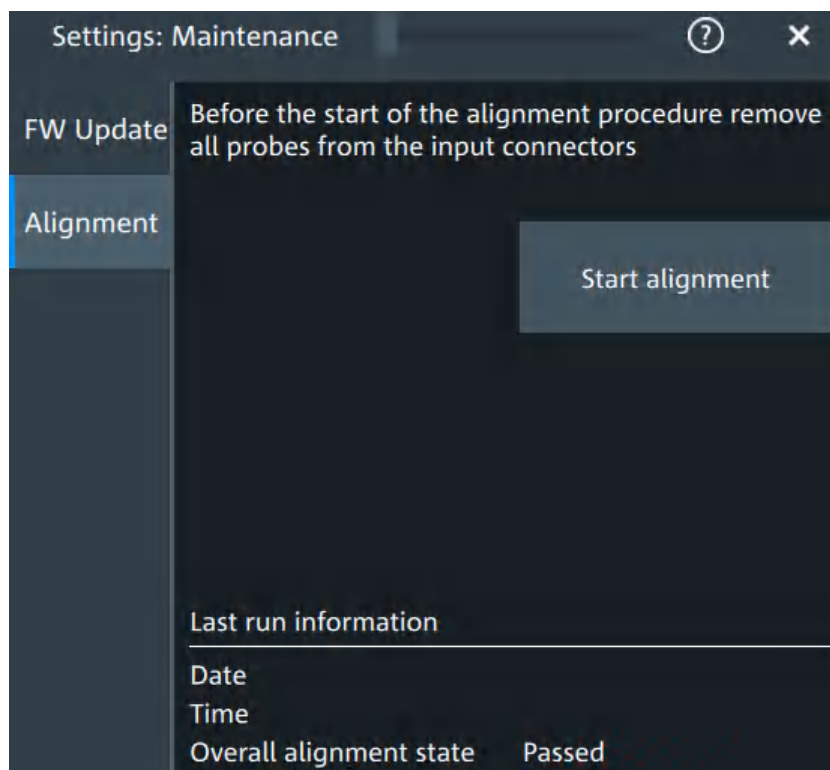

Start alignment

Starts the self-alignment procedure for all channels.

Date, Time, Overall alignment state

Show the date, time and the summary result of the self-alignment process: not aligned, passed or failed. Detailed results are provided on the "Alignment results" tab.

Remote command:

[CALibration:DATE?](#) on page 459

[CALibration:TIME?](#) on page 459

[CALibration:RESult?](#) on page 459

Show results

Opens a dialog to display the alignment results.

For each channel, the results of the individual alignment steps are shown for all technical channel component. In case you require support, you may be asked to provide this information.

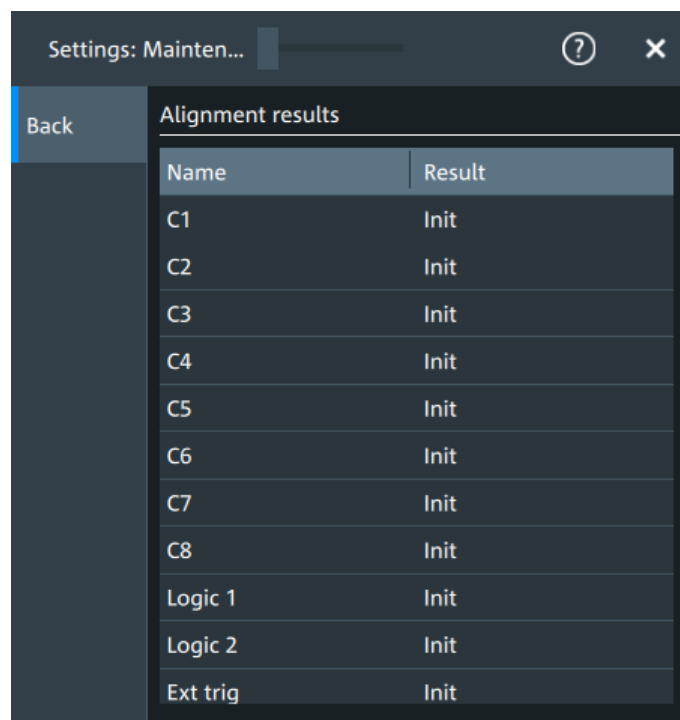

Name	Result
C1	Init
C2	Init
C3	Init
C4	Init
C5	Init
C6	Init
C7	Init
C8	Init
Logic 1	Init
Logic 2	Init
Ext trig	Init

5.7.2.2 Performing a self-alignment

The self-alignment aligns the data from several input channels vertically and horizontally to synchronize the timebases, amplitudes and positions. The self-alignment process includes a basic hardware check.

Recommendation on performing the self-alignment:

- When putting the instrument into operation for the first time
- After a firmware update
- Once a week
- When major temperature changes occur (> 5°)

1. Warm up the instrument before you start the self-alignment. The minimum warm-up time is indicated in the data sheet.
2. Remove the probes from the input connectors.
3. Open "Menu" > "Settings" > "Maintenance".
4. In the "Alignment" tab, tap "Start alignment".

The alignment is performed, the process can take several minutes. A message box informs you about the running process, wait until this message box closes. The overall pass/fail result is shown in the "Overall alignment state" field.

5.7.3 Power management

Access: "Menu" > "Settings" > "Maintenance" > "Power mgmt."

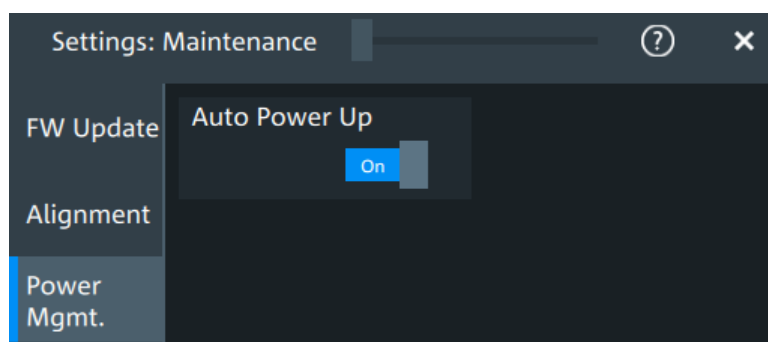

Auto power up

If enabled, the instrument powers up automatically when it is connected to the mains voltage.

Remote command:

[SYSTem:APUP](#) on page 460

5.7.4 Service

Access: "Menu" > "Settings" > "Maintenance" > "Service"

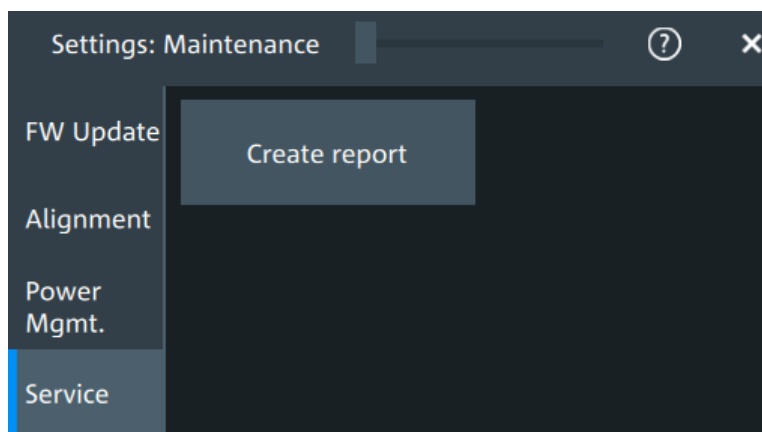

Create report

Creates a service report.

The service report is a ZIP file with a complete bug report, all relevant setup information, reporting and log files, alignment files, and the instrument configuration.

If a USB flash drive is connected, the report is saved on the USB flash drive. Otherwise, the report is saved in the user data folder `/home/storage/userData`.

See also: [Chapter 18.4, "Information for technical support"](#), on page 792.

Remote command:

`SERvice:REPort` on page 459

5.8 Save / recall

5.8.1 Autonaming

Access: "Menu" > "Settings" key > "Save/Recall" > "Autonaming" tab.

5.8.1.1 Autonaming settings

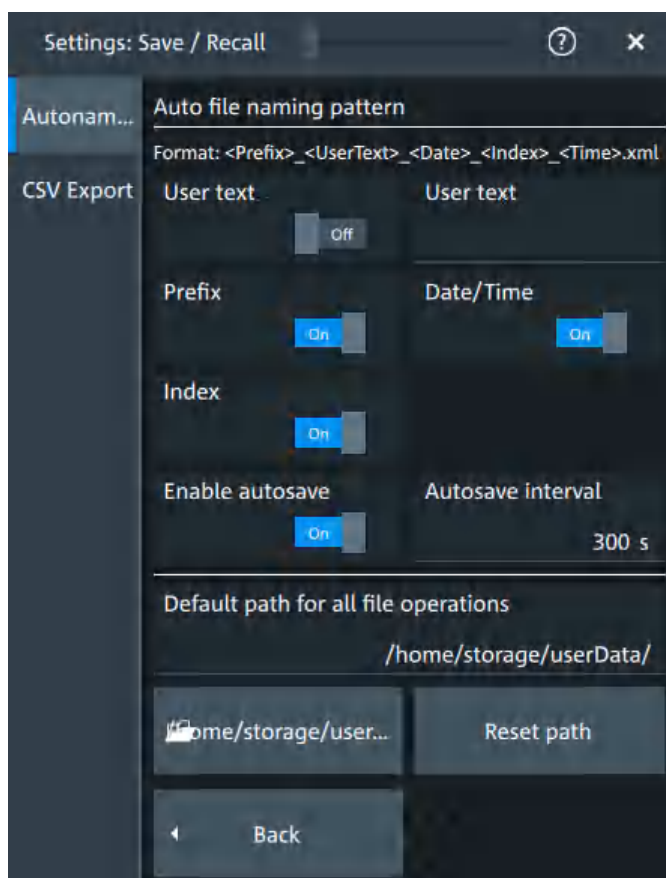

In the "Autonaming" tab, you can define the pattern for automatic file name generation. This name is used as the default file name. The default path is the storage location for all saved files and their subdirectories. The directory for user data on the instrument is `/home/storage/userData`, the path to a USB storage device is `/run/media/usb/`.

User text

If enabled, inserts the specified user text after the prefix.

Remote command:

[MMEMory:AUTonaming:USERtext](#) on page 457

[MMEMory:AUTonaming:TEXT](#) on page 458

Prefix

If enabled, inserts the default prefix in the file name. The prefix indicates the type of data that is saved, for example, RefCurve, Settings.

Remote command:

[MMEMory:AUTonaming:PREFix](#) on page 456

Date/time

If enabled, the current date and time are inserted in the filename pattern.

Remote command:

[MMEMory:AUTonaming:TIME](#) on page 456

Index

If enabled, inserts an index.

Remote command:

[MMEMory:AUTonaming:INDEX](#) on page 456

Enable autosave

Enables the automatic saving of the waveform. With "Autosave interval", you can define the time interval for the automatic saving.

Remote command:

[MMEMory:AUSave:ENABLE](#) on page 457

[MMEMory:AUSave:INTERval](#) on page 457

Default path for all file operations

Defines the path that is displayed in the file selection dialog box for loading and storing operations. On the instrument, all user data is written to `/home/storage/userData`. You can create subfolders in this folder. The path to a USB storage device is `/run/media/usb/`.

To switch the directory quickly, double-tap the path button. Use the symbols on the left of the file explorer box to change the directory.

Remote command:

[MMEMory:AUTonaming:DEFAULTpath](#) on page 458

Reset path

Resets the default file path to the factory default.

Remote command:

[MMEMory:AUTonaming:RESPath](#) on page 458

[MMEMory:AUTonaming:RESall](#) on page 458

5.8.1.2 Defining default file paths and names

When a save or load operation is performed, a default file name and path is provided. You can configure which path is used and how the file name is generated. In the file selection dialog box, you can change the folder and name as desired.

To define the default file path

1. Tap "Menu" > "Settings".
2. Select the "Save/Recall" tab.
3. Select the "Autonaming" tab.
4. Double-tap the path button.
The directory selection dialog box is opened.

5. Select the folder in which the data is stored by default. Use the symbols on the left of the file explorer box to switch to often used directories.
Alternatively, you can tap the "Default path for all file operations" field and type the path.
6. To restore the factory-set default path, tap "Reset" next to the path field.

To define the automatic file name pattern

The automatic file name pattern can consist of the following elements:

<Prefix>_<UserText>_<Date>_<Index>_<Time>

The prefix depends on the data type to be stored and cannot be changed by the user. The other elements can be enabled or disabled as required.

1. Tap "Menu" > "Settings".
2. Select the "Save/Recall" tab.
3. Select the "Autonaming" tab.
4. If you want to exclude the "Prefix", "Date/time" or an "Index" (serial number), disable the corresponding option.
5. To insert a user-defined text after the prefix, enable "User text". Enter the text in the edit field.

The specified elements are used to generate the default file name for the next storage operation.

5.8.2 CSV export

Access:"Menu" > "Settings" key > "Save/Recall" > "CSV export" tab.

In this dialog, you can define the format of your CSV file.

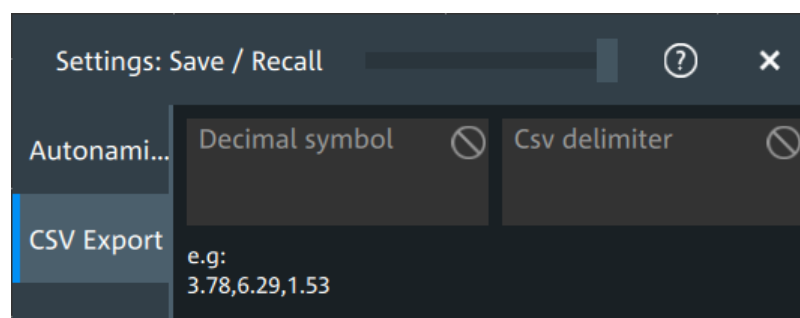

Decimal symbol

Selects if point or comma is used as a decimal symbol in the exported CSV file.

CSV delimiter

Selects the list separator symbol from a list. Available are semicolon, comma, space, tab and colon.

Remote command:

`EXPort:RESult:DELimiter` on page 458

6 Acquisition and waveform setup

6.1 Horizontal setup

The "Horizontal" dialog provides the time base configuration for channel and spectrum waveforms.

6.1.1 About the horizontal system

Horizontal settings, also known as timebase settings, adjust the waveforms in horizontal direction.

Typically, the trigger is the determining point of the waveform record. In many scenarios, you want to analyze the waveform some time before or after the trigger. To adjust the horizontal acquisition window to the waveform section of interest, you can use the following parameters:

- The **horizontal position** defines the time distance of the trigger point (the zero point of the diagram) to the reference point. Changing the horizontal position, you can move the trigger point, even outside the screen.
- The **reference point** is the rescaling center of the time scale on the screen. If you modify the time scale, the reference point remains fixed on the screen, and the scale is stretched or compressed to both sides of the reference point.

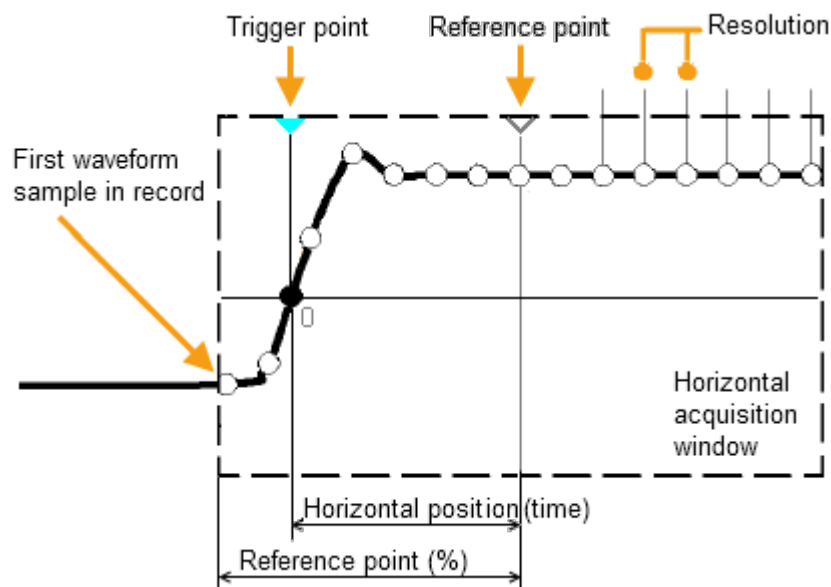

Unlike vertical settings, which are waveform-specific, the horizontal settings apply to all active waveforms.

Timebase settings are interdependent:

$$\text{Timebase range} = \text{Time scale} * \text{Number of divisions}$$

The number of divisions is 10, which is the only constant parameter.

6.1.2 Horizontal Setup settings

Access: "Menu" > "Horizontal" > "Setup" tab, or tap the "Horizontal" label above the diagram.

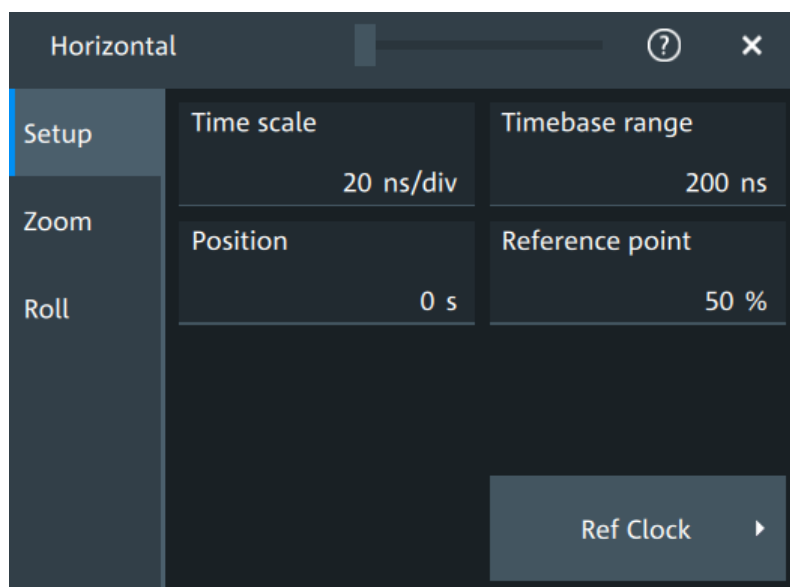

Time scale

Sets the horizontal scale, the time per division, for all waveforms in the time domain, for example, channel and math waveforms.

Increase the scale to see a longer time interval of the waveform. Decrease the scale to see it in more detail. The scale has a point that remains fixed on the screen when the scale value is changing: the reference point.

Remote command:

[TIMEbase:SCALE](#) on page 461

Timebase range

Sets the time of one acquisition, which is the time across the 10 divisions of the diagram: *Acquisition time = Time scale * 10 divisions*.

Changing the acquisition time changes the time scale, too.

For long timebases, the acquisition progress is shown in the acquisition label, see "[Progress information](#)" on page 66.

Remote command:

[TIMEbase:RANGe](#) on page 461

Position

Defines the time distance between the reference point and the trigger point, which is the zero point of the diagram. The horizontal position is also known as trigger offset.

If you want to see a section of the waveform some time before or after the trigger, enter this time as horizontal position. The requested waveform section is shown around the reference point. Use positive values to see waveform sections after the trigger - the waveform and the diagram origin move to the left.

Remote command:

`TIMEbase:HORizontal:POSition` on page 462

Reference point

Sets the position of the reference point in % of the screen. It defines which part of the waveform is shown.

The reference point marks the rescaling center of the time scale on the screen. If you modify the time scale, the reference point remains fixed on the screen, and the scale is stretched or compressed to both sides of the reference point. If the "Position" is 0, the trigger point is on the reference point.

The reference point is not marked in the diagram.

Remote command:

`TIMEbase:REFerence` on page 462

6.1.3 Zoom settings

The zoom settings are described in [Chapter 8.1, "Zoom"](#), on page 160.

6.1.4 Roll mode

Access: "Menu" > "Horizontal" > "Roll" tab.

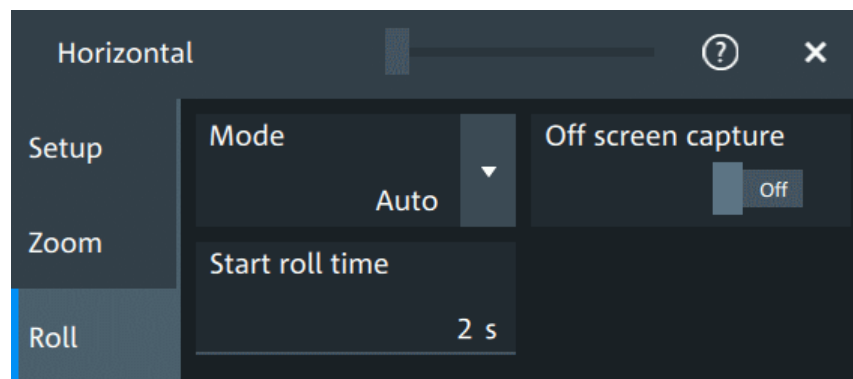

In this dialog, you can define the behavior of the roll mode.

Progress bar

The "Roll" progress bar in the "Acquisition" label shows how the record length is filled. The bar turns green when all samples are acquired, and the record is filled.

Acquisition			
1 MSa/s	Sample	Roll	
10 Mpts	12 bit	RL: 6.14 Mpts	
Acquisition			
1 MSa/s	Sample	Roll	
10 Mpts	12 bit	RL: 36.7 Mpts	
Acquisition			
1 MSa/s	Sample	Roll	
10 Mpts	12 bit	RL: 36.7 Mpts	

Left = incomplete roll waveform
Middle = roll completed with "Off screen capture" = Off
Right = roll completed with "Off screen capture" = On

Mode

Selects, if the roll mode is set automatically by the instrument or if it is turned off.

In roll mode, the instrument shows the waveforms immediately, without waiting for the complete acquisition of the waveform record. If the time base is slow - at long time scale values - the roll mode saves waiting for the waveform display. The instrument displays newly acquired waveform points at the right edge of the display and moves the waveform to the left.

The roll mode has following restrictions:

- Roll mode disables persistence
- Event actions are not possible

The instrument activates the roll mode automatically if the following conditions are fulfilled:

- "Timebase range" exceeds the defined "Start roll time"
- The "Acquisition mode" is set to "Sample" or "Peak detect"
- "N-single/Avg count" = 1
- Fast segmentation is disabled
- Event actions are disabled
- All serial buses are disabled

Measurement statistics evaluate the currently displayed waveform. Therefore, "Measure all events" is enabled automatically in roll mode.

Remote command:

[TIMEbase:ROLL:ENABLE](#) on page 463

[TIMEbase:ROLL:STATE?](#) on page 464

Start roll time

Sets the minimum acquisition time for automatic start of the roll mode.

The instrument activates the roll mode automatically if the "Timebase range" exceeds the value of the "Start roll time".

Remote command:

[TIMEbase:ROLL:MTIME](#) on page 463

Off screen capture

If enabled, the analyzable waveform in roll mode is extended. Samples that arrive the left edge of the display are kept, they are moved to the invisible area on the left.

After stopping the acquisition, you can analyze the complete roll waveform, including the invisible part:

- Increase the "Time scale" to see a longer part of the waveform.
- Scroll the waveform: tap and drag the waveform to the right.

The "Roll" progress bar in the "Acquisition" label shows how the record length is filled, see "Progress bar" on page 102. If "Off screen capture" = Off, the analyzable record length is the value that is set in the "Acquisition" > "Setup" tab. If "Off screen capture" = On, the analyzable record length is longer. The value is shown in the progress bar when the bar is green, or returned by the remote command `ACQUIRE:ROLLmode:POINTs?`.

Remote command:

`ACQUIRE:ROLLmode:OSCapture` on page 463

`ACQUIRE:ROLLmode:POINTs?` on page 464

6.1.5 Reference clock

Access: "Menu" > "Horizontal" > "Setup" tab > "Ref Clock"

The oven-controlled crystal oscillator (OCXO) produces a 10 MHz internal reference signal with precise and stable frequency. You can output this clock signal for synchronization of other instruments. Conversely, you can also use an external 10 MHz reference signal. The input and output connectors for reference signals are on the rear panel of the instrument.

Use external ref. clock

Enables the use of an external 10 MHz reference signal instead of the internal reference clock.

Remote command:

`SENSe[:ROSCillator]:SOURCE` on page 492

Output 10 MHz ref. signal

Sends the internal reference clock signal to the Ref Out 10MHz connector.

If "Use external ref. clock" is enabled, the external reference signal is output instead of the internal clock.

Remote command:

`SENSe[:ROSCillator]:OUTPUT[:ENABLE]` on page 491

6.2 Acquisition

Access: "Menu" > "Acquisition".

Acquisition settings define the processing of the captured samples in the instrument.

6.2.1 About the acquisition system

Sampling and processing

The A/D converter samples the continuous signal under test at specific points in time and captures digital values. The converter is working at a constant rate specified in GHz.

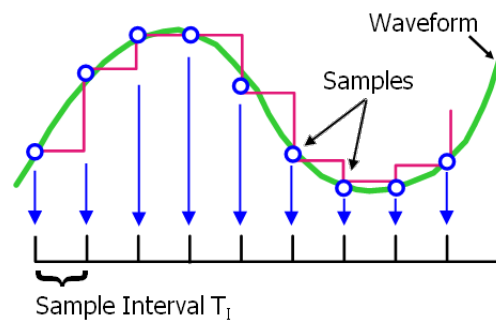

The captured values are processed according to the acquisition settings. The result is a waveform record that contains **waveform samples** and is stored in the **waveform memory**. The waveform samples are displayed on the screen and build up the waveform.

The number of waveform samples in one waveform record is called **record length**. The rate of recording waveform samples - the number of waveform samples per second - is the **sample rate**. The higher the sample rate, the better the resolution is and the more details of the waveform are visible.

$$\text{Sample rate} = 1 / \text{Resolution}$$

The sample rate can be the same as the constant rate of the A/D converter, or higher, or lower. To get a higher sample rate, interpolation is used. Several interpolation methods are available. Other processing methods reduce the sample rate, or build the resulting waveform from several consecutive acquisitions of the signal. These methods are called acquisition modes.

Minimum sample rate and aliasing

A sufficient resolution is essential for correct reconstruction of the waveform. If the signal is undersampled, aliasing occurs - a false waveform is displayed. To avoid aliasing and accurately reconstruct a signal, the sample rate must be at least 3 to 5 times the fastest frequency component of the signal. A higher sample rate increases signal fidelity, increases the chance to capture glitches and other signal anomalies, and improves the zoom-in capabilities.

Interleaving

The R&S MXO 5 with **8 channels** achieves its highest sample rate of 5 Gsample/s by interleaving channels by twos. Interleaving assumes that only one of the paired channels is used. If the second channel of a pair is used (on display, or as trigger source, math source, or measurement source), the interleaving mode is disabled. Without interleaving, the channels work with 2.5 Gsample/s and reduced bandwidth.

The interleaved channels of an 8-channel oscilloscope are:

- C1 and C5
- C2 and C6
- C3 and C7
- C4 and C8

The **4-channel** R&S MXO 5 is always in interleaving mode, and all 4 channels work with 5 Gsample/s and maximum bandwidth.

6.2.2 Acquisition Setup settings

Access: "Menu" > "Acquisition" > "Setup" tab.

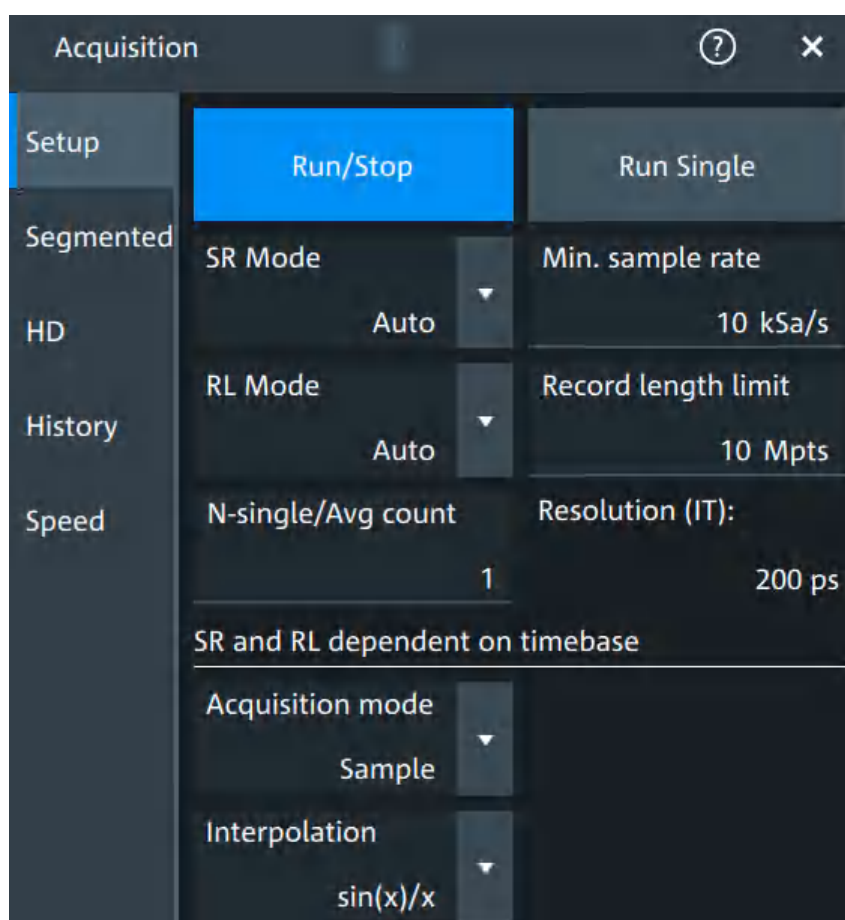

Figure 6-1: Acquisition settings: automatic sample rate and record length

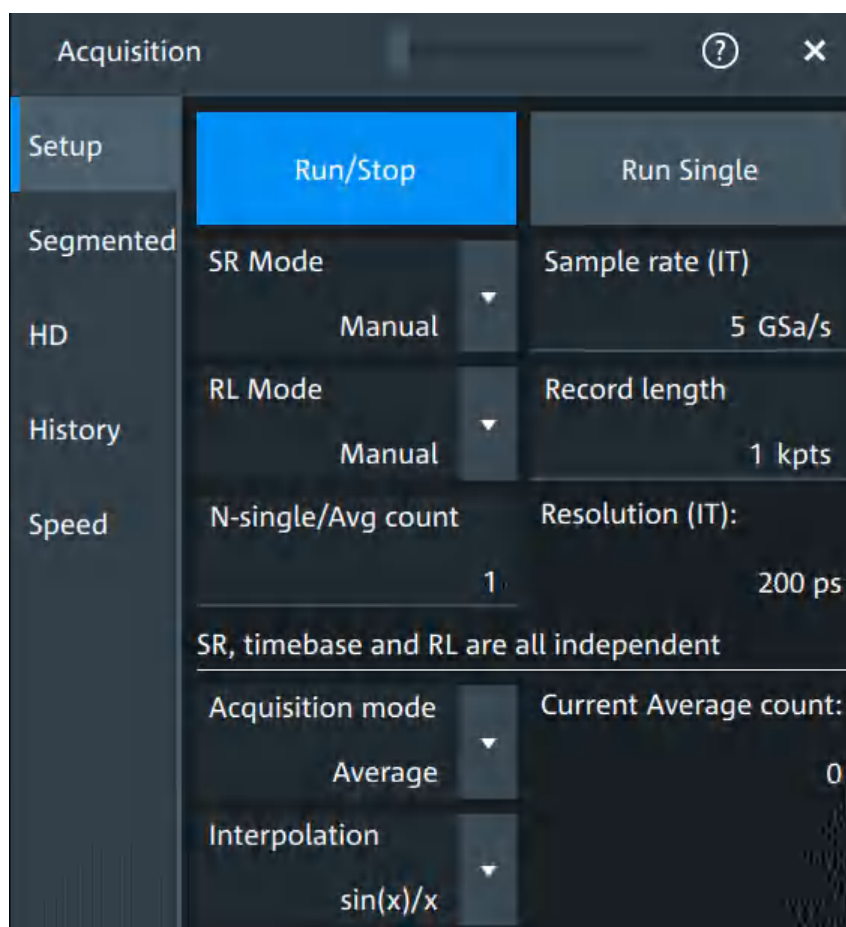

Figure 6-2: Acquisition settings: manual sample rate and record length

Run/Stop

Starts and stops the continuous acquisition. The [Run / Stop] key lights green when the acquisition is running. When the acquisition is stopped, the key lights red.

Remote command:

[RUN](#) on page 460

[STOP](#) on page 461

Run Single

Starts a defined number of acquisitions. The [Single] key lights green when the acquisition is running. When the acquisition is stopped, the key lights red.

To set the number of acquisitions, set "N-single/Avg count" in the "Acquisition" setup. The acquisition progress is shown in the acquisition label, see "[Progress information](#)" on page 66.

Remote command:

[SINGLE](#) on page 460

SR mode

Defines how the sample rate is set.

"Auto"	Sample rate is determined automatically and changes due to instrument internal adjustments due to other setting changes.
"Manual"	The sample rate is manually defined with "Sample rate", "Min. sample rate".

Remote command:

[ACQUIRE:SRATE:MODE](#) on page 475

RL mode

Selects the mode of the waveform record length adjustment.

"Auto"	Record length is determined automatically and changes due to instrument internal adjustments due to other setting changes.
"Manual"	The waveform record length is manually defined with "Record length", "Record length limit".

Remote command:

[ACQUIRE:POINTS:MODE](#) on page 473

Sample rate, Min. sample rate

Sets the number of waveform points per second in manual sample rate mode. In automatic sample rate mode, it sets the minimum value of the sample rate for automatic calculation.

The sample rate considers the samples of the ADC, and the processing of the captured samples including interpolation.

The setting is relevant, if "SR mode" is set to "Manual".

Remote command:

[ACQUIRE:SRATE\[:VALUE\]](#) on page 474

Record length, Record length limit

Sets the record length in manual record length mode. In automatic record length mode, it sets the maximum value of the record length for automatic calculation.

The record length is the number of waveform samples that are stored in one waveform record after processing, including interpolation.

Remote command:

[ACQUIRE:POINTS\[:VALUE\]](#) on page 473

N-single/Avg count

The acquisition and average count has several effects:

- It sets the number of waveforms acquired with [Single].
- It defines the number of waveforms used to calculate the average waveform. Thus, the instrument acquires sufficient waveforms to calculate the correct average if "Average" is enabled for waveform arithmetic. The higher the value is, the better the noise is reduced.
- It sets the number of acquisitions to be acquired in a fast segmentation acquisition series, and in the history.

The setting is read-only if "Segmented" > "Acquire maximum" is "On". See also ["Acquire maximum"](#) on page 110.

Remote command:

[ACQUIRE:COUNT](#) on page 472

Resolution

Defines the time between two waveform samples in the waveform record. It considers the processing of the captured samples including interpolation. A fine resolution with low values produces a more precise waveform record.

The resolution is the reciprocal of the sample rate.

Remote command:

[ACQUIRE:RESOLUTION](#) on page 474

Acquisition mode

Sets how the waveform is built from the captured samples.

"Sample"	Usually, most signals are displayed optimally with this acquisition mode but very short glitches can remain undiscovered by this method.
"Peak detect"	The minimum and the maximum of n samples are recorded as waveform points, the other samples are discarded. Thus the instrument can detect fast signal peaks at slow time scale settings that would be missed with other acquisition modes.
"Envelope"	Each acquisition is done in sample mode, and the minimum and maximum values over some consecutive acquisitions build the envelope.
"Average"	The average is calculated from the data of the current acquisition and a specific number of consecutive acquisitions before. The method reduces random noise. It requires a stable, triggered and repetitive signal. The number of acquisitions for average calculation is defined with N-single/Avg count . If the waveform is clipped, the instrument shows a distorted average waveform to indicate the clipping. Adjust the vertical scale to avoid the clipping. The acquisition progress is shown in the acquisition label, see "Progress information" on page 66.

Remote command:

[ACQUIRE:TYPE](#) on page 475

Current Average count

Shows the current number of acquired waveforms that contribute to the average, for [Acquisition mode](#) = "Average".

Remote command:

[ACQUIRE:AVERAGE?](#) on page 471

Interpolation

Selects the interpolation method.

If the defined sample rate ("Sample rate", "Min. sample rate") is higher than the ADC sample rate, interpolation adds points between the captured samples of the waveform by various mathematic methods. The selected interpolation method is also used for zooming.

"Linear"	Two adjacent ADC sample points are connected by a straight line, the interpolated points are located on the line. You see a polygonal waveform similar to the real signal, and also the ADC sample points as vertexes.
"sin (x)/x"	Two adjacent ADC sample points are connected by a sin(x)/x curve, and also the adjoining sample points are considered by this curve. The interpolated points are located on the resulting curve. This interpolation method is precise and shows the best signal curve.
"Sample/Hold"	The ADC sample points are displayed like a histogram. For each sample interval, the voltage is taken from the sample point and considered as constant, and the intervals are connected with vertical lines. Thus, you see the discrete values of the ADC - the measured samples.

Remote command:

[ACquire:INTerpolate](#) on page 472

6.2.3 Segmentation settings

Access: "Menu" > "Acquisition" > "Segmented" tab.

You can acquire a limited number of segments, or the maximum number.

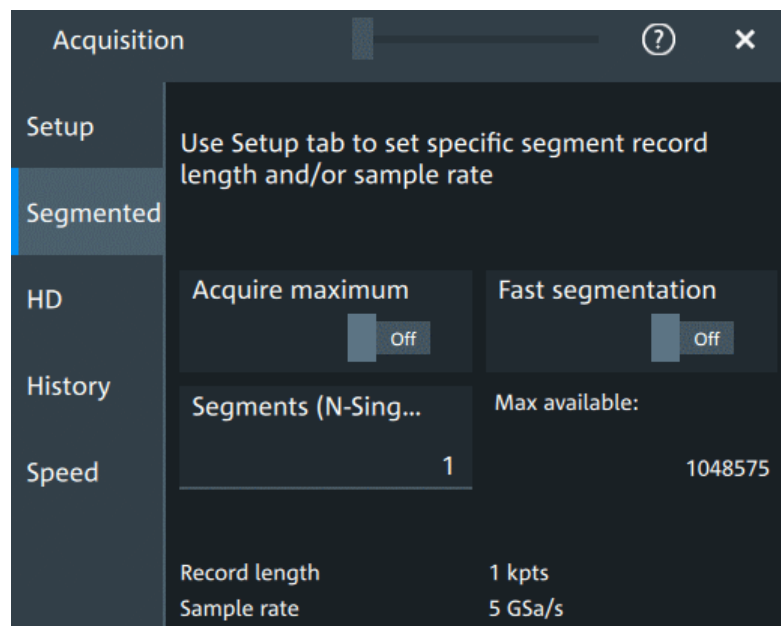

Acquire maximum

The setting takes effect for N-single acquisitions ([Single]). During continuous acquisition ([Run / Stop]), the history is used completely.

If "On", "Segments (N-Single)" is set to the maximum number of available segments, which is shown in "Max available". Thus, the history is filled completely with an N-single acquisition. "Segments (N-Single)" is read-only, you cannot change the value.

If "Off", set the number of segments in "Segments (N-Single)", which is the same setting as "N-single/Avg count" on the "Setup" tab. Thus you can acquire a fast segmentation acquisition series and history of defined length with [Single].

You can stop the running acquisition before the series is completed.

The number of acquired waveforms is shown in the "History" dialog, when the history is active.

Remote command:

[ACQUIRE:SEGMENTED:MAX](#) on page 476

Fast segmentation

If fast segmentation is enabled, the acquisitions are performed as fast as possible, without processing and displaying the waveforms. When acquisition has been stopped, the data is processed and the latest waveform is displayed. Older waveforms are stored in segments. You can display and analyze the segments using the history.

Remote command:

[ACQUIRE:SEGMENTED:STATE](#) on page 476

Segments (N-Single)

See "N-single/Avg count" on page 108.

Max available

Shows the maximum number of segments that can be captured with current sample rate and record length settings.

6.2.4 High definition mode

The high definition mode increases the numeric resolution of the waveform signal by using digital filtering, leading to reduced noise. The higher vertical resolution reduces quantization noise and acquires waveforms of higher accuracy with finer details of the signal to be seen. The high definition is also applied to the digital trigger, thus the R&S MXO 5 can trigger with the same high resolution with which they can display signals.

The maximum numeric resolution in high definition mode is 18 bit. The actual value depends on the selected bandwidth. Increasing the bandwidth reduces the resulting digital resolution. For dependencies and details, refer to the R&S MXO 5 specifications.

The number of vertical resolution bits defines the number of vertical levels that the acquisition samples are mapped to (quantization). For example, 16 bits of resolution represent 65536 voltage quantization levels, while 8 bits of resolution represent only 256 voltage levels. The waveform values are recorded with a word length of 16 bit, except for peak detect decimation.

6.2.4.1 High definition settings

Access: [HD]

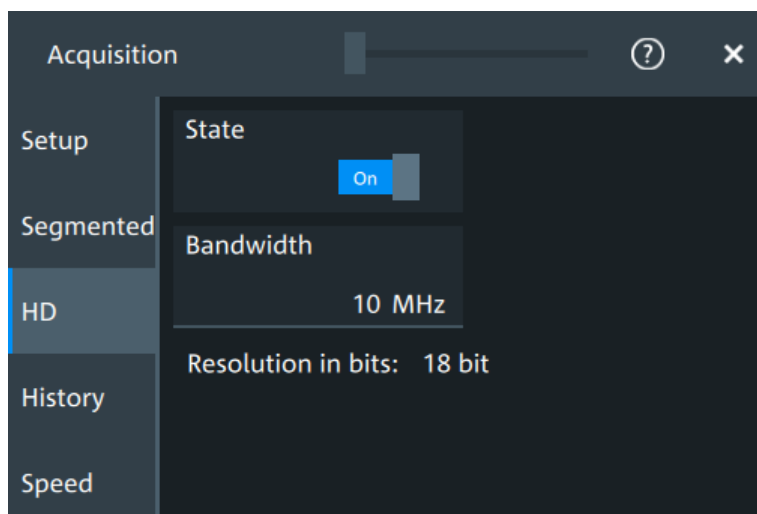

High definition is a special acquisition mode of the oscilloscope. This mode has only one setting - the filter bandwidth.

State

Enables high definition mode, which increases the numeric resolution of the waveform signal.

Remote command:

[HDEFinition:STATE](#) on page 491

Bandwidth

Sets the filter bandwidth for the high definition mode.

Increasing the bandwidth reduces the resulting digital resolution. For dependencies and details, refer to R&S MXO 5 specifications.

Remote command:

[HDEFinition:BWIDth](#) on page 491

Resolution in bits

Displays the resulting vertical resolution in high definition mode. The higher the filter bandwidth, the lower the resolution.

Remote command:

[HDEFinition:RESolution?](#) on page 491

6.2.5 History settings

The history settings are described in [Chapter 8.3.2, "History setup"](#), on page 171.

6.2.6 Speed

Access: "Menu" > "Acquisition" > "Speed" tab.

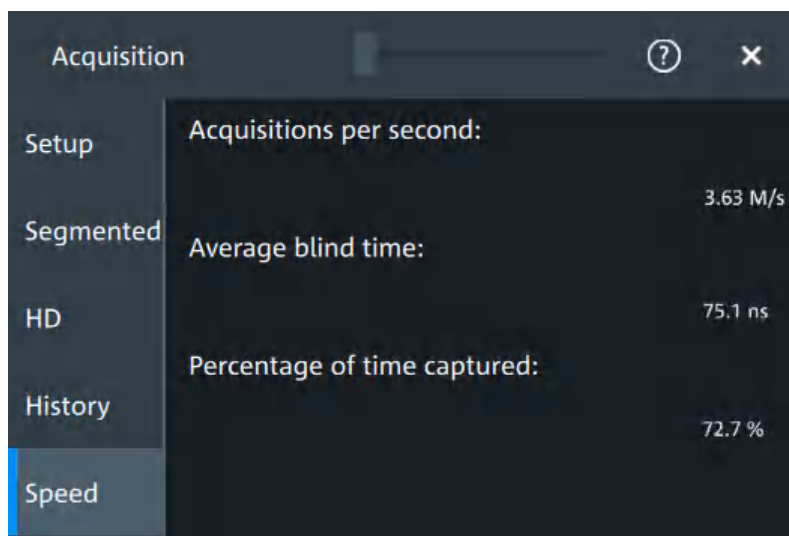

The "Speed" dialog shows information on the current acquisition performance values of the R&S MXO 5.

You can see the number of "Acquisitions per second", "Average blind time" and the "Percentage of time captured".

6.3 Vertical setup

The controls and parameters of the vertical system adjust the vertical scale and position of the waveform, and the waveform display. The probe settings also belong to the vertical setup.

The signal icons at the bottom of the display show the most important actual settings for each channel. The signal icon also indicates if the incoming data is clipped before processing, i.e. the input range of the ADC is exceeded.

There are several ways to adjust vertical settings:

- Use the keys and knobs in the Vertical functional block of the front panel to select the channel, to scale the waveform, and to set the position or offset. See [Chapter 3.2.4.4, "Vertical controls"](#), on page 37.
- Drag one finger vertically on the screen to change the position of the selected channel waveform.
- Spread or pinch two fingers in vertical direction to change the vertical scale of the selected waveform.
- Use the "Vertical" dialog to adjust all vertical settings. See:
 - [Chapter 6.3.2, "Vertical Setup settings"](#), on page 114
 - [Chapter 6.3.3, "Bandwidth settings"](#), on page 117
 - [Chapter 6.4, "Probes"](#), on page 119
 - [Chapter 6.3.5, "Other vertical settings"](#), on page 118

6.3.1 About the vertical system

The controls and parameters of the vertical system are used to scale and position the waveform vertically.

Vertical scale and resolution

Vertical scale and vertical position directly affect the resolution of the waveform amplitude. The vertical scale corresponds to the ADC input range. To get the full resolution of the ADC, set up the waveforms to cover most of the height of the diagram.

With an R&S MXO 5, you work with multiple diagrams, and each diagram obtains the full vertical resolution, no matter where the diagram is placed. Therefore, use a separate diagram for each waveform instead of the traditional setup that arranges the waveforms side by side in one diagram.

Bandwidth

For analog applications, the highest signal frequency determines the required oscilloscope bandwidth. The oscilloscope bandwidth should be higher than the maximum frequency included in the analog test signal to measure the amplitude with very little measurement error. To avoid aliasing, the oscilloscope bandwidth should be at least 3 times higher than the maximum frequency included in the signal.

Most test signals are more complex than a simple sine wave and include several spectral components. A digital signal, for example, is built up of several odd harmonics. For digital signals, the oscilloscope bandwidth should be at least 5 times higher than the clock frequency to be measured.

The oscilloscope is not a stand-alone system. You need a probe to measure the signal of interest, and the probe has a limited bandwidth, too. The combination of oscilloscope and probe creates a system bandwidth. To reduce the effect of the probe on the system bandwidth, the probe bandwidth should exceed the bandwidth of the oscilloscope, the recommended factor is 1.5 x oscilloscope bandwidth.

6.3.2 Vertical Setup settings

Access: "Menu" > "Vertical" > "Setup" tab

The "Setup" tab provides all basic vertical settings. The channels are listed in horizontal subtabs. Make sure to select the correct channel tab before you enter the settings.

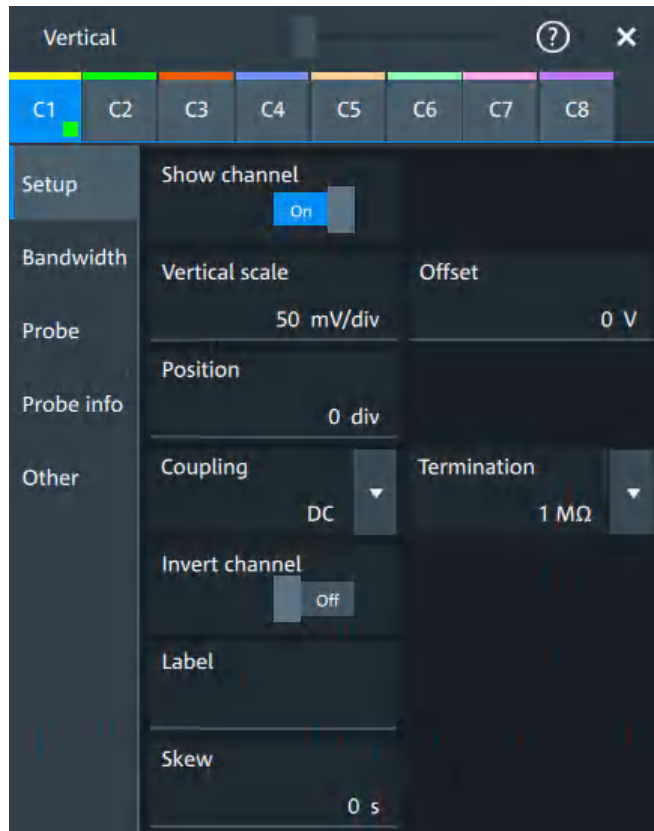

Show channel

Switches the selected channel signal on or off.

The signal icon opens on the signal bar. The waveform of the last acquisition is displayed in the diagram.

Remote command:

[CHANnel<ch>:STATe](#) on page 464

Vertical scale

Sets the vertical scale, which defines the displayed amplitude of the selected waveform.

The unit depends on the connected probe.

The current value is shown in the signal icon. Vertical scale directly affects the resolution of the waveform amplitude. To get the best resolution of the ADC, set the waveforms to cover most of the height of the diagram.

Remote command:

[CHANnel<ch>:SCALe](#) on page 465

Offset

Sets the offset voltage, which corrects an offset-affected signal. The vertical center of the selected channel is shifted by the offset value and the signal is repositioned within the diagram.

To set the offset automatically, use [Autoset]. The current value is shown in the signal icon.

Use the offset to measure small AC voltages that are overlaid by higher DC voltages. Unlike AC coupling, the DC part of the signal is not lost with offset setting.

If an active probe is connected, the offset limit is defined by the probe. Refer to the documentation of the probe for allowed values.

If a Rohde & Schwarz differential probe is connected, set the common-mode offset to compensate for a common DC voltage applied to both input sockets (referenced to the ground socket). Thus, you can measure on differential signals with high common mode levels. You can measure the common mode input voltage using the R&S ProbeMeter.

Remote command:

[CHANnel<ch>:OFFSet](#) on page 465

Position

Moves the selected signal up or down in the diagram. While the offset sets a voltage, position is a graphical setting given in divisions. The visual effect is the same as for offset.

Remote command:

[CHANnel<ch>:POSition](#) on page 466

Coupling

Sets the filter for the input signal. The coupling determines what part of the signal is used for waveform analysis and triggering.

The selected coupling is shown in the signal icon.

"DC" Passes both DC and AC components of the signal.

"AC" Connection through DC capacitor, removes DC and very low-frequency components. AC coupling is useful if the DC component of a signal is of no interest. The waveform is centered on zero volts.

If AC coupling is set, the attenuation of passive probes has no effect, and voltage is applied to the instrument with factor 1:1. Observe the voltage limits, otherwise you can damage the instrument.

Remote command:

[CHANnel<ch>:COUpling](#) on page 466

Termination

Selects the input impedance of the channel input according to the connected probe.

Connection with 50 Ω termination is used to connect, for example, active probes. Connection with 1 M Ω termination is used to connect standard passive probes.

Remote command:

[CHANnel<ch>:COUpling](#) on page 466

Invert channel

Turns the inversion of the signal amplitude on or off. To invert means to reflect the voltage values of all signal components against the ground level.

Inversion is indicated in the signal icon by line above the channel name.

Remote command:

`CHANnel<ch>:INVert` on page 467

Label

Defines a label text. The label is shown at the waveform on the right edge of the display.

Skew

Sets a skew value to compensate for the delay of the measurement setup or from the circuit specifics that the instrument cannot compensate automatically. It affects only the selected input channel.

Delay differences between channels are caused by the different length of cables, probes, and other sources. Correct deskew values are important for accurate triggering. Signals that are routed over lines with different lengths have a different propagation delay. This delay can lead to a non-synchronous waveform display.

Remote command:

`CHANnel<ch>:SKEW:TIME` on page 467

6.3.3 Bandwidth settings

Access: "Menu" > "Vertical" > "Bandwidth" tab

The "Bandwidth" tab provides all settings that affect the bandwidth of the measurement system. The channels are listed in horizontal subtabs. Make sure to select the correct channel tab before you enter the settings.



Bandwidth

Sets the bandwidth limit. The specified bandwidth indicates the range of frequencies that the instrument can acquire and display accurately with less than 3 dB attenuation. Frequencies above the limit are removed from the signal, and noise is reduced.

The selected bandwidth is shown on the signal icon.

For basic information, see also: "[Bandwidth](#)" on page 114.

"Full" At full bandwidth, all frequencies in the instrument's frequency range are acquired and displayed. Full bandwidth is used for most applications. However, at full bandwidth, the displayed bandwidth can be less than the instrument bandwidth depending on the number of active channels and other settings.

"xx MHz" Frequencies above the selected limit are removed to reduce noise.

Remote command:

`CHANnel<ch>:BANDwidth` on page 468

Probe type, Probe bandwidth

Shows the type of the connected probe and its bandwidth. The probe is recognized automatically, or selected in the "Probe" tab. See [Chapter 6.4.1, "Common probe settings"](#), on page 119.

Effective bandwidth

Shows the effective bandwidth of probe and oscilloscope system.

6.3.4 Probe settings

See [Chapter 6.4, "Probes"](#), on page 119.

6.3.5 Other vertical settings

Access: "Menu" > "Vertical" > "Other" tab

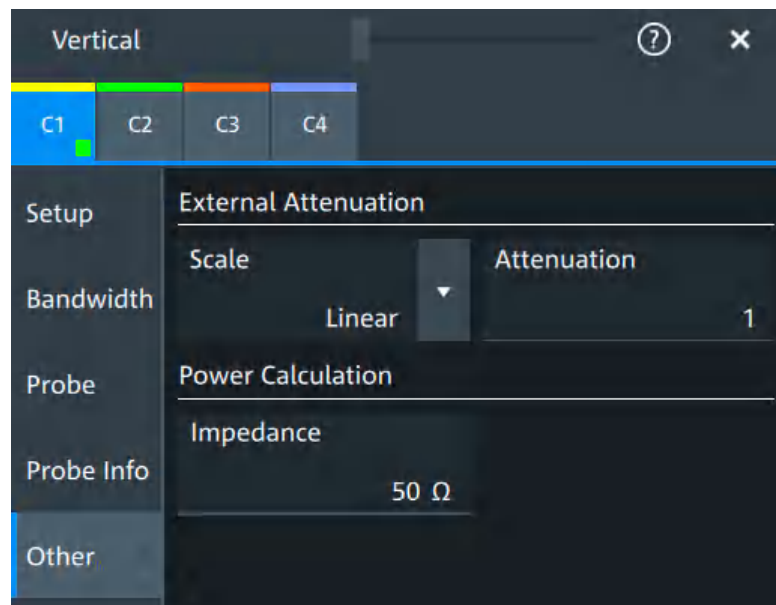

External Attenuation: Scale, Attenuation

Consider a voltage divider that is part of the DUT before the measuring point. The external attenuation is included in the measurement, and the instrument shows the results that would be measured before the divider. External attenuation can be used with all probes.

"Scale"	Select linear or logarithmic attenuation scale.
"Attenuation"	Enter the attenuation of the voltage divider according to the selected scale. The conversion from linear to logarithmic values depends on the "Vertical unit" of the probe: For voltage-based unit (V and A): $attenuation (dB) = 20 * \log_{10}(attenuation\ factor)$ For power-based unit (W): $attenuation (dB) = 10 * \log_{10}(attenuation\ factor)$

Remote command:

[CHANnel<ch>:EATScale](#) on page 468

[CHANnel<ch>:EATTenuation](#) on page 468

Impedance

Sets the impedance of the connected probe for power calculations and measurements.

The value is used, for example, for scale calculation in the spectrum diagram.

Remote command:

[CHANnel<ch>:IMPedance](#) on page 469

6.4 Probes

With R&S MXO 5 oscilloscopes, you can use various probe types. Mostly these probes are passive and active voltage probes. The instrument can detect many probes and read out the probe-specific parameters, for example, bandwidth and attenuation.

You find all settings that are relevant for the connected probe in the "Vertical" > "Probe" tab. The settings on the "Probe" tab change according to the type of the attached probe. Probes with Rohde & Schwarz probe interface (probe box), and also many other passive voltage probes, are recognized by the instrument. The R&S MXO 5 reads out the main characteristics of the probe and displays them. Other probes cannot be detected, but their characteristics are known to the instrument. These known probes are called "Predefined probes". Probes that are not recognized automatically and not predefined are unknown probes, they require manual setting of measurement unit and attenuation.

The complete characteristic of the connected probe is shown on the "Vertical" > "Probe Info" tab.

6.4.1 Common probe settings

Access: "Menu" > "Vertical" > "Probe" tab

Most the settings in the "Probe" tab are available for all probes. For some probe types, additional settings are needed. These settings are described in the sections for the individual probe types.

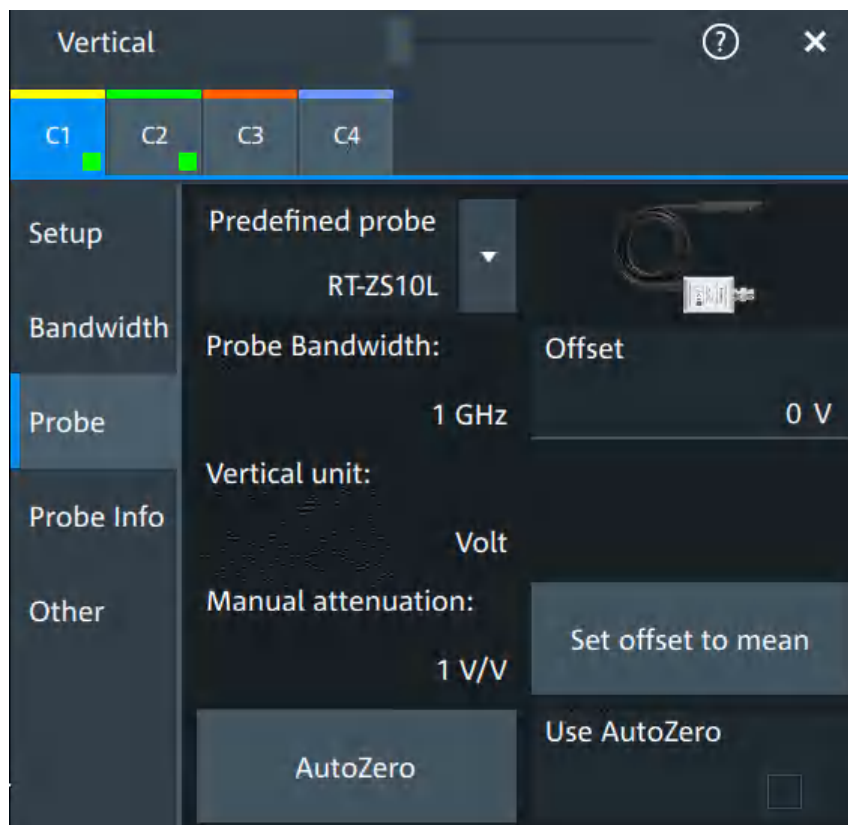

An external attenuation can be set on the "Other" tab, see [Chapter 6.3.5, "Other vertical settings"](#), on page 118.

The common probe settings are:

Predefined probe, name and type of the probe	120
Probe bandwidth	121
Offset	121
Vertical unit	121
Manual attenuation	121
Set offset to mean	121
AutoZero, Use AutoZero	122

Predefined probe, name and type of the probe

The model name and type of a detected probe are shown in the dialog.

If the instrument cannot recognize the probe, "None" is indicated in the "Predefined probe" list. Select the used probe on the list. The corresponding bandwidth, and attenuation or gain are shown.

If the probe is not detected and not listed as predefined probe, it is an unknown probe. To configure these probes, set "Predefined probe" to "User-Defined". Then adjust the [Vertical unit](#) and [Manual attenuation](#).

Remote command:

[PROBe<ch>:SETup:NAME?](#) on page 480

[PROBe<ch>:SETup:TYPE?](#) on page 480

[PROBe<ch>:SETup:STATe?](#) on page 480

[PROBe<ch>:SETup:ATTenuation:DEFProbe](#) on page 477

Probe bandwidth

Shows the bandwidth of the connected probe. For probes that are not detected or predefined, set the bandwidth manually.

Remote command:

[PROBe<ch>:SETup:BANDwidth?](#) on page 478

Offset

Channel offset that is also set on "Vertical" > "Setup" tab. See "Offset" on page 115.

Vertical unit

Shows the unit of the connected probe if the probe is detected or predefined. For unknown probes, select the unit that the probe can measure.

Remote command:

[PROBe<ch>:SETup:ATTenuation:UNIT](#) on page 478

Manual attenuation

Shows the attenuation of the connected probe if the probe is detected or predefined. For unknown probes, set the correct attenuation of the probe.

The vertical scaling and measured values are multiplied by this factor so that the displayed values are equal to the actual measured signal values.

Make sure to set the attenuation factor on the instrument according to the probe being used. Otherwise, the measurement results do not reflect the actual voltage level, and you might misjudge the actual risk.

Remote command:

[PROBe<ch>:SETup:ATTenuation\[:AUTO\]?](#) on page 477

[PROBe<ch>:SETup:ATTenuation:MANual](#) on page 477

Set offset to mean

Compensates automatically for a DC component of the input signal using the result of a background mean measurement.

The result is shown in "Offset". The function is probe-independent and supports quick and convenient measurements of input signals with different DC offsets. It detects offset values even when the signal is out of the current measurement range. It also sets the zero level to the determined DC offset in the middle of the screen and thus prevents clipping of the waveform.

Remote command:

[PROBe<ch>:SETup:OFFSet:TOMean](#) on page 479

AutoZero, Use AutoZero

Differences in DUT and oscilloscope ground levels can cause larger zero errors, which affect the waveform. If the DUT is ground-referenced, the AutoZero function corrects the zero error of the probe to optimize measurement results at small signal levels. The validation limit depends on the probe attenuation because probes with high attenuation often have to compensate high offsets. AutoZero detects offset values even when the signal is out of the current measurement range.

To correct the zero error of voltage probes, short the signal pin and the ground pin together and connect them to the ground of the DUT. Then tap "AutoZero". While the alignment is running, the instrument switches to DC coupling to display the waveform correctly.

To include the measured offset in measurement results, enable "Use AutoZero".

If a current probe is connected, the function demagnetizes the probe's sensor head and sets the waveform to zero position.

Remote command:

[PROBe<ch>:SETup:OFFSet:AZERo](#) on page 479

[PROBe<ch>:SETup:OFFSet:USEautozero](#) on page 479

6.4.2 Setup for passive probes

Passive probes are the most widely used probes for voltage measurements with oscilloscopes. If a passive probe is connected, the probe attenuation is read out and shown in the "Probe" tab.

Passive probes require compensation, see [Chapter 6.4.6, "Adjusting passive probes"](#), on page 132.

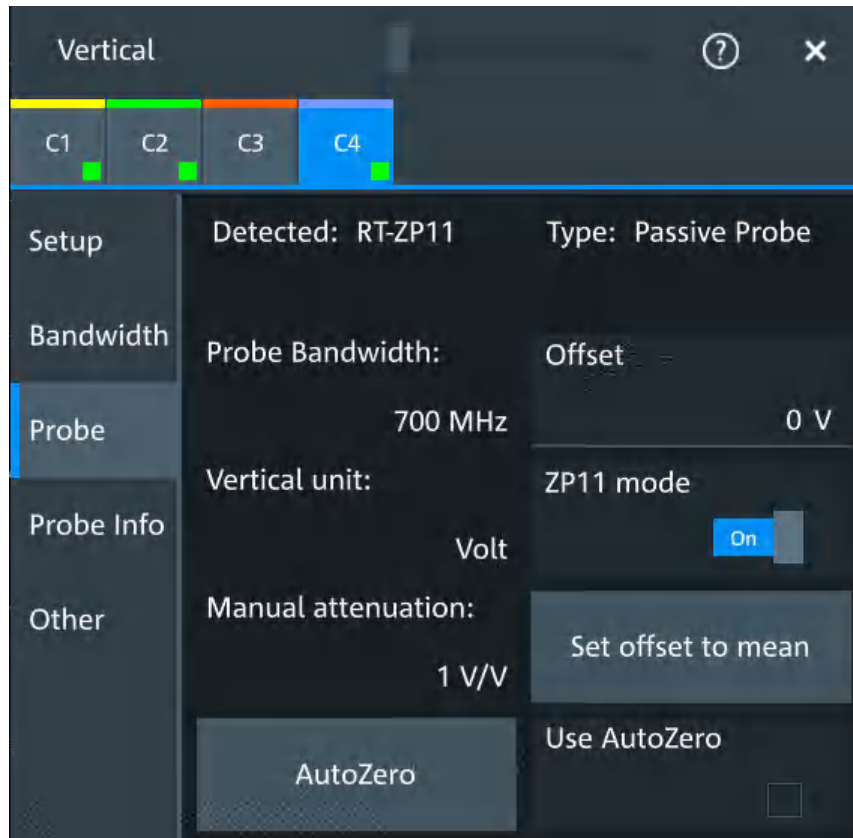

Figure 6-3: Passive probe R&S RT-ZP11, detected by the oscilloscope

The settings for passive probes are common settings, which are available for all probe types. See [Chapter 6.4.1, "Common probe settings"](#), on page 119 for description of the settings.

For R&S RT-ZP11, a special setting is available.

ZP11 mode

Enable if R&S RT-ZP11 is connected to adjust the probe bandwidth to 700 MHz.

If you use 500 MHz passive probe, e.g. R&S RT-ZP10, disable the setting.

6.4.3 Setup for active voltage probes

Active voltage probes with Rohde & Schwarz probe interface have an integrated data memory that contains identification data and individual probe correction parameters. The R&S MXO 5 can detect these probes and read out the data. Furthermore, the Rohde & Schwarz probe interface provides special features: the micro button and the ProbeMeter.

Active voltage probes that are offered by Rohde & Schwarz but not equipped with a Rohde & Schwarz probe interface are known to the R&S MXO 5 as predefined probes.

6.4.3.1 Settings for the Rohde & Schwarz probe interface

The Rohde & Schwarz probe interface provides special features: the micro button and the ProbeMeter.

MicroButton

The micro button is located on the probe head. Pressing this button, you initiate an action on the instrument directly from the probe. The button is disabled during internal automatic processes, for example, during self-alignment, autoset, and level detection. Select the action that you want to start from the probe.

"Run Continuous"	Starts or stops the acquisition (same as Run / Stop key).
"Run single"	Starts a defined number of acquisitions (same as [Single] key).
"Auto set"	Starts the autoset procedure (same as Autoset key).
"AutoZero"	Starts an auto zero measurement.
"Set offset to mean"	Performs an automatic compensation for a DC component of the input signal using the result of a background mean measurement.
"Save image to file"	Saves the current display as image according to the image settings.
"No action"	Select this option to prevent unwanted actions due to unintended usage of the micro button.
"Find trigger level"	Sets the trigger level automatically to $0.5 * (MaxPeak - MinPeak)$.
"Probe Setup"	Opens the probe setup on the screen.

Remote command:

[PROBe<ch>:SETup:MODE](#) on page 481

ProbeMeter

Activates the integrated R&S ProbeMeter on probes with Rohde & Schwarz probe interface.

The R&S ProbeMeter is a voltmeter. It measures DC voltages between the probe tip and ground connection or between the probe tips with very high precision. The measurement runs continuously and in parallel to the measurements of the oscilloscope.

If a single-ended or power rail probe is connected, the ProbeMeter measures DC voltages between the probe tip and ground connection and enables ground-referenced measurements of voltages.

If a differential probe is connected, you can select if the ProbeMeter measures differential and common mode voltages, or single-ended voltages. See "[Display](#)" on page 126.

Remote command:

[PROBe<ch>:PMETer:STATe](#) on page 483

[PROBe<ch>:PMETer:RESults:SINGLE?](#) on page 484

[PROBe<ch>:PMETer:RESults:COMMON?](#) on page 484

[PROBe<ch>:PMETer:RESults:DIFFerential?](#) on page 484

[PROBe<ch>:PMETer:RESults:NEGative?](#) on page 485

[PROBe<ch>:PMETer:RESults:POSitive?](#) on page 485

6.4.3.2 Setup for R&S RT-ZD differential probes

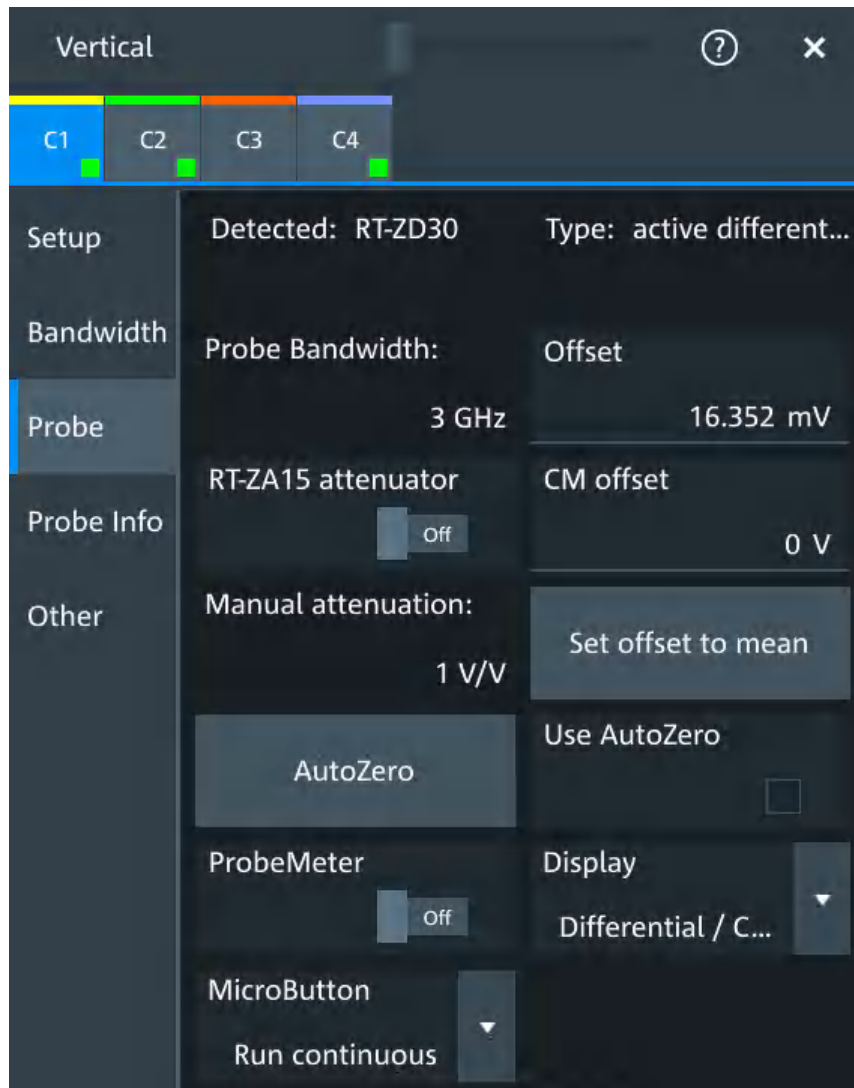

Figure 6-4: Probe setup for active differential probe R&S RT-ZD30

Most settings are common settings, which are available for all probe types. See [Chapter 6.4.1, "Common probe settings"](#), on page 119 for description of these settings.

R&S RT-ZD differential probes have the Rohde & Schwarz probe interface and support its functions. For details, see [Chapter 6.4.3.1, "Settings for the Rohde & Schwarz probe interface"](#), on page 124.

The "Offset" is the differential offset, see ["Offset"](#) on page 115.

Specific settings for R&S RT-ZD probes are the following:

CM offset

Sets the common-mode offset to compensate for a common DC voltage that is applied to both input sockets (referenced to the ground socket). The setting is available for Rohde & Schwarz differential probes.

Offset compensation is particularly helpful for measurements on differential signals with high common mode levels, for example, current measurements using a shunt resistor. You can measure the common mode input voltage using the R&S ProbeMeter.

Remote command:

`PROBe<ch>:SETup:CMOffset` on page 482

RT-ZA15 attenuator

If you use the external attenuator R&S RT-ZA15 together with one of the differential active probes R&S RT-ZD10/20/30, enable "RT-ZA15 attenuator" to include the external attenuation in the measurements.

Remote command:

`PROBe<ch>:SETup:ZAXV` on page 483

Display

Selects the voltage to be measured by the ProbeMeter of differential active probes:

- "Differential / Common Mode":
Differential voltage is the voltage between the positive and negative signal sockets. Common mode voltage is the mean voltage between the signal sockets and the ground socket. It measures the voltage level relative to ground, for example, to check the operating voltage window.
- "Single Ended Pos/Neg":
Measures the voltage between the positive/negative signal socket and the ground. The ProbeMeter always measures the common mode and differential voltages. Single-ended voltages are calculated values:
$$V_p = V_{cm} + 0.5 * V_{in} \text{ and } V_n = V_{cm} - 0.5 * V_{in}$$

Remote command:

`PROBe<ch>:SETup:DISPlaydiff` on page 483

6.4.3.3 Setup for R&S RT-ZPR power rail probes

R&S RT-ZPR power rail probes are designed for power integrity measurements. They can measure small signals in the millivolt range with large DC-offset components.

R&S RT-ZPR power rail probes have the Rohde & Schwarz probe interface and support the ProbeMeter, but not the micro button. For details, see [Chapter 6.4.3.1, "Settings for the Rohde & Schwarz probe interface"](#), on page 124.

R&S RT-ZPR probes require 50 Ω input termination.

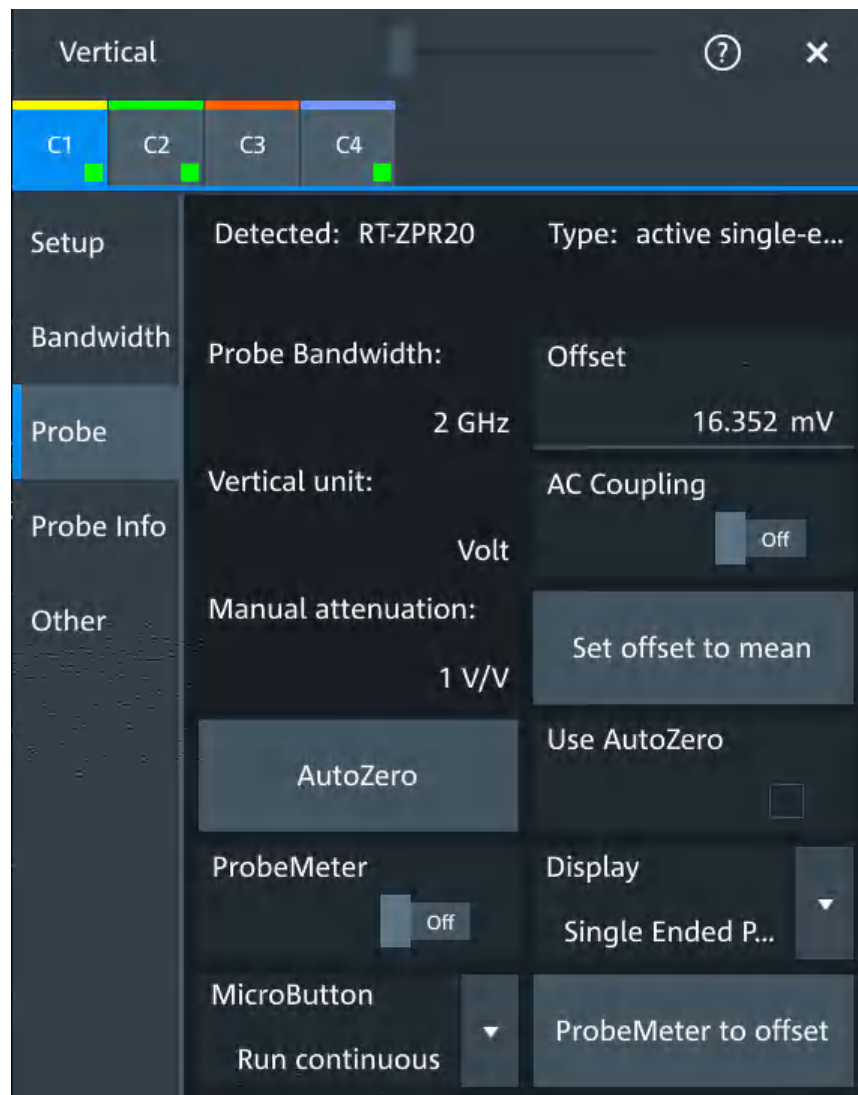

Figure 6-5: Probe setup for power rail probe R&S RT-ZPR20

Most settings are common settings, which are available for all probe types. See [Chapter 6.4.1, "Common probe settings"](#), on page 119 for description of these settings.

The "Offset" is the channel offset, see ["Offset"](#) on page 115.

Specific settings for R&S RT-ZPR probe are the following:

AC Coupling

Enables AC coupling in R&S RT-ZPR power rail probes, which removes DC and very low-frequency components. The R&S RT-ZPR probe requires 50 Ω input termination, for which the channel AC coupling is not available. The probe setting allows AC coupling also at 50 Ω inputs.

Remote command:

`PROBe<ch>:SETup:ACCoupling` on page 482

ProbeMeter to offset

Sets the measured ProbeMeter value as offset. Thus, the value is considered in measurements.

Remote command:

`PROBe<ch>:SETup:ADVanced:PMToffset` on page 487

6.4.3.4 Setup for R&S RT-ZHD high-voltage differential probes

R&S RT-ZHD high-voltage differential probes are designed to measure safely high-voltage floating circuits using a grounded oscilloscope. They extend the measurement capability of oscilloscopes to measure electronic power converters, inverters, motor speed controls, switch mode power supplies and many other applications.

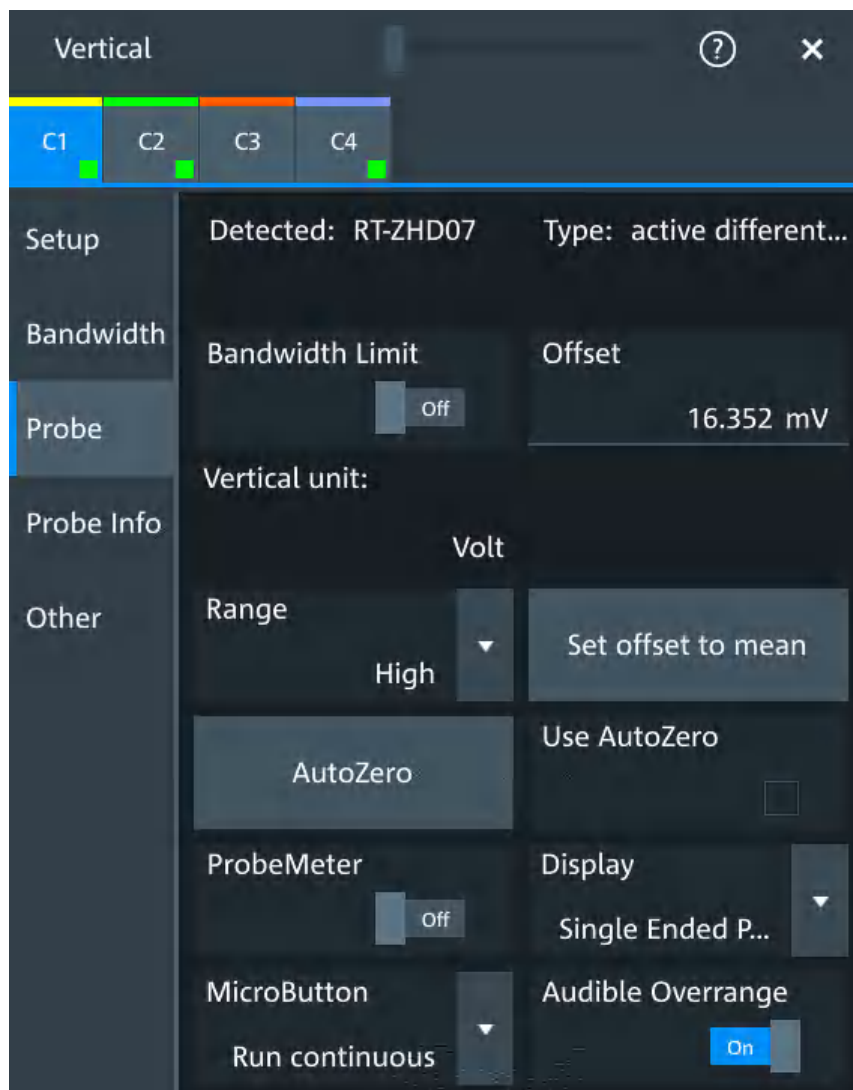

Figure 6-6: Setup for high-voltage differential probe R&S RT-ZHD07

Most settings are common settings, which are available for all probe types. See [Chapter 6.4.1, "Common probe settings"](#), on page 119 for description of these settings.

Bandwidth and attenuation values are indicated on the probe control box. The "Offset" is the differential offset, see ["Offset"](#) on page 115.

R&S RT-ZHD high-voltage differential probes have the Rohde & Schwarz probe interface and support its functions. For details, see [Chapter 6.4.3.1, "Settings for the Rohde & Schwarz probe interface"](#), on page 124.

Specific settings for R&S RT-ZHD probes are the following:

Bandwidth limit

Activates the lowpass filter in the probe control box. The filter frequency depends on the probe type and is indicated on the probe control box.

You can set the filter on the probe control box or at the oscilloscope.

Remote command:

[PROBe<ch>:SETup:ADVanced:FILTer](#) on page 486

Range

Sets the voltage range of an R&S RT-ZHD probe. You can set the range on the probe control box or at the oscilloscope.

"Auto"	The voltage range is set only at the oscilloscope with "Vertical scale".
"Low"	Sets the lower voltage range of the connected probe. The range values depend on the probe type and are indicated on the probe control box.
"High"	Sets the higher voltage range of the connected probe. The range values depend on the probe type and are indicated on the probe control box.

Remote command:

[PROBe<ch>:SETup:ADVanced:RANGe](#) on page 486

Audible overrange

Activates the acoustic overrange warning in the probe control box. You can also activate the sound directly on the probe control box.

Remote command:

[PROBe<ch>:SETup:ADVanced:AUDioverload](#) on page 486

6.4.4 Setup for current probes

The setup and adjustment of current probes depends on the output connector of the probe: BNC or Rohde & Schwarz probe box.

Current probes R&S RT-ZCxx

The current probes **R&S RT-ZCxx** have BNC connectors. They are known to the R&S MXO 5 as predefined probes, see ["Predefined probe, name and type of the probe"](#) on page 120. Demagnetizing and zero adjustment is done on the probe, see the probe's User Manual for details. Make sure to demagnetize and adjust the probe before taking measurements.

Current probes R&S RT-ZCxxB

Current probes **R&S RT-ZCxxB** have a Rohde & Schwarz probe interface; they are powered and remotely controlled by the oscilloscope.

When the probe is connected, demagnetization is performed automatically.

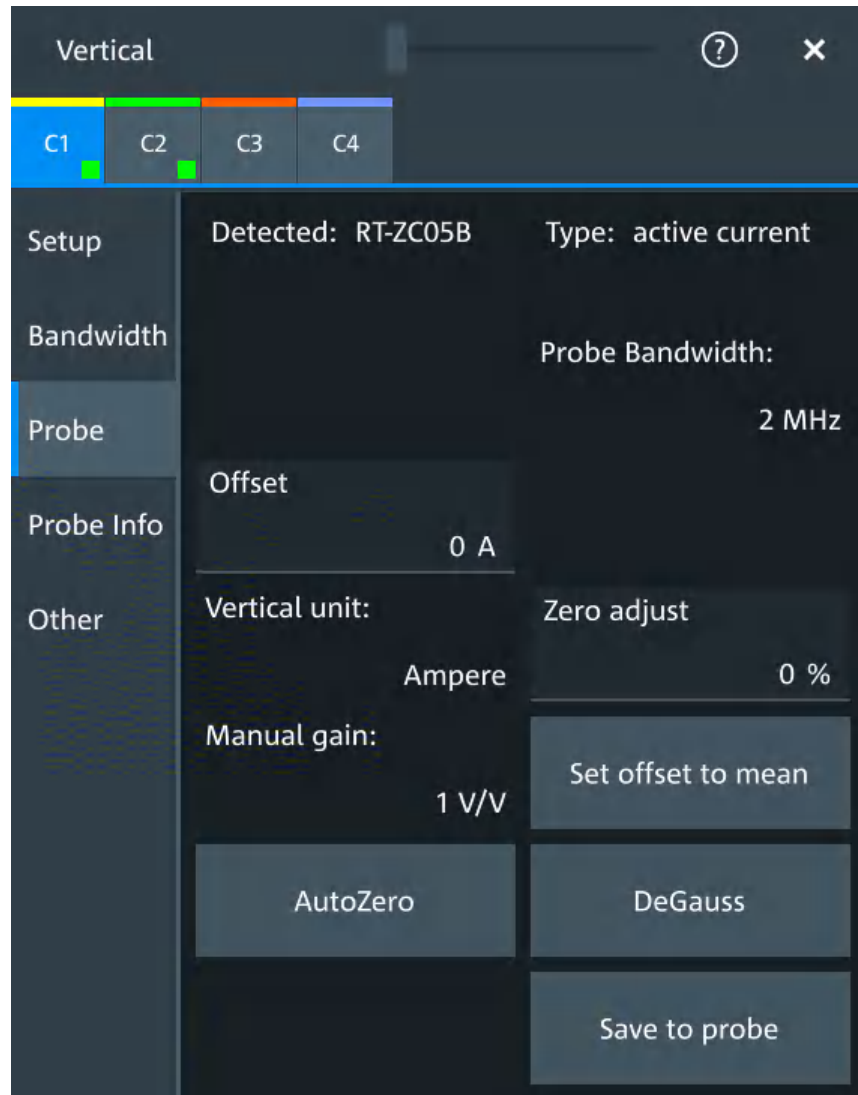

Figure 6-7: Setup for current probe R&S RT-ZC05B

Most settings are common settings, which are available for all probe types. See [Chapter 6.4.1, "Common probe settings"](#), on page 119 for description of these settings.

Current probes are adjusted by the following functions.

Gain, Manual gain

Shows the gain of the connected probe if the probe is detected or predefined. For unknown current probes, set the correct gain of the probe.

The vertical scaling and measured values are multiplied by this factor so that the displayed values are equal to the actual measured signal values.

Remote command:

[PROBe<ch>:SETup:GAIN:AUTO?](#) on page 487

[PROBe<ch>:SETup:GAIN:MANual](#) on page 487

DeGauss

Demagnetizes the core if it has been magnetized by switching the power on and off, or by an excessive input. Always carry out demagnetizing before measurement.

The demagnetizing process takes about one second. During demagnetizing, a demagnetizing waveform is displayed.

Demagnetizing is done automatically when R&S RT-ZCxxB is connected to the oscilloscope, or when "AutoZero" is performed.

Remote command:

[PROBe<ch>:SETup:DEGauss](#) on page 488

Zero adjust

Zero adjust corrects the effect of an offset caused by temperature drift, and compensates for the remanence. The setting is only available if DC coupling is set.

To set the waveform to zero level by the instrument, use "AutoZero". The detected value is displayed.

Alternatively, you can adjust the value manually until the waveform is set to zero level. Make sure to demagnetize the probe before zero adjustment.

The value is given in percent of the maximum range, which is internally defined. The actual setup range depends on the temperature drift, the measured current and other variables, and it can change over time. If you measure high currents, the probe core magnetizes, which impairs the measurement results. Therefore, repeat "AutoZero" before the measurement.

Remote command:

[PROBe<ch>:SETup:OFFSet:ZADJust](#) on page 488

Save to probe

Saves the zero adjust value in the probe box. If you connect the probe to another channel or to another Rohde & Schwarz oscilloscope, the value is read out again, and you can use the probe without further adjustment.

Remote command:

[PROBe<ch>:SETup:OFFSet:STPRobe](#) on page 488

6.4.5 Probe info

The dialog shows general information on the connected probe, for example, type, serial number, and part number. Below, electrical characteristics are shown, like bandwidth, attenuation, input capacitance and impedance, voltage and DC offset range.

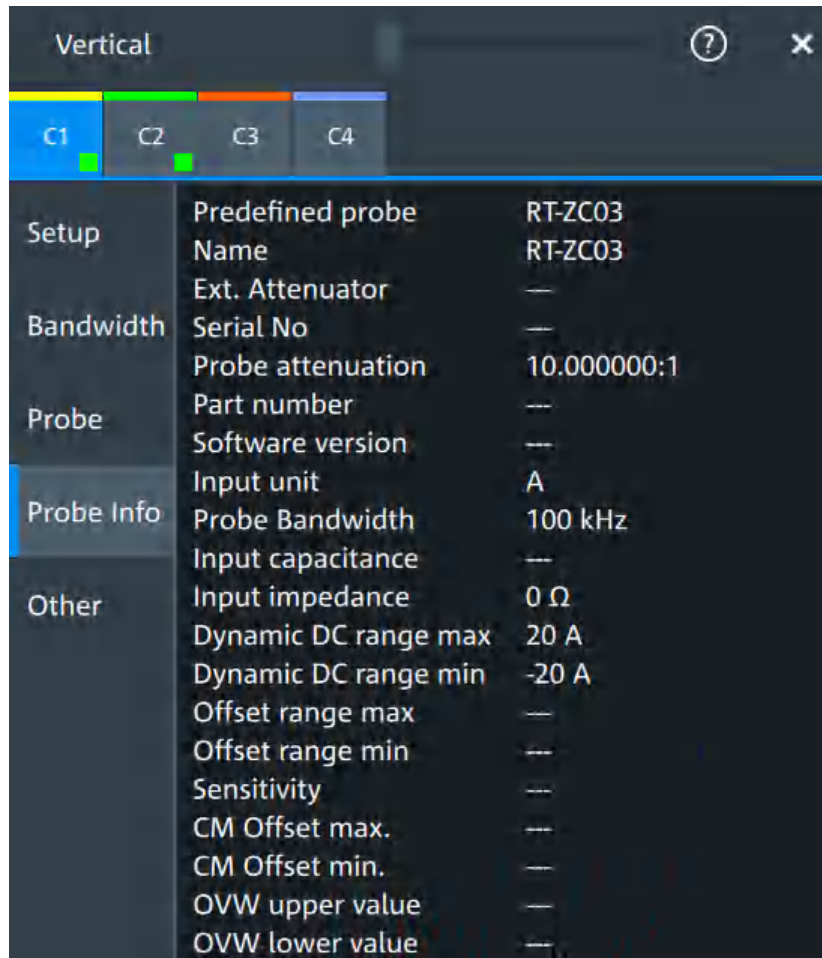

For a specification of the probe parameters, refer to the data sheet.



Remote commands: [Chapter 17.8.8.4, "Probe attributes"](#), on page 489.

6.4.6 Adjusting passive probes

When using a passive probe, you have to compensate it when you connect it to the instrument the first time. Compensation matches the probe cable capacitance to the oscilloscope input capacitance to assure good amplitude accuracy from DC to upper bandwidth limit frequencies. A poorly compensated probe reduces the performance of the probe-oscilloscope system and introduces measurement errors resulting in distorted waveforms and inaccurate results.

Two connector pins are located on the front panel. The  pin is on ground level. The  pin supplies a square wave signal with 1 kHz for low frequency probe compensation.

1. Connect the BNC connector of the probe to one of the channel inputs.
2. Connect the probe's ground connector to the ground compensation pin, and the probe tip to the signal pin.
3. Press [Autoset].

A square wave appears on the display.

4. Adjust the compensation trimmer of the probe to optimum square wave response.
For details, refer to the documentation of your probe.

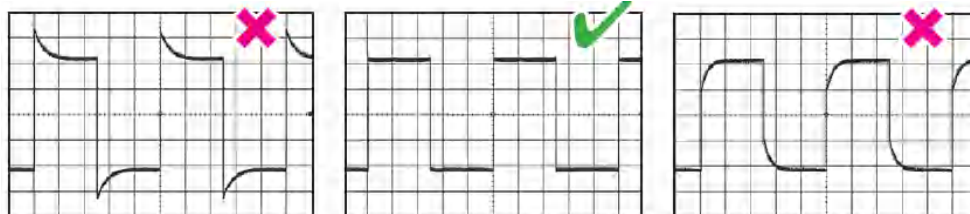

7 Trigger

• Basics of triggering.....	134
• Common trigger settings.....	135
• Trigger types.....	137
• Trigger mode / holdoff.....	152
• Hysteresis.....	155
• Channel filter.....	156
• Actions on trigger.....	157

7.1 Basics of triggering

Triggering means to capture the interesting part of the relevant waveforms, and the trigger point is the determining point in the waveform record. Choosing the right trigger type and configuring all trigger settings correctly allows you to detect various incidents in analog, digital, and protocol signals.

How the instrument triggers

A trigger occurs if the complete set of trigger conditions is fulfilled. The instrument acquires continuously and keeps the sample points to fill the pre-trigger part of the waveform record. When the trigger occurs, the instrument continues acquisition until the post-trigger part of the waveform record is filled. Then it stops acquiring and waits for the next trigger. When a trigger is recognized, the instrument does not accept another trigger until the acquisition is complete and the holdoff time has expired.

Trigger setup

A simple trigger setup includes:

- Source of the trigger signal
- Trigger type selection and setup
- Horizontal position of the trigger, see: [Chapter 6.1.1, "About the horizontal system"](#), on page 100
- Trigger mode

The R&S MXO 5 provides various trigger types for troubleshooting and signal analysis, for example, edge trigger, glitch trigger, interval trigger, and much more.

For complex tasks like verifying and debugging designs, advanced trigger settings are available:

- Filter to remove high or low frequencies from the trigger signal
- Hysteresis to avoid unwanted trigger events caused by noise
- Holdoff to define exactly which trigger event causes the trigger

Action on trigger

A trigger can initiate a trigger out signal.

7.1.1 Trigger information

Information on the most important trigger settings is shown in the trigger label above the diagram. If you tap the trigger label, the "Trigger" dialog opens.

If you trigger on a single event, the trigger label shows:

- Trigger source
- Trigger type
- Trigger level
- Trigger mode
- Edge or polarity, and important trigger-type specific settings
- Trigger state

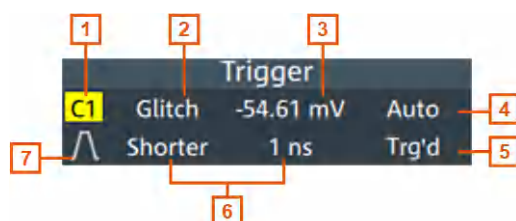

Figure 7-1: Trigger label on the toolbar

- 1 = Trigger source
- 2 = Trigger type
- 3 = Trigger level
- 4 = Trigger mode
- 5 = Trigger state
- 6 = Trigger type specific settings
- 7 = Trigger slope

7.2 Common trigger settings

Access: "Menu" > "Trigger" > "Setup" tab

The common trigger settings are the trigger source and the trigger type, including the trigger level. To set the trigger level automatically, use "Find level".

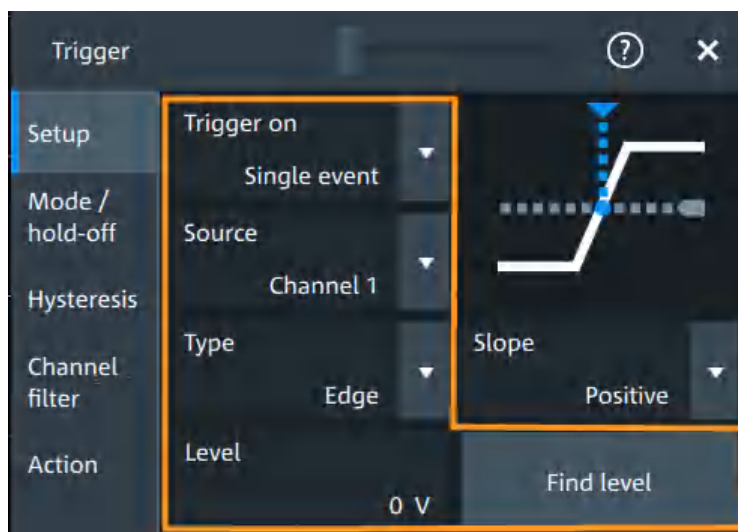

Depending on the trigger type, additional settings are available. They are explained in the trigger-type specific sections.

Trigger on.....	136
Source.....	136
Type.....	136
Level.....	137
Find level.....	137

Trigger on

Trigger on single event is the only supported mode.

Remote command:

[TRIGger:MEVents:MODE](#) on page 493

Source

Selects the source of the trigger signal for the selected trigger event. The trigger source works even if it is not displayed in a diagram.

All inputs can be used as trigger source.

The trigger source can be:

- Channel <n>: an analog input channel
- Extern: external analog signal connected to the external trigger input. For the external trigger source, the analog edge trigger is available.
- Line: The instrument generates the trigger from the AC power input and synchronizes the signal to the AC power frequency. Use this source if you want to analyze signals related to the power line frequency, such as lighting equipment and power supply devices. For the line trigger source, the edge trigger type is available.
- Digital channels D0 to D15, serial bus

Remote command:

[TRIGger:EVENT<ev>:SOURce](#) on page 494

Type

Selects the trigger type.

The current trigger type is shown on the button and in the trigger label above the diagram.

The following trigger types are available:

- [Edge trigger, see page 138](#)
- [Glitch trigger, see page 140](#)
- [Width trigger, see page 142](#)
- [Runt trigger, see page 143](#)
- [Window trigger, see page 145](#)
- [Timeout trigger, see page 147](#)
- [Interval trigger, see page 148](#)
- [Slew rate trigger, see page 150](#)

If the external trigger input is used as trigger source, the analog edge trigger is the only available trigger type.

For digital channels, the edge, width and timeout trigger are available.

Remote command:

[TRIGger:EVENT<ev>:TYPE](#) on page 493

Level

Sets the voltage level or threshold for the trigger.

You can also drag the trigger level marker on the display, or turn the [Level] knob. To set the trigger level to 50% of the signal amplitude, press the [Level] knob.

For the timeout trigger, the trigger level is the threshold for the high and low signal states.

Runt, window and slew rate triggers require two trigger levels (upper and lower), which are defined as specific settings.

Remote command:

[TRIGger:EVENT<ev>:LEVel<n>\[:VALue\]](#) on page 493

[TRIGger:ANEDge:LEVel](#) on page 495 (for external trigger source)

Find level

Sets the trigger level automatically to $0.5 * (MaxPeak - MinPeak)$.

The function is not available for trigger sources "Extern" and "Line".

Remote command:

[TRIGger:FINDlevel](#) on page 494

7.3 Trigger types

• Edge trigger	138
• Edge trigger on external trigger source	138
• Glitch trigger	140
• Width trigger	142
• Runt trigger	143
• Window trigger	145
• Timeout trigger	147

- [Interval trigger](#)..... 148
- [Slew rate trigger](#)..... 150
- [Line trigger](#)..... 152

7.3.1 Edge trigger

Access: "Menu" > "Trigger" > "Setup" tab > "Type = Edge"

The edge trigger is the most common trigger type. The trigger occurs when the signal from the trigger source passes the trigger level in the specified direction (slope).

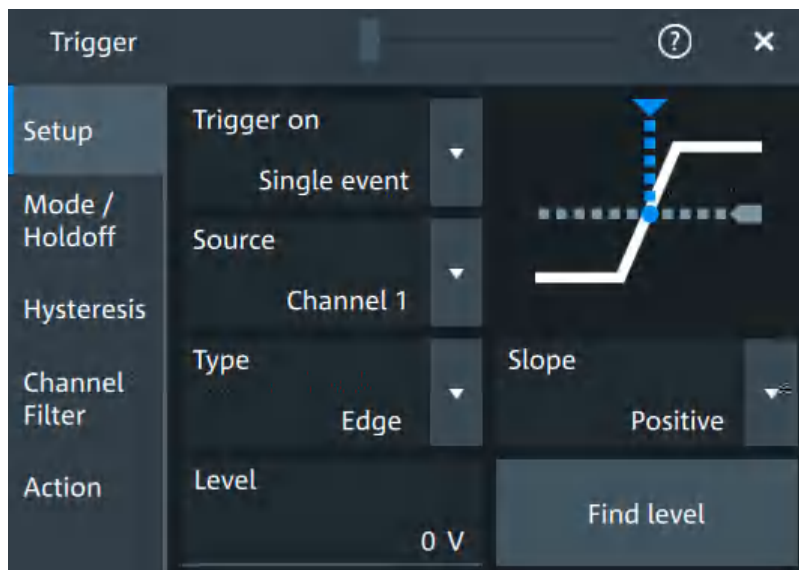

Level

See "Level" on page 137.

Remote command:

`TRIGger:EVENT<ev>:LEVel<n>[:VALue]` on page 493

Slope

Sets the edge direction for the trigger.

"Positive" Selects the rising edge, which is a positive voltage change.

"Negative" Selects the falling edge, which is a negative voltage change.

"Either" Selects the rising and falling edge. After starting an acquisition, the instrument triggers on the first identified edge.

Remote command:

`TRIGger:EVENT<ev>:EDGE:SLOPe` on page 494

7.3.2 Edge trigger on external trigger source

Access: "Menu" > "Trigger" > "Setup" tab > "Source" = "Extern" > "Type = Analog Edge"

If an external trigger signal is connected to the Trigger In connector, and the trigger source is set to "Extern", the analog edge trigger is available. Triggering on an external source is only possible if you trigger on a single event but not for sequences.

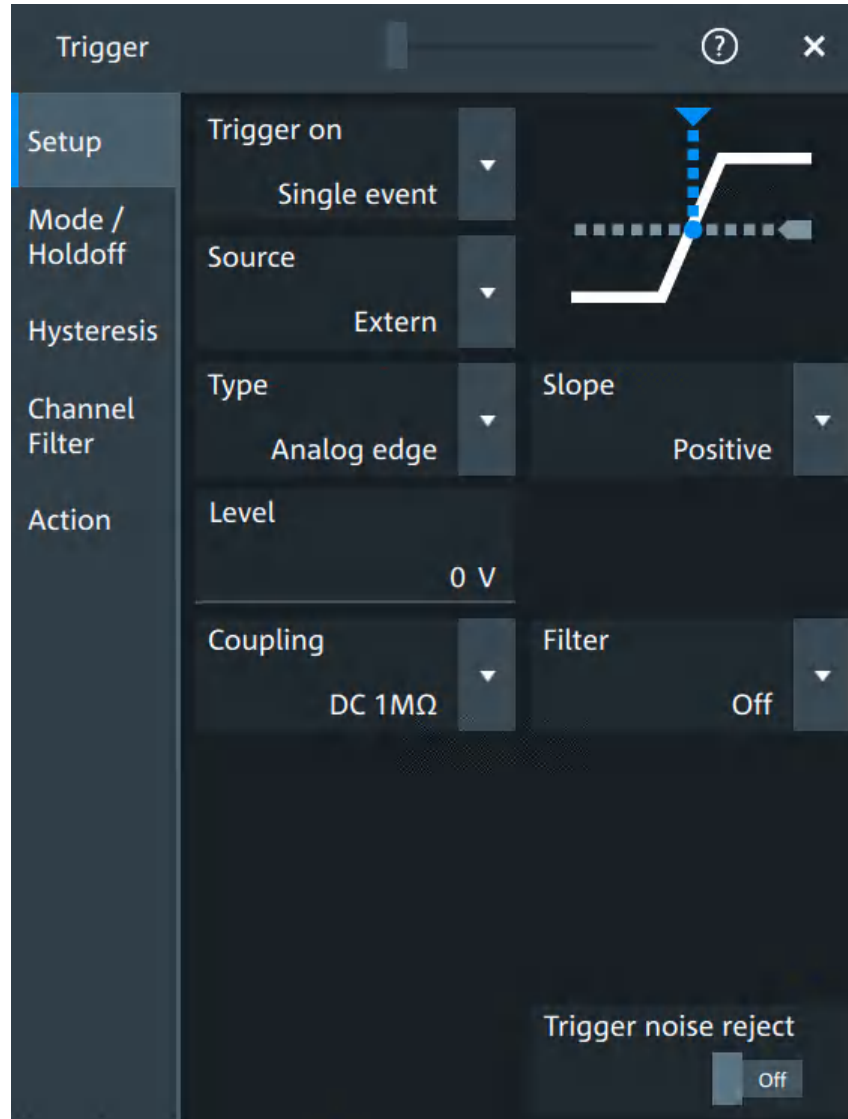

The "Slope" and "Level" are the same settings as for the edge trigger, see:

- ["Level"](#) on page 137
- ["Slope"](#) on page 138

Specific settings for the analog edge trigger are the following:

Coupling

Sets the connection of the external trigger signal, i.e. the input impedance and a termination. The coupling determines what part of the signal is used for triggering.

"DC 50 Ω" Connection with 50 Ω termination, passes both DC and AC components of the signal.

- "DC 1 M Ω " Connection with 1 M Ω termination, passes both DC and AC components of the signal.
- "AC 1 M Ω " Connection with 1 M Ω termination through DC capacitor, removes DC and very low-frequency components. The waveform is centered on zero volts.

Remote command:

[TRIGger:ANEDge:COUPling](#) on page 495

Filter, Cut-off

Selects the filter mode for the external trigger signal, and sets the cut-off frequency.

- "Off" The trigger signal is not filtered.
- "LF reject" Frequencies lower than the "Cut-off" frequency are rejected, higher frequencies pass the filter.
- "RF reject" Frequencies higher than the "Cut-off" frequency are rejected, lower frequencies pass the filter.

Remote command:

[TRIGger:ANEDge:FILTer](#) on page 495

[TRIGger:ANEDge:CUToff:HIGHPass](#) on page 496

[TRIGger:ANEDge:CUToff:LOWPass](#) on page 496

Trigger noise reject

Enables an automatic hysteresis on the trigger level to avoid unwanted trigger events caused by noise.

Remote command:

[TRIGger:ANEDge:NREJect](#) on page 496

7.3.3 Glitch trigger

Access: "Menu" > "Trigger" > "Setup" tab > "Type = Glitch"

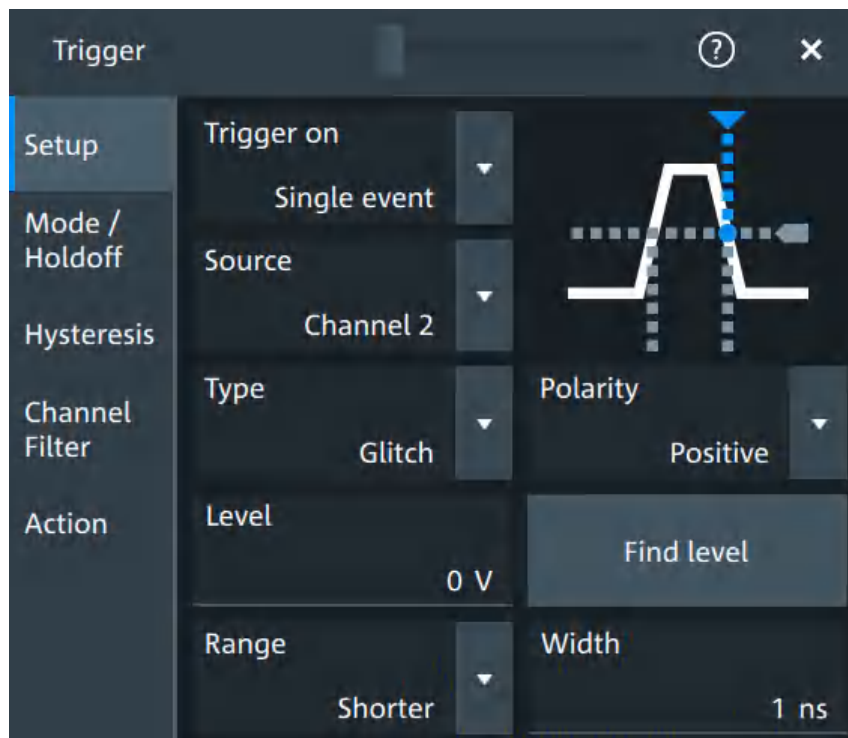
**Level**

See "Level" on page 137.

Remote command:

[TRIGger:EVENT<ev>:LEVel<n>\[:VALue\]](#) on page 493

Polarity

Sets the polarity of a pulse, which is the direction of the first pulse slope.

"Positive" Selects positive going pulses, the width is defined from the rising to the falling slopes.

"Negative" Selects negative going pulses, the width is defined from the falling to the rising slopes.

"Either" Selects both positive and negative going pulses.

Remote command:

[TRIGger:EVENT<ev>:GLITCh:POLarity](#) on page 497

[TRIGger:EVENT<ev>:RUNT:POLarity](#) on page 500

Range

Selects how the time limit of the runt pulse is defined.

Remote command:

[TRIGger:EVENT<ev>:GLITCh:RANGe](#) on page 497

Width

Sets the length of a glitch. The instrument triggers on pulses shorter or longer than this value, depending on the value set with "Range".

You need to know the expected pulse widths of the circuit to set the glitch width correctly.

Remote command:

[TRIGger:EVENT<ev>:GLITCh:WIDTh](#) on page 497

7.3.4 Width trigger

Access: "Menu" > "Trigger" > "Setup" tab > "Type = Width"

The width trigger compares the pulse width (duration) with given time limits. It detects pulses with an exact pulse width, pulses shorter or longer than a given time, and also pulses inside or outside the allowable time range. The pulse width is measured at the trigger level.

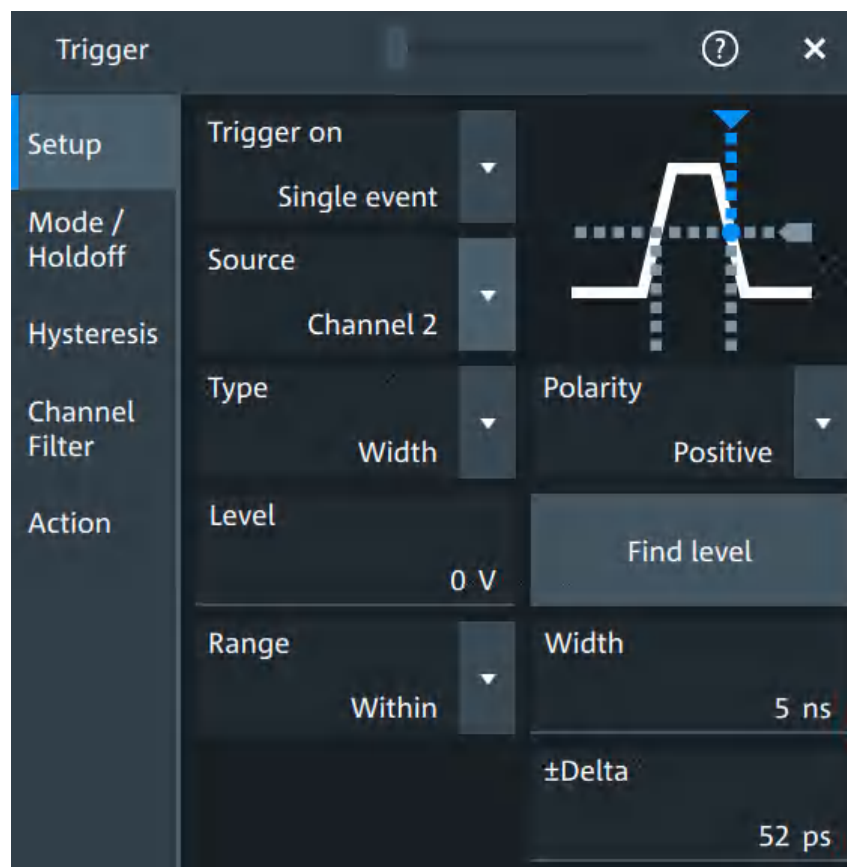

Level

See "[Level](#)" on page 137.

Remote command:

[TRIGger:EVENT<ev>:LEVel<n>\[:VALue\]](#) on page 493

Polarity

Sets the polarity of a pulse, which is the direction of the first pulse slope.

- "Positive" Selects positive going pulses, the width is defined from the rising to the falling slopes.
- "Negative" Selects negative going pulses, the width is defined from the falling to the rising slopes.
- "Either" Selects both positive and negative going pulses.

Remote command:

[TRIGger:EVENT<ev>:WIDTH:POLarity](#) on page 498

Range

Selects how the range of a pulse width is defined.

- "Longer" Triggers on pulses longer than the given "Width".
- "Shorter" Triggers on pulses shorter than the given "Width".
- "Within" Triggers on pulses inside a given range. The range of the pulse width is defined by " $\pm\Delta$ " related to "Width".
- "Outside" Triggers on pulses outside a given range. The range definition is the same as for "Within" range.

Remote command:

[TRIGger:EVENT<ev>:WIDTH:RANGe](#) on page 498

Width

For the ranges "Within" and "Outside", the width defines the center of a range which is defined by the limits " $\pm\Delta$ ".

For the ranges "Shorter" and "Longer", the width defines the maximum and minimum pulse width, respectively.

Remote command:

[TRIGger:EVENT<ev>:WIDTH:WIDTH](#) on page 499

$\pm\Delta$

Defines a range around the width value.

The combination "Range" = "Within" and " $\pm\Delta$ " = 0 triggers on pulses with a pulse width that equals "Width".

The combination "Range" = "Outside" and " $\pm\Delta$ " = 0 means to trigger on pulse widths \neq "Width".

Remote command:

[TRIGger:EVENT<ev>:WIDTH:DELTA](#) on page 498

7.3.5 Runt trigger

Access: "Menu" > "Trigger" > "Setup" tab > "Type = Runt"

A runt is a pulse lower than normal in amplitude. The amplitude crosses the first threshold twice in succession without crossing the second one. For example, this trigger can detect logic, digital, and analog signals remaining below a specified threshold amplitude because I/O ports are in undefined state.



Polarity

Sets the polarity of a pulse, which is the direction of the first pulse slope.

- "Positive" Selects positive going pulses, the width is defined from the rising to the falling slopes.
- "Negative" Selects negative going pulses, the width is defined from the falling to the rising slopes.
- "Either" Selects both positive and negative going pulses.

Remote command:

[TRIGger:EVENT<ev>:GLITCh:POLarity](#) on page 497

[TRIGger:EVENT<ev>:RUNT:POLarity](#) on page 500

Upper level

Sets the upper voltage limit.

Remote command:

[TRIGger:EVENT<ev>:LEVel<n>:RUNT:UPPer](#) on page 500

Lower level

Sets the lower voltage limit.

Remote command:

[TRIGger:EVENT<ev>:LEVel<n>:RUNT:LOWer](#) on page 499

Range

Selects how the time limit of the runt pulse is defined.

"Any runt"	Triggers on all runts fulfilling the level condition, without time limitation.
"Longer"	Triggers on runts longer than the given "Runt width".
"Shorter"	Triggers on runts shorter than the given "Runt width".
"Within"	Triggers if the runt length is inside a given time range. The range is defined by "Runt width" and "±Delta".
"Outside"	Triggers if the runt length is outside a given time range. The range definition is the same as for "Within" range.

Remote command:

[TRIGger:EVENT<ev>:RUNT:RANGe](#) on page 501

Runt width

For the ranges "Shorter" and "Longer", the runt width defines the maximum and minimum pulse width, respectively.

For the ranges "Within" and "Outside", the runt width defines the center of a range which is defined by "±Delta".

Remote command:

[TRIGger:EVENT<ev>:RUNT:WIDTh](#) on page 501

±Delta

Defines a range around the runt width value.

Remote command:

[TRIGger:EVENT<ev>:RUNT:DELTA](#) on page 500

7.3.6 Window trigger

Access: "Menu" > "Trigger" > "Setup" tab > "Type = Window"

The window trigger checks the signal run in relation to a "window". The window is formed by the upper and lower voltage levels. The trigger condition is fulfilled, if the waveform enters or leaves the window, or if the waveform stays inside or outside for a time longer or shorter than specified.

With the window trigger, you can display longer transient effects.

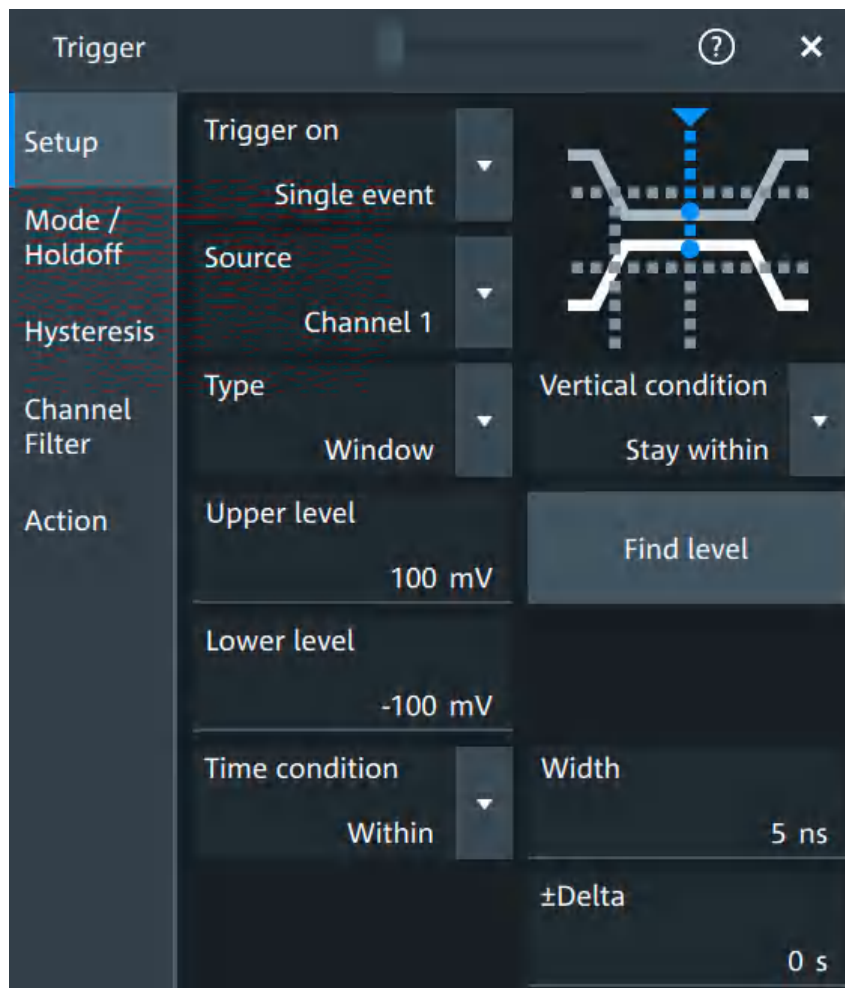

Vertical condition

Selects how the signal run is compared with the window.

- "Enter" Triggers when the signal crosses the upper or lower level and thus enters the window made up of these two levels.
- "Exit" Triggers when the signal leaves the window.
- "Stay within" Triggers if the signal stays between the upper and lower level for a specified time. The time is defined in various ways by the "Time condition".
- "Stay outside" Triggers if the signal stays above the upper level or below the lower level for a specified time. The time is also defined by the "Time condition".

Remote command:

[TRIGger:EVENT<ev>:WINDow:RANGe](#) on page 503

Upper level

Sets the upper voltage limit.

Remote command:

[TRIGger:EVENT<ev>:LEVel<n>:WINDow:UPPer](#) on page 502

Lower level

Sets the lower voltage limit.

Remote command:

[TRIGger:EVENT<ev>:LEVel<n>:WINDow:LOWer](#) on page 502

Time condition

Available for "Vertical condition" = "Stay within"/"Stay outside".

Selects how the time limit of the window is defined.

"Within"	Triggers if the signal stays inside or outside the vertical window limits at least for the time <i>Width - Delta</i> and for <i>Width + Delta</i> at the most.
"Outside"	"Outside" is the opposite definition of "Within". The instrument triggers if the signal stays inside or outside the vertical window limits for a time shorter than <i>Width - Delta</i> or longer than <i>Width + Delta</i> .
"Shorter"	Triggers if the signal crosses vertical limits before the specified "Width" time is reached.
"Longer"	Triggers if the signal crosses vertical limits after the specified "Width" time is reached.

Remote command:

[TRIGger:EVENT<ev>:WINDow:TIME](#) on page 504

Width

For the ranges "Within" and "Outside", the width defines the center of a time range which is defined by the limits " $\pm\Delta$ ".

For the ranges "Shorter" and "Longer", it defines the maximum and minimum time lapse, respectively.

Remote command:

[TRIGger:EVENT<ev>:WINDow:WIDTH](#) on page 504

 $\pm\Delta$

Defines a range around the width value.

Remote command:

[TRIGger:EVENT<ev>:WINDow:DELTA](#) on page 503

7.3.7 Timeout trigger

Access: "Menu" > "Trigger" > "Setup" tab > "Type = Timeout"

The timeout trigger checks if the signal stays above or below the threshold voltage for a specified time lapse. In other words, the trigger occurs if the trigger source does not have the expected transition within the specified time.

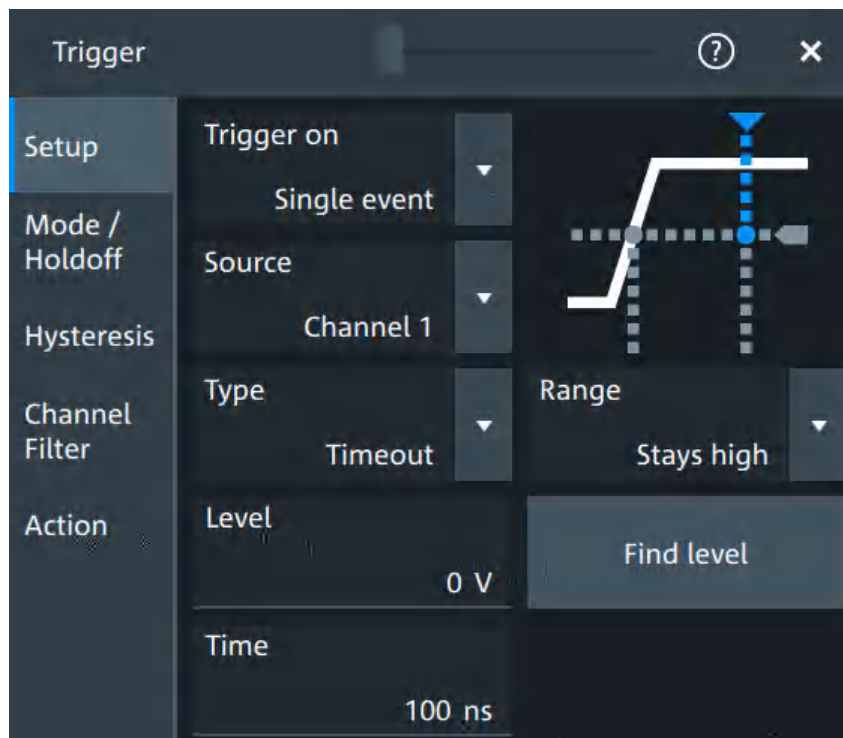
**Level**

Sets the threshold for the high and low signal states.

Remote command:

[TRIGger:EVENT<ev>:LEVel<n>\[:VALue\]](#) on page 493

Range

Sets the relation of the signal level to the trigger level for the timeout trigger.

"Stays high" The signal level stays above the trigger level.

"Stays low" The signal level stays below the trigger level.

"High or low" The signal level stays above or below the trigger level.

Remote command:

[TRIGger:EVENT<ev>:TIMEout:RANGe](#) on page 505

Time

Sets the time limit for the timeout at which the instrument triggers.

Remote command:

[TRIGger:EVENT<ev>:TIMEout:TIME](#) on page 505

7.3.8 Interval trigger

Access: "Menu" > "Trigger" > "Setup" tab > "Type = Interval"

The interval trigger analyzes the time between two pulses.

The interval trigger can analyze either rising or falling edges, but searching for an interval is also possible for both edges at the same time ("Either").

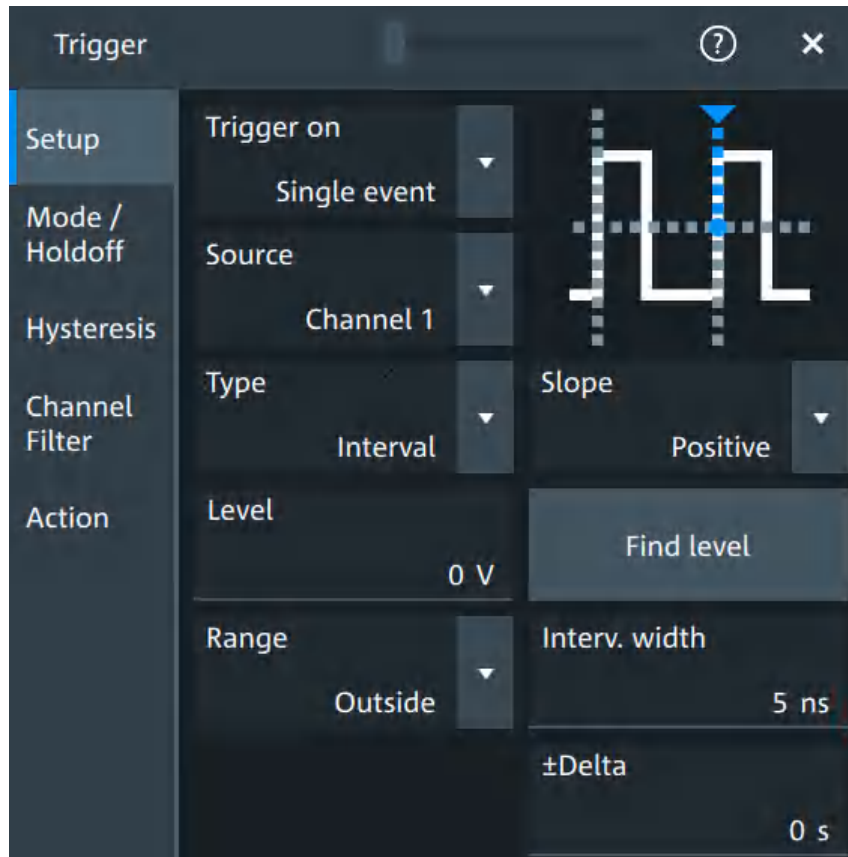

Level

See "Level" on page 137.

Remote command:

[TRIGger:EVENT<ev>:LEVel<n>\[:VALue\]](#) on page 493

Slope

Sets the edge for the trigger. You can analyze the interval between positive edges or between negative edges.

Remote command:

[TRIGger:EVENT<ev>:INTerval:SLOPe](#) on page 507

Range

Selects how the range of an interval is defined:

- "Within" Triggers on pulse intervals inside a given range. The range is defined by "Interv. width" and "±Delta".
- "Outside" Triggers on intervals outside a given range. The range definition is the same as for "Within" range.
- "Shorter" Triggers on intervals shorter than the given "Interv. width".
- "Longer" Triggers on intervals longer than the given "Interv. width".

Remote command:

[TRIGger:EVENT<ev>:INTerval:RANGe](#) on page 506

Interv. width

Sets the time between two pulses for the interval trigger.

Remote command:

[TRIGger:EVENT<ev>:INTerval:WIDTh](#) on page 507

±Delta

Defines a range around the "Interv. width" value.

Remote command:

[TRIGger:EVENT<ev>:INTerval:DELTA](#) on page 506

7.3.9 Slew rate trigger

Access: "Menu" > "Trigger" > "Setup" tab > "Type = Slew rate"

The slew rate trigger is also known as transition trigger. It triggers if the transition time from the lower to higher voltage level (or vice versa) is shorter or longer as defined, or outside or inside a specified time range.

The slew rate trigger finds slew rates faster than expected or permissible to avoid overshooting and other interfering effects. It also detects slow edges violating the timing in pulse series.



Slope

Sets the edge direction for the trigger.

"Positive" Selects the rising edge, which is a positive voltage change.

"Negative" Selects the falling edge, which is a negative voltage change.

"Either" Selects the rising and falling edge. After starting an acquisition, the instrument triggers on the first identified edge.

Remote command:

[TRIGger:EVENT<ev>:SLEW:SLOPe](#) on page 509

Upper level

Sets the upper voltage threshold. When the signal crosses this level, the slew rate measurement starts or stops depending on the selected slope.

Remote command:

[TRIGger:EVENT<ev>:LEVel<n>:SLEW:UPPer](#) on page 508

Lower level

Sets the lower voltage threshold. When the signal crosses this level, the slew rate measurement starts or stops depending on the selected slope.

Remote command:

[TRIGger:EVENT<ev>:LEVel<n>:SLEW:LOWer](#) on page 507

Range

Selects how the time limit for the slew rate is defined. The time measurement starts when the signal crosses the first trigger level - the upper or lower limit depending on the selected slope. The measurement stops when the signal crosses the second level.

"Within"	Triggers on slew rates inside a given time range. The range is defined by "Slew rate" and " $\pm\Delta$ ".
"Outside"	Triggers on slew rates outside a given time range. The range definition is the same as for "Within" range.
"Shorter"	Triggers on slew rates shorter than the given "Slew rate" limit.
"Longer"	Triggers on slew rates longer than the given "Slew rate" limit.

Remote command:

[TRIGger:EVENT<ev>:SLEW:RANGe](#) on page 508

Slew rate

For the ranges "Within" and "Outside", the slew rate defines the center of a range which is defined by the limits " $\pm\Delta$ ".

For the ranges "Shorter" and "Longer", the slew rate defines the maximum and minimum slew rate limits, respectively.

Remote command:

[TRIGger:EVENT<ev>:SLEW:RATE](#) on page 509

$\pm\Delta$

Defines a time range around the given slew rate.

Remote command:

[TRIGger:EVENT<ev>:SLEW:DELTA](#) on page 508

7.3.10 Line trigger

Access: "Menu" > "Trigger" > "Setup" tab > "Source" = "Line"

The line trigger is an edge trigger that triggers on the AC power input and synchronizes the signal to the AC power frequency. It is not a trigger type but rather a special trigger source. Use the line source if you want to analyze signals related to the power line frequency, such as lighting equipment and power supply devices.

Slope

Selects the rising or falling edges of the AC power input.

7.4 Trigger mode / holdoff

Access: "Trigger" menu > "Mode / holdoff" tab

Holdoff conditions define a waiting time after the current trigger until the next trigger can be recognized.

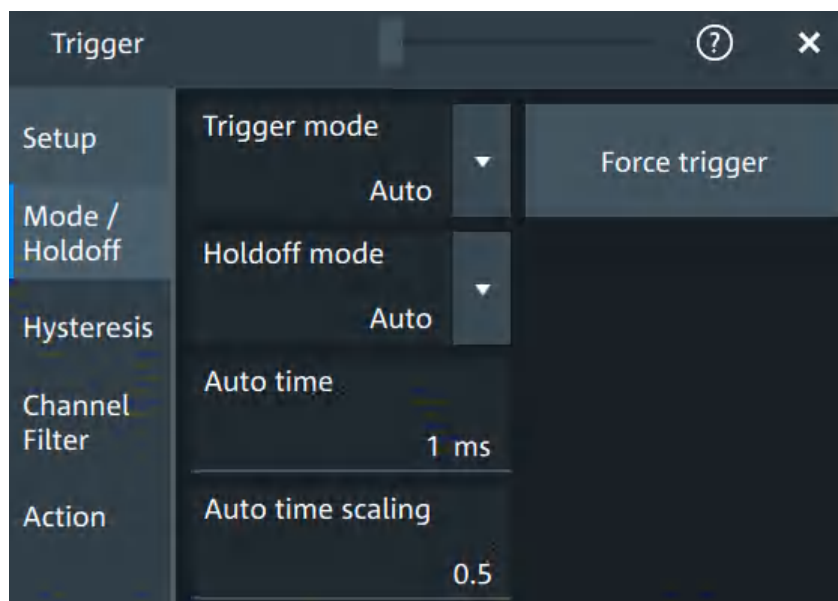

Trigger mode

Sets the trigger mode which determines the behavior of the instrument if no trigger occurs. The current setting is shown on the trigger label.

To toggle quickly between "Auto" and "Normal" mode, use the [Auto Norm] key on the front panel (in "Trigger" section).

- | | |
|------------|---|
| "Auto" | The instrument triggers repeatedly after a time interval if the trigger conditions are not fulfilled. If a real trigger occurs, it takes precedence. This mode helps to see the waveform even before the trigger conditions are set correctly. The waveform on the screen is not synchronized, and successive waveforms are not triggered at the same point of the waveform. The time interval depends on the time base settings. |
| "Normal" | The instrument acquires a waveform only if a trigger occurs, that is, if all trigger conditions are fulfilled. If no trigger occurs, no waveform is acquired and the last acquired waveform is displayed. If no waveform was captured before, none is displayed.
When no trigger has been found for longer than one second, a message box appears that shows the time elapsed since the last trigger. |
| "Free run" | The instrument starts acquisition immediately and triggers after a short time interval independent of the time base settings and faster than in "Auto" mode. Real triggers are ignored. Use this mode if the "Auto" mode is too slow. |

Remote command:

`TRIGger:MODE` on page 510

Force trigger

Provokes an immediate single acquisition. Force the trigger if the acquisition is running in normal mode and no valid trigger occurs. Thus, you can confirm that a signal is available and use the waveform display to determine how to trigger on it.

Remote command:

[TRIGger:FORCe](#) on page 510

Holdoff mode

Selects the method to define the holdoff condition.

The trigger holdoff defines when the next trigger after the current will be recognized. Thus, it affects the next trigger to occur after the current one. Holdoff helps to obtain stable triggering when the oscilloscope is triggering on undesired events.

Holdoff settings are not available if the trigger source is an external trigger input or serial bus, and if you trigger on a sequence of events.

Example:

For example, you want to analyze the first pulse in a burst of several pulses. At first, you select a sufficiently slow time base to display the entire burst. Then, you set the holdoff time a little longer than the length of the burst. Now, each trigger corresponds to the first pulse in successive bursts, and you can change the time base to display the waveform in more detail.

The following methods are available:

"Time"	Defines the holdoff directly as a time period. The next trigger occurs only after the "Holdoff time" has passed.
"Events"	Defines the holdoff as a number of trigger events. The next trigger only occurs when this number of events is reached. The number of triggers to be skipped is defined in "Holdoff events".
"Random"	Defines the holdoff as a random time limited by "Minimum time" and "Maximum time". For each acquisition cycle, the instrument selects a new random holdoff time from the specified range. Random holdoff prevents synchronization to discover effects invisible with synchronized triggering, for example, the features of a pulse train.
"Auto"	The holdoff time is calculated automatically based on the current horizontal scale. "Auto time scaling" defines the factor that the horizontal scale is multiplied with. "Auto time" shows the resulting holdoff time: <i>Auto time = Auto time scaling * Horizontal scale</i> .
"Off"	No holdoff

Remote command:

[TRIGger:HOLDoff:MODE](#) on page 511

[TRIGger:HOLDoff:TIME](#) on page 513

[TRIGger:HOLDoff:EVENTs](#) on page 512

[TRIGger:HOLDoff:MAX](#) on page 512

[TRIGger:HOLDoff:MIN](#) on page 513

[TRIGger:HOLDoff:AUTotime?](#) on page 511

[TRIGger:HOLDoff:SCALing](#) on page 512

7.5 Hysteresis

Access: "Menu">"Trigger" > "Hysteresis"

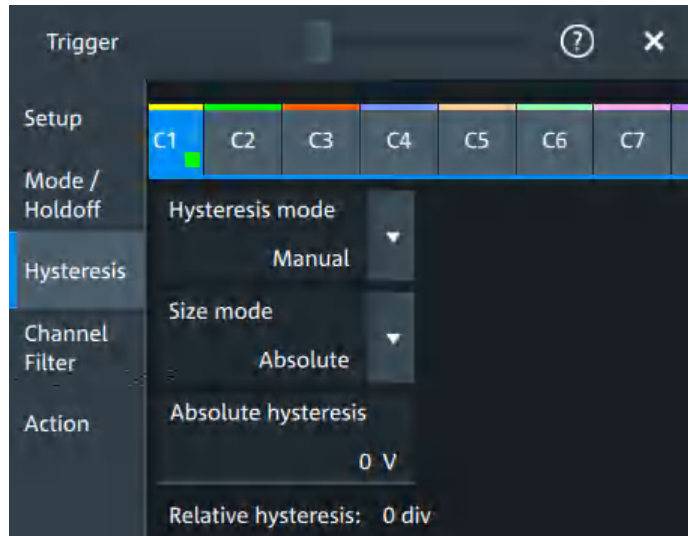

The rejection of noise by setting a hysteresis avoids unwanted trigger events caused by noise oscillation around the trigger level.

HW hysteresis

Displays the hysteresis that is set by the instrument in automatic hysteresis mode.

Remote command:

[TRIGger:NOISe<m>:EFFective?](#) on page 514

Hysteresis mode

Selects how the hysteresis is set.

"Auto" Automatic mode is the recommended mode. The hysteresis is set by the instrument to reject the internal noise of the instrument.

"Manual" The hysteresis is defined directly in absolute or relative values.

Remote command:

[TRIGger:NOISe<m>:MODE](#) on page 514

Size mode

Selects whether the hysteresis is defined in absolute or relative values. The setting is available only in manual hysteresis mode.

Remote command:

[TRIGger:NOISe<m>:MODE](#) on page 514

Absolute hysteresis

Defines a range in absolute values around the trigger level. If the signal oscillates inside this range and thus crosses the trigger level, no trigger event occurs.

Remote command:

[TRIGger:NOISe<m>:ABSolute](#) on page 513

Relative hysteresis

Defines a range in divisions around the trigger level in division or as percentage. If the signal oscillates inside this range and thus crosses the trigger level, no trigger event occurs.

Remote command:

[TRIGger:NOISe<m>:PERDivision](#) on page 514

[TRIGger:NOISe<m>:RELative](#) on page 515

7.6 Channel filter

Access: "Menu">"Trigger" > "Channel filter"

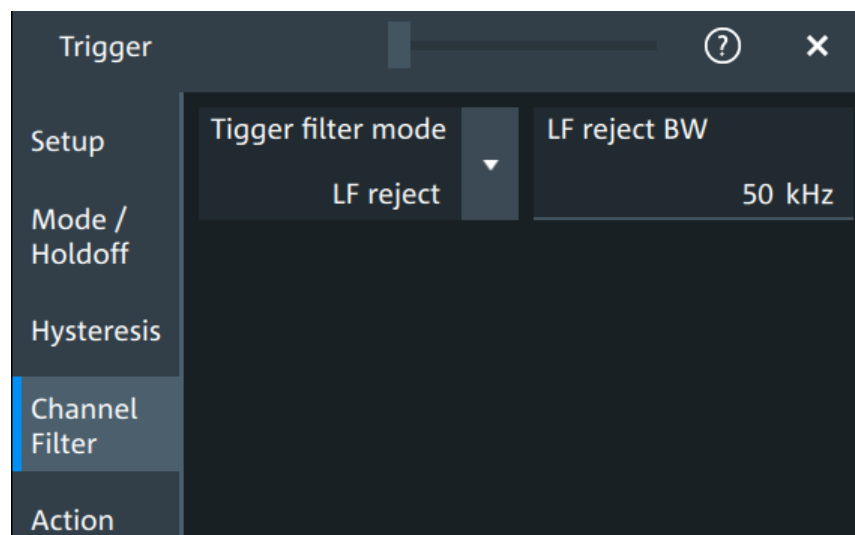
**Trigger filter mode**

Selects the filter mode for the trigger channel.

- "Off" The trigger signal is not filtered.
- "LF reject" Frequencies lower than the "LF reject BW" are rejected, higher frequencies pass the filter.
- "RF reject" Frequencies higher than the "RF reject BW" are rejected, lower frequencies pass the filter.

Remote command:

[TRIGger:FILTermode](#) on page 515

LF reject BW

Sets the limit frequency limit for the highpass filter of the trigger signal. Frequencies lower than this value are rejected, higher frequencies pass the filter.

Remote command:

[TRIGger:LFReject](#) on page 516

RF reject BW

Sets the limit frequency limit for the lowpass filter of the trigger signal. Frequencies higher than this value are rejected, lower frequencies pass the filter.

Remote command:

[TRIGger:RFReject](#) on page 516

7.7 Actions on trigger

Access: "Menu" > "Trigger" > "Action" tab

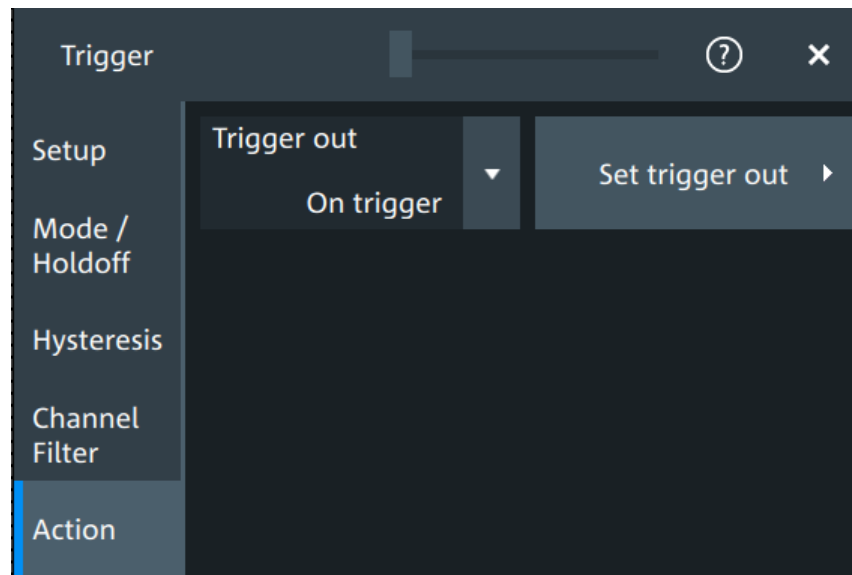

The action settings define what happens when a trigger occurs. All available actions can be initiated at the same time.

Trigger out

Selects, if a pulse is provided to the [Trigger Out] connector on the rear panel. The trigger-out signal is used to synchronize the measurements of other instruments.

To adjust the outgoing signal, tap "Set trigger out".

Remote command:

[TRIGger:ACTions:OUT:STATe](#) on page 516

Set trigger out

Opens a dialog to adjust the trigger out pulse.

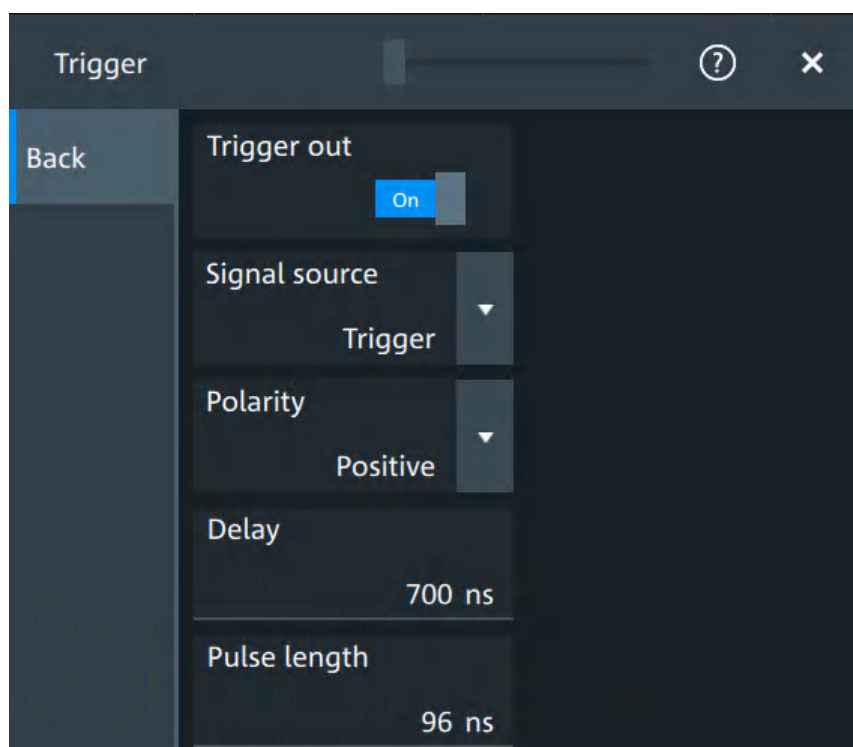
**Trigger out** ← **Set trigger out**

Activates the outgoing pulse on the [Trigger Out] connector on the rear panel.

Remote command:

[TRIGger:ACTions:OUT:STATE](#) on page 516

Signal source ← **Set trigger out**

Defines when the trigger out signal is initiated: at the trigger point, when waiting for the trigger, or when the post-trigger time is finished.

Remote command:

[TRIGger:ACTions:OUT:SOURce](#) on page 517

Polarity ← **Set trigger out**

Sets the polarity of the trigger out pulse, which is the direction of the first pulse edge.

Remote command:

[TRIGger:ACTions:OUT:POLarity](#) on page 517

Delay ← **Set trigger out**

Defines the delay of the first pulse edge to the trigger point. The minimum delay is 600 ns.

Remote command:

[TRIGger:ACTions:OUT:DELay](#) on page 517

Pulse length ← **Set trigger out**

Sets the length of the trigger out pulse.

Remote command:

[TRIGger:ACTions:OUT:PLENgtH](#) on page 517

8 Waveform analysis

This chapter describes general methods to check and analyze waveforms. These are:

- [Zoom](#)..... 160
- [Mathematics](#)..... 164
- [History](#)..... 170
- [Reference waveforms](#)..... 176

8.1 Zoom

The zoom magnifies a part of the waveform to view more details. The zoom is applied to all waveforms that are visible in a diagram.

For each diagram, you can define one zoom area.

- You can define the zoom by drawing, moving and adjusting the zoom area on the touchscreen.
- You can precisely define the size of the zoom area by entering start and stop values in a dialog box.

Zoom areas can be used for gating, for example, to define a measurement gate. You can set the gate exactly to the limits of the zoom.

8.1.1 Zoom settings

Access: "Menu" > "Horizontal" > "Zoom" tab.

The "Zoom" tab allows you to specify start and stop values for the x- and y-axes. The acquired data within these ranges is zoomed.

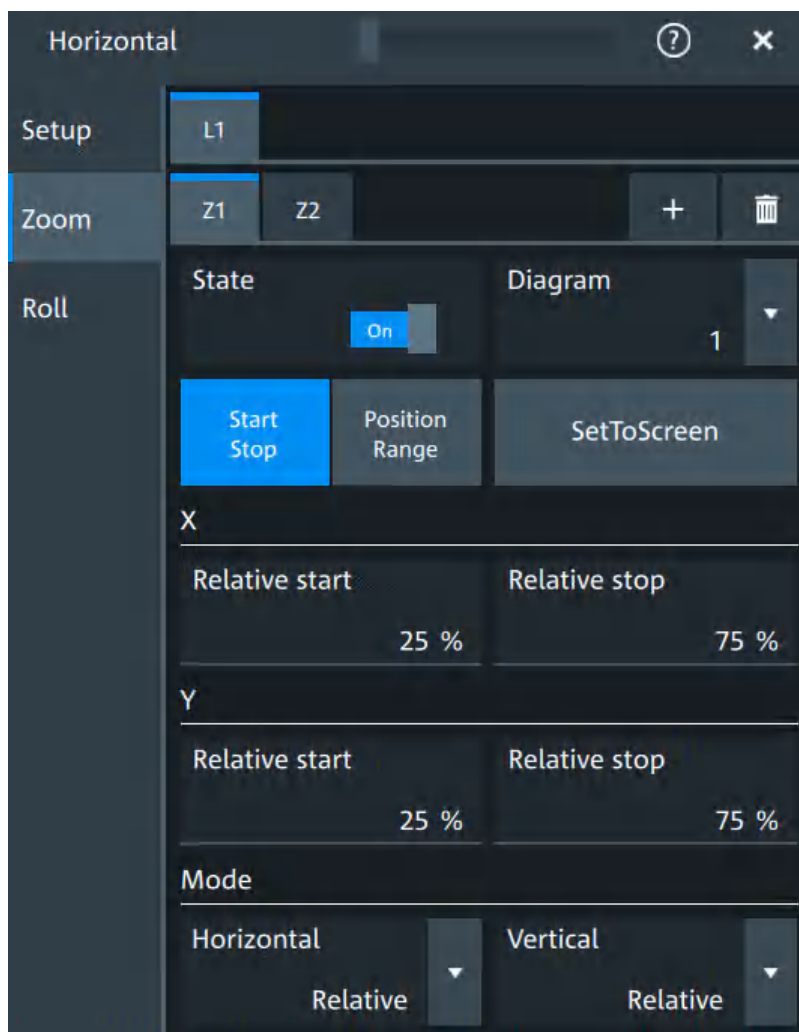
**Tabx**

Selects one of the enabled SmartGrid layouts.

Zx

Selects the zoom window. You can add up to 8 different zooms.

State

Enables the zoom.

Remote command:

[LAYout<ly>:ZOOM<zo>\[:ENABle\]](#) on page 519

Diagram

Indicates which of the waveform diagrams is selected for zooming. The number is displayed on the screen in the middle of each diagram.

Remote command:

[LAYout<ly>:ZOOM<zo>:SOURce](#) on page 523

Start Stop, Position range

Selects how the window for the zoom diagram is defined. You can select between defining "Start Stop" values or "Position range".

Start Stop

The "Start Stop" tab allows you to specify start and stop values for the x- and y-axes. The acquired data within these ranges is zoomed.

According to the selected "Mode", absolute or relative values are used.

"Start", "Relative start"

Defines the lower limit of the zoom area on the axis.

"Stop", "Relative stop"

Defines the upper limit of the zoom area on the axis.

Remote command:

[LAYout<ly>:ZOOM<zo>:HORizontal:ABSolute:START](#) on page 520

[LAYout<ly>:ZOOM<zo>:HORizontal:RELative:START](#) on page 522

[LAYout<ly>:ZOOM<zo>:HORizontal:ABSolute:STOP](#) on page 520

[LAYout<ly>:ZOOM<zo>:HORizontal:RELative:STOP](#) on page 522

[LAYout<ly>:ZOOM<zo>:VERTical:RELative:START](#) on page 525

[LAYout<ly>:ZOOM<zo>:VERTical:ABSolute:START](#) on page 524

[LAYout<ly>:ZOOM<zo>:VERTical:RELative:STOP](#) on page 526

[LAYout<ly>:ZOOM<zo>:VERTical:ABSolute:STOP](#) on page 524

Position range

If "Position range" is selected, you specify the x and y position of center point of the zoom area plus a range for the x- and y-axes. The area defined by that point and the ranges is zoomed. You can set absolute values or relative values (in percent of the screen, depending on the "Mode" selection).

"Range" Defines the width or height of the zoom area.

"Position" Defines the x or y value of the centerpoint of the zoom area.

Remote command:

[LAYout<ly>:ZOOM<zo>:HORizontal:ABSolute:POSition](#) on page 519

[LAYout<ly>:ZOOM<zo>:HORizontal:RELative:POSition](#) on page 521

[LAYout<ly>:ZOOM<zo>:HORizontal:ABSolute:SPAN](#) on page 520

[LAYout<ly>:ZOOM<zo>:HORizontal:RELative:SPAN](#) on page 522

[LAYout<ly>:ZOOM<zo>:VERTical:ABSolute:POSition](#) on page 523

[LAYout<ly>:ZOOM<zo>:VERTical:RELative:POSition](#) on page 525

[LAYout<ly>:ZOOM<zo>:VERTical:ABSolute:SPAN](#) on page 524

[LAYout<ly>:ZOOM<zo>:VERTical:RELative:SPAN](#) on page 526

Set to screen

Sets the zoom area to the whole screen.

Mode

Defines if absolute or relative values are used to specify the "Horizontal" (x-axis) and the "Vertical" (y-axis) values.

Remote command:

LAYout<ly>:ZOOM<zo>:HORizontal:MODE on page 521

LAYout<ly>:ZOOM<zo>:VERTical:MODE on page 525

8.1.2 Zooming for details

To define the zoom area on the touchscreen

For graphical zooming, you use your finger on the screen.

1. On the toolbar, tap the "Add zoom" icon.



The zoom overlay menu opens.

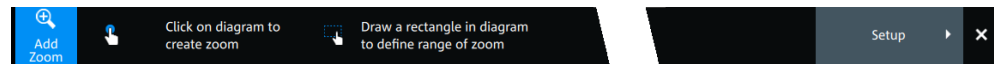

2. Draw a rectangle in the diagram that defines the zoomed area. While you drag your finger on the touchscreen, a dotted rectangle indicates the current zoom area. The indicated area is magnified in a new zoom diagram. The original diagram shows the zoom area as a rectangle.
3. If the position of the zoom area is not correct, drag the rectangle in the overview to the correct position.
4. If the size of the zoom area is not yet ideal, tap the rectangle in the overview diagram. Now, 4 white lines indicate the edges of the zoom area. A dashed white line indicates the selected edge, which you can adjust.
5. Touch the edge that you want to move. Drag it to the required position.

To create a zoom using the zoom dialog box

- ▶ If you want to create a new, unconfigured zoom, tap the "Add" icon.



To define the zoom area numerically using start/stop values

1. Open "Menu" > "Horizontal".
2. In the "Zoom" tab, select "Start Stop".
3. Select a value for "Mode" > "Horizontal" to define "Absolute" or "Relative" x-axis values. Relative values cause the zoom area to adapt to the input values dynamically.

4. For "X", define the "Relative start" and "Relative stop" values. They define the lower and upper borders of the zoom area on the x-axis.
5. Select the "Mode" > "Vertical" to define "Absolute" or "Relative" y-axis values.
6. For "Y", define the "Relative start" and "Relative stop" values. They define the lower and upper borders of the zoom area on the y-axis.

When you close the dialog box, the specified area is magnified in a new zoom diagram. The original diagram is displayed with the zoom area indicated as a rectangle.

To define the zoom area numerically using position and range values

1. Open "Menu" > "Horizontal".
2. In the "Zoom" tab, select "Position range".
3. Select "Mode" > "Horizontal" to define "Absolute" or "Relative" x-axis values. Relative values cause the zoom area to adapt to the input values dynamically.
4. Under "X" > "Position", define the x-value of the center point of the zoom area.
5. Under "X" > "Range", define the width of the zoom area.
6. Select the "Mode" > "Vertical" to define "Absolute" or "Relative" y-axis values.
7. Under "Y" > "Position", define the y-value of the center point of the zoom area.
8. Under "Y" > "Range", define the height of the zoom area.

When you close the dialog box, the specified area is magnified in a new zoom diagram. The original diagram is displayed with the zoom area indicated as a rectangle.

8.2 Mathematics

Math waveforms are calculated waveforms. You can define up to 8 math waveforms and display them on the screen, and use it as source for further analysis.

It is calculated out of one or two analog channels, or another math waveform using several predefined operations. You can define up to 5 equations. The complete configuration is called equation set and can be saved for later use.

You can analyze math waveforms in the same way as channel waveforms: use zoom, perform automatic and cursor measurements, and save as reference waveform.

You can store a math waveform as a reference waveform and restore it later.

8.2.1 Displaying math waveforms

Math waveforms can be displayed in addition to the channel and other waveforms. They also can be used for analysis, e.g. measurements, even if the math waveform is not active.

1. Open "Menu" > "Math" > "Setup".
Alternatively, press the [Math] key.
2. Select the math "Operator".
3. If necessary, define the settings for the operator.
4. Tap "Display".

The math waveform is displayed on the screen. Also a green dot appears in the enabled math tab.



5. To change the vertical scaling of the math waveform, open the "Scale" tab.
6. Set the "Scale mode" to "Manual".
7. Enter the "Vertical scale" factor (per division). If necessary, add a "Vertical offset".
By default the instrument performs an automatic scaling.
8. Close the "Math" dialog box.

8.2.2 Math waveforms settings

Access: [Math] > "Setup" tab

You can define up to eight different math waveforms. Each waveform is defined in a separate tab in the "Math" dialog box ("M1" to "M8").

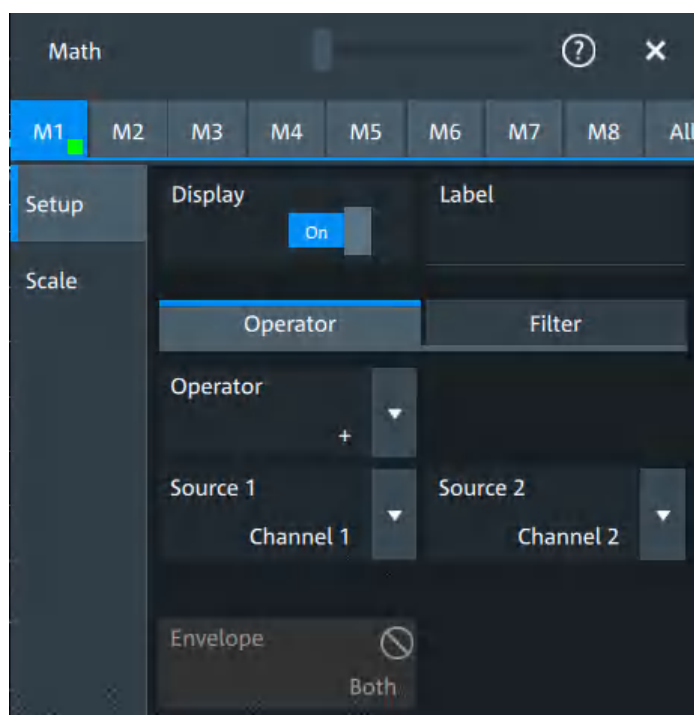

You can also find a summary of the state of all math channels in the "All" tab.

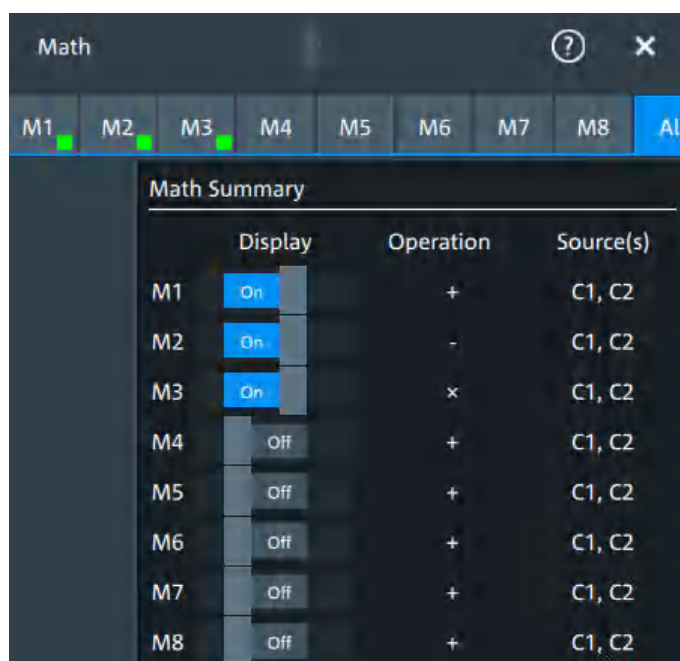

Display

Activates the selected Math channel and displays the defined math waveforms.

Remote command:

[CALCulate:MATH<m>:STATE](#) on page 526

Label

Adds a label to the math waveform.

Operator

Defines the type of operation to be performed on the selected signal sources.

The following functions are available:

"+"	Adds the values of 2 sources (channel or math waveform).
"-"	Subtracts source 2 from source 1.
"x"	Multiplies the two sources.
"/"	Divides source 1 by source 2.
"1/x"	Calculates the reciprocal of the source.
"- x"	Calculates the negative value of the source.
" x "	Determines the absolute value of the source.
" $\Delta x/\Delta t$ "	Differentiates the source value relating to the time value. Not possible on envelope waveforms and waveforms with "Peak detect" decimation.
"Integral"	Calculates the definite integral of the source.
"log(x)"	Calculates the logarithm of the source value based on 10.
"ln(x)"	Calculates the natural logarithm of the source value (based on e).
"ld(x)"	Calculates the binary logarithm of the source value (binary logarithm, based on 2).
"x ² "	Squares the source. If the source contains negative values that have been clipped, then the result contains positive clipping.
" \sqrt{x} "	Calculates the square root of the source. Note that the square root of a negative number is undefined and the result is clipped.
"Rescale"	Rescaling of x.

Remote command:

`CALCulate:MATH<m>[:EXPRession][:DEFine]` on page 527

Source 1, Source 2

Defines the signal source to be evaluated by the math function.

a, b

Defines the values for the rescale function, if "Operator" = "Rescale"

"a"	Multiplication factor
"b"	Offset of the signal source on the y-axis.

Noise reject

Only available for "Operator" = "dx/dt".

Sets the number of neighboring samples that are skipped for differentiation.

To suppress noise effects during differentiation, it can be useful not to consider two directly neighboring points to calculate dx ($x_n - x_{n-1}$). Instead, some samples in-between are skipped and a point a few samples further is used (e.g. $x_n - x_{n-3}$).

Envelope wfm selection

Selects the upper or lower part of the input waveform for mathematic calculation, or a combination of both.

Remote command:

[CALCulate:MATH<m>:ENVSelection](#) on page 529

8.2.3 Math filter

Access:[Math] > "Filter" tab

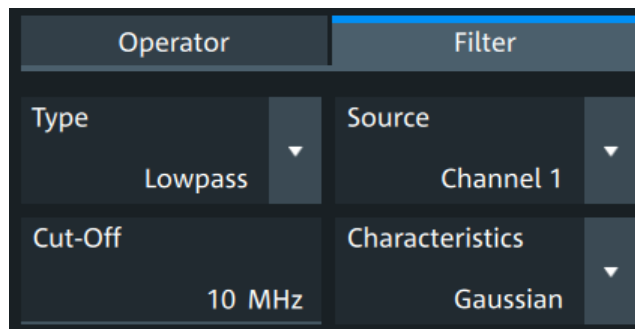

The finite impulse response filter is a filter to create filtered math waveforms with low-pass or highpass. The filter requires additional settings.

In remote control, filter settings are defined in the expression string, see [CALCulate:MATH<m>\[:EXPRession\]\[:DEFine\]](#) on page 527.

Type

Selects, if the filter is highpass or lowpass.

Source 1

Selects the input channel of the signal.

Cut-off

Sets the limit frequency for the filter.

Cutoff frequency for lowpass filter

The cutoff frequency depends on the horizontal resolution and the filter characteristics. The frequency for the lowpass filter can only be set in this range:

$$f_{g_3dB} = (0.001 \dots 0.2) * f_{a_in} \text{ for Gaussian FIR filter}$$

$$f_{g_3dB} = (0,001 \dots 0.4) * f_{a_in} \text{ for rectangular FIR filter}$$

Where: f_{g_3dB} = cutoff frequency to be set for the lowpass filter, and f_{a_in} = reciprocal of the resolution, or sample rate.

Cutoff frequency for highpass filter

To check limit frequency for the highpass filter, convert it to an equivalent lowpass frequency:

$$f_{LP} = f_{a_in}/2 - f_{HP}$$

Where f_{HP} is the requested highpass limit frequency and f_{LP} the equivalent lowpass frequency that has to comply with the limits given above.

Characteristics

Selects if a Gaussian or a rectangular shape is used for the lowpass filter. The high-pass filter is always Gaussian.

8.2.4 Math scale settings

Access:[Math] > "Scale" tab

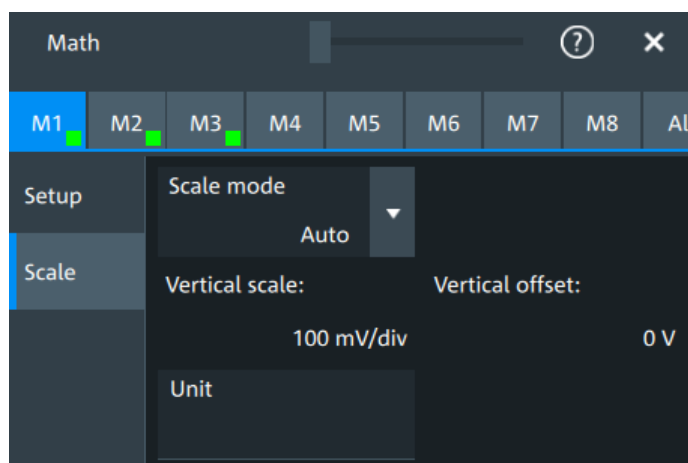

Scale mode

By default, the vertical scale is adapted to the current measurement results automatically to provide an optimal display. However, if necessary, you can define scaling values manually to suit your requirements.

"Manual" Enter the required values for "Vertical scale" and "Vertical offset".

"Auto" "Vertical scale" and "Vertical offset" are read-only.

Remote command:

[CALCulate:MATH<m>:VERTical:SCALE:MODE](#) on page 529

Vertical scale

Sets the scale of the y-axis in the math function diagram. The value is defined as "<unit> per division", e.g. *50 mV/div*. In this case, the horizontal grid lines are displayed in intervals of 50 mV.

If [Scale mode](#) is set to "Auto", this setting is read-only.

Remote command:

[CALCulate:MATH<m>:VERTical:SCALE\[:VALue\]](#) on page 528

Vertical offset

Sets a voltage offset to adjust the vertical position of the math function on the screen. Negative values move the waveform up, positive values move it down.

If [Scale mode](#) is set to "Auto", this setting is read-only.

Remote command:

`CALCulate:MATH<m>:VERTical:OFFSet` on page 528

Unit

Sets a user-defined unit for the math operation.

8.3 History

The history accesses the data of previous acquisitions and provides them for further analysis.

8.3.1 About history

If a continuous acquisition runs, the captured data is stored in the sample memory and the current acquisition is processed and shown on the display. After the acquisition is stopped, the history accesses the captured samples that were stored, displays these samples as history waveforms, and makes them available for further analysis. It considers all channels that were enabled during the running acquisition.

When a new acquisition is started with [Single], the memory is cleared and written anew. In continuous acquisition, stopping and starting the acquisition does not clear the memory, and the history memory is continued. When the memory is full, new acquisitions are stored, and the oldest are removed (first in, first out). The history memory is cleared when the acquisition parameters are changed. To clear the history memory on demand, use the [Clear] key or the "Clear" tool on the toolbar.

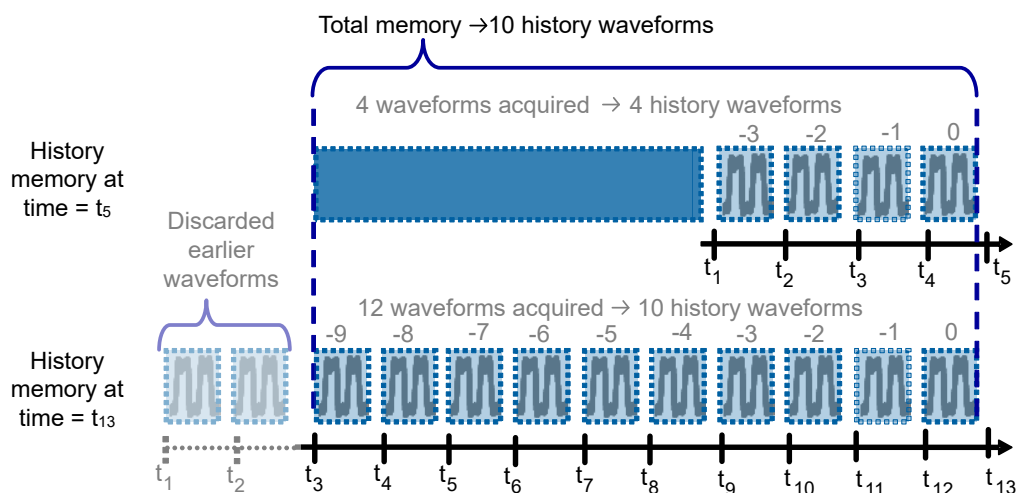

Figure 8-1: History memory. In this example, the memory can store 10 waveforms.

The number of stored history waveforms depends on the memory size, the number of enabled channels, and the record length. The shorter the record length, the less the number of channels, and the larger the memory, the more history waveforms are saved.

You can work with history waveforms in the same way as with the waveform of the latest acquisition: use zoom, cursors, measurements, create math waveforms and so on. You can also save a single history waveform for further analysis.

8.3.2 History setup

The "History" dialog contains the complete functionality on history viewing and information.

The most important information and functions are also provided in the quick-access history dialog box.

Access: "Menu" > "Acquisition" > "History" tab.

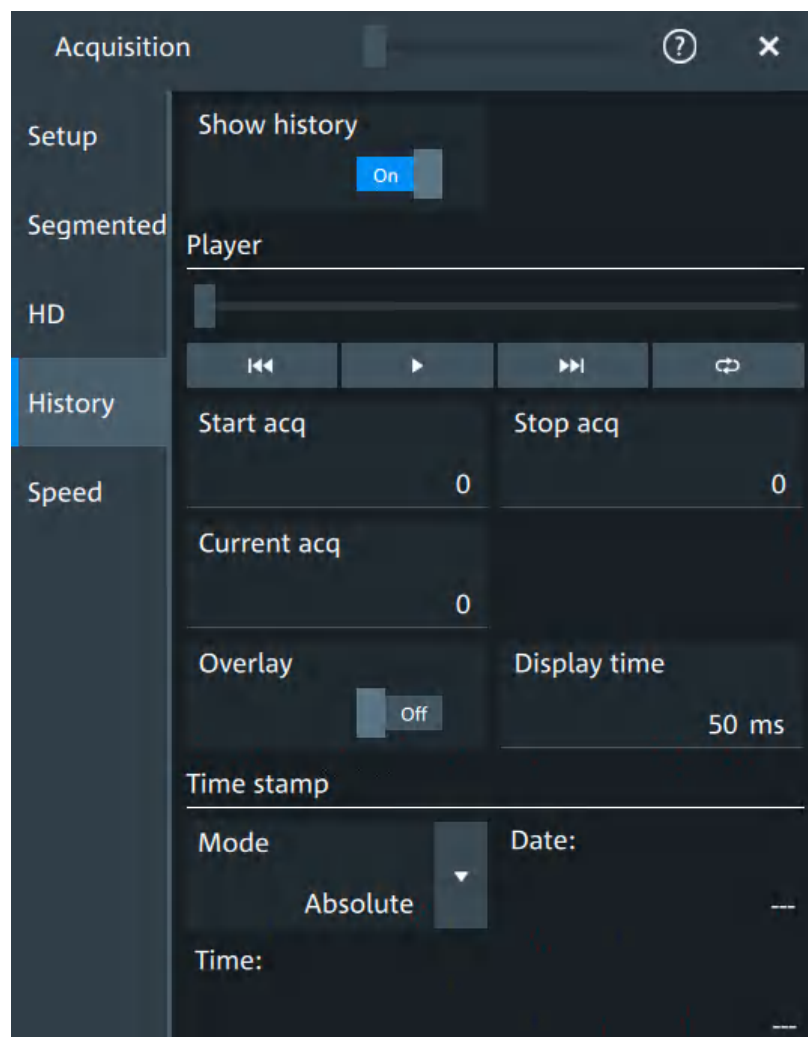

Show history.....	172
Player.....	172
Start acq.....	172
Stop acq.....	172
Current acq.....	172

Overlay.....	173
Display time.....	173
Time stamp.....	173

Show history

Enables the history mode and allows you to save history waveforms to file.





The history display is enabled automatically when you press the [History] button. It is disabled when you close the quick-access "History" dialog box.

Remote command:

[ACQUIRE:HISTORY\[:STATe\]](#) on page 534

Player

The player can be used to control the playback of the history waveforms.

	Sets the oldest acquisition in the sample memory as "Start acq" and "Current acq".
	Starts and stops the replay of the history waveforms from "Start acq" to "Stop acq".
	Sets the newest acquisition in the sample memory as "Stop acq" and "Current acq". This acquisition always has the index "0".
	"Auto repeat": If selected, the playback of the selected history segments repeats automatically. See also: " Auto repeat " on page 174.

Remote command:

[ACQUIRE:HISTORY:PLAY](#) on page 531

Start acq

Sets the index of the first (oldest) acquisition to be displayed or exported. The index is always negative.

Remote command:

[ACQUIRE:HISTORY:START](#) on page 532

Stop acq

Sets the index of the last (newest) acquisition to be displayed or exported. The newest acquisition of the complete acquisition series always has the index "0".

Remote command:

[ACQUIRE:HISTORY:STOP](#) on page 532

Current acq

Accesses a particular acquisition in the memory to display it, or to save it. The newest acquisition always has the index "0". Older acquisitions have a negative index.

If a history replay is running, the field shows the number of the currently shown acquisition.

Remote command:

[ACQUIRE:HISTORY:CURRENT](#) on page 531

Overlay

Displays the segments with infinite persistence. Thus, you can see all data points of all displayed segments of a player cycle. Same setting as "Infinite persistence" on page 85.

Display time

Sets the display time for one acquisition. The shorter the time, the faster the replay is. The setting takes effect for usual history replay and the display of a fast segmentation series via the history.

Remote command:

[ACQUIRE:HISTORY:TPACq](#) on page 532

Time stamp

The time stamp shows the time of the currently displayed history acquisition. Thus, the time relation between acquisitions is always available.

The time stamp "Mode" can be absolute or relative:

- In "Absolute" mode, the instrument shows the date and the daytime of the current acquisition.
- In "Relative" mode, the time difference to the newest acquisition (index = 0) is shown.

During history replay, the time value is displayed and updated if the replay speed ("Display time") is slow enough, that is 40 ms or slower.

The quick-access history dialog box always shows the time according to the "Mode" that is selected in the "Acquisition" > "History" tab.

Remote command:

[ACQUIRE:HISTORY:TSDATE?](#) on page 533

[ACQUIRE:HISTORY:TSABSOLUTE?](#) on page 532

[ACQUIRE:HISTORY:TSRELATIVE?](#) on page 533

[ACQUIRE:HISTORY:TSREFERENCE?](#) on page 533

8.3.3 Quick access history dialog

The quick access history dialog is visible when the history is active. Closing the dialog disables the history display ("Show history" = "Off")

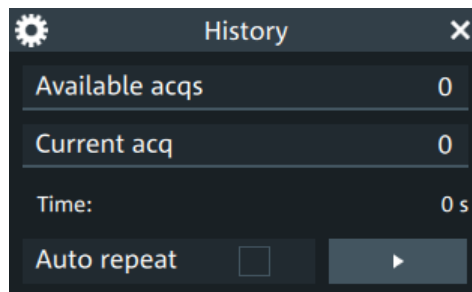

Available acqs.....	174
Current acq.....	174
Time.....	174
Auto repeat.....	174
 Play.....	174

Available acqs

Number of acquisitions that is saved in the memory and available for history viewing. It is also the number of acquisitions in a fast segmentation acquisition series.

Remote command:

[ACQUIRE:AVAILABLE?](#) on page 471

Current acq

Index of the current acquisition, same as [Current acq](#) in the history setup.

Time

Shows the timestamp of the current acquisition. See "[Time stamp](#)" on page 173.

Auto repeat

If selected, the playback of the selected history segments repeats automatically.

Remote command:

[ACQUIRE:HISTORY:REPLAY](#) on page 531

 **Play**

Starts and stops the replay of the history waveforms. See also: "[Player](#)" on page 172.

8.3.4 Using history

You can access the history waveforms in two ways:

- Display a particular acquisition.
- Replay all or a part of the saved waveforms to track the signal run.

To open the history and get information

1. Press the [History] key on the front panel.

A running acquisition is stopped, the history mode is enabled and the quick-access "History" dialog box is displayed. The [History] key lights up as long as the history mode is active.

2. Open the full configuration dialog box:
 - Tap the  icon.
 - Open "Menu" > "Acquisition" dialog > "History" tab.

To display a particular acquisition

You can analyze a selected history waveform, and save it to file.

- ▶ In the quick-access "History" dialog box, enter the number of the required acquisition in the "Current acq" field. The newest acquisition always has the index "0", older acquisitions have a negative index.

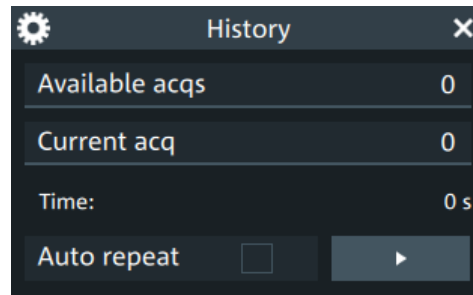

Alternatively, you can configure and start the history display from the "History" configuration dialog box:

1. Open the "History" configuration tab.
2. If the history mode is off (the [History] key is not illuminated), select "Show history".
3. Drag the slider to the required acquisition. The current number is shown in the "Current acq" field.
Alternatively, enter the number of the required acquisition in the "Current acq" field.

To save a single history waveform

1. Select and display the required history waveform as described in ["To display a particular acquisition"](#) on page 175.
2. Save the selected waveform using "Save/Recall" > "Save" tab > "Waveform". For details, see [Chapter 12.2, "Save and recall waveform data"](#), on page 271.

To replay history waveforms

If you want to see the complete acquisition series without any setup, simply tap in the quick-access "History" dialog box. For specific analysis of history data, use the history "Viewer" setup.

1. Open the "History" configuration dialog tab.
2. If the history mode is off (the [History] key is not illuminated), enable "Show history".
3. Tap  to start.

To exit the history

- ▶ Choose one of the following ways:
 - Close the quick-access "History" dialog box.
 - In the "History" configuration tab, disable "Show history".

- Start the acquisition.

8.4 Reference waveforms

You can configure up to four reference waveforms to display stored waveforms. Any active signal, mathematical waveform or spectrum can be stored as a reference waveform. It can then be loaded again later to restore the waveform on the screen.

8.4.1 Working with reference waveforms

Reference waveforms can be displayed in addition to the signal waveforms.

To display a reference waveform

1. In the "Menu" > "Apps" > "General" tab, select "Reference".
Alternatively, press the [Ref] key.
2. Select the tab for the reference waveform that you want to display ("R1/2/3/4").
3. Load a stored reference waveform as described in [To load a reference waveform](#).
Alternatively, select a source to be displayed as a reference:
 - a) In the "Setup" tab, select "Source".
 - b) Select the "Source" from the selection list. The list shows all active waveforms that can be saved as references.
 - c) Tap the "Create/update" button to update the current reference waveform with the source data.
4. Tap the "Show" button.
The reference waveform is displayed on the screen.
5. A reference waveform can have its own scaling settings or it can be scaled according to the source settings. By default, the scaling of the reference waveform is coupled to the source settings. Also, it can be stretched or compressed in vertical and horizontal direction.
If necessary, change the settings on the "Vertical" and "Rescale" tabs of the "Reference Waveform" dialog.
To restore the original settings, tap the "Set to original" in the "Vertical" tab.
For a description of the scaling settings, see [Chapter 8.4.2.4, "Reference waveform rescale"](#), on page 181.

To load a reference waveform

1. Press the [Ref] key.
2. Select the tab for the reference waveform that you want to load ("R1/2/3/4").
3. In the "Setup" tab, select "Recall".
4. Select the file from the file selection dialog box.

5. To load the waveform from the specified file, tap "Open".

The selected waveform is loaded as the specified reference waveform.

8.4.2 Settings for reference waveforms

To compare waveforms and analyze differences between waveforms, you can use up to eight reference waveforms R1 to R8.

Each reference waveform has its own memory on the instrument. You can also save an unlimited number of reference waveforms and load them for further use.

The display of a reference waveform is independent from the display of the source waveform; you can move, stretch and compress the curve vertically and horizontally.

8.4.2.1 Reference waveform setup

Access: [Ref] key > "Setup" tab

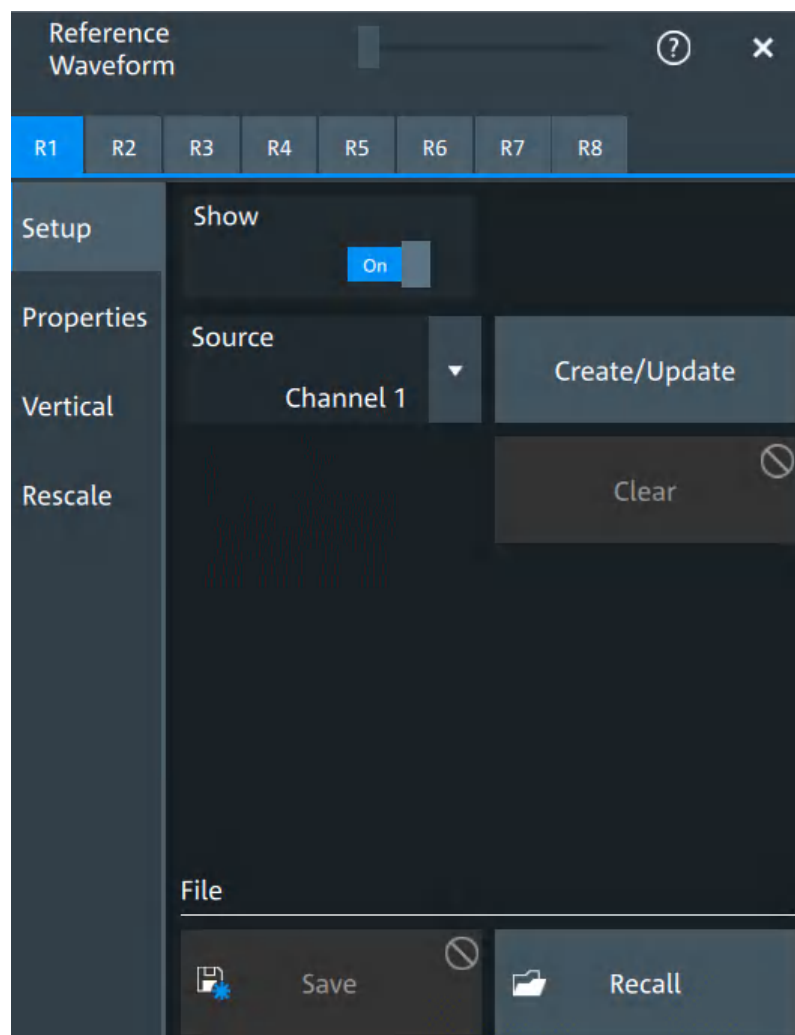

In the "Setup" tab, you select the target reference waveform and its source.

R1/2/3/4

Each tab contains the settings for one of the available reference waveforms.

Show

Enables the display of the reference waveform in the diagram.

Remote command:

`REFCurve<rc>:STAtE` on page 536

Source

Selects the source waveform from the active waveforms, e.g. input channels, math waveforms, or spectrum.

Remote command:

`REFCurve<rc>:SOURce` on page 536

Create/update

Copies the selected source waveform with all its settings to the memory of the reference waveform. If there is a previously defined reference waveform in this memory, it is updated by the current source waveform. If the acquisition is running, the reference waveform is a snapshot.

A progress bar informs you about the process, see "[Progress information](#)" on page 66.

Remote command:

`REFCurve<rc>:UPDate` on page 537

Clear

The selected reference waveform disappears, its memory is deleted.

Remote command:

`REFCurve<rc>:CLear` on page 534

Save

Saves the reference waveform. The complete reference waveform is stored in a REF file and can be reloaded later.

A progress bar informs you about the process, see "[Progress information](#)" on page 66.

If you want to save only a part of the waveform, or need CSV format, use "Menu" key > "Save/Recall" key > "Save" tab > "Waveform".

See also:

- [Chapter 12.2, "Save and recall waveform data"](#), on page 271
- [Chapter 12.2.3, "Waveform export files"](#), on page 274

Remote command:

`REFCurve<rc>:SAVE` on page 536

To abort the saving, use `REFCurve<rc>:ABORt` on page 534.

Recall

Opens a file selection dialog box and loads the selected reference waveform file.

Note that reference waveforms can be loaded only from `.ref` files. Other formats are meant for further processing in other applications.

Remote command:

`REFCurve<rc>:OPEN` on page 535

8.4.2.2 Reference waveform properties

Access: [Ref] key > "Properties" tab



A reference waveform can be scaled, stretched and positioned in the diagram. The "Properties" tab shows the original settings of the reference waveform, which are stored together with the waveform data.

The following settings are displayed:

- Time scale
- Reference point
- Record length, Record length limit
- Position
- Vertical scale
- Offset
- Position
- Enhancement mode
- Interpolation
- Waveform arithmetic

Enhancement mode

The enhancement mode is taken from the source waveform of the reference. The enhancement mode is set automatically by the instrument and depends on the sample rate. As long as the waveform sample rate is not higher than the ADC sample rate, the instrument works automatically in real time mode (RT). At higher waveform sample rates, the instrument changes to interpolated time mode (IT), where interpolation adds waveform points between the captured ADC samples by various mathematical methods, see [Interpolation](#).

Waveform arithmetic

The waveform arithmetic is taken from the source waveform of the reference, and it cannot be changed for the reference. Waveform arithmetic builds the resulting waveform from several consecutive acquisitions of the signal. The arithmetic methods are envelope and average, which are set in the [Acquisition mode](#).

Restore settings

Applies the original settings of the reference waveform to the horizontal and vertical settings of the selected waveform.

Remote command:

[REFCurve<rc>:REStore](#) on page 535

8.4.2.3 Reference waveform vertical

Access: [Ref] key > "Vertical" tab

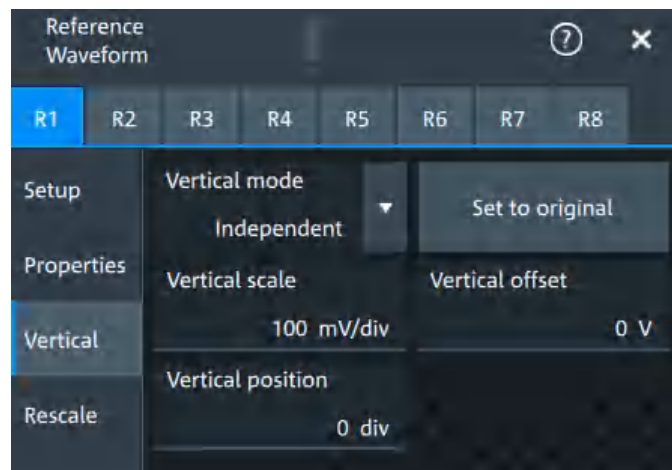
**Mode**

Selects the type of vertical settings:

"Coupled to source" Vertical position and scale of the source are used.

"Independent" Scaling and position can be set specific to the reference waveform.

Remote command:

[REFCurve<rc>:VMODE](#) on page 541

Set to original

Available, if "Mode" = "Independent".

Restores the original vertical settings of the reference waveform (vertical scale, position, and offset).

Remote command:

[REFCurve<rc>:TOORiginal](#) on page 540

Vertical scale

Available, if "Mode" = "Independent".

Sets the vertical scale, which defines the displayed amplitude of the selected waveform.

The unit of the reference is the same as the unit of the source waveform.

Remote command:

[REFCurve<rc>:SCALE](#) on page 537

Vertical offset

The vertical offset moves the reference waveform vertically. Enter a value with the unit of the waveform.

Remote command:

[REFCurve<rc>:OFFSet](#) on page 535

Vertical position

Available, if "Mode" = "Independent".

Moves the reference waveform up or down in the diagram.

Remote command:

[REFCurve<rc>:POSition](#) on page 538

8.4.2.4 Reference waveform rescale

Access: [Ref] key > "Rescale" tab

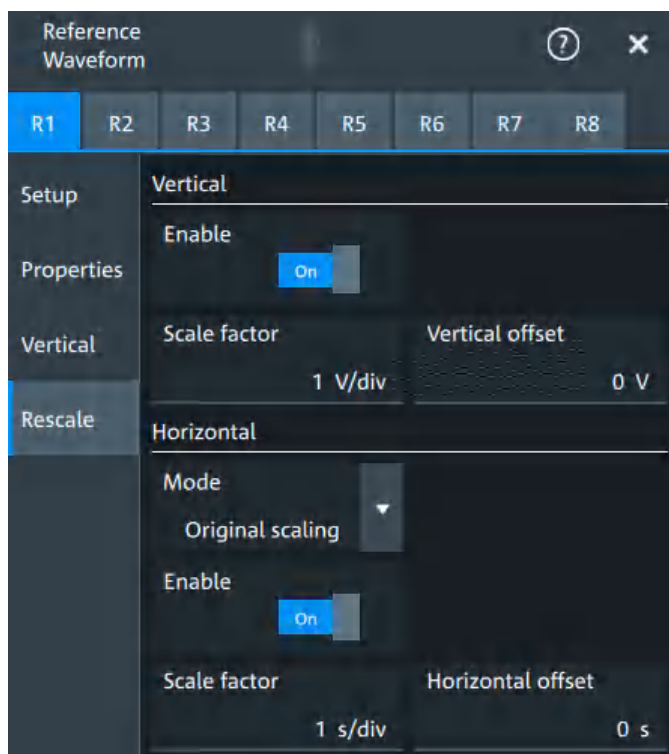

In the "Rescale" tab you can adjust the vertical and horizontal scaling of the reference waveform.

Vertical

Stretching and offset change the display of the waveform independent of the vertical scale and position.

Enable ← Vertical

If enabled, the vertical offset and factor are applied to the reference waveform.

Remote command:

[REFCurve<rc>:RESCale:VERTical:STATe](#) on page 540

Scale factor ← Vertical

Sets the vertical scale factor. A factor greater than 1 stretches the waveform vertically, a factor lower than 1 compresses the curve.

Remote command:

[REFCurve<rc>:RESCale:VERTical:FACTor](#) on page 539

Vertical offset ← Vertical

The vertical offset moves the reference waveform vertically. Enter a value with the unit of the waveform.

Like vertical offset of a channel waveform, the offset of a reference waveform is subtracted from the measured value. Negative values shift the waveform up, positive values shift it down.

Remote command:

[REFCurve<rc>:RESCale:VERTical:OFFSet](#) on page 540

Horizontal

Stretching and offset change the display of the waveform independent of the horizontal settings of the source waveform and of the horizontal diagram settings.

Mode ← Horizontal

Selects the type of horizontal settings:

"Original scaling" Horizontal scaling and reference point of the source waveform are used.

"Adjust to X Axis" The current horizontal settings of the diagram are used.

Remote command:

[REFCurve<rc>:HMODe](#) on page 538

Enable ← Horizontal

If enabled, the horizontal offset and factor are applied to the reference waveform.

Remote command:

[REFCurve<rc>:RESCale:HORizontal:STATe](#) on page 539

Scale factor ← Horizontal

Sets the horizontal scale factor. A factor greater than 1 stretches the waveform horizontally, a factor lower than 1 compresses the curve.

Remote command:

[REFCurve<rc>:RESCale:HORizontal:FACTor](#) on page 538

Horizontal offset ← Horizontal

Moves the waveform horizontally. Enter a value with a time unit suitable for the time scale of the diagram.

Positive values shift the waveform to the right, negative values shift it to the left.

Remote command:

[REFCurve<rc>:RESCale:HORizontal:OFFSet](#) on page 539

9 Measurements

Using the R&S MXO 5 you can perform and display different measurements simultaneously, based on the active signal or math waveforms. The color of the results in the result table corresponds with the source waveform color.

9.1 Cursor measurements

- [Cursors and results of cursor measurements](#)..... 184
- [Using cursors](#)..... 185
- [Settings for cursor measurements](#)..... 187

9.1.1 Cursors and results of cursor measurements

Cursor measurements determine the results at the current cursor positions. The cursors can be positioned manually, or can be configured to follow the waveform. You can measure on one waveform, or on two different waveforms (sources).

Up to 4 cursor sets can be configured and displayed. Each cursor set consists of a pair of horizontal or vertical cursors, or both. Cursor lines can be coupled so that the initially defined distance is always maintained.

The cursors are displayed in the diagrams of the source waveform only, or in all diagrams. For each measurement, labels can be defined for the cursors. By default, the cursors are labeled as Cu1.1 and Cu1.2.

How to set up cursor measurements is described in [Chapter 9.1.2, "Using cursors"](#), on page 185. The [Chapter 9.1.3, "Settings for cursor measurements"](#), on page 187 provides a detailed description of all settings.

For details on using the result table, see [Chapter 4.9, "Displaying results"](#), on page 62.

9.1.1.1 Cursor measurements on time-based waveforms

The cursor for measurement on time-based waveforms returns the following results. The results are displayed automatically when a cursor measurement is enabled.

C1	X1	-50 ns	X2	14.226 ns	Y1: 0.5 mV	Y2: 1.5 mV
	dx:	64.226 ns	1/dx:	15.5700 MHz	dy:	1 mV
					dy/dx:	15.2162 kV...

Label	Description
"X1, X2"	Time at the position of the vertical cursors.
"Y1, Y2"	Vertical values of the waveform at the position of the horizontal cursors in V or A.
"dx"	Difference between the vertical cursor (time) values

Label	Description
"1/dx"	Inverse time difference
"dy"	Difference between the horizontal cursor values
"dy/dx"	Slope of the waveform between the cursors (if measured on one source)

9.1.2 Using cursors

You can start cursor measurements by using the toolbar, or using the [Cursor] key. For detailed configuration, use the "Cursor" dialog box.

9.1.2.1 Starting a simple cursor measurement

To add cursors using the toolbar

1. Tap the "Add cursor" icon on the toolbar.



2. Select the channel that you want to apply the cursor to.
Tap the waveform that you want to measure. Alternatively, you can draw a rectangle in the diagram to position the cursor lines.

The cursor lines appear and the cursor results are displayed in a table or result box.

To display cursors using the [Cursor] key

1. Select the waveform that you want to measure.
2. Press the [Cursor] key.

The cursor lines and the measurement results are displayed.

9.1.2.2 Configuring a cursor measurement

To modify the position of the cursor lines, you can drag the lines on the screen. In addition, various settings are possible to refine the measurement.

The complete configuration of cursor measurements is provided in the "Cursor" dialog.

1. To open the "Cursor" dialog, use one of these ways:
 - Open the "Menu" > "Cursor".
 - Press the [Cursor] key.
 - Double-tap in the results table (but not on a result).
2. Select the "Setup" tab.
3. Select the subtab for the cursor set that you want to use.

4. Select the "Source" - the measured waveform. You can select any input channel, or various other active waveforms. Available sources are shown in the source list.
5. If necessary, enable the "Second source". Select a waveform for "Source 2".
6. Select the "Type": X (vertical), Y (horizontal), or XY (both).
7. Define the position of the cursors:
 - a) To define exact positions of the cursor lines, enter the X-position for each vertical cursor and the Y-position for each horizontal cursor.
If it is not possible to set horizontal cursors, disable "Track waveform".
 - b) To position the horizontal cursors automatically, select "Track waveform".
In this case, Cu 1.1 indicates the current maximum, Cu 1.2 indicates the current minimum. If both horizontal and vertical cursors are displayed, the horizontal cursors are placed at the crossing points of the vertical cursors with the waveform. Adjust the vertical cursors manually, and the horizontal cursors follow.
8. To display the cursor in all diagrams that are in the same domain as the selected source (time or spectrum), enable "Show in all diagrams" in the "Advanced" tab.
9. To set the cursors for a spectrum measurement to peak values, select the "Peak search" tab.
Tap one of the buttons to place the cursors on the selected peak value. For details, see [Chapter 9.1.3.3, "Peak search tab"](#), on page 191.
10. Tap the "Type" button in the "Setup" tab to activate the cursor measurement.
The cursors lines and the results are displayed. For details on cursor measurement results, see [Chapter 9.1.1, "Cursors and results of cursor measurements"](#), on page 184.

9.1.2.3 Configuring the cursor display

By default, the cursors are displayed as lines in the diagrams and labeled according to the syntax: Cu<cursor set number>.<1|2>

For example, the cursors for the cursor set 2 are labeled 2.1 and 2.2. The horizontal and the vertical cursors lines have the same labels.

You can change the default cursor display and labels.

To set the cursor style

1. Press the [Cursor] key.
2. Select the subtab for the cursor set you want to configure.
3. Select the "Setup" tab.
4. Select the "Cursor style". See also: ["Cursor style"](#) on page 188.

To add labels to cursor lines

1. Press the [Cursor] key.
2. Select the subtab for the cursor set you want to configure.
3. Select the "Advanced" tab.
4. Enter a label for "Vertical cursor 1", "Vertical cursor 2", "Horizontal cursor 1", "Horizontal cursor 2".
5. Enable "Show label".

9.1.3 Settings for cursor measurements

Cursor measurements are configured in the "Cursor" dialog box.

9.1.3.1 Setup tab

The "Setup" tab contains the settings for cursor measurements.

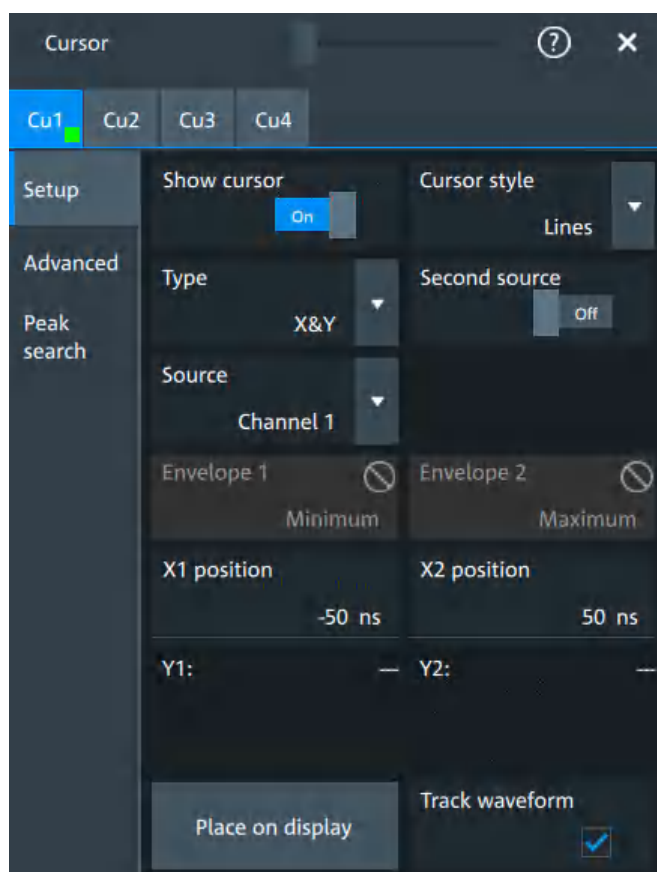

Cu1/Cu2

The settings for each cursor measurement (or cursor set) are configured on separate tabs. For each cursor set, a horizontal pair of cursors, a vertical pair of cursors, or both can be displayed.

Show cursor

Enables the selected cursor measurement.

Remote command:

`CURSor<cu>:STATe` on page 579

Cursor style

Defines how the cursor is displayed in the diagram.

"Lines" The cursors are displayed as lines.

"Line & Rhombus"

The cursors are displayed as lines. The intersections of the cursors with the waveforms are displayed by rhombus-shaped points.

"VLine & Rhombus"

Vertical line and rhombus: the cursors are displayed as vertical lines. The intersections of the cursors with the waveforms are displayed by rhombus-shaped points.

"Rhombus"

The intersections of the cursors with the waveforms are displayed by rhombus-shaped points.

Remote command:

`CURSor<cu>:STYLe` on page 587

Type

Defines the cursor type to be used for the measurement.

"X" (vertical cursors)

Both vertical cursor lines are set automatically to the trigger position, and you can reposition them manually.

"Y" (horizontal cursors)

Horizontal cursors are positioned automatically along the waveform and can be adjusted manually.

"X&Y" (both vertical and horizontal cursors)

Horizontal cursors are positioned automatically along the waveform and vertical cursors are set to the trigger position. You can reposition all cursor lines manually.

Remote command:

`CURSor<cu>:FUNctioN` on page 579

Second source, Source 2

Enables and selects a second source for the cursor measurements. If enabled, the second cursor lines Cu2 measure on the second source. Using a second source, you can measure differences between two channels with cursors.

Remote command:

[CURSor<cu>:USSource](#) on page 580

[CURSor<cu>:SSource](#) on page 580

Source

Defines the source of the cursor measurement. Any of the input signal, math or reference waveforms can be selected.

Remote command:

[CURSor<cu>:SOURce](#) on page 579

Envelope, Envelope 2

Define which horizontal cursor is positioned to the maximum and which to the minimum envelope values.

Envelope selection is effective under the following conditions:

- The acquisition mode of the cursor source waveform is set to envelope, see [Acquisition mode](#).
- [Track waveform](#) is enabled.
- Both horizontal and vertical cursors are enabled ([Type](#) = "X&Y").

"Minimum" The horizontal cursor is set to the crossing point of the vertical cursor with the minimum waveform envelope.

"Maximum" The horizontal cursor is set to the crossing point of the vertical cursor with the maximum waveform envelope.

Remote command:

[CURSor<cu>:X1ENvelope](#) on page 583

[CURSor<cu>:X2ENvelope](#) on page 583

X1 position, X2 position

Define the left and right position of the vertical cursors.

Remote command:

[CURSor<cu>:X1Position](#) on page 580

[CURSor<cu>:X2Position](#) on page 581

Y1 position, Y2 position

Define the upper and lower position of the horizontal cursor lines.

If [Track waveform](#) is enabled, the user setting is disabled and the measurement results are displayed in the result table.

Remote command:

[CURSor<cu>:Y1Position](#) on page 581

[CURSor<cu>:Y2Position](#) on page 581

Track waveform

The horizontal cursors track the waveform. The first cursor line indicates the current vertical minimum, and the second cursor line indicates the maximum. If the waveform changes, e.g. during a running measurement, the cursors move along with it.

If both horizontal and vertical cursors are displayed, the horizontal cursors are positioned to the crossing points of the vertical cursors with the waveform. The measurement results are displayed in the cursor result box.

Remote command:

[CURSor<cu>:TRACking\[:STATe\]](#) on page 582

Place on display

Resets the cursors to their initial positions. Reset is helpful if the cursors have disappeared from the display or need to be moved for a larger distance.

9.1.3.2 Advanced settings

Access: Cursor key > "Advanced" tab

The settings in the "Advanced" cursor tab configure the behavior and display of cursor lines, and labels for the lines.

The cursor style and position of the measurement results is defined in the "Settings" > "Appearance" > "Cursor" dialog box.

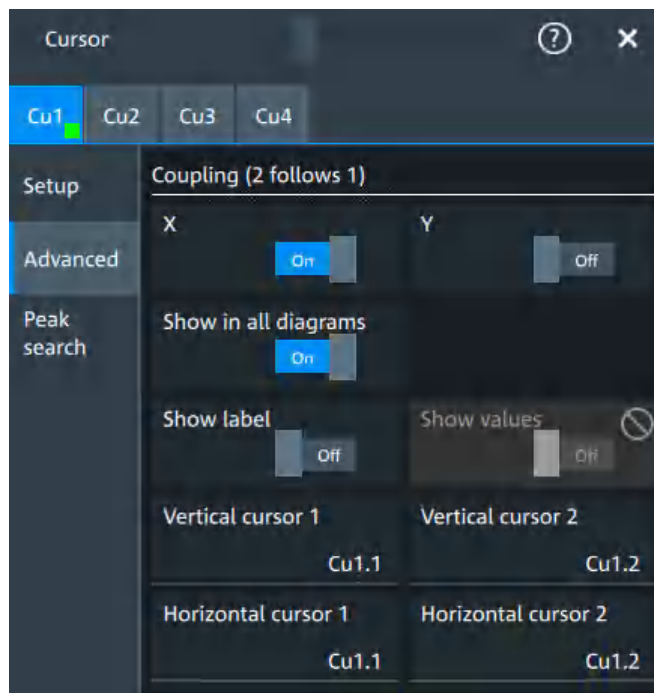

X, Y

Couple the horizontal or vertical cursor lines so that the distance between the two lines remains the same if one cursor is moved. "X" couples the vertical cursor lines, and "Y" couples the horizontal cursor lines.

Remote command:

[CURSor<cu>:XCoupling](#) on page 582

[CURSor<cu>:YCOupling](#) on page 583

Show in all diagrams

Shows the enabled cursor measurements in all active diagrams of the same (time/spectrum) domain.

Remote command:

`CURSor<cu>:SIAD` on page 582

Show label

Shows the cursor labels in the diagram.

Remote command:

`CURSor<cu>:LABel` on page 582

Show values

Displays the values of the labels.

Vertical cursor 1, Vertical cursor 2

Defines a label to be displayed with the vertical cursors.

By default, the cursors are labeled as Cu1.1, Cu1.2, Cu2.1, Cu2.2.

Horizontal cursor 1, Horizontal cursor 2

Defines a label to be displayed with the horizontal cursors.

9.1.3.3 Peak search tab

Access: [Cursor] key > "Peak search" tab

The settings on this tab are only available in spectrum mode, i.e. the source of the cursor measurement is a spectrum. In this case, the cursors can indicate the results of a peak search on the waveform. You can define which peaks the instrument determines by defining the noise reject settings.

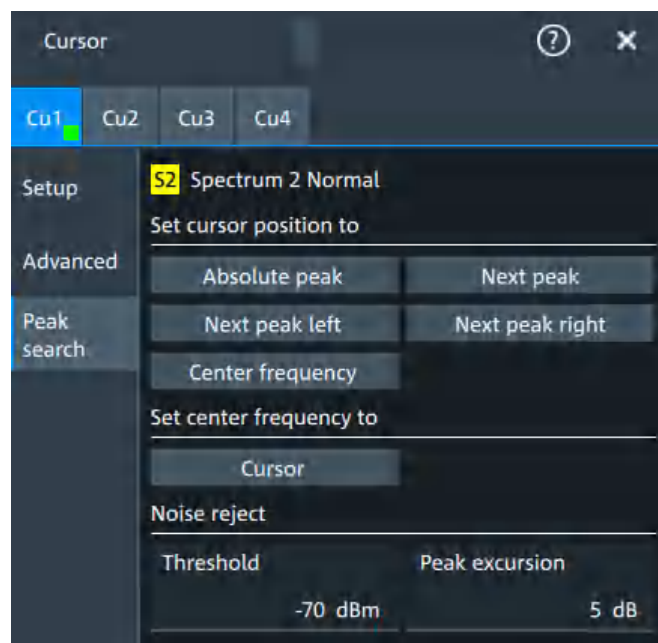

Absolute peak

Sets both cursors to the absolute peak value.

Remote command:

[CURSor<cu>:MAXimum\[:PEAK\]](#) on page 586

Next peak

Cursor 2 is set to the next smaller absolute peak from the current position.

Remote command:

[CURSor<cu>:MAXimum:NEXT](#) on page 587

Next peak left

Cursor 2 is set to the next peak to the left of the current position.

Remote command:

[CURSor<cu>:MAXimum:LEFT](#) on page 586

Next peak right

Cursor 2 is set to the next peak to the right of the current position.

Remote command:

[CURSor<cu>:MAXimum:RIGHT](#) on page 586

Center frequency

Sets the vertical cursor line Cu1 to the center frequency.

Remote command:

[CURSor<cu>:FFT:TOCenter](#) on page 586

Set center frequency to

Sets the center frequency to the frequency value that is measured at cursor line Cu1.

Remote command:

[CURSor<cu>:FFT:SETCenter](#) on page 585

Threshold

Sets an absolute threshold as an additional condition for the peak search. Only peaks that exceed the threshold are detected.

This setting is only available for spectrum waveforms. It is valid for cursor measurements, spectrum measurements and peak search.

Remote command:

[CALCulate:SPECTrum<sp>:THReshold](#) on page 594

[CURSor<cu>:THReshold](#) on page 587

Peak excursion

Defines a relative threshold, the minimum level value by which the waveform must rise by to be considered as a peak. For the peak to be considered, the excursion threshold must be met both on the left and the right sides of the peak.

To avoid identifying noise peaks, enter a peak excursion value that is higher than the noise levels.

This setting is only available for spectrum waveforms. It is valid for cursor measurements, spectrum measurements and peak search.

Example:

In the figure below, 2 peaks are shown, that rise above the defined "Threshold". Peak 1 fulfills the defined "Peak excursion" value and is counted as a peak. Peak 2 does not fulfill the defined "Peak excursion" value on the right and is not counted as a peak.

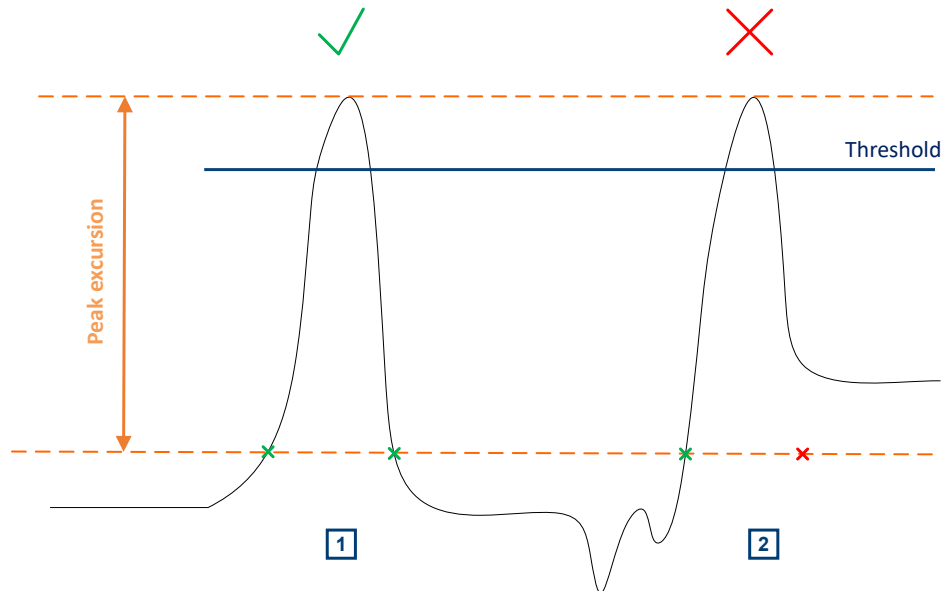

Remote command:

[CALCulate:SPECTrum<sp>:PEXCursion](#) on page 594

[CURSor<cu>:PEXCursion](#) on page 587

9.2 Automatic measurements

You can perform up to 24 different measurements simultaneously.

There are two methods to start a measurement, each with slightly different effects:

- Using the "Measure" icon on the toolbar:
See: ["To start a measurement using the toolbar icon"](#) on page 193.
- Pressing the [Measure] key on the front panel, or using the "Measurement" menu.
See: ["To configure measurements in the Measurement dialog"](#) on page 194.

To start a measurement using the toolbar icon

1. Tap the "Measure" icon on the toolbar.



The measurement overlay menu opens.



2. Select the "Category".
3. Tap on the measurements that you want to perform. You can scroll left and right through the measurement list, to view all available measurements for the selected "Category".
4. Select the source that you want to apply the measurement on.
5. If needed, click on "Setup" to configure further measurements.
The measurement results are displayed.

To configure measurements in the Measurement dialog

1. Select the waveform on the screen.
2. Press the [Measure] key.
The measurement for the selected waveform is enabled using the next available measurement configuration. The measurement results are displayed.

To add a new measurement

1. Press the [Measure] key, to open the measurement dialog.
2. In the "Setup" tab, press "Add".
A dialog opens to select the measurements.
3. Select the "Source" for the measurement.
4. Select the "Category" of the measurement that you want to add, e.g. "Horizontal".
All available measurements for this category are displayed. For more details on the available measurement types, see [Chapter 9.2.4, "Measurement types"](#), on page 202.
5. Tap on a measurement from the list to enable it.
Selected measurements are marked with a blue check mark in their checkbox.

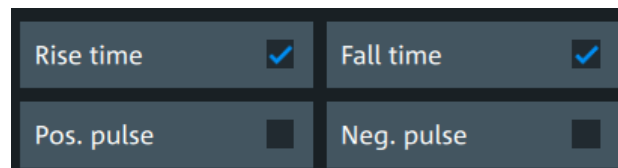

6. The measurements of some categories are listed on several tabs. To switch between the tabs, press the points at the bottom of the list.

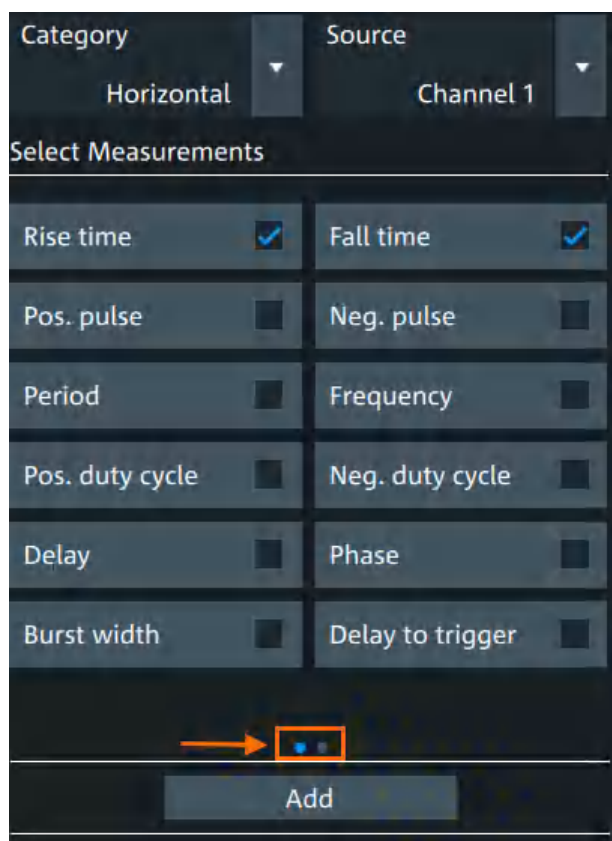

7. Tap "Add" to add the selected measurements.
All selected measurements are enabled.

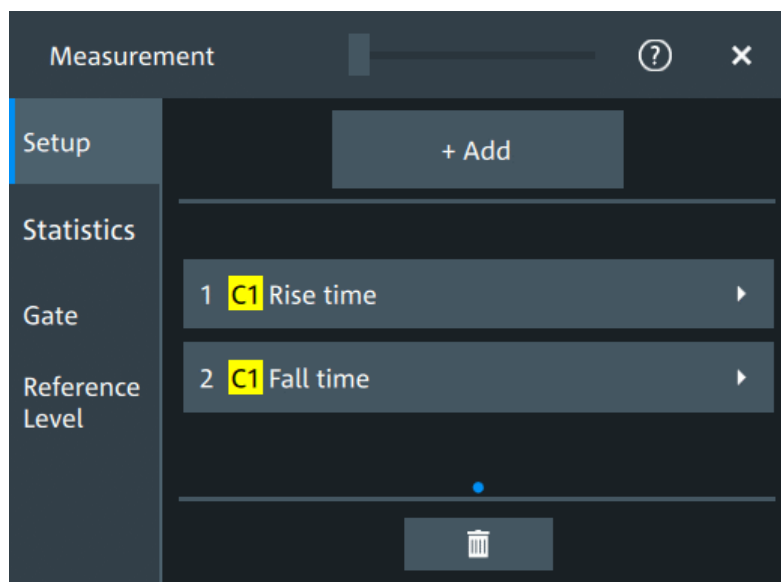

To delete a measurement

1. Press the [Measure] key, to open the measurement dialog.

- In the "Setup" tab, press .

A delete icon appears in the selection button of each measurement.

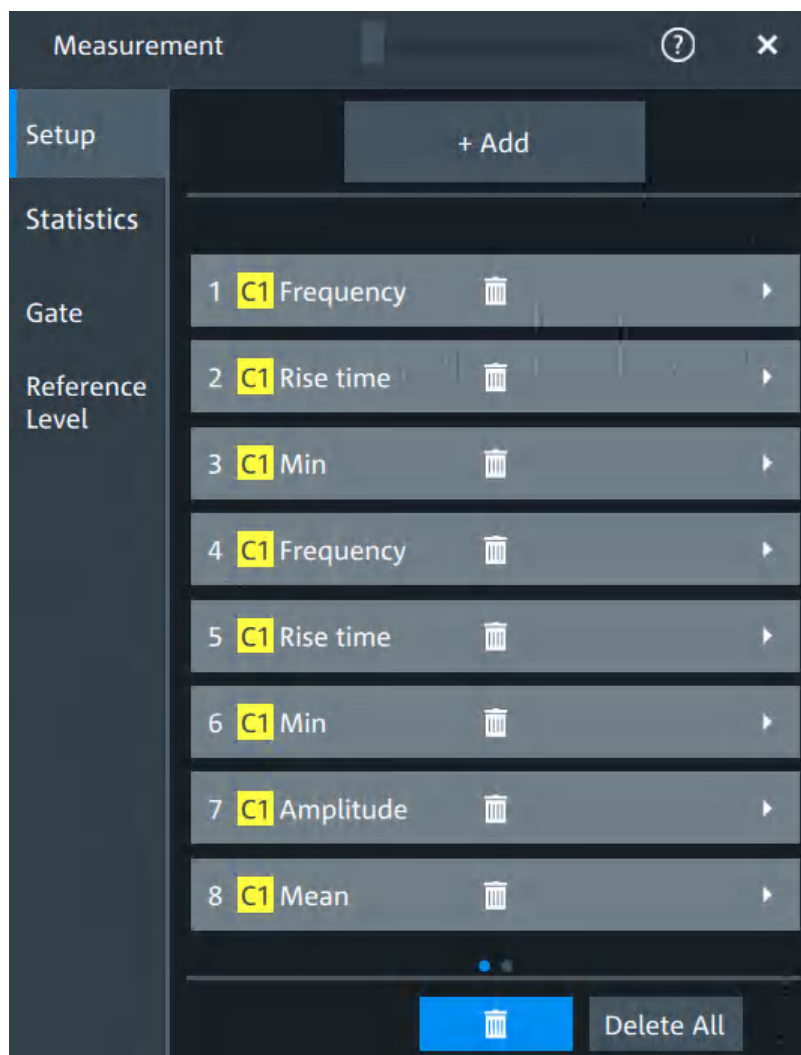

- Tap on the button of the measurement that you want to delete. Alternatively, tap "Delete All" to delete all measurements.

9.2.1 Measurement results

The measurement results are shown in a table below the grid.

Measure	Statistics
1 C1 Amp.:	3.418 mV
2 C1 Min:	-2.443 mV
3 C1 Max:	3.054 mV
4 C1 PTP:	5.497 mV

-	No valid waveform is available, for example, if the source waveform is off.
---	---

Statistics

In addition to the current measurement results, you can enable a statistic evaluation. It returns the current, minimum and maximum measurement values, the average and standard deviation, and the number of measured waveforms. The results are shown in a separate tab below the grid. If the cursor measurement is active simultaneously, its results are shown beside the statistics results.

Measure	Current	Max	Min	Mean	RMS	σ (5-dev)	Event count	Wave count
1 C1 Amp.	4.88 mV	7.81 mV	1.46 mV	3.8 mV	3.91 mV	938.01 μ V	2847	2847
2 C1 Min	-2.44 mV	-1.71 mV	-4.76 mV	-2.69 mV	2.71 mV	365.09 μ V	2283	2283
3 C1 Max	3.66 mV	5.25 mV	2.32 mV	3.29 mV	3.31 mV	356.83 μ V	2283	2283
4 C1 PTP	6.11 mV	8.18 mV	4.76 mV	5.98 mV	6 mV	480.81 μ V	2283	2283

9.2.2 Gate settings for measurements

Gate areas limit the measurement to a user-defined range of the waveform. The gate settings are defined on the "Gate" tab.

You can define up to 8 separate gates for the measurement analysis. Then, you assign the measurements to the gates.

Access: [Measure] > "Gate" tab

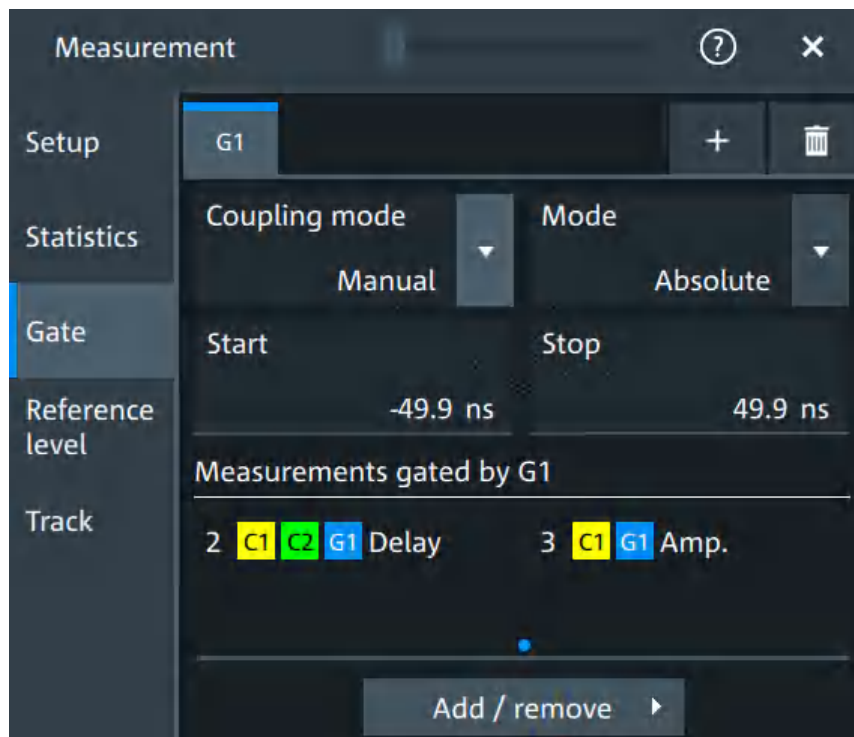

+ Add

Activates a new gate.

Remote command:

[GATE<g>:ENABle](#) on page 568

Coupling mode

The gate coupling mode selects how the gate area is defined.

"Manual"	Manually define the gate with a user-defined start and stop values.
"Cursor"	Cursor coupling is available if a cursor is defined. The gate area is defined by the cursor lines of an active cursor measurement. If several cursor measurements are enabled, select the "Cursor" to be used for gating. The start and stop values of the gate are adjusted to the values of the cursor line positions. The measurement is limited to the part of the waveform between the cursor lines.
"Zoom"	Zoom coupling is available if a zoom is defined. The gate area is defined identically to the zoom area - if you change the zoom, the gate changes as well. If several zoom diagrams are defined, select the "Zoom" diagram to be used for gating. The start and stop values of the gate are adjusted to the values of the zoom positions.
"Spectrum"	Spectrum coupling is available if a spectrum is enabled. If several spectrums are enabled, select the "Spectrum" diagram to be used for gating.

Remote command:

[GATE<g>:GCOupling](#) on page 568

[GATE<g>:CURSor](#) on page 569

[GATE<g>:ZDIagram](#) on page 569

Mode

Selects if the gate settings are configured using absolute or relative values.

"Absolute"	The gate is defined by absolute start and stop values with "Start" and "Stop".
"Relative"	The gate's start and stop values are defined by a percentage of the value range with "Relative start" and "Relative stop".

Remote command:

[GATE<g>:MODE](#) on page 569

[GATE<g>:ABSolute:START](#) on page 570

[GATE<g>:ABSolute:STOP](#) on page 570

[GATE<g>:RELative:START](#) on page 570

[GATE<g>:RELative:STOP](#) on page 570

Measurements gated by G<x>

Displays all active measurements that are limited by the gate.

Remote command:

[MEASurement<mg>:GATE](#) on page 563

Add

Opens a dialog to select the measurements to be gated by the active gate. You can select from the list of all enabled measurements.

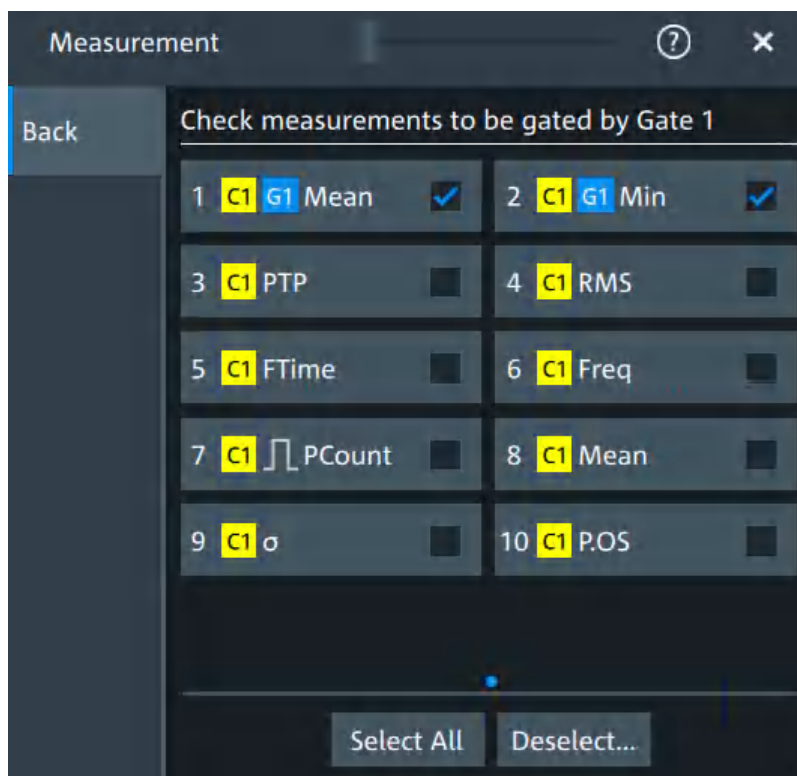

Figure 9-1: Automatic measurements gate dialog

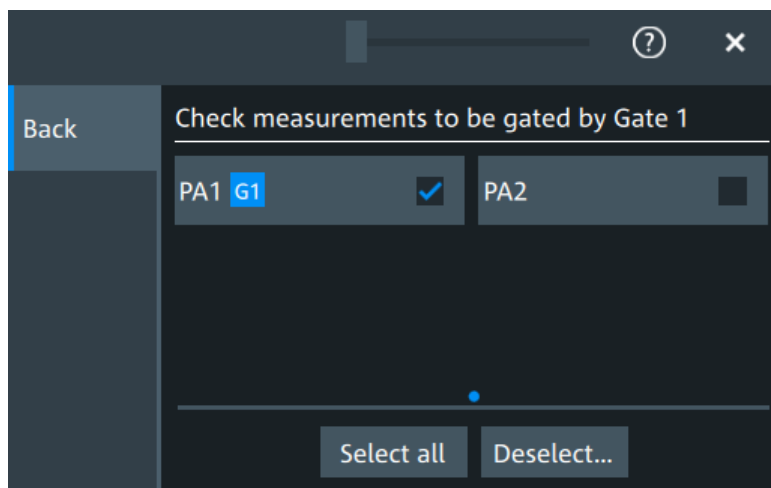

Figure 9-2: Power quality analysis gate dialog

9.2.3 Reference level

Some measurements require reference levels to obtain the measurement points, e.g. time measurements or pulse count. You can define 8 sets of reference levels. During configuration of the measurement, you select which set of reference levels is used.

Access: [Measure] > "Reference level" tab

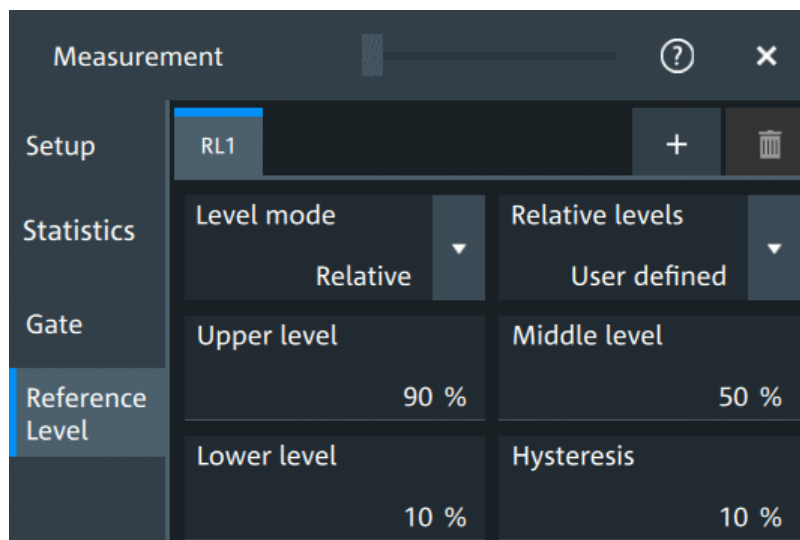

Figure 9-3: Relative reference level

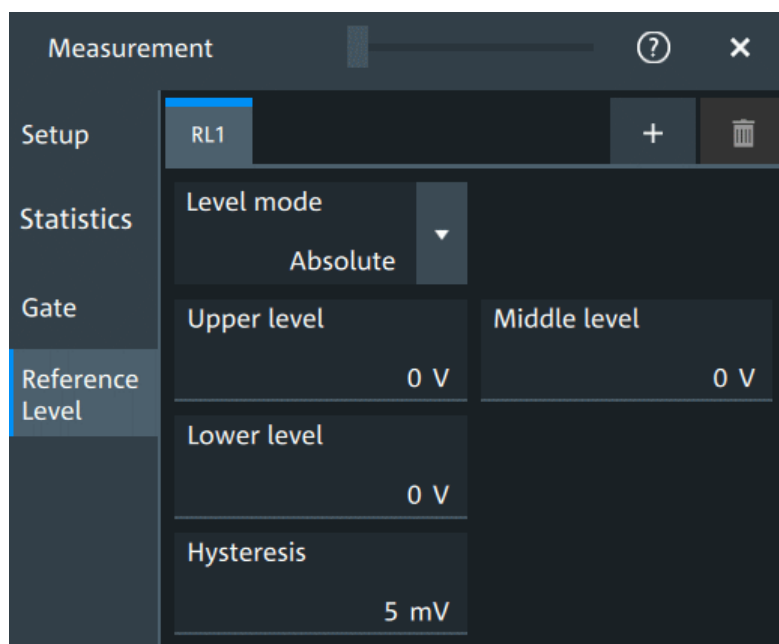

Figure 9-4: Absolute reference level

RLx

Select the correct reference level tab before you enter the settings.

You can add up to 8 reference levels.

Remote command:

`REFLevel<rl>:ENABLE` on page 571

Level mode

Defines if the reference level is set in absolute or relative values.

Remote command:

[REFLevel<rl>:LMODE](#) on page 571

Absolute Level mode

In the absolute mode, the reference values are set as voltages, in absolute values.

Upper level, Middle level, Lower level ← Absolute Level mode

Sets the low, middle and upper reference signal levels.

Remote command:

[REFLevel<rl>:ABSolute:LLEVEL](#) on page 572

[REFLevel<rl>:ABSolute:MLEVEL](#) on page 572

[REFLevel<rl>:ABSolute:ULEVEL](#) on page 572

Relative Level mode

In the relative mode, the reference values are set as percentages of the signal amplitude.

Relative levels ← Relative Level mode

Selects the lower, middle and upper reference levels, defined as percentages of the signal amplitude.

Available relative levels:

- 5/50/95
- 10/50/90
- 20/50/80
- User defined: Enter "Upper level", "Middle level", and "Lower level".

For example, for "5/50/95" the levels are set to the following values:

- Lower level = 5% of the signal amplitude
- Middle level = 50% of the signal amplitude
- Upper level = 95% of the signal amplitude

Remote command:

[REFLevel<rl>:RELative:MODE](#) on page 574

Upper level, Middle level, Lower level ← Relative Level mode

Define the reference levels in percent, if "Level mode" is set to "User-defined".

Remote command:

[REFLevel<rl>:RELative:LOWer](#) on page 573

[REFLevel<rl>:RELative:MIDDLE](#) on page 573

[REFLevel<rl>:RELative:UPPer](#) on page 574

Hysteresis

Defines a hysteresis for the middle reference level. A rise or fall from the middle reference value that does not exceed the hysteresis is rejected as noise.

Remote command:

[REFLevel<rl>:ABSolute:HYSTeresis](#) on page 571

[REFLevel<rl>:RELative:HYSTeresis](#) on page 573

9.2.4 Measurement types

The R&S MXO 5 provides many measurement types to measure time and amplitude characteristics, and to count pulses and edges.

9.2.4.1 Horizontal measurements (time)

Meas. type	Symbol	Description/result
Rise Time	RTime	Rise time of the first rising edge, the time it takes the signal to rise from the lower reference level to the upper reference level.
Fall Time	FTime	Fall time of the first falling edge, the time it takes the signal to fall from the upper reference level to the lower reference level.
Pos. pulse	PPuls	Duration of the first positive pulse: time between a rising edge and the following falling edge measured on the middle reference level.
Neg. pulse	NPuls	Duration of the first negative pulse: time between a falling edge and the following rising edge measured on the middle reference level.
Period	T in s	Time of the first period, measured on the middle reference level. The measurement requires at least one complete period of the signal.
Frequency	Freq	Frequency of the signal, reciprocal value of the measured first period.
Delay	Delay	Time difference between two slopes of the same or different waveforms, measured on the middle reference level. A negative result indicates that the slope of the second source comes before the slope of the first source.
Phase	Phs in °	Phase difference between two waveforms, measured on the middle reference level.
Burst width	Bst	Duration of one burst, measured on the middle reference level from the first edge to the last edge.
Setup Hold Setup/Hold time	Setup Hold SHT	Setup and Hold time measurements with positive and/or negative clock edge, measured on the middle reference level.
Setup/Hold ratio	SHR	Setup/Hold ratio measurement with positive and/or negative clock edge.
Delay to trigger	Dly Trg in s	Time between the trigger point and a selectable edge, measured on the middle reference level. If the edge is to the left of the trigger (before trigger), the result is negative.
Slew rate rising	SrateRis- ing	Steepness of the first rising edge, measured between the lower and the upper reference levels. $Slewrt = \Delta V / \Delta t$
Slew rate falling	SrateFal- ling	Steepness of the first falling edge, measured between the upper and the lower reference levels. $Slewrt = \Delta V / \Delta t$

9.2.4.2 Vertical measurements (amplitude)

The unit of most amplitude measurement results depends on the measured source.

Meas. type	Symbol	Description/result
High	High	High level of the displayed waveform - the upper maximum of the sample distribution, or the mean value of the high level of a square wave without overshoot. The measurement requires at least one complete period of the signal.
Low	Low	Low level of the displayed waveform - the lower maximum of the sample distribution, or the mean value of the low level of a square wave without overshoot. The measurement requires at least one complete period of the signal.
Amplitude	Amp	Difference between the top level and the base level of the signal. The measurement requires at least one complete period of the signal.
Max	Max	Maximum value within the displayed waveform.
Min	Min	Minimum value within the displayed waveform.
Peak to peak	PTP	Difference of maximum and minimum values.
Mean	Mean	Arithmetic average of the complete displayed waveform. $\text{Mean} = \frac{1}{N} \sum_{k=1}^N x_k$
RMS	RMS	RMS (root mean square) value of the voltage of the complete displayed waveform. $\text{RMS} = \sqrt{\frac{1}{N} \sum_{k=1}^N x_k^2}$
σ (S-dev/AC-RMS)	σ (S-dev/AC-RMS)	Standard deviation of one cycle, usually of the first, left-most signal period.
Crest factor	Crest	The crest factor is also known as peak-to-average ratio. It is the maximum value divided by the RMS value of the displayed waveform. $\text{Crest} = \frac{\text{Max} x_k }{\text{RMS}}$
Pos. Overshoot Neg. Overshoot	P.OS N.OS	Overshoot of a square wave after a rising or falling edge. It is calculated from measurement values top level, base level, local maximum, local minimum, and amplitude. $\text{Over}_+ = \frac{\text{Max}_{\text{local}} - \text{Top}}{\text{Amplitude}} \cdot 100\%$ $\text{Over}_- = \frac{\text{Base} - \text{Min}_{\text{local}}}{\text{Amplitude}} \cdot 100\%$

9.2.4.3 Area and cycle measurements

All cycle measurements require that at least one complete period of the signal is acquired.

Meas. type	Symbol	Description/result
Area	Area	Area between the waveform and a reference level (X_{Ref}). $A_{Ref} = \frac{T_{Eval}}{N_{Eval}} \cdot \sum_{i=1}^{N_{Eval}} (x(i) - X_{Ref})$ <p>T_{Eval}: Evaluation time, time of a full waveform or limited by a gate</p>
Cycle area	CArea	Area between the waveform and a reference level measured for one period, see also "Area" measurement.
Pos duty cycle	PDCyc	Width of the first positive pulse in relation to the period in %. $R_{PosCyc} = \frac{T_{PosPulse}}{T_{Period}} \cdot 100\%$
Neg duty cycle	NDCyc	Width of the first negative pulse in relation to the period in %. $R_{NegCyc} = \frac{T_{NegPulse}}{T_{Period}} \cdot 100\%$
Cycle mean	CMean	Mean value of one cycle
Cycle RMS	CRMS	RMS (root mean square) value of one cycle
Cycle σ (S-dev)	Cyc σ	Standard deviation of one cycle
Cycle max	CMax	Maximum value of one cycle
Cycle min	CMin	Minimum value of one cycle
Cycle peak to peak	CPTP	Peak-to-peak value of one cycle: the difference of CMax and CMin

9.2.4.4 Counting

Meas. type	Symbol	Description/result
Pulse count	PCount	The number of positive or negative pulses of the waveform, or of both positive and negative pulses. <p>The mean value of the signal is determined. If the signal passes the mean value, an edge is counted. A positive pulse is counted if a rising edge and a following falling edge are detected. A negative pulse is counted if a falling edge and a following rising edge are detected.</p>
Edge count	EdCo	The number of positive or negative edges, or of both positive and negative edges. <p>The instrument determines the mean value of the signal and counts an edge every time the signal passes the mean value.</p>

9.2.5 Settings for measurements

In the "Measurement" dialog, you can enable measurement and define their settings.

9.2.5.1 Setup tab

Access: "Menu" > "Measurement" > "Setup" tab.

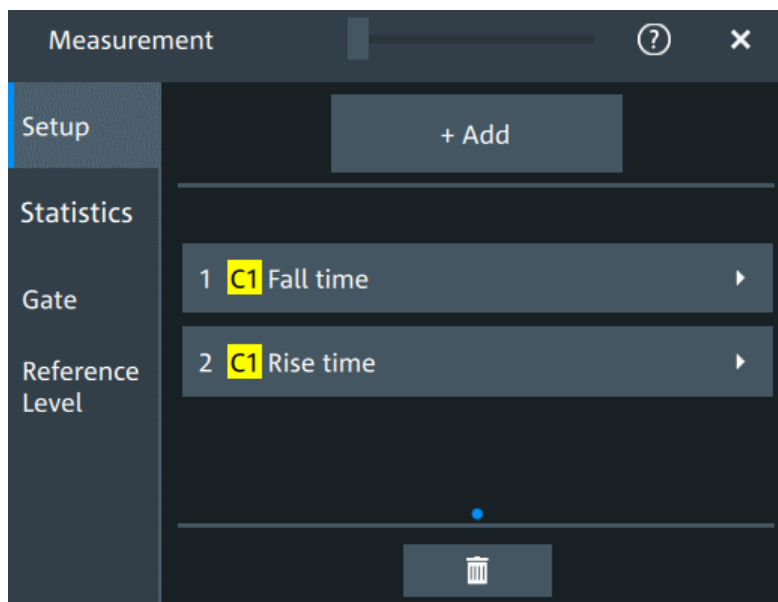

Add

Opens a dialog to select the measurements.

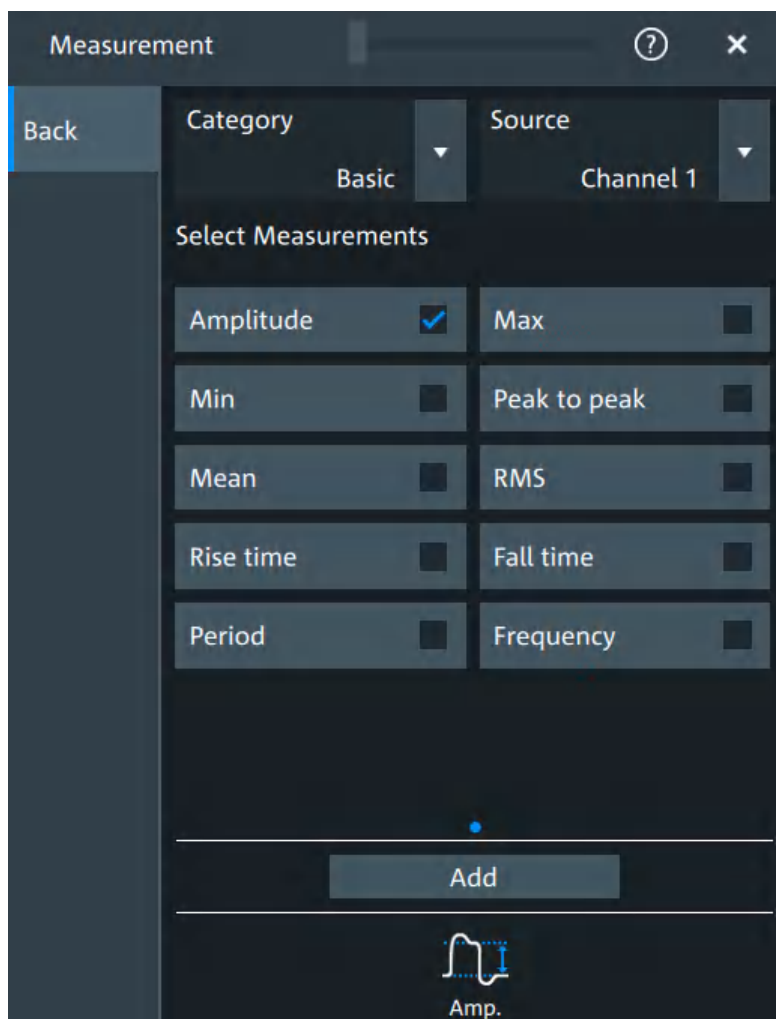
**Category ← Add**

Selects the measurement category. Some measurements are listed in more than one category.

For an overview of the available categories and measurements, see [Chapter 9.2.4, "Measurement types"](#), on page 202.

Source ← Add

Sets the source of the measurement.

Remote command:

[MEASurement<mg>: SOURce](#) on page 558

Delete icon

Enables the removal of measurements. You can delete a single measurement by tapping on the delete icon next to it.

You can also delete all current measurements with "Delete All".

9.2.5.2 Measurement type specific settings

You can define additional parameters for some measurements.

Access: "Menu" > "Measurement" > "Setup" tab > Add measurement > Select measurement

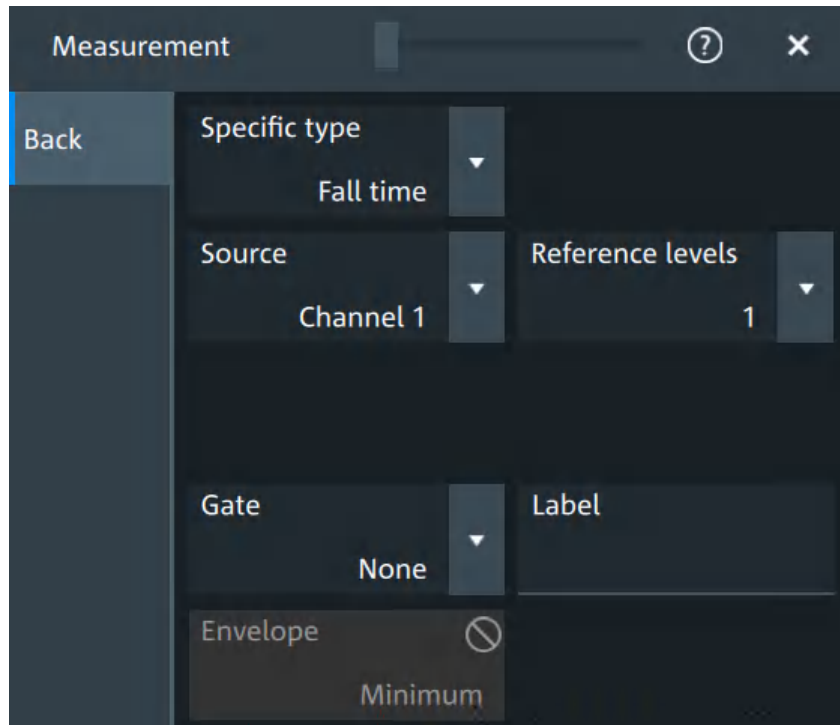

Specific type

Selects the type of measurement that you want to define the settings for.

Source

Sets the source of the measurement.

Remote command:

[MEASurement<mg>:SOURce](#) on page 558

Reference levels

Selects the set of reference levels that is used for the measurement (RL1, RL2...), and for the selected source. Each source of the measurement can have its own reference level set.

Only the numbers of defined reference level sets are listed. Define the reference level set before you select it, see [Chapter 9.2.3, "Reference level"](#), on page 199.

Remote command:

[MEASurement<mg>:REFLevel<sc>:REFerence](#) on page 563

Gate

Selects the gate that is used for limiting the measurement range. Define a gate before you select it, see [Chapter 9.2.2, "Gate settings for measurements"](#), on page 197.

Remote command:

[MEASurement<mg>:GATE](#) on page 563

Label

Adds a user-defined label to the measurement.

Envelope

This setting is only available for measurements on envelope waveforms, see [Acquisition mode](#).

- "Both" The upper and the lower envelope are used in measurements. For time measurements, the averages of min and max values are used, that is, the measurement is performed on the average waveform built from the upper and lower envelope.
- "Maximum" Measurements are performed on the upper envelope.
- "Minimum" Measurements are performed on the lower envelope.

Remote command:

[MEASurement<mg>:ENVSelect](#) on page 559

Pulse count

Available, if "Specific type" is set to "Pulse train".

Sets the number N of positive pulses for the "Pulse train" measurement. This measurement measures the duration of N positive pulses from the rising edge of the first pulse to the falling edge of the N-th pulse.

Remote command:

[MEASurement<mg>:AMPTime:PTCount](#) on page 561

Pulse slope

Available, if "Specific type" is set to "Pulse count".

Sets the first slope of the pulses to be counted.

- "Positive" Positive pulses are counted.
- "Negative" Negative pulses are counted.
- "Either" Both positive and negative pulses are counted.

Remote command:

[MEASurement<mg>:AMPTime:PSLope](#) on page 561

Edges slope

Available, if "Specific type" is set to "Edge count" or "Delay to trigger".

Sets the edge direction to be used for delay measurement: positive, negative, or either edge.

Remote command:

[MEASurement<mg>:AMPTime:ESLope](#) on page 560

Setup/Hold time measurement

Setup/Hold measurements analyze the relative timing between two signals: a data signal and the synchronous clock signal. Setup time is the time that the data signal is steady before clock edge - the time between a data transition and the next specified clock edge. Hold time is the time that the data signal is steady after clock edge - the time between a data transition and the previous specified clock edge.

"Setup/Hold time" measures and displays the setup and hold durations. "Setup/Hold ratio" measurements return the ratio of the setup time to the sum of hold and setup time: $T_{Setup} / (T_{Setup} + T_{Hold})$.

The clock edge can be defined, the polarity of the data signal does not matter.

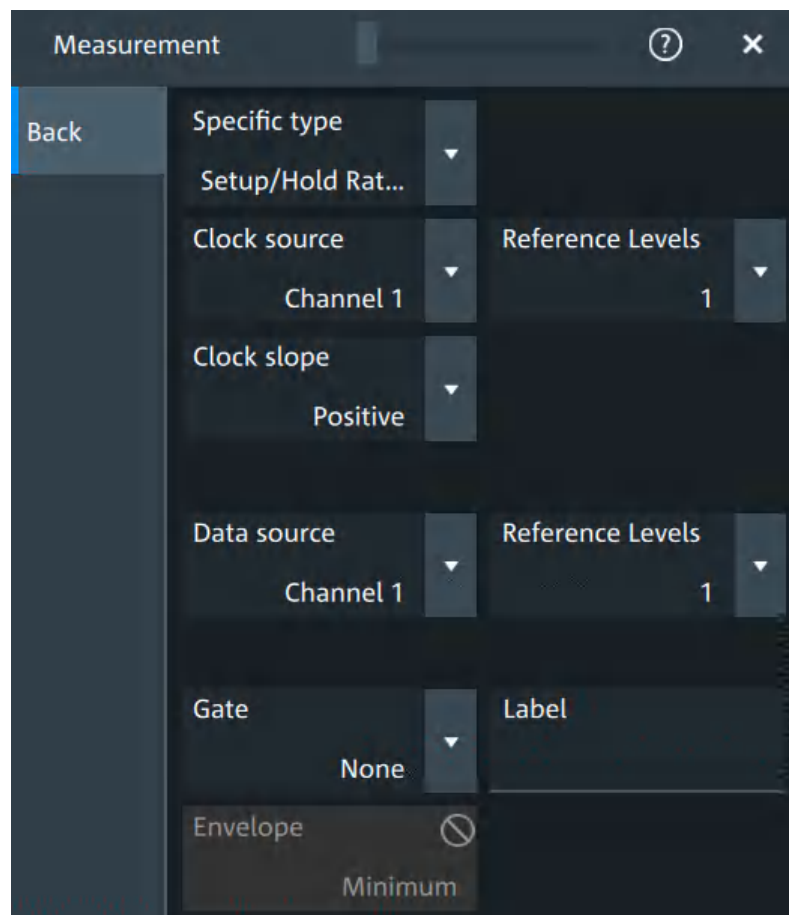
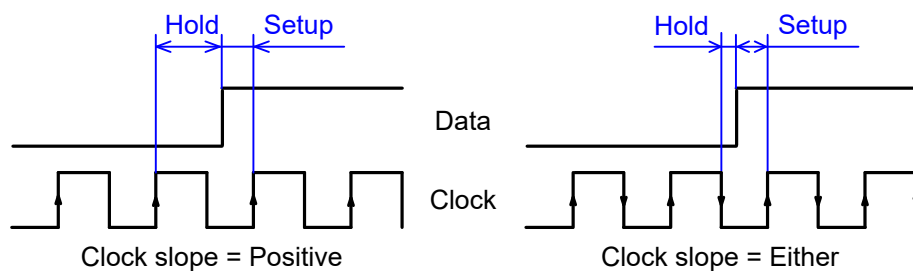

Clock source ← Setup/Hold time measurement

Sets the waveform used as clock in the setup/hold measurement.

Remote command:

[MEASurement<mg>:SSRC](#) on page 559

Clock slope ← Setup/Hold time measurement

Sets the edge of the clock from which the setup and hold times are measured: positive, negative, or either of them. If "Either" is selected, the clock edges next to the data edge are considered regardless of the clock slope.

Remote command:

[MEASurement<mg>:AMPTime:CSLope](#) on page 560

Data source ← Setup/Hold time measurement

Sets the source for the data signal.

Delay measurement

The specific settings for delay measurement allow you to measure the time between any two slopes at any reference level. Therefore, the reference levels and the slopes must be defined for each source individually. The measurement result is negative if the edge of the second source comes before the edge of the first source.

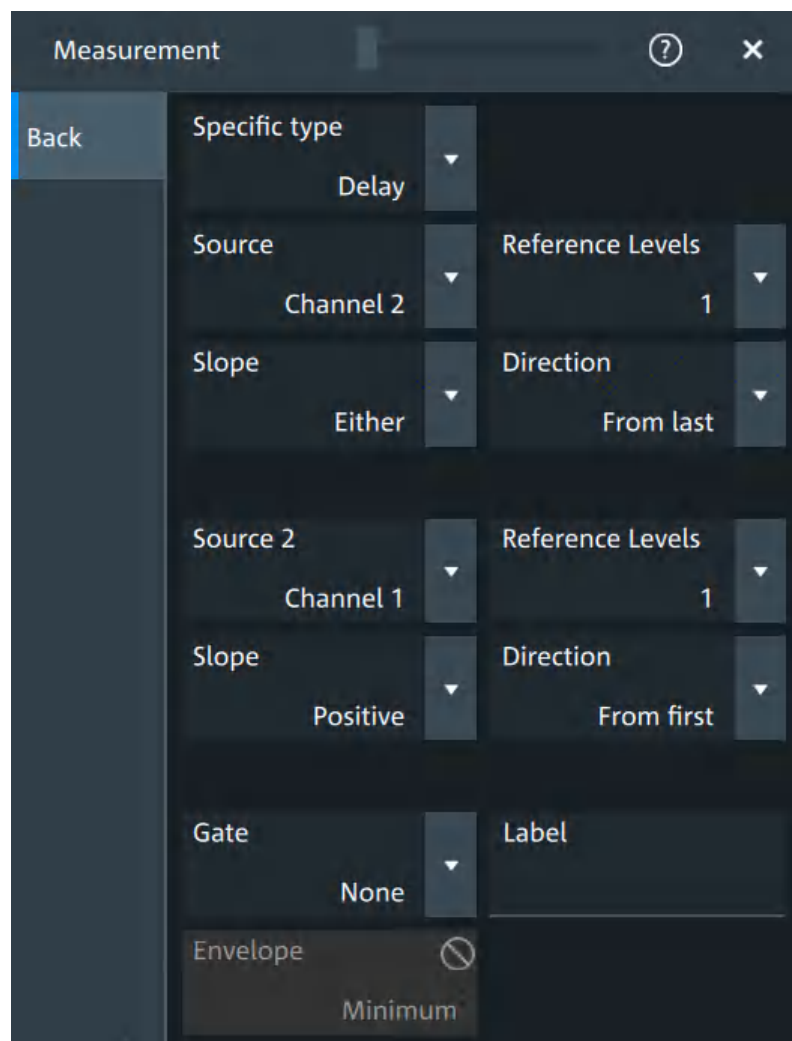

Slope ← Delay measurement

Sets the edge of each source, between which the delay is measured: positive, negative, or either of them.

Remote command:

[MEASurement<mg>:AMPTime:DELAy<n>:SLOPe](#) on page 562

Direction ← Delay measurement

Selects the direction for counting slopes for each source: from the beginning of the waveform, or from the end.

Remote command:

[MEASurement<mg>:AMPTime:DELAy<n>:DIRectiOn](#) on page 561

Delay to trigger measurement settings

Delay to trigger measures the time between the trigger point and the following slope of a waveform. The delay between the trigger and the slope can be high compared to the accuracy of the acquisition, and the trigger point can even be outside of the current acquisition.

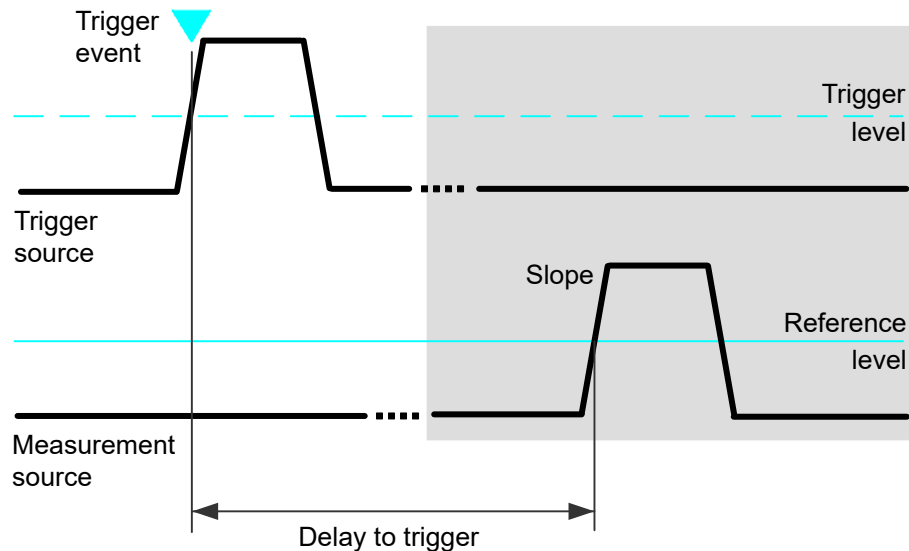

To configure the trigger conditions, use the trigger setup.

"Edges slope" Sets the edge direction to be used for delay measurement: positive, negative, or either edge.

Remote command:

[MEASurement<mg>:AMPTime:DTOTriGger<n>:SLOPe](#) on page 562

9.2.6 Statistics

Access: "Menu" > "Measurement" > "Statistics" tab.

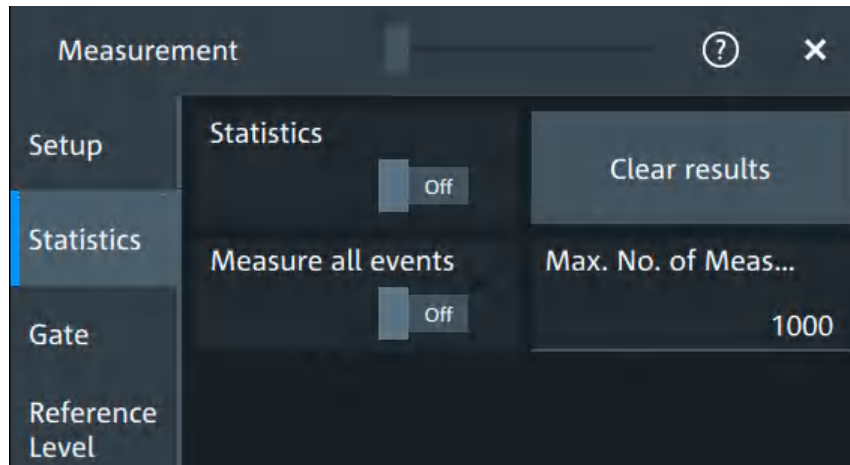

In addition to the current measurement results, you can enable a statistical evaluation. It returns the current, minimum and maximum measurement values, the average and standard deviation, and the number of measured waveforms. The results are shown in a separate tab below the grid. If the cursor measurement is active simultaneously, its results are shown beside the statistics results.

Statistics

Activates or deactivates the statistical evaluation for the measurement.

Remote command:

[MEASurement<mg>:STATistics\[:ENABLE\]](#) on page 567

Clear results

Deletes the statistical results for all measurements, and starts a new statistical evaluation if the acquisition is running.

Remote command:

[MEASurement<mg>:STATistics:ARESet](#) on page 566

Measure all events

Normally, only one measurement is performed for each acquired waveform to get best performance. If "Measure all events" is enabled, more than one result is taken from one acquired waveform and the results are included in evaluation. For example, the rise time is measured on all pulses in the waveform, not only on the first.

The result table shows only the first result of the waveform, the following results are used only for evaluation. The number of considered results can be restricted: see [Max. No. of events](#).

Measuring all events is useful when calculating statistics.

The setting affects all measurements, it is a global setting. However, if a track is enabled for a selected measurement, all results are considered for this measurement, independent from the global setting.

Remote command:

[MEASurement<mg>:MULTiple](#) on page 567

Max. No. of events

Sets the maximum number of measured events per acquisition.

Remote command:

[MEASurement<mg>:MNOMeas](#) on page 567

9.2.7 Track

A track shows the measurement results over time for an acquired waveform. The track is the graphical interpretation of all measurement values of a single acquisition. Furthermore, the track reveals trends of change in the analysis and preserves the timing relationship of the measurement results to the signal.

Tracks can be enabled for each active measurement. Enabling the track also enables "Measure all events" for the selected measurement.

To analyze tracks, you can use cursor measurements, zoom, mathematics and spectrum.

9.2.7.1 Track settings

Access: "Menu" > "Measurement" > "Track" tab.

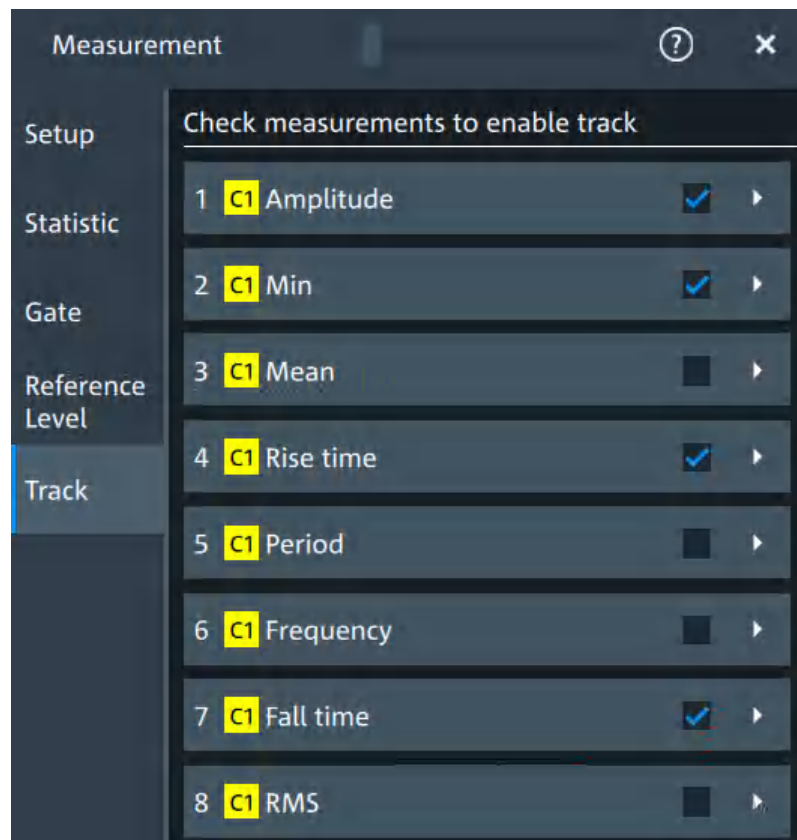

Figure 9-5: Measurement selection for tracks

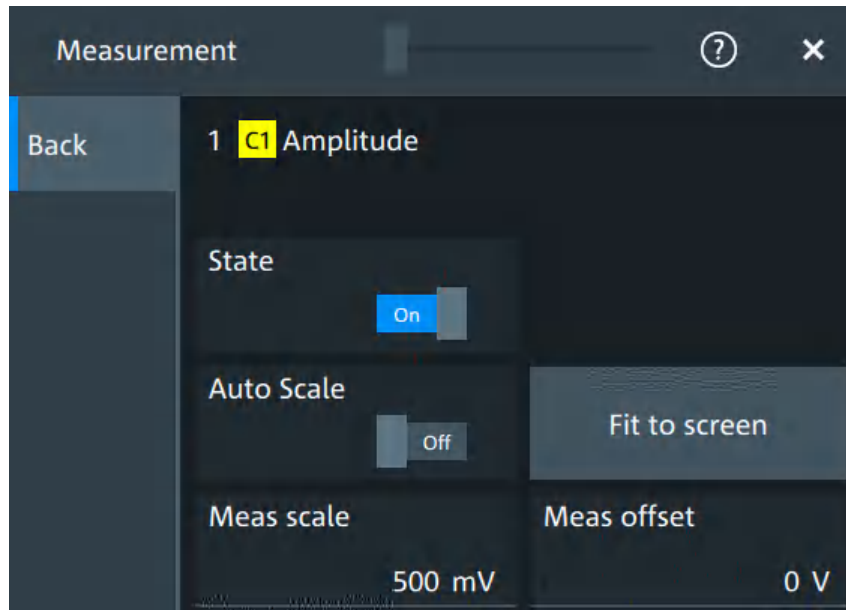

Figure 9-6: Track settings

Check measurements to enable track

The list shows all active measurements. Select the check square of a measurement to enable the track for this measurement. Tap the button to open the track settings.

State

Enables or disables the track for the selected measurement.

Enabling the track also enables "Measure all events" for the selected measurement.

Remote command:

[MEASurement<mg>:TRACk\[:STATe\]](#) on page 575

Auto Scale

Performs an automatic scaling whenever the track does not fit in the diagram during the measurement period.

Remote command:

[MEASurement<mg>:TRACk:CONTiunous](#) on page 575

Fit to screen

Sets the vertical scale and the offset of the track, so that the complete height of the diagram is used.

Remote command:

[MEASurement<mg>:TRACk:AUTO](#) on page 575

Meas scale

Defines the vertical scale of the track diagram. If "Auto Scale" is on, the current scale value is displayed.

You can also select the track waveform and use the vertical [Scale] knob to change the scale.

Remote command:

[MEASurement<mg>:TRACk:SCALe](#) on page 576

Meas offset

Defines the offset of the track waveform. If "Auto Scale" is on, the current offset value is displayed.

You can also select the track waveform and use the vertical [Position] knob to change the offset.

Remote command:

[MEASurement<mg>:TRACk:OFFSet](#) on page 576

9.2.7.2 Examples of track usage

The examples in this section provide ideas on how you can use tracks for waveform analysis.

Tracks with math functions



Figure 9-7: Tracks used in math functions

The example is set up as follows:

- Waveform on channel 1
- 3 measurements on C1: positive duty cycle, period and positive pulse width
- Enable track for each measurement: Track 1 (positive duty cycle), Track 2 (period), Track 3 (positive pulse width)
- Math1 = Trk1 * Trk2
- Math2 = Math1 / 100

Expected values: $\text{Period} * \text{Pos. duty cycle} / 100 = \text{Positive pulse width, i.e. Math2} = \text{Trk3}$

- $\text{Math3} = \text{Math2} - \text{Trk3}$
Expected values = 0

Spectrum on track



Figure 9-8: Track and spectrum on track, C1 is not in diagram

The example is set up as follows:

- Waveform on channel 1
- Period measurement on C1
- Enable track for the period measurement: Track 1
- Spectrum with "Source" = Track 1
- Enable "PeakList" > "Peak on waveform"

Zoom on track

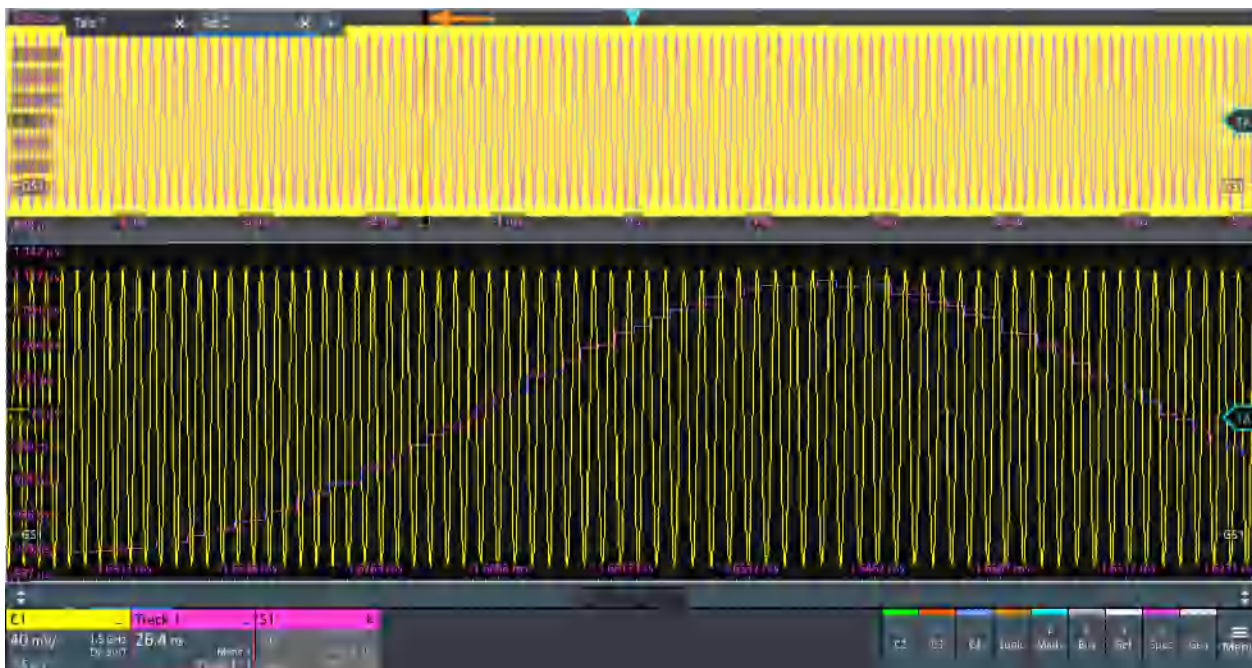

Figure 9-9: Track and C1 in the upper diagram, zoom below

The example is set up as follows:

- Waveform on channel 1
- Period measurement on C1
- Enable track for the period measurement: Track 1
- Drag and drop the track on the channel waveform
- Create zoom

10 Spectrum analysis

The R&S MXO 5 provides an easy way to set up a spectrum analysis. The spectrum settings are independent of the time domain settings but the time and frequency domains are time-correlated.

10.1 Fundamentals of spectrum analysis

During spectrum analysis, a signal in the time domain is converted to a spectrum of frequencies. As a result, either the magnitude or the phase of the determined frequencies can be displayed. Spectrum analysis can be restricted to an extract of the original time base, and the results display can be restricted to a specified frequency range.

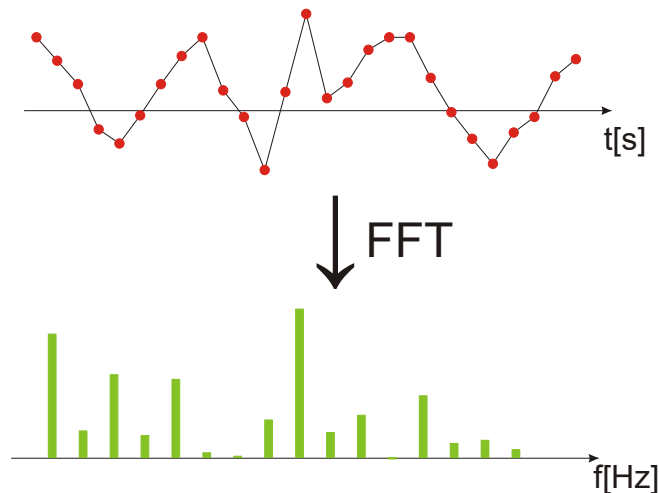

Window functions

Each frame is multiplied with a specific window function after sampling in the time domain. Windowing helps minimize the discontinuities at the end of the measured signal interval and thus reduces the effect of spectral leakage, increasing the frequency resolution.

There are several window functions that can be used in FFT analysis. Each of the window functions has specific characteristics, including some advantages and some trade-offs. Consider these characteristics carefully to find the optimum solution for the measurement task.

For details, see ["Window type"](#) on page 224.

Gating functions

You can restrict the time base of the input signal for which spectrum analysis is to be performed. You can define start and stop times for the time base extract.

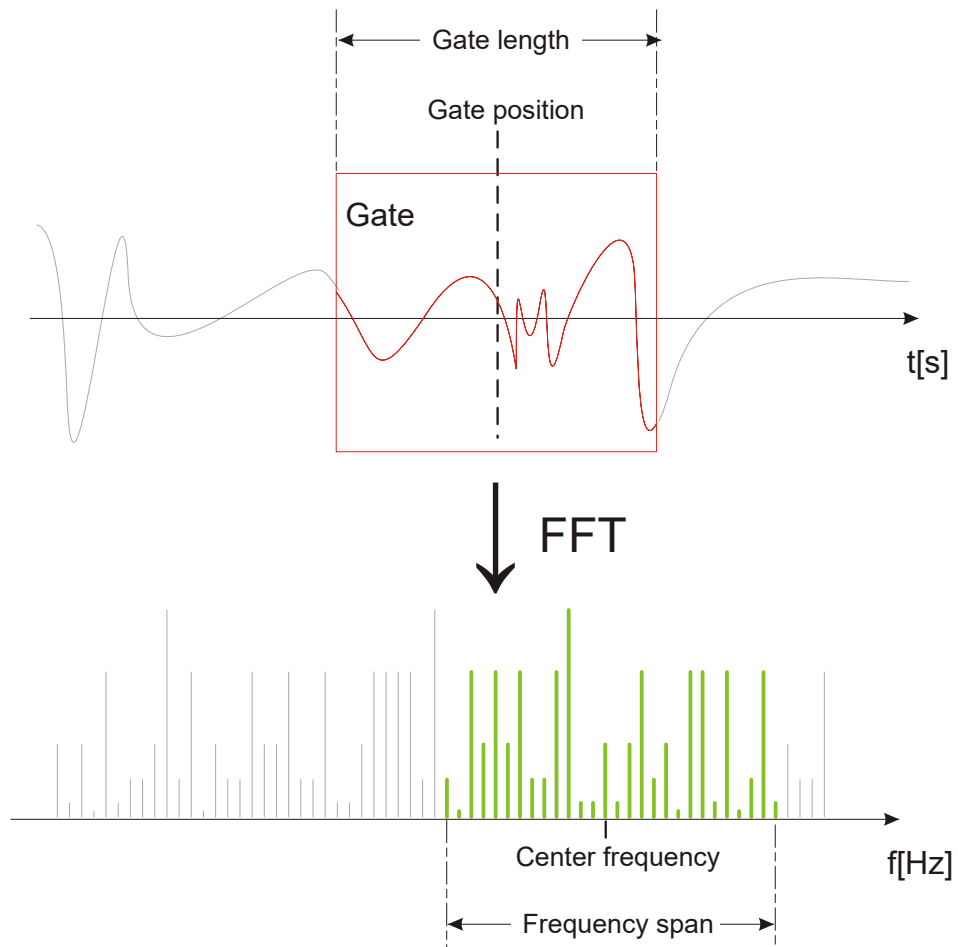

Restricting the result range

You can restrict the results of the spectrum analysis to a specified frequency range. The frequency range can be defined in two ways:

- Define a center frequency and frequency span
- Define start and stop frequencies

Dependencies between spectrum parameters

Spectrum analysis in the R&S MXO 5 is highly configurable. Several parameters, including the resolution bandwidth, frequency span and center frequency, can be defined according to your requirements. Note, however, that several parameters are correlated and not all can be configured independently of the others.

The **resolution bandwidth** defines the minimum frequency separation at which the individual components of a spectrum can be distinguished. Small values result in high precision, as the distance between two distinguishable frequencies is small. Higher values decrease the precision, but increase measurement speed.

The minimum achievable RBW depends on the integration time which is equivalent to the number of samples available for calculation. If a higher spectral resolution is

required, the number of samples must be increased by using a higher sample rate or longer record length. To simplify operation, some parameters are coupled and automatically calculated, such as record length and RBW.

The **frequency span** and **center frequency** define the start and stop frequency of the spectral diagram. By default, a suitable frequency range according to the resolution bandwidth is selected, in respect to performance and precision. Span and RBW settings are coupled, so that the parameters can be adjusted automatically as necessary.

With a **Span/RBW ratio** of 100 and a screen resolution of 1000 pixels, each frequency in the spectrum is displayed by 10 pixels. A span/RBW ratio of 1000 provides the highest resolution. For full flexibility, the span/RBW coupling can also be disabled. Note, however, that a higher span/RBW ratio (i.e. low RBW values and large frequency spans) result in large amounts of data and extend the duration of the calculation.

10.2 Configuring spectrum waveforms

During spectrum analysis, a signal in the time domain is converted to a spectrum of frequencies. A basic spectrum waveform can be displayed quickly. By defining additional parameters, the waveform can be configured in more detail.

To display a basic spectrum waveform

1. Press the [FFT] key.

The "Setup" tab of the "Spectrum" dialog box opens.

2. Set the "Source" to the input signal.
3. Enable "Display".

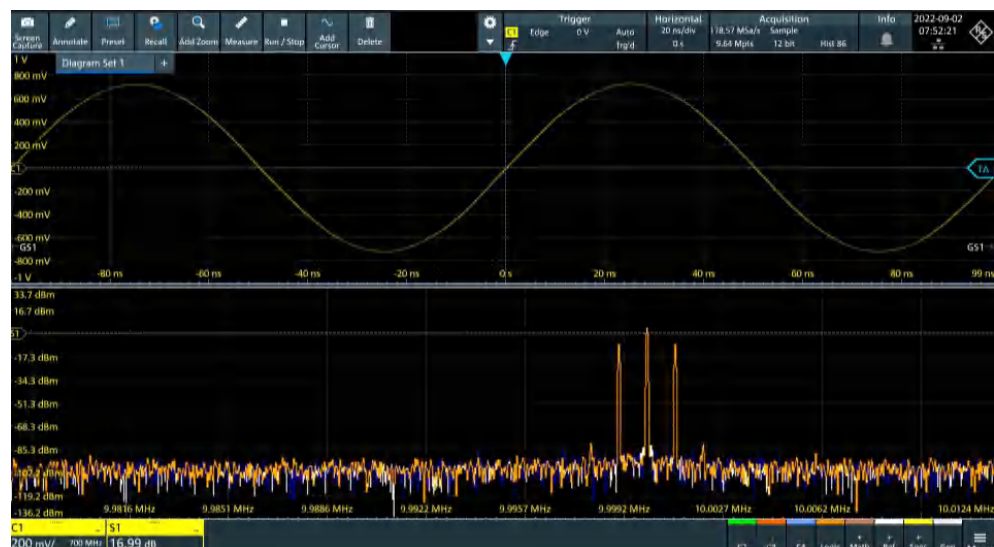

4. If necessary, edit the spectrum waveform parameters as described in the following procedures.

To configure the spectrum

By default, a suitable frequency range for the expected horizontal values according to the resolution bandwidth is selected, in respect to performance and precision. Span and RBW settings are coupled. If a more precise evaluation is required, for example for postprocessing in a different application, disable the coupling and change the frequency ranges and resolution bandwidth values as required.

1. Press [FFT].

The "Spectrum" dialog opens.

2. In the "Setup" tab, specify the frequency range you want to display using one of the following methods:

- Select "CF span". Enter a "Center" and a "Span" that define the spectrum.
- Select "Start Stop". Enter a "Start" and "Stop" frequencies that define the spectrum.
- Tap the "Full span" button to display the complete spectrum resulting from the FFT analysis.

3. Define the resolution bandwidth for the spectrum result.

The resolution bandwidth defines how precise the results are, i.e. how close together the individual frequencies can be. Small values result in high precision, as the distance between two distinguishable frequencies is small. Higher values decrease the precision, but increase performance.

You can define the RBW manually, or couple it to other settings. Do one of the following:

- To couple the RBW to the span, enable "Auto RBW". Define the "Span/RBW" ratio, the smaller the ratio, the higher the RBW becomes to display the same frequency span.
- Disable "Auto RBW". Enter the "RBW" manually.

4. Tap "Advanced".

5. Select the most suitable "Window type" for your source data. Window functions are multiplied with the input values and thus can improve the spectrum display. For details, see "[Window type](#)" on page 224.

To restrict the input values (gating)

You can restrict the time range for which the FFT is calculated, resulting in a restricted spectrum.

1. Open [FFT] > "Gate" tab.
2. Enter the "Start" and the "Stop" times that define the gate area.
3. Set the "Position" and the "Width".

The spectrum waveform displays the spectrum for the specified time span.

10.3 Spectrum setup

Access: "Menu" > "Spectrum" > "Setup" tab.

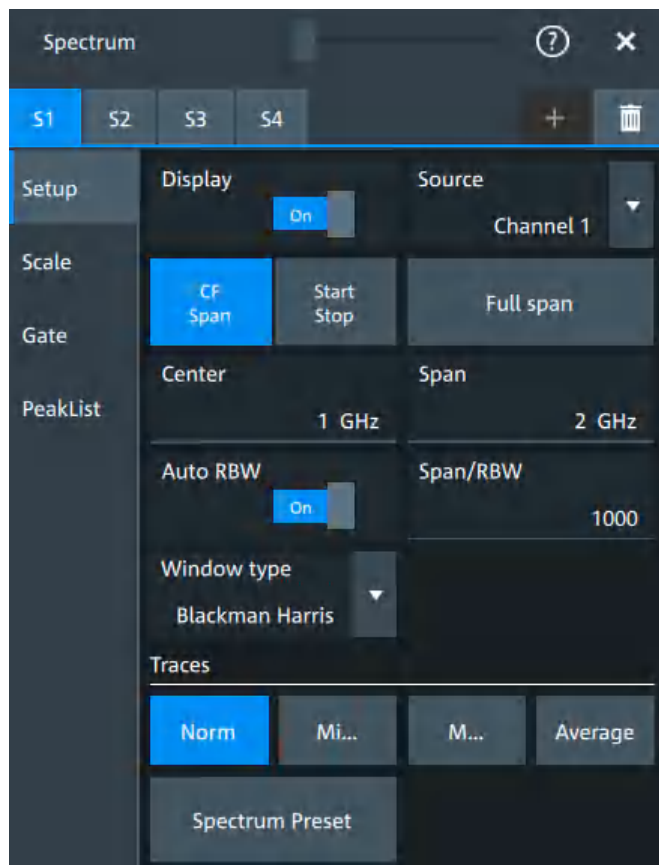

In this tab, you define the settings for the spectrum window. The display can be restricted to the results for a certain time base extract and to a specified frequency range.



The settings in this dialog are greyed out and cannot be changed, if "Coupling" is enabled in the "Scale" tab.

Display

Enables the spectrum.

Remote command:

[CALCulate:SPECTrum<sp>:STATe](#) on page 594

Source

Selects the source for the spectrum.

Remote command:

[CALCulate:SPECTrum<sp>:SOURce](#) on page 593

Full span

Displays the full frequency span.

CF span, Start Stop

Selects if the frequency span is defined through a "Center"/"Span" pair or through the "Start"/"Stop".

Center

Defines the position of the displayed frequency range, which is $(\text{Center} - \text{Span}/2)$ to $(\text{Center} + \text{Span}/2)$. The width of the range is defined using the frequency span setting.

Remote command:

`CALCulate:SPECTrum<sp>:FREQuency:CENTer` on page 590

Span

The span is specified in Hertz and defines the width of the displayed frequency range, which is $(\text{Center} - \text{Span}/2)$ to $(\text{Center} + \text{Span}/2)$. The position of the span is defined using the "Center" setting.

Remote command:

`CALCulate:SPECTrum<sp>:FREQuency:SPAN` on page 590

Start

Defines the start frequency of the displayed frequency span.

Remote command:

`CALCulate:SPECTrum<sp>:FREQuency:STARt` on page 591

Stop

Sets the stop frequency of the displayed frequency span.

Remote command:

`CALCulate:SPECTrum<sp>:FREQuency:STOP` on page 591

Auto RBW

Couples the frequency span to the "RBW" setting.

If span and RBW values are coupled, changing the span also changes the RBW.

Remote command:

`CALCulate:SPECTrum<sp>:FREQuency:BANDwidth[:RESolution]:AUTO`
on page 589

Span/RBW

Defines the coupling ratio for Span/RBW.

This setting is only available if "Auto RBW" is enabled.

Remote command:

`CALCulate:SPECTrum<sp>:FREQuency:BANDwidth[:RESolution]:RATio`
on page 589

RBW

Defines the resolution bandwidth. Note that the resolution bandwidth is correlated with the span, record length and acquisition time. If a constant record length is to be used, the RBW can be adapted if the required number of samples cannot be acquired.

Remote command:

`CALCulate:SPECTrum<sp>:FREQuency:BANDwidth[:RESolution] [:VALue]`
on page 589

Window type

Selects the window type. Windowing helps minimize the discontinuities at the end of the measured signal interval and thus reduces the effect of spectral leakage, increasing the frequency resolution.

Various different window functions are provided in the R&S MXO 5 to suit different input signals. Each of the window functions has specific characteristics, including some advantages and some trade-offs. Consider these characteristics carefully, to find the optimum solution for the measurement task.

Window type	Frequency resolution	Magnitude resolution	Measurement recommendation
Rectangular	Best	Worst	Separation of two tones with almost equal amplitudes and a small frequency distance
Hamming Hann	Good	Poor	Frequency response measurements, sine waves, periodic signals and narrow-band noise
Blackman Harris (default)	Worst	Best	Mainly for signals with single frequencies to detect harmonics Accurate single-tone measurements
Gaussian	Good	Good	Weak signals and short duration
Flattop2	Poor	Best	Accurate single-tone measurements
Kaiser Bessel	Poor	Good	Separation of two tones with differing amplitudes and a small frequency distance

Remote command:

`CALCulate:SPECTrum<sp>:FREQuency:WINDow:TYPE` on page 591

Traces

Spectrum analysis can only be performed on a maximum number of values at once. If more values must be calculated, the input signal is divided into segments, each of which is calculated separately. The segments need not to be disjunct. In this case, the arithmetic mode defines how the final result is calculated from the individual results.

The following methods are available:

- "Norm" The data of only one segment is considered. In effect, no arithmetics are processed.
- "Min hold" Determines the minimum result for each input value from the data of the current acquisition and the acquisitions before.
- "Max hold" Determines the maximum result for each input value from the data of the current acquisition and the acquisitions before.
- "Average" The average is calculated over the number of segments set with "Average count".

Remote command:

`CALCulate:SPECTrum<sp>:WAVEform:AVERAge:ENABle` on page 595

`CALCulate:SPECTrum<sp>:WAVEform:AVERAge:COUNT` on page 595

`CALCulate:SPECTrum<sp>:WAVEform:MAXimum:ENABle` on page 595

`CALCulate:SPECTrum<sp>:WAVEform:MINimum:ENABle` on page 595

`CALCulate:SPECTrum<sp>:WAVEform:NORMal[:ENABle]` on page 596

Spectrum preset

Presets the spectrum measurement.

Remote command:

`CALCulate:SPECTrum<sp>:PRESet` on page 593

10.4 Spectrum scale

Access: "Menu" > "Spectrum" > "Scale".

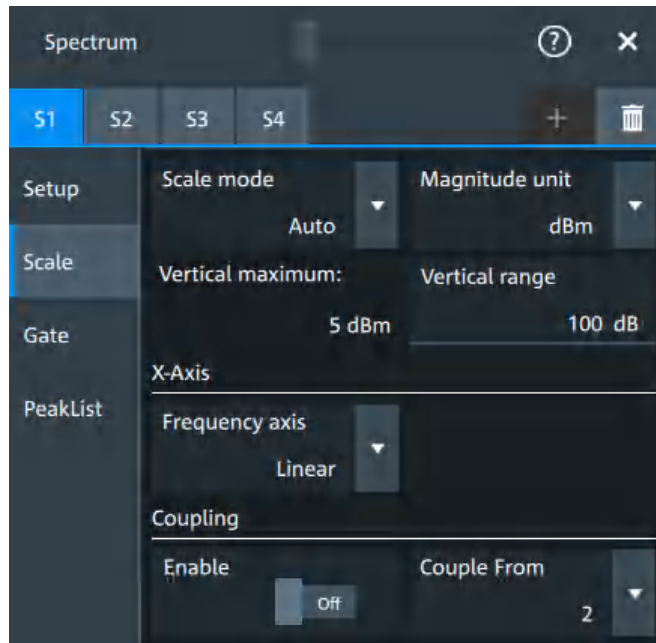

Scale mode

By default, the vertical scale is adapted to the current measurement results automatically to provide an optimal display. However, if necessary, you can define scaling values manually to suit your requirements.

Note: When you change the scaling values manually using the [Scale] rotary knob, the scale mode is set to "Manual" temporarily.

"Manual" Enter the required values for "Vertical maximum" and "Vertical range".

"Auto" "Vertical maximum" is read-only.

Magnitude unit

Sets the unit for the y-axis.

The display values are calculated for the termination impedance that is set in "Vertical" > "Other" tab > "Impedance".

Remote command:

[CALCulate:SPECTrum<sp>:MAGNitude:SCALE](#) on page 593

Vertical maximum

Sets the maximum displayed value on the vertical scale.

Remote command:

[CALCulate:SPECTrum<sp>:MAGNitude:LEVel](#) on page 592

Vertical range

Sets the range of the spectrum values to be displayed.

Remote command:

[CALCulate:SPECTrum<sp>:MAGNitude:RANGe](#) on page 592

Frequency axis

Defines the scaling method for the frequency axis (x-axis) of the spectrogram.

Available are logarithmic and linear scaling.

Remote command:

[CALCulate:SPECTrum<sp>:FREQuency:SCALE](#) on page 590

Coupling

If the coupling is enabled, the settings of the current spectrum are coupled to the spectrum selected with "Couple from".

10.5 Spectrum gate

Access: "Menu" > "Spectrum" > "Scale"

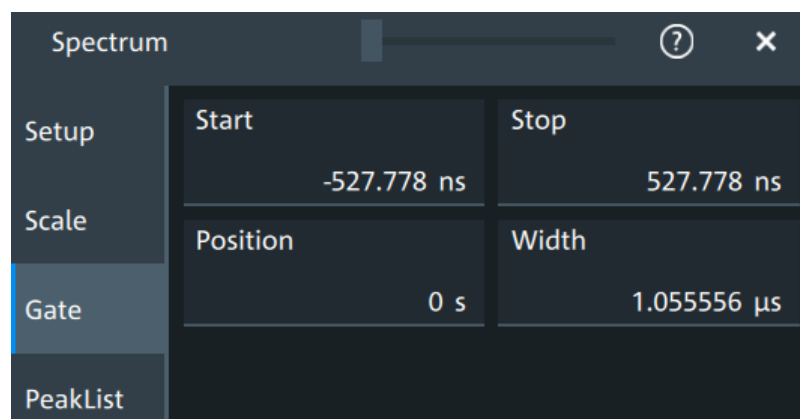

Spectrum gating restricts the spectrum analysis to a user-defined region of the captured time domain signal.

Start

Sets the starting value for the gate.

Remote command:

`CALCulate:SPECTrum<sp>:GATE:START` on page 596

Stop

Sets the end value for the gate.

Remote command:

`CALCulate:SPECTrum<sp>:GATE:STOP` on page 597

Position

Sets the position of the displayed frequency range.

The width of the gate is defined using the "Width" setting.

Remote command:

`CALCulate:SPECTrum<sp>:GATE:POSition` on page 596

Width

Defines the width of the displayed gate.

The position of the span is defined using the "Position" setting.

Remote command:

`CALCulate:SPECTrum<sp>:GATE:WIDTh` on page 597

10.6 Spectrum peak list

A peak list measurement detects all peaks above a user-definable threshold and optionally indicates the peaks in the spectrum diagram.

Access: "Menu" > "Spectrum" > "PeakList".

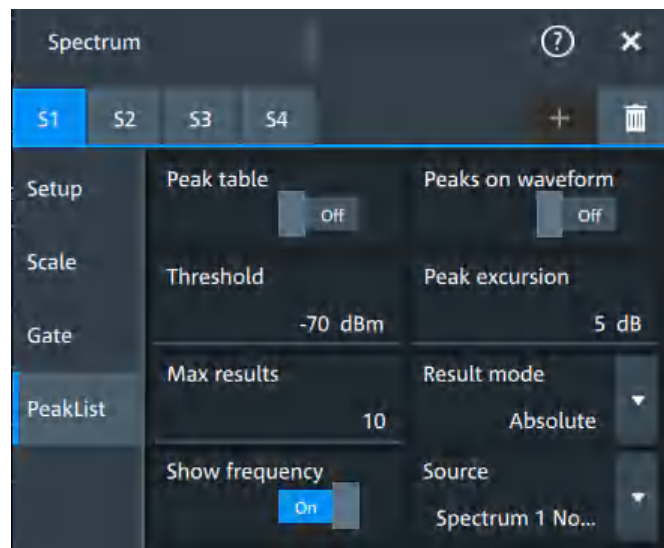

In the peak list dialog, you can define various criteria for a peak search. The peaks can be indicated in the frequency diagram by peak boxes, and the measured peak frequencies and magnitudes are listed in the peak list table.

The number of determined peaks can be defined. You can sort the results by frequency or power value, and the peak labels are adjusted accordingly.



Also, you can adjust some of the display settings, see [Chapter 5.3.4, "Peak list"](#), on page 83.

To analyze the peaks in a spectrum, you can also use cursors on the spectrum waveform and peak search functions. For details, see [Chapter 9.1.3.3, "Peak search tab"](#), on page 191.

Remote commands query peak results and to change the results display:

- `CALCulate:SPECTrum<sp>:PLISt:RESult[:VALue]?` on page 599
- `CALCulate:SPECTrum<sp>:PLISt:SORT:COLumn` on page 599
- `CALCulate:SPECTrum<sp>:PLISt:SORT:ORDer` on page 600
- `CALCulate:SPECTrum<sp>:PLISt:LAbel:INVert` on page 601

Peak table

Enables the display of the peak table.

Remote command:

`CALCulate:SPECTrum<sp>:PLISt[:STATe]` on page 598

Peak on waveform

Displays a box with a description for each detected peak in the spectrum, including the magnitude. If "Show frequency" is enabled, the frequency values are also displayed.

If this option is disabled, the peaks are marked on the diagram only with a point marker.

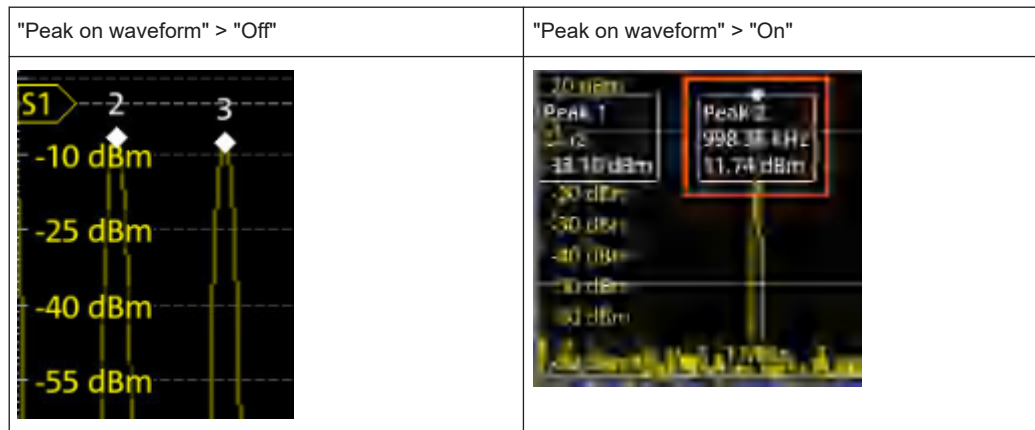

Remote command:

[CALCulate:SPECTrum<sp>:PLIST:SPOW](#) on page 599

Threshold

Sets an absolute threshold as an additional condition for the peak search. Only peaks that exceed the threshold are detected.

This setting is only available for spectrum waveforms. It is valid for cursor measurements, spectrum measurements and peak search.

Remote command:

[CALCulate:SPECTrum<sp>:THReshold](#) on page 594

[CURSor<cu>:THReshold](#) on page 587

Peak excursion

Defines a relative threshold, the minimum level value by which the waveform must rise by to be considered as a peak. For the peak to be considered, the excursion threshold must be met both on the left and the right sides of the peak.

To avoid identifying noise peaks, enter a peak excursion value that is higher than the noise levels.

This setting is only available for spectrum waveforms. It is valid for cursor measurements, spectrum measurements and peak search.

Example:

In the figure below, 2 peaks are shown, that rise above the defined "Threshold". Peak 1 fulfills the defined "Peak excursion" value and is counted as a peak. Peak 2 does not fulfill the defined "Peak excursion" value on the right and is not counted as a peak.

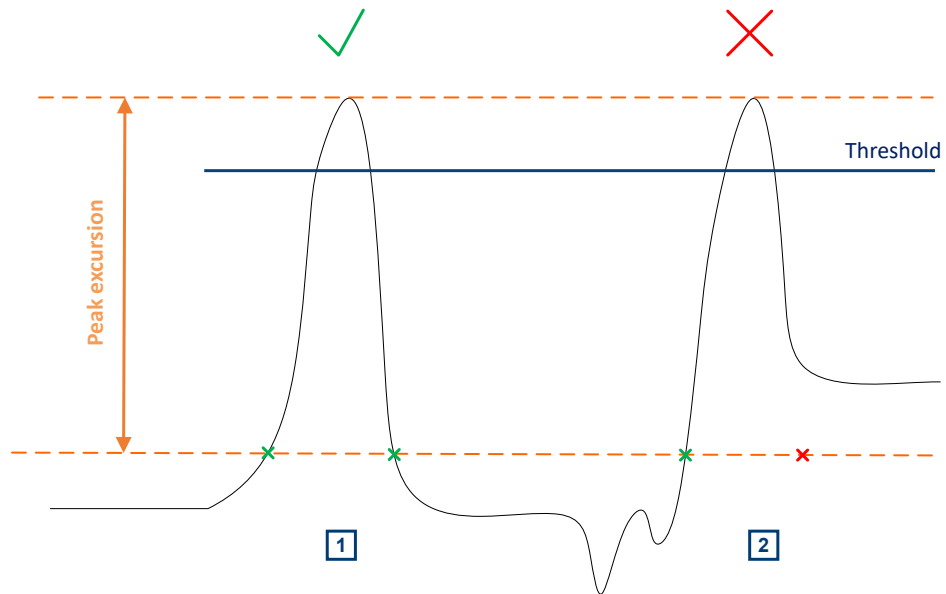

Remote command:

[CALCulate:SPECTrum<sp>:PEXCursion](#) on page 594

[CURSor<cu>:PEXCursion](#) on page 587

Max results

Sets the maximum number of measurement results that are listed in the result table.

Remote command:

[CALCulate:SPECTrum<sp>:PLISt:MAXCount](#) on page 598

Result mode

Selects how the measurement results are displayed.

"Absolute" The peaks are shown in absolute value, dBm.

"Relative" The level of the carrier is shown in absolute value dBm. The values of the peaks are shown relatively to the carrier in dBc.

Remote command:

[CALCulate:SPECTrum<sp>:PLISt:MODE](#) on page 598

Show frequency

Includes the frequency of the detected peak in the diagram labels.

Remote command:

[CALCulate:SPECTrum<sp>:PLISt:LABel:FREQuency\[:STATe\]](#) on page 600

Source

Selects the source of the peak table. You can select one of the traces that is enabled with [Traces](#).

Remote command:

[CALCulate:SPECTrum<sp>:PLISt:SOURce](#) on page 599

11 Applications

All available applications are provided in the "Apps" dialog.

- ▶ To open an application, press the [Apps] key.

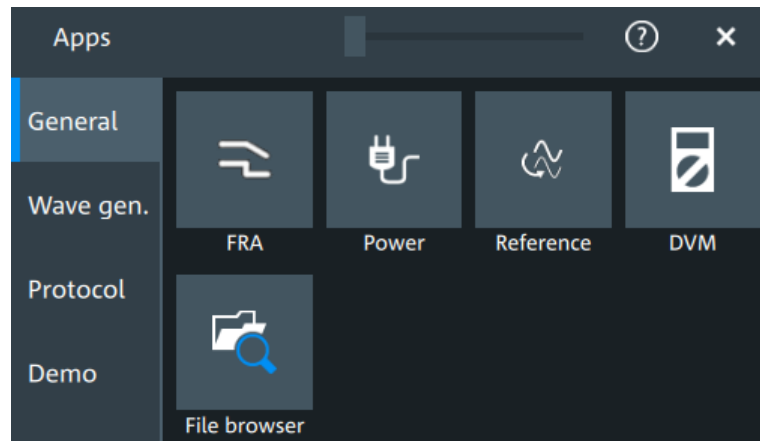

Some applications are described in different chapters. See:

- [Chapter 8.4, "Reference waveforms"](#), on page 176
- [Chapter 15, "Waveform generator \(option R&S MXO5-B6\)"](#), on page 386
- [Chapter 12.5, "File browser dialog"](#), on page 283
- [Chapter 13, "Protocol analysis"](#), on page 285

Also the "Demo" is available in the "Apps" dialog. It is only for demonstration purposes of the functionalities of R&S MXO 5.

11.1 Frequency response analysis (option R&S MXO5-K36)

The frequency response analysis (FRA) option lets you perform low-frequency response analysis on your oscilloscope. It characterizes the frequency response of a variety of electronic devices, including passive filters and amplifier circuits. For switched-mode power supplies, it measures the control loop response (CLR) and power supply rejection ratio (PSRR).

The FRA option uses the oscilloscope's built-in waveform generator to create stimulus signals ranging from 10 Hz to 100 MHz. Measuring the ratio of the stimulus signal and the output signal of the DUT at each test frequency, the oscilloscope plots gain and phase logarithmically.

Having both time and frequency domain views allows you to monitor if the injected signal causes distortion that leads to errors in the measurement.

11.1.1 About the frequency response analysis plot

FRA plot display

The FRA plot display is divided into several sections.

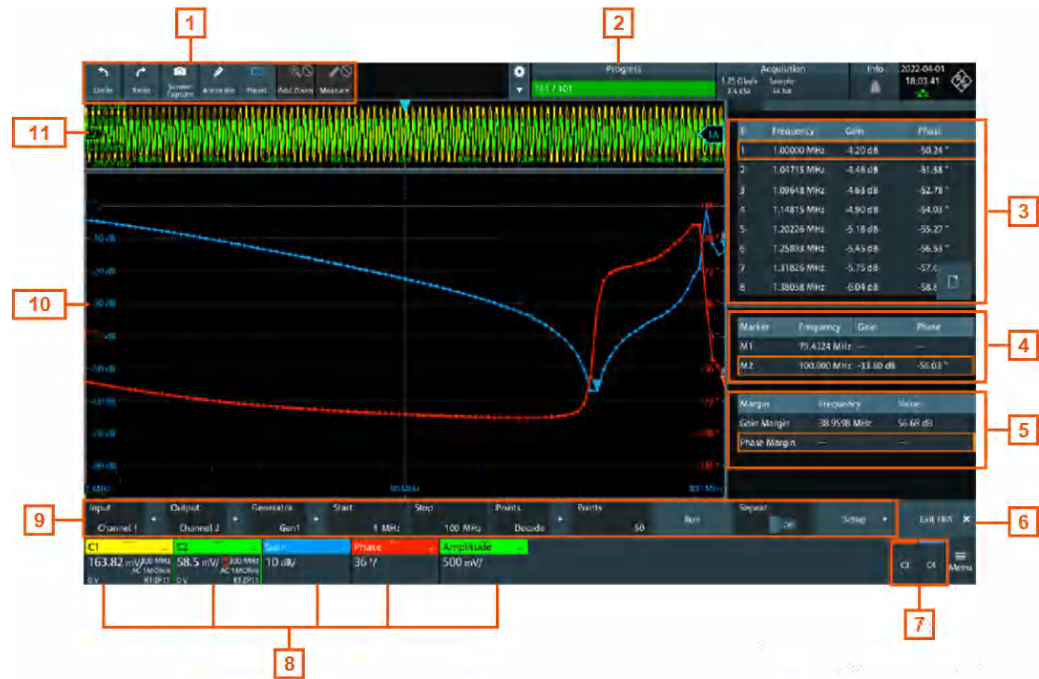

Figure 11-1: FRA plot display

- 1 = Toolbar
- 2 = Progress bar
- 3 = FRA result table
- 4 = Marker value table
- 5 = Margin value table
- 6 = Exit app button
- 7 = Inactive channels
- 8 = Active channels and plots
- 9 = FRA plot controls
- 10 = FRA plot diagram, gain: blue color; phase: red color; amplitude: green color
- 11 = Channel diagram

Progress bar

Displays the current status of the measurement: how many points have already been displayed and the total set number of points.

FRA plot diagram

The FRA plot diagram has the frequency presented on the x-axis. The gain (blue color waveform) and phase (red color waveform) scales are on the y-axis. The gain plot represents the ratio between input and output. The phase plot shows the phase shift between input and output.

FRA plot result table

In the FRA plot result table, all sample points are displayed with the respective value for the frequency, gain, phase and amplitude.

Marker value table

There are two markers available for the FRA plot. They are highlighted on the FRA plot diagram by a white line and the respective marker number 1 or 2. You can move the markers as needed.

In the marker table you can see the frequency, phase and gain values for both of them.

Remote commands:

- [FRANalysis:MARKer<m>:FREQuency](#) on page 617
- [FRANalysis:MARKer<m>:GAIN?](#) on page 617
- [FRANalysis:MARKer<m>:PHASe?](#) on page 617

Margin value table

The margin value displays the gain and the phase margin frequency and value of the system. Higher margin values are an indicator for higher stability of the system.

Remote commands:

- [FRANalysis:MARGin:STATe](#) on page 615
- [FRANalysis:MARGin:GAIN:FREQuency?](#) on page 616
- [FRANalysis:MARGin:GAIN:VALue?](#) on page 616
- [FRANalysis:MARGin:PHASe:FREQuency?](#) on page 616
- [FRANalysis:MARGin:PHASe:VALue?](#) on page 616

Vertical position and size of the waveforms

To set the position and the vertical scaling of the gain, phase or amplitude waveforms, select the waveform and use the vertical [Scale] and [Position] (upper knob) knobs.

The remote commands for setting the position and scales of the are described in [Chapter 17.15.1.4, "Frequency response analysis diagram settings"](#), on page 611.

11.1.2 Using a frequency response analysis

Connecting the test setup



To avoid measurement uncertainties, make sure that the cables connecting the input and the output of your DUT to the oscilloscope are of similar length.

Starting the FRA

1. Press the  [Apps] key.

2. In the "General" tab, tap "FRA".

The FRA window opens. Only the settings relevant for the FRA setup are visible in the "Menu".

Closing the FRA

- ▶ Tap the "Exit FRA" key at the bottom-right corner of the display.

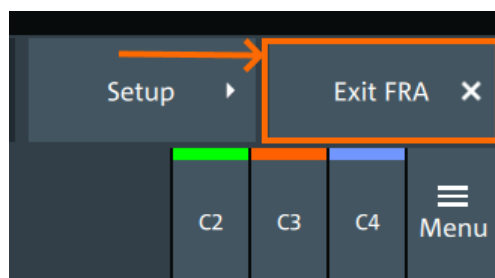

11.1.3 Settings for frequency response analysis

The following chapters, describes the settings that you can define for the frequency response analysis.

11.1.3.1 Setup

Access: [Apps] > "General" > "FRA" > "Setup".

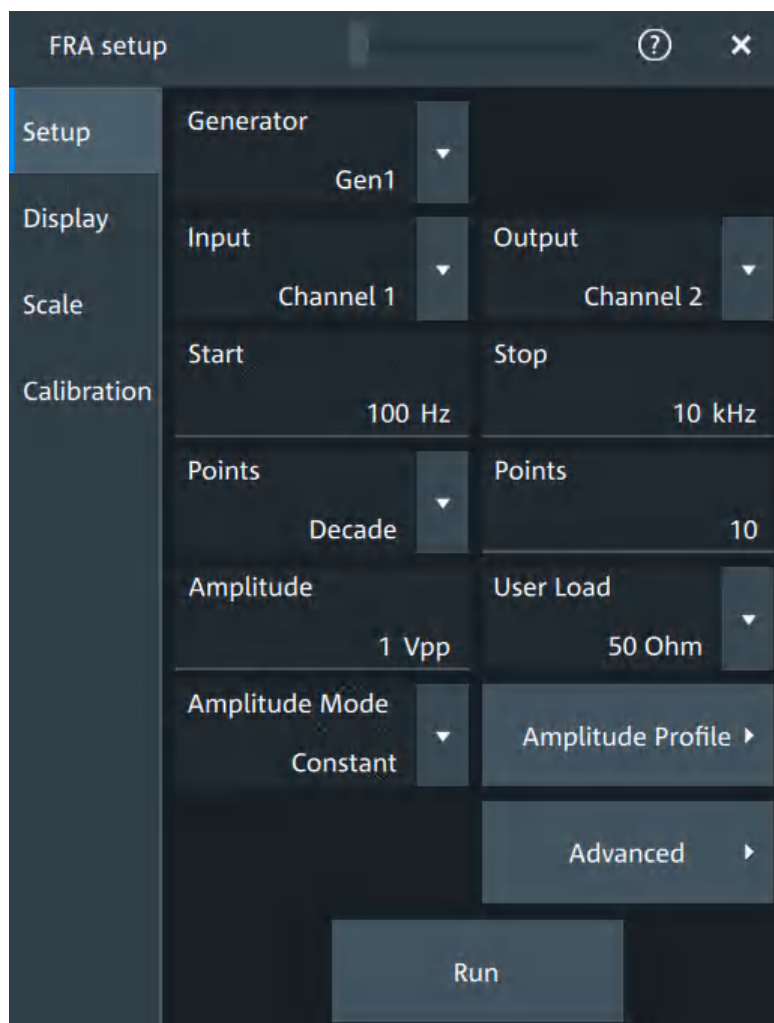
**Input**

Sets the channel for the input signal of the DUT.

Remote command:

[FRANalysis:INPut\[:SOURce\]](#) on page 606

Output

Sets the channel for the output signal of the DUT.

Remote command:

[FRANalysis:OUTPut\[:SOURce\]](#) on page 607

Generator

Selects the built-in generator to start a frequency sweep for a defined frequency range.

Remote command:

[FRANalysis:GENerator\[:CHANnel\]](#) on page 605

Start, Stop

Set the start and stop frequency of the sweep.

Remote command:

`FRANalysis:FREQuency:START` on page 604

`FRANalysis:FREQuency:STOP` on page 605

Points

Selects, if the number of points are measured as total or per decade and sets the number of points.

Remote command:

`FRANalysis:POINTs:TOTal` on page 608

`FRANalysis:POINTs:MODE` on page 607

`FRANalysis:POINTs:LOGarithmic` on page 607

Amplitude

Sets a fixed amplitude for the frequency response analysis.

Remote command:

`FRANalysis:GENerator:AMPLitude` on page 605

User load

Selects the generator voltage display for 50Ω or high impedance load.

Remote command:

`FRANalysis:GENerator:LOAD` on page 605

Amplitude mode

Selects, if the amplitude is a constant value ("Amplitude") or is defined as an amplitude profile.

Remote command:

`FRANalysis:POINTs:MODE` on page 607

Amplitude profile

Opens a dialog to set the amplitude profile. See [Chapter 11.1.3.2, "Amplitude profile"](#), on page 237.

You can then define different amplitudes for different frequencies. The amplitude profile is useful when testing sensitive circuits, where the amplitude gets too high. In this case distortion might occur.

If this function is enabled, a green colored diagram of the amplitudes for the different frequencies can be displayed on the screen.

Remote command:

`FRANalysis:AMPLitude:MODE` on page 604

`FRANalysis:AMPLitude:ENABLE` on page 613

Run

Starts the frequency response analysis.

Remote command:

`FRANalysis:STATe` on page 603

Repeat

Repeats the measurement, using the same parameters.

Remote command:

[FRANalysis:REPeat](#) on page 608

11.1.3.2 Amplitude profile

Access: [Apps] > "General" > "FRA" > "Setup" > "Amplitude profile".

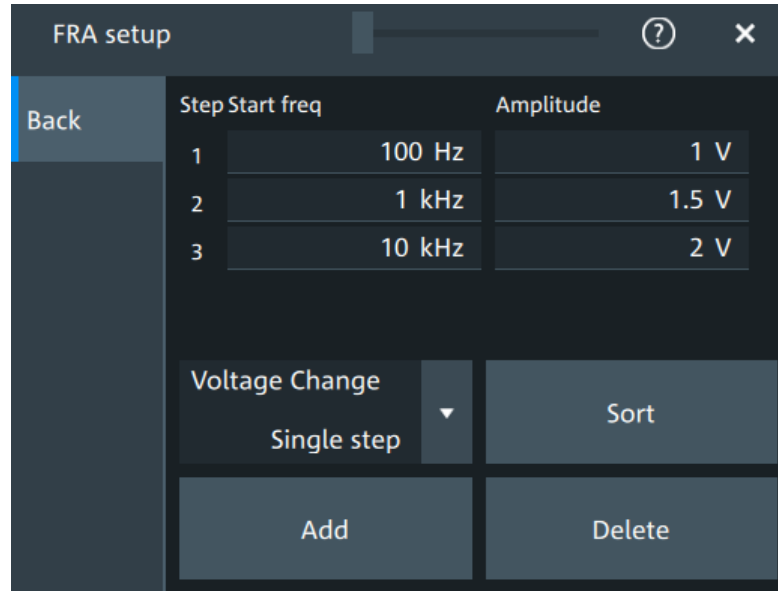

Opens a dialog to set the amplitude profile. You can then define different amplitudes for different frequency. The amplitude profile is useful when testing sensitive circuits, where the amplitude gets too high. In this case distortion can occur.



Step start freq, Amplitude

Set the frequency and amplitude values for the selected point.

Remote command:

[FRANalysis:AMPLitude:PROFile:POINT<m>:AMPLitude](#) on page 610

[FRANalysis:AMPLitude:PROFile:POINT<m>:FREQuency](#) on page 610

[FRANalysis:AMPLitude:PROFile:COUNT](#) on page 609

Voltage change

Selects if the voltage change is done as a single step or as a ramp.

Remote command:

[FRANalysis:AMPLitude:PROFile:MODE](#) on page 610

Add

Adds a new point to the amplitude profile.

Remote command:

[FRANalysis:AMPLitude:PROFile:APOint](#) on page 609

Sort

Sorts the points in the amplitude table by frequency, starting with the lowest frequency.

Remote command:

[FRANalysis:AMPLitude:PROFile:SORT](#) on page 609

Delete

If enabled a delete icon appears next to each point in the amplitude profile table. You can tap on it to delete the amplitude point.

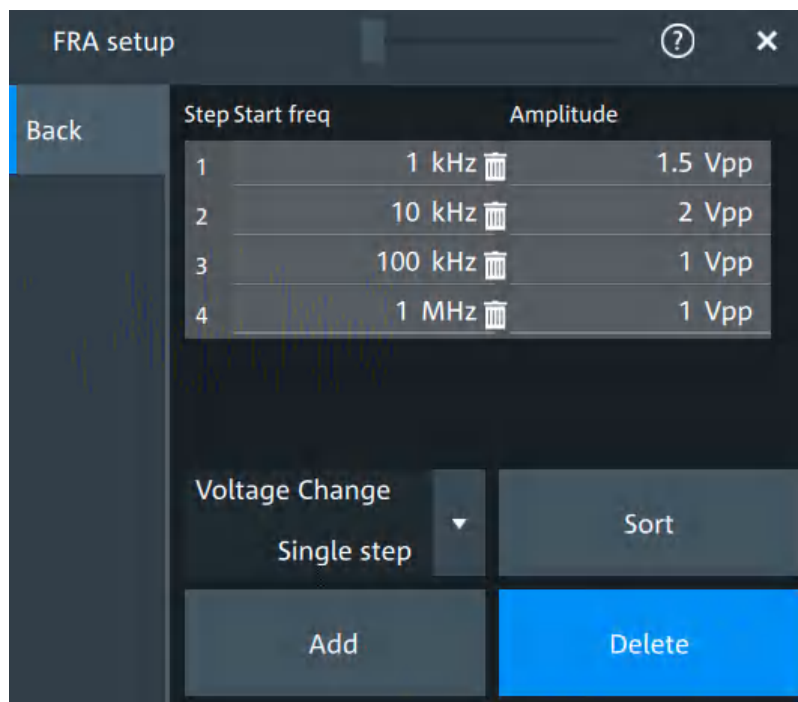

Remote command:

[FRANalysis:AMPLitude:PROFile:POINT<m>:REMOve](#) on page 609

11.1.3.3 Advanced

Access: [Apps] > "General" > "FRA" > "Setup" > "Advanced".

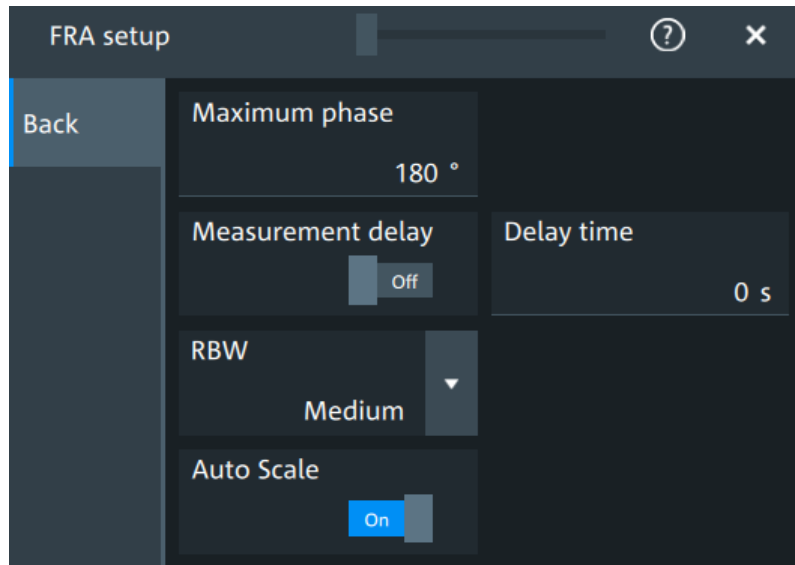

Maximum phase

Sets the upper boundary of the vertical phase window.

The lower boundary is given by "Maximum phase" - 360°.

By default, the "Maximum phase" is set to 180° for a phase window ranging from -180° to 180° accordingly.

Remote command:

[FRANalysis:PHASe:MAXimum](#) on page 608

Measurement delay, Delay time

Sets a time delay, that the system waits before measuring the next point of the plot.

Time delay is helpful in systems that need more time to adapt to the new frequency, for example if filters with significant time group delays are present.

Remote command:

[FRANalysis:MEASurement:DELay:STATE](#) on page 606

[FRANalysis:MEASurement:DELay\[:TIME\]](#) on page 606

RBW

Sets the resolution bandwidth, which determines the number of measurements that are used for creating the plot.

"High (fast)" A high RBW value is useful for obtaining a general understanding of a system's behavior over a wide frequency range. The accuracy of the measurement is not as good, but the measurement is completed fast.

"Medium" A medium RBW value is a compromise between the measurement time and measurement accuracy.

"Low (slow)" A low RBW value allows for a more detailed analysis of the system. Since more data needs to be collected, the measurement time would increase significantly.

Remote command:

[FRANalysis:MEASurement:RBW](#) on page 607

Auto scale

If enabled, the vertical scaling of input and output channel is done automatically for every new measurement frequency point.

That guarantees a non-disturbed signal and a maximum of measurement resolution.

For **Coupling** = "DC", the channel offset is also changed to compensate the signal offset.

Remote command:

[FRANalysis:AUToscale](#) on page 604

11.1.3.4 Display

Access: [Apps] > "General" > "FRA" > "Display".

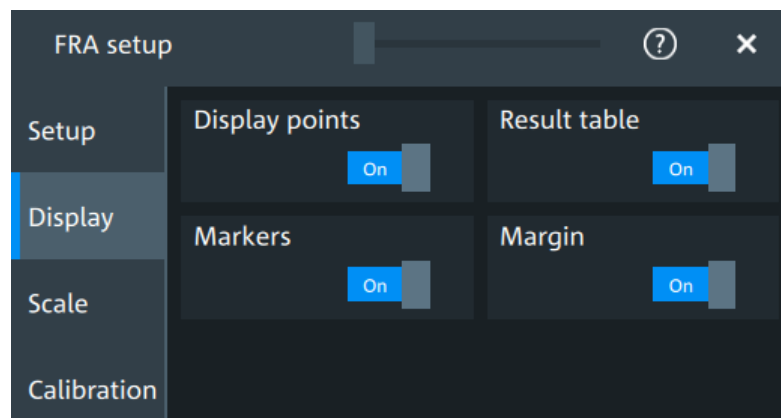

In this dialog, you can select which elements are displayed in the FRA diagram.

Display points

Enables the display of the measurement points for the frequency response analysis.

Remote command:

[FRANalysis:MEASurement:POINT\[:DISPlay\]](#) on page 606

Result table

Enables the display of the result table for the FRA.

Remote command:

[FRANalysis:RESult:STATe](#) on page 615

Markers

Enables the display of the marker table for the FRA.

Remote command:

[FRANalysis:MARKer<m>:STATe](#) on page 616

Margin

Enables the display of the margin table for the FRA.

Remote command:

[FRANalysis:MARGIN:STATe](#) on page 615

11.1.3.5 Scale

Access: [Apps] > "General" > "FRA" > "Scale".

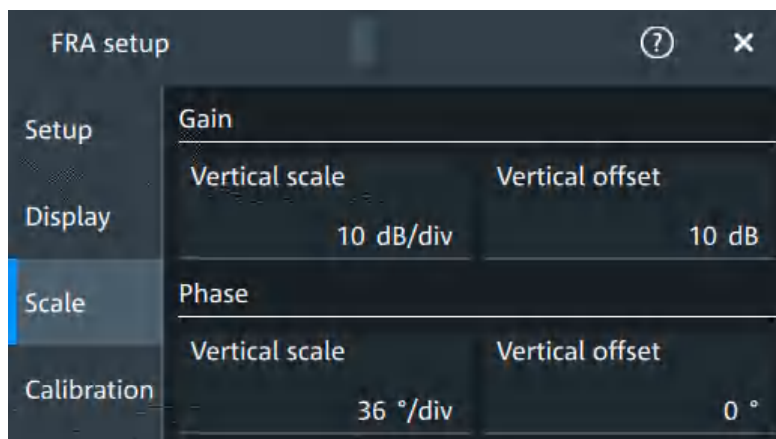

Figure 11-2: Scale dialog for Mode = Gain/Phase

Vertical scale

Sets the scale of the y-axis in the function diagram.

Vertical offset

Sets a voltage offset to adjust the vertical position on the screen.

11.1.3.6 Calibration

Calibration can be used to compensate the electrical parameter of probes, cables, connector or fixtures.

Access: [Apps] > "General" > "FRA" > "Calibration".

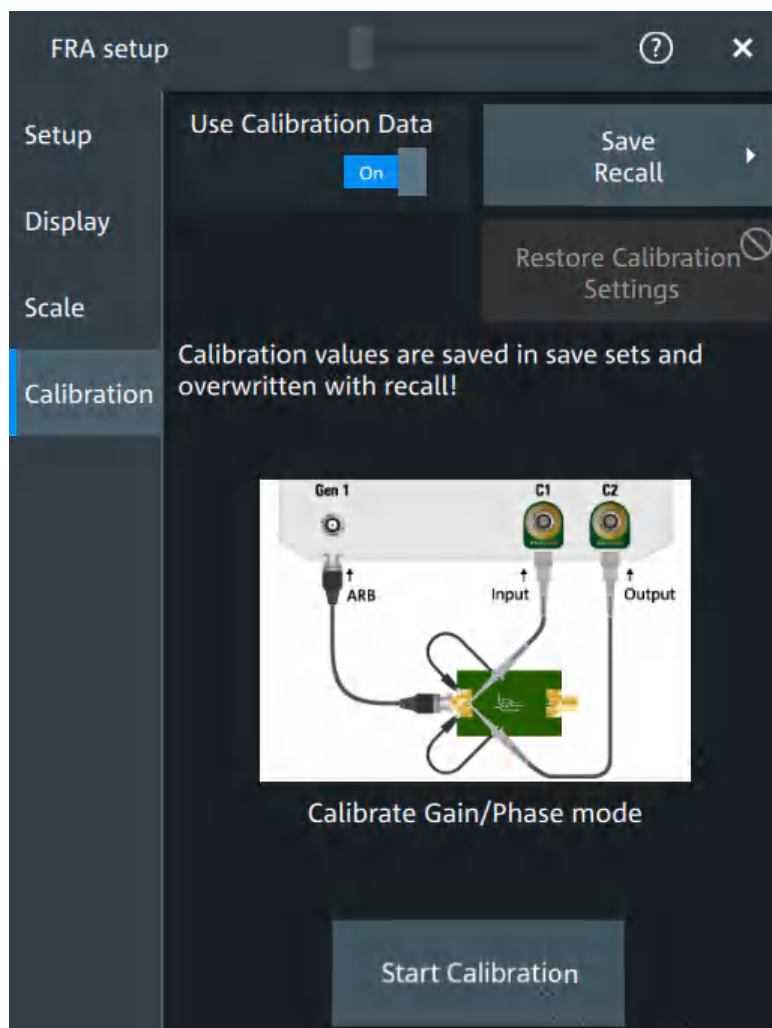

Test setup considerations

[Example of a calibration test setup](#) shows an example of a test setup, where the input probe is connected to [C1] and the output probe is connected to [C2]. The input is also connected to the ARB generator.

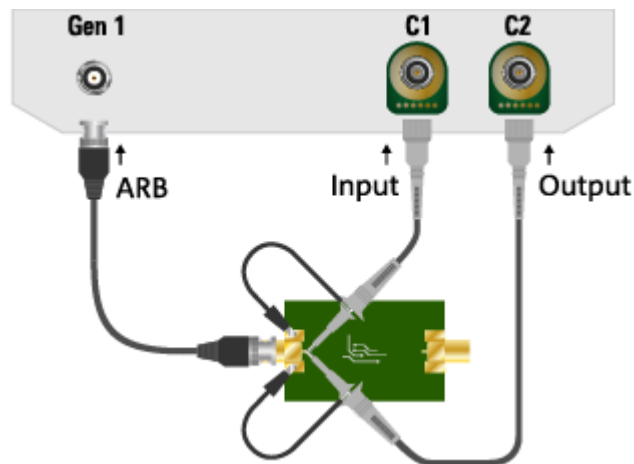

Figure 11-3: Example of a calibration test setup

Input = [C1], [Gen1]
Output = [C2]

Consider also the following:

- Calibration for FRA is only possible with probes connected to the input and output channels.
- For best FRA calibration results, shorten the DUT and place the probe tips as near as possible to each other.
- If there is a fixture for the DUT it should be part of the calibration setup.
- If the DUT needs a termination, it is to be conducted with an external termination direct on DUT output / input.

Calibration state

Once the calibration is started, a label is shown in the toolbar.



The calibration label displays the status of the calibration. The following states are available:

- "Valid": calibration values are used
- "Invalid": device settings changed
- "Running": a calibration cycle is running
- "None": not performed or no data

Settings influencing calibration

Calibration is only valid for the settings that are active during its execution. If one of the following settings is changed, the calibration becomes "Invalid":

- "Input" and "Output" channel
- "Channel coupling" and "Bandwidth"
- "Channel scaling"

- "Generator"
- "User load"
- "Amplitude mode"
- "Amplitude profile"
- "Amplitude profile" > "Voltage change"
- "Start" frequency
- "Stop" frequency
- "Points" mode and total points
- "Measurement delay"
- "Delay time"
- "RBW"

The following settings are available for the calibration:

Use calibration data

If enabled, the user calibration data is used for the frequency response analysis.

Remote command:

[FRANalysis:CALibration:STATe](#) on page 611

Restore calibration settings

Restores the FRA settings, to the values that were selected during the calibration process. This allows you to further perform measurements with a valid calibration state.

See also "[Settings influencing calibration](#)" on page 243.

Save/Recall

Opens the "Save/Recall" dialog. You can recall a saved saveset.

Start calibration

Starts the calibration. The button is only enabled, if there is a valid test setup.

The state of the calibration process is displayed in the calibration label in the toolbar.

After a calibration is performed successfully, the calibration values are saved automatically.

Remote command:

[FRANalysis:CALibration:CALibration](#) on page 611

[FRANalysis:CALibration:RESult?](#) on page 611

11.1.4 FRA saving results

Access: [Apps] > "General" > "FRA" > "Setup" > "Save/Recall" > "Results".

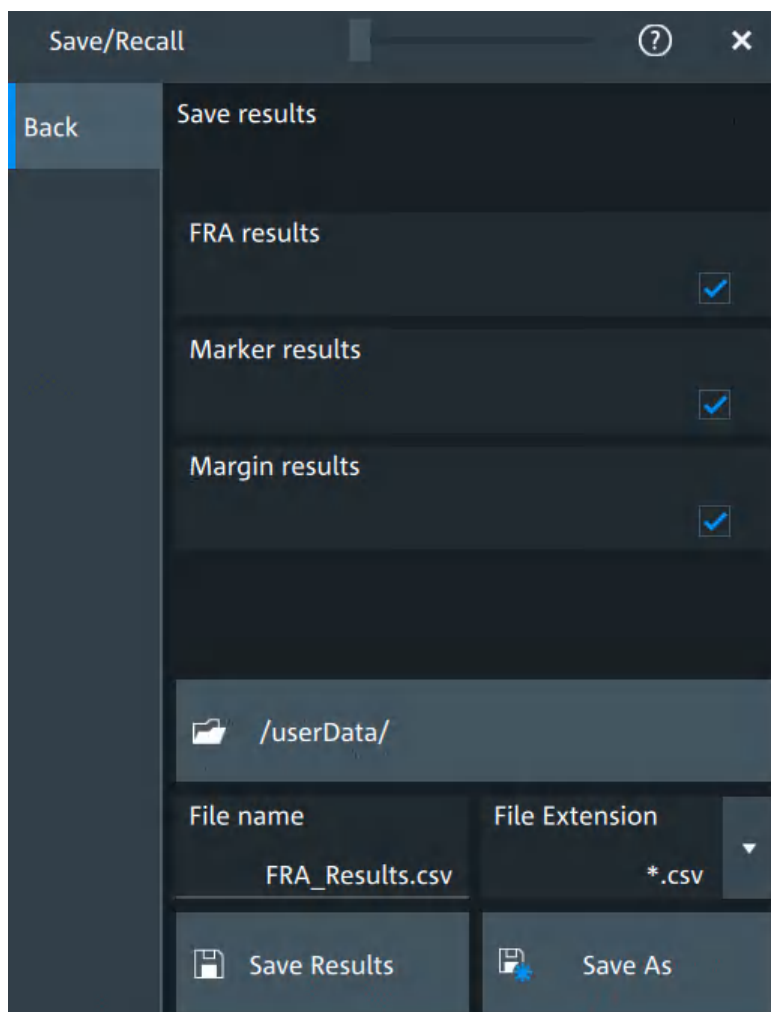

FRA results

In this dialog you can select which result values you want to include in your FRA export results file.

The following options are available:

- "FRA results": includes the frequency, gain, phase and amplitude
- "Marker results": includes the marker frequency and gain
- "Margin results": includes the margin gain and phase

Remote command:

[EXPort:RESult:SElect:FRA:MARGin](#) on page 618

[EXPort:RESult:SElect:FRA:MARKer](#) on page 618

[EXPort:RESult:SElect:FRA:RESult](#) on page 618

11.1.5 Dependencies of the measurement setup

When performing the FRA measurement consider the following dependencies on parameters from the "Vertical" menu.

- [Coupling](#):

- For frequencies smaller than 10 Hz, the "Coupling" on page 116 is set to DC.
- For frequencies higher than 10Hz, you can select a Coupling manually. The default set value is AC.
- The bandwidth value is changed to a higher value, if the selected bandwidth is smaller than double the stop frequency.
- If the bandwidth of the connected probe is lower than the "Stop" frequency, a warning is shown.

11.2 Power analysis (option R&S MXO5-K31)

With the R&S MXO 5 and option R&S MXO5-K31, you can perform power analysis measurements.



For best measurement results, it is recommended to set Bandwidth = 20 MHz. If using the HD mode, it is recommended to set Bandwidth = 100 MHz.

11.2.1 Power measurement selection

To add a new power measurement

1. Tap the "Menu" > "Apps" > "General" tab > "Power", to open the power measurement dialog.
2. In the "Analysis" tab, tap "Add".

A dialog opens to select the power measurements.

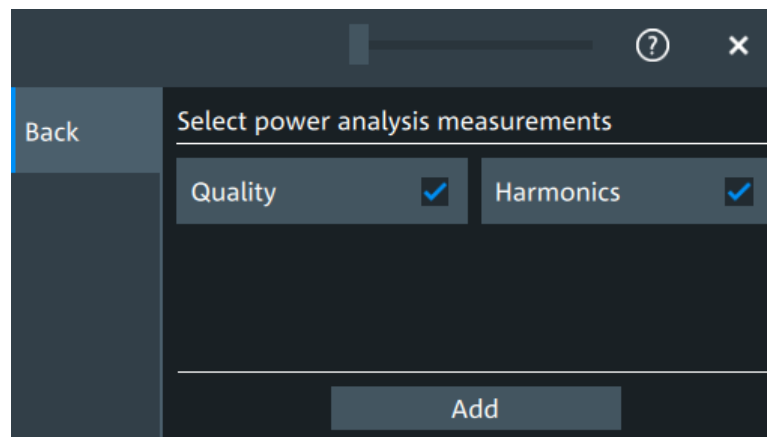

3. Tap on a power measurement from the list to enable it. Selected measurements are marked with a blue check mark in their checkbox.
4. Tap "Add" to add the selected measurements. All selected measurements are enabled.

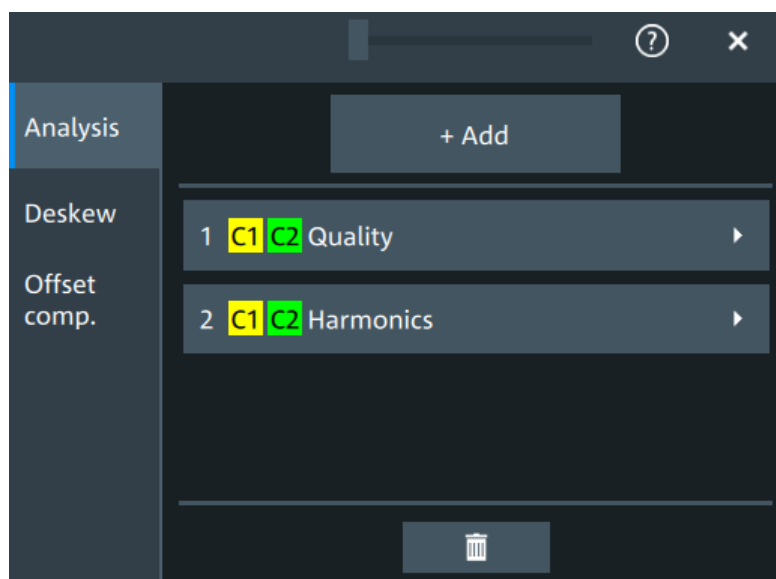

To delete a measurement

1. Tap the "Menu" > "Apps" > "General" tab > "Power", to open the power measurement dialog.
2. In the "Analysis" tab, tap .

A delete icon appears in the selection button of each measurement.

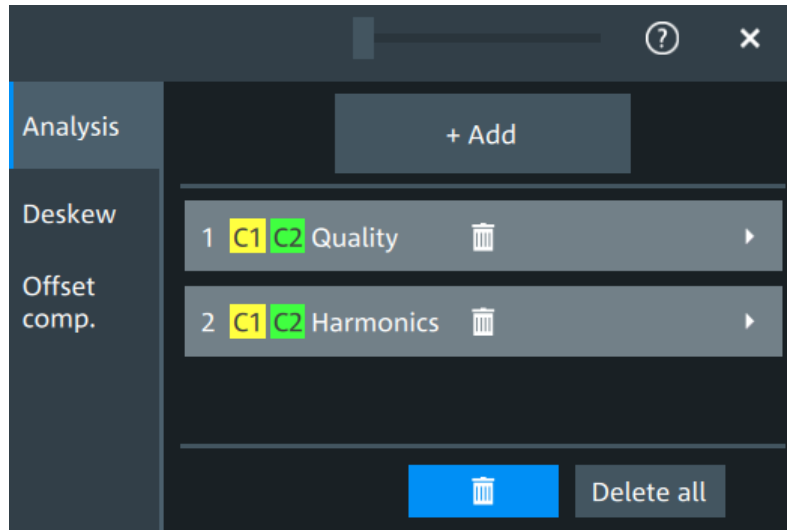

3. Tap on the button of the power measurement that you want to delete. Alternatively, tap "Delete All" to delete all measurements.

11.2.2 Power measurements

11.2.2.1 Power analysis settings

In the "Analysis" you can enable the power analysis and access the dialog to select the power analysis measurements.

You can add up to 6 power analysis measurements. You can also add several instances of the same measurement.

Also you can access the settings dialogs for all enabled power analysis measurements.

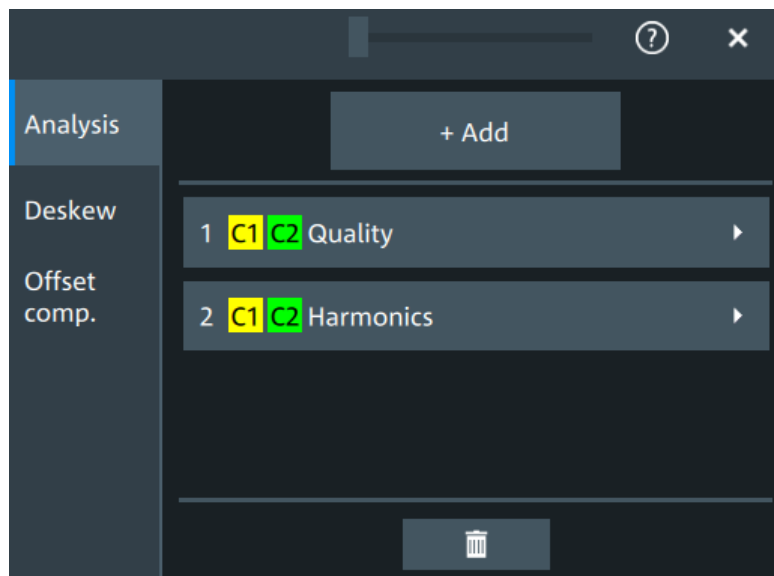

Add

Opens a dialog to select the power analysis measurements.

Available are power quality and power harmonics measurements.

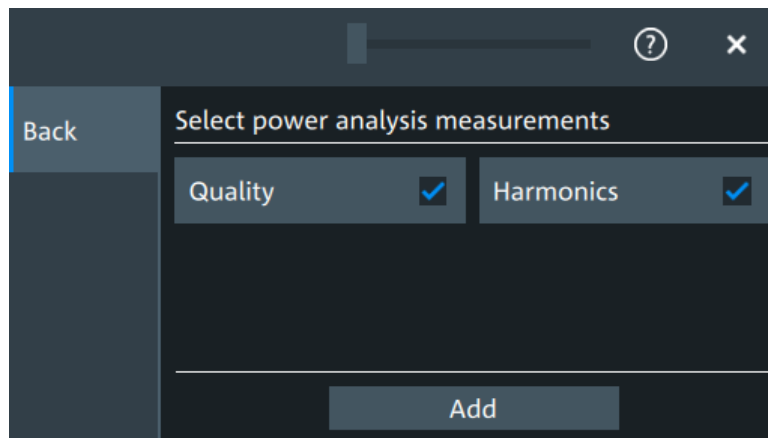

Remote command:

[POWer<m>\[:ENABle\]](#) on page 619

[POWer<m>:TYPE](#) on page 619

11.2.2.2 Power quality

In an electric circuit power is a measure for the rate of flow of energy at a certain point of the circuit. The active power of a circuit, or the energy that can be used for work, is the portion of energy that is transferred in one direction over a complete cycle of the AC waveform. In AC circuits, however, inductive and capacitive elements can store energy temporarily. This portion of the power flow known as reactive power is then returned to the source without doing any work.

The power quality analysis measurements include the active power, the reactive power, the apparent power and the power factor. The crest factors and the phase angle between the current and voltage are also measured. These properties describe the power transfer in the system and allow you to characterize the power quality of the system.

Required probes:

- Differential voltage probe
- Current probe

Configuring power quality

For details of the configuration settings, see "[Power quality settings](#)" on page 251.

1. Add a new power quality measurement as described in "[To add a new power measurement](#)" on page 246.
2. In the "Analysis" tab, tap the "Quality" measurement.
The "Quality" setup dialog opens.

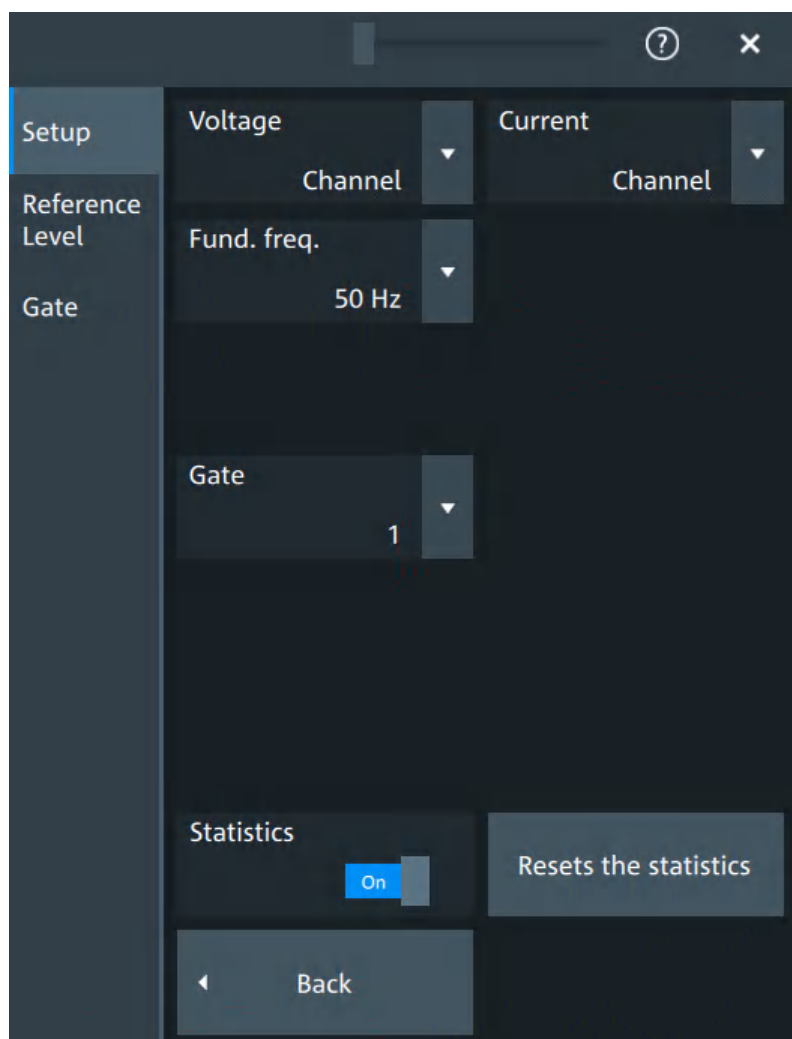

3. Connect the differential voltage probe and the current probe to the oscilloscope.
4. Connect the probes to the DUT:

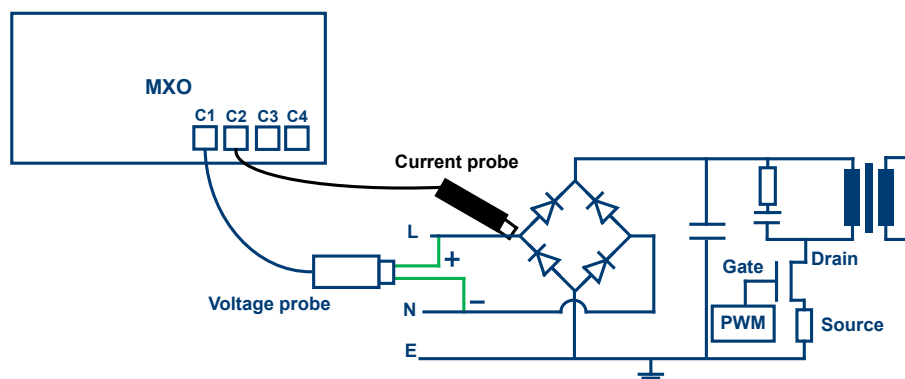

- a) Connect the positive (+) signal socket of the differential voltage probe to the line of the AC input.
 - b) Connect the negative (-) signal socket of the differential voltage probe to the neutral of the AC input.
 - c) Connect the current probe to the line of the AC input.
5. Select the correct channels for the "Voltage" and the "Current" probes.
 6. Set the "Fund. Freq" according to your signal.
 7. If necessary, enable "Statistics".

On the screen, you can see the measurement waveforms of the current, the voltage and the power. Also, the result box with numeric measurement results is shown. For details, see "[Power quality results](#)" on page 253.

Power quality settings

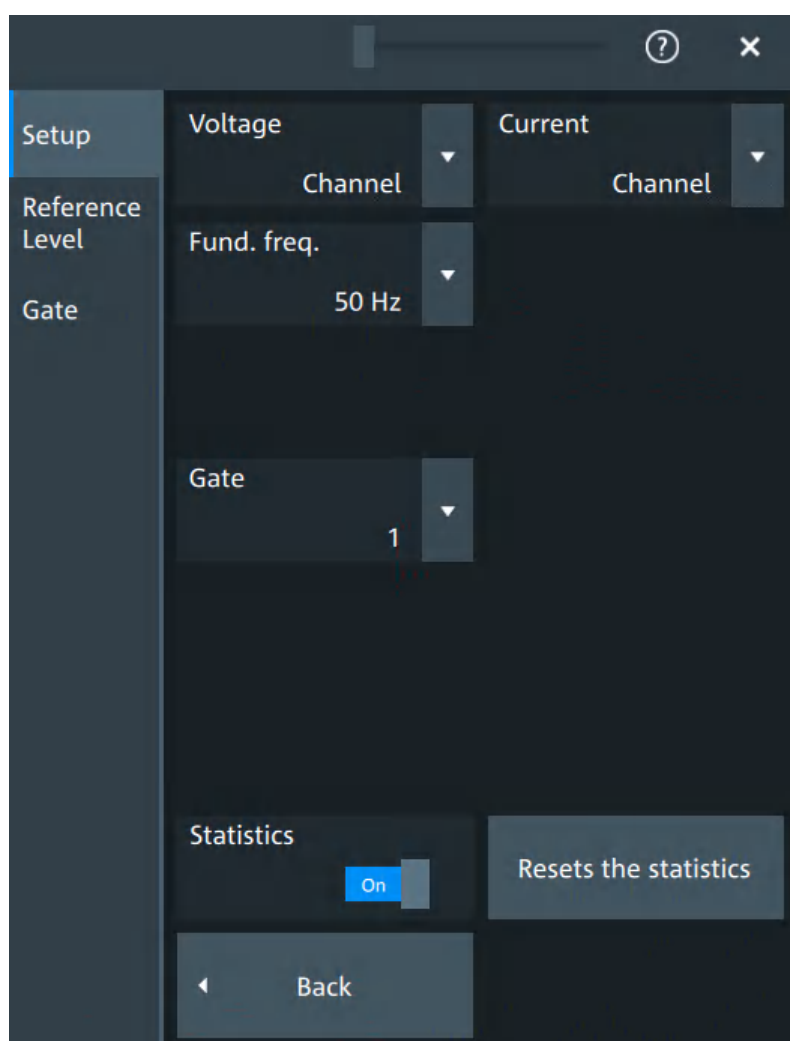

Voltage

Selects the channel for the voltage source.

Remote command:

`POWer<m>:QUALity:SOURce[:VOLTage]` on page 621

Current

Selects the channel for the current source.

Remote command:

`POWer<m>:QUALity:SOURce:CURREnt` on page 620

Fund. Freq

Selects the input frequency of the source signal.

Remote command:

`POWer<m>:QUALity:FREQuency[:VALue]` on page 621

`POWer<m>:QUALity:FREQuency:USER` on page 621

Statistics

Activates or deactivates the statistical evaluation for the power measurement. If statistics are enabled, the following results are calculated:

Label	Description
Current	Current value
Max	Maximum value
Min	Minimum value
Mean	Average
RMS	Root mean square
σ (S-dev)	Standard deviation
Event count	Number of measured events
Wave count	Number of waveforms (acquisitions) the measurement is based on

Resets the statistics

Resets the statistical results for the respective power measurements, and starts a new statistical evaluation if the acquisition is running.

Power quality results



The results of power quality measurements are provided in two ways:

- The diagram shows the graphical presentation of:
 - The voltage waveform
 - The current waveform
 - The power waveform that is the product of the current and voltage waveforms
- The result box displays the numeric measurement results:

Voltage and current results

The voltage and current results are defined as follows:

Result	Description
Current / Voltage RMS	Square root of the mean of the square of the current or voltage averaged over N cycles
Voltage Frequency	Frequency of the signal
Current / Voltage Crest factor	Peak value / RMS value

Power results

The power in a system is described by several physical quantities:

Result	Unit	Formula	Description
Apparent power, S	VA	$ S = V_{RMS} \cdot I_{RMS}$ (averaged over N cycles)	S is the magnitude of the vector sum of active and reactive power (the complex power S).
Reactive power, Q	VAR (Volt-Ampere reactive)	$Q = S \sin \varphi$	Power flow that is temporarily stored in a system because of the inductive and capacitive elements.
Power factor, P_{Factor}	-	$P_{Factor} = P / S $	Measure of the system efficiency. The value varies between -1 and 1.
Active power, P	W	$P = V_{INSTANTENEOUS} \cdot I_{INSTANTENEOUS}$ (averaged over N cycles)	Energy of the system that can be used to do work.
Phase, φ	°	$\varphi = \arccos(P_{Factor})$	Phase angle between the current and the voltage sine waves.

Reference level

For a description of the gate settings, see [Chapter 11.2.3, "Reference level"](#), on page 259.

Gate

For a description of the gate settings, see [Chapter 9.2.2, "Gate settings for measurements"](#), on page 197.

11.2.2.3 Power harmonic

Current harmonics appear in an electric power system due to nonlinear electric loads. The harmonics can be ejected back into the AC line and disturb other equipment on the grid. To avoid this disturbance, there are often standards of compliance that consumer or industry end-products must meet.

The "Harmonics" analysis tests the devices according to the precompliance standards EN 61000-3-2, MIL-STD-1399 and RTCA DO-160.

Required probes:

- Differential voltage probe
- Current probe

Configuring power harmonics

For details of the configuration settings, see ["Power harmonic settings"](#) on page 256.

1. Add a new power quality measurement as described in ["To add a new power measurement"](#) on page 246.
2. In the "Analysis" tab, tap the "Harmonics" measurement.

The "Harmonics" setup dialog opens.

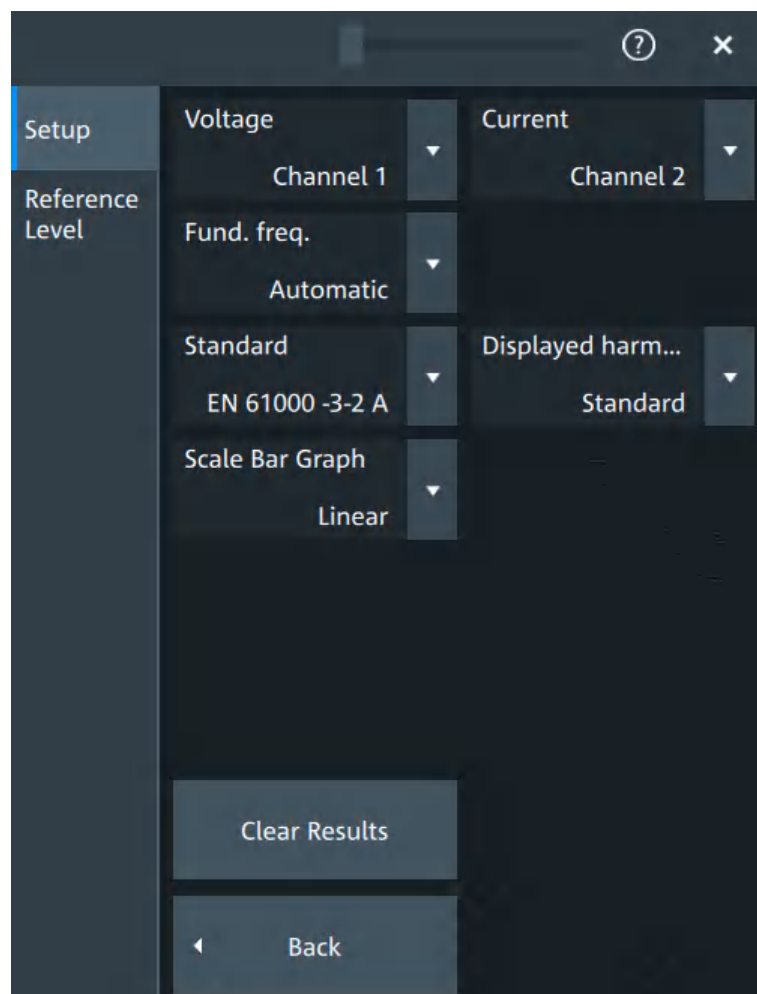

3. Connect the differential voltage probe and the current probe to the oscilloscope.
4. Connect the probes to the DUT:

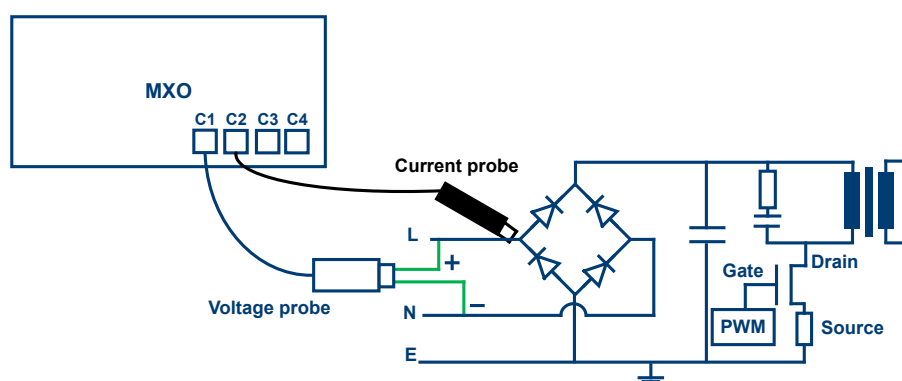

- a) Connect the positive (+) signal socket of the differential voltage probe to the line of the AC input.
 - b) Connect the negative (-) signal socket of the differential voltage probe to the neutral of the AC input.
 - c) Connect the current probe to the line of the AC input.
5. Select the correct channels for the "Voltage" and the "Current" probes.
 6. Select the "Standard".
 7. Select the "Fund. Freq" according to your signal.

On the screen, you can see the measurement of the current, the voltage and the power. Also there is a table giving information about important measurement parameters. For details, see ["Power harmonic results"](#) on page 258.

Power harmonic settings

In this tab, you configure the current harmonic measurement parameters and display settings.

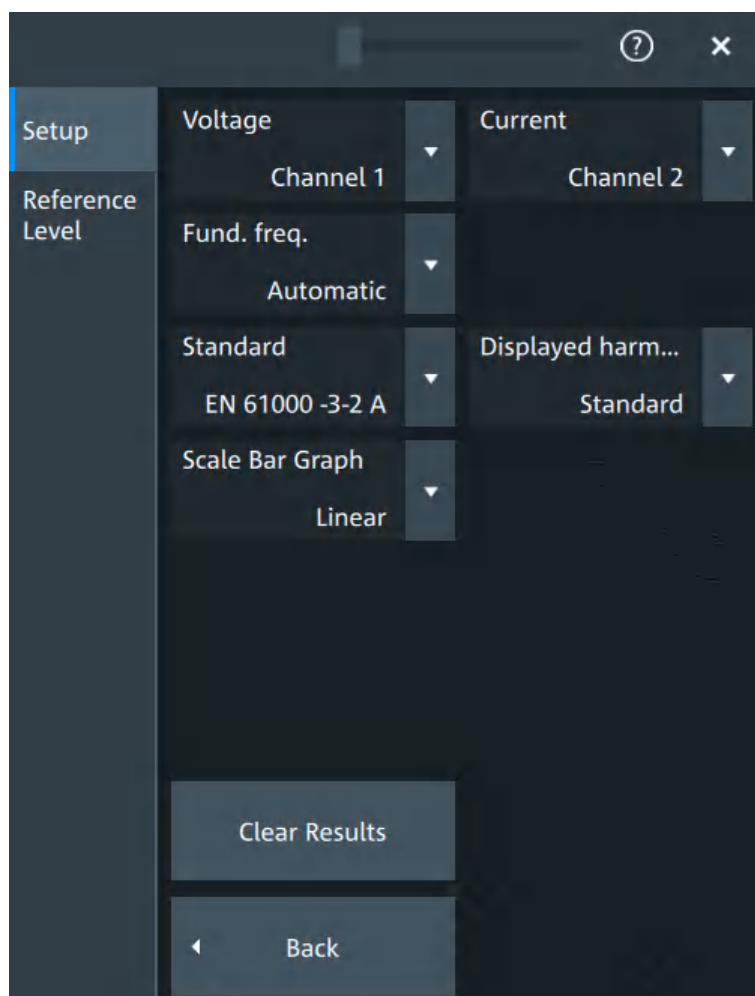

Voltage

Selects the channel for the voltage source.

Remote command:

[POWER<m>:HARMonics:SOURce\[:VOLTagE\]](#) on page 629

Current

Selects the channel for the current source.

Remote command:

[POWER<m>:HARMonics:SOURce:CURRent](#) on page 628

Fund. Freq

Selects the frequency of the input signal. The available frequencies depend on the selected [Standard](#).

Remote command:

[POWER<m>:HARMonics:FREQuency:EN](#) on page 629

[POWER<m>:HARMonics:FREQuency:MIL](#) on page 630

[POWER<m>:HARMonics:FREQuency:RTCA](#) on page 630

Standard

Select the standard in use.

Table 11-1: Current harmonic precompliance standards

Standard	Application
EN 61000-3-2 Class A	Balanced 3-phase equipment, household appliances (excluding equipment identified as class D), tools (excluding portable tools), dimmers for incandescent lamps, audio equipment
EN 61000-3-2 Class B	Portable tools, not professional arc welding equipment
EN 61000-3-2 Class C	Lighting equipment
EN 61000-3-2 Class D	PC, PC monitors, radio, or TV receivers with an input power less than or equal to 600W
MIL-STD-1399	Military shipboard user equipment
RTCA DO-160	Environmental tests of avionics hardware

Remote command:

[POWER<m>:HARMonics:STANdard](#) on page 629

Displ. Harm.

Selects which harmonics are displayed in the bargraph: all, odd even or depending on the standard definition.

Scale bar graph

Selects logarithmic or linear scale for the display for the harmonics bargraph.

Clear Results

Clears all current results and resets the statistics.

Remote command:

POWer<m>:HARMonics:STATistics:RESet on page 630

Power harmonic results

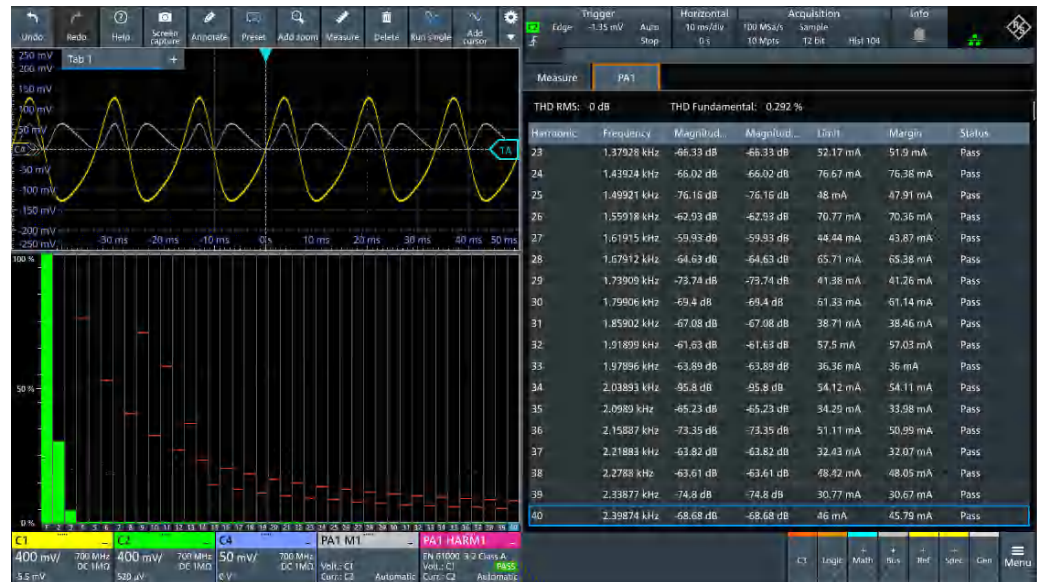

The results of the Harmonic measurements are provided in two ways:

- The diagram shows the graphical presentation of the voltage waveform, the current waveform and the power waveform
- The result box displays a bar chart and a table with the numerical measurement results. The number of displayed harmonics depends on the standard definition. When you tap on a harmonic in the bar chart, the respective row in the result box is displayed.

The current harmonic results displayed in the result box are defined as follows:

Result table	Bar chart match	Description
THDF	-	Total harmonic distortion relative to the fundamental
THDR	-	Total harmonic distortion relative to the RMS amplitude
Harmonic index	Value of the x-axis	The harmonic order
Frequency	-	The frequency value of the signal
Magnitude	Value of the y-axis. Shown by a green bar	The present value of the current harmonic
Magnitude (dB) Max	Shown by a darkened green bar	The maximum measured value
Limit	Shown by a red bar	The maxim allowed value according to the selected standard

Result table	Bar chart match	Description
Margin		Sets the upper limit for the display of the Y scale. This value can be reset with "Clear Results"
Status	Pass: green bar Dark orange bar: current value Light orange bar: maximum value	Displays, if the harmonics is within the defined limit (pass) or not (fail).
Blue outline of the row	Blue bar	The selected bar matches with the outlined line in the result box.

Reference level

The power harmonic measurement requires reference levels to obtain the measurement points. Power analysis uses its own reference level set, which is independent from other measurements and is used for all power measurements. For a description of the reference level settings, see [Chapter 11.2.3, "Reference level"](#), on page 259.

11.2.3 Reference level

Some power analysis measurements require reference levels to obtain the measurement points. Power analysis uses its own reference level set, which is independent from other measurements and is used for all power measurements.

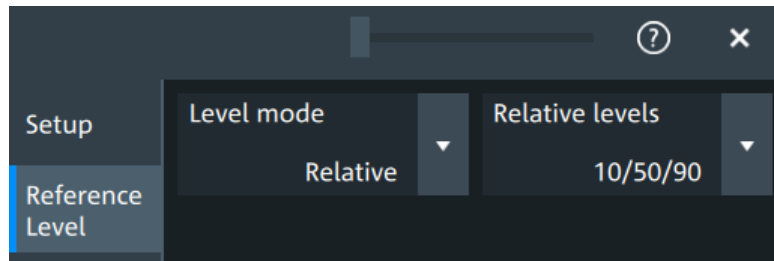

Figure 11-4: Relative reference level

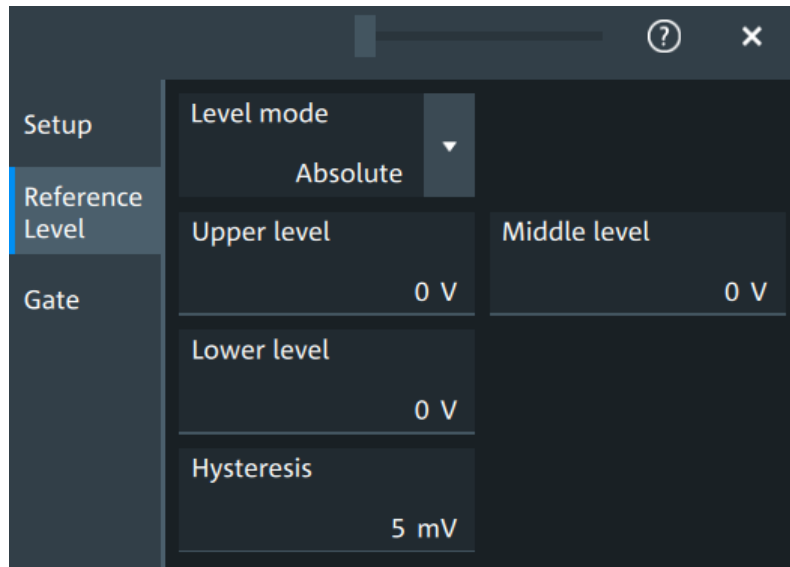

Figure 11-5: Absolute reference level

Level mode

Defines if the reference level is set in absolute or relative values.

Remote command:

[POWER<m>:HARMonics:REFLevel<rl>:LMODe](#) on page 637

[POWER<m>:QUALity:REFLevel<rl>:LMODe](#) on page 637

Absolute Level mode

In the absolute mode, the reference values are set as voltages, in absolute values.

Upper level, Middle level, Lower level ← Absolute Level mode

Sets the low, middle and upper reference signal levels.

Remote command:

[POWER<m>:HARMonics:REFLevel<rl>:ABSolute:LLEVel](#) on page 636

[POWER<m>:HARMonics:REFLevel<rl>:ABSolute:MLEVel](#) on page 636

[POWER<m>:HARMonics:REFLevel<rl>:ABSolute:ULEVel](#) on page 636

[POWER<m>:QUALity:REFLevel<rl>:ABSolute:LLEVel](#) on page 636

[POWER<m>:QUALity:REFLevel<rl>:ABSolute:MLEVel](#) on page 636

[POWER<m>:QUALity:REFLevel<rl>:ABSolute:ULEVel](#) on page 636

Relative Level mode

In the relative mode, the reference values are set as percentages of the signal amplitude.

Relative levels ← Relative Level mode

Selects the lower, middle and upper reference levels, defined as percentages of the signal amplitude.

Available relative levels:

- 5/50/95

- 10/50/90
- 20/50/80
- User defined: Enter "Upper level", "Middle level", and "Lower level".

For example, for "5/50/95" the levels are set to the following values:

- Lower level = 5% of the signal amplitude
- Middle level = 50% of the signal amplitude
- Upper level = 95% of the signal amplitude

Remote command:

`POWer<m>:HARMonics:REFLevel<rl>:RELative:MODE` on page 638

`POWer<m>:QUALity:REFLevel<rl>:RELative:MODE` on page 638

Upper level, Middle level, Lower level ← Relative Level mode

Define the reference levels in percent, if "Level mode" is set to "User-defined".

Remote command:

`POWer<m>:HARMonics:REFLevel<rl>:RELative:LOWer` on page 638

`POWer<m>:HARMonics:REFLevel<rl>:RELative:MIDDLE` on page 638

`POWer<m>:HARMonics:REFLevel<rl>:RELative:UPPer` on page 639

`POWer<m>:QUALity:REFLevel<rl>:RELative:LOWer` on page 638

`POWer<m>:QUALity:REFLevel<rl>:RELative:MIDDLE` on page 638

`POWer<m>:QUALity:REFLevel<rl>:RELative:UPPer` on page 639

Hysteresis

Defines a hysteresis for the middle reference level. A rise or fall from the middle reference value that does not exceed the hysteresis is rejected as noise.

Remote command:

`POWer<m>:HARMonics:REFLevel<rl>:RELative:HYSTeresis` on page 637

`POWer<m>:HARMonics:REFLevel<rl>:ABSolute:HYSTeresis` on page 635

`POWer<m>:QUALity:REFLevel<rl>:RELative:HYSTeresis` on page 637

`POWer<m>:QUALity:REFLevel<rl>:ABSolute:HYSTeresis` on page 635

11.2.4 Deskew

In the dialog box you can perform a deskew of your current and voltage probes.

Required equipment:

- R&S RT-ZF20 power deskew fixture
- Rohde & Schwarz voltage probe
- Rohde & Schwarz current probe

11.2.4.1 Deskew settings

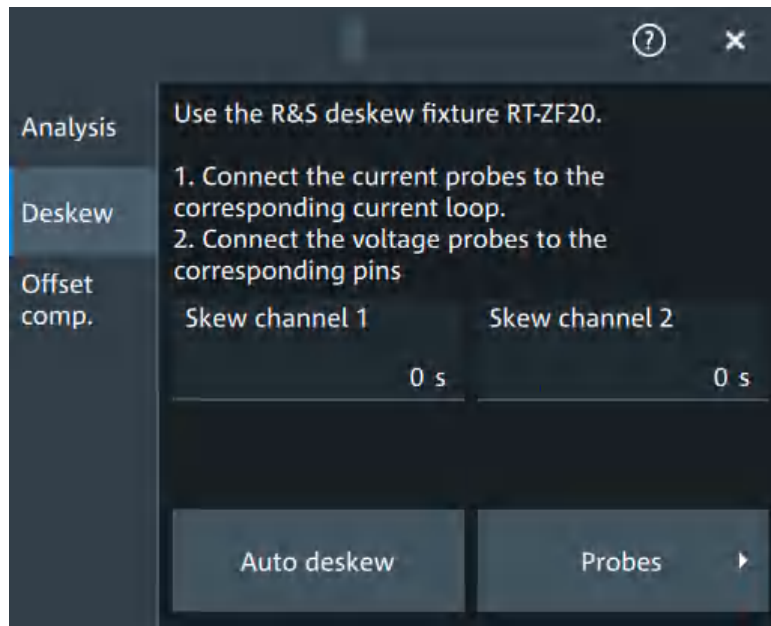

Skew channel

Sets user-defined skew settings for the channel connected to the current probe. Alternatively, you can start an "Auto Deskew".

Auto Deskew

Starts an auto deskew. It is used to determine the trigger and scaling properties.

For an auto deskew, only Rohde & Schwarz probes are supported.

Make sure that the probes are configured correctly before you start the deskewing.

After the deskew, the result values are written in the "Skew" value of the corresponding channel.

If there are more than two active channels, you can perform automatic deskew step by step and exchange the probes connected fixture between the steps.

Remote command:

`POWer<m>:ASKew[:EXECute]` on page 620

11.2.5 Offset compensation

The offset compensation adjustments are applied to all power analysis measurements.

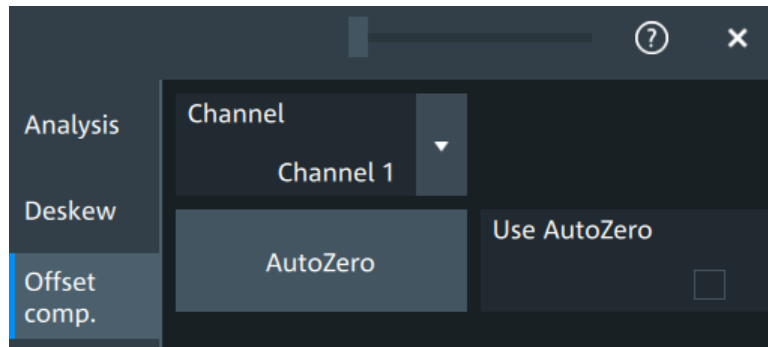

Channel

Select the channel for the offset compensation.

AutoZero, Use AutoZero

Differences in DUT and oscilloscope ground levels can cause larger zero errors, which affect the waveform. If the DUT is ground-referenced, the AutoZero function corrects the zero error of the probe to optimize measurement results at small signal levels. The validation limit depends on the probe attenuation because probes with high attenuation often have to compensate high offsets. AutoZero detects offset values even when the signal is out of the current measurement range.

To correct the zero error of voltage probes, short the signal pin and the ground pin together and connect them to the ground of the DUT. Then tap "AutoZero". While the alignment is running, the instrument switches to DC coupling to display the waveform correctly.

To include the measured offset in measurement results, enable "Use AutoZero".

If a current probe is connected, the function demagnetizes the probe's sensor head and sets the waveform to zero position.

Remote command:

[PROBe<ch>:SETup:OFFSet:AZERo](#) on page 479

[PROBe<ch>:SETup:OFFSet:USEautozero](#) on page 479

11.3 Digital voltmeter

The software-based voltmeter features AC RMS, DC and DC RMS voltage measurements on a specific analog channel.

11.3.1 Using the digital voltmeter

To start a digital voltmeter measurement

1. Tap the "Menu" > "Apps" > "General" tab > "DVM", to open the digital voltmeter measurement dialog.



2. Select the channel for your measurement.
3. Select a "Filter bandwidth" from the list.
4. Set a "Measurement time".
5. Tap on a measurement to enable it. Available are "DC", "DC RMS", "AC RMS".

The measurement results of all enabled measurements are displayed in a result box.



11.3.2 Settings of the digital voltmeter

Access: "Menu" > "Apps" > "General" tab > "DVM".

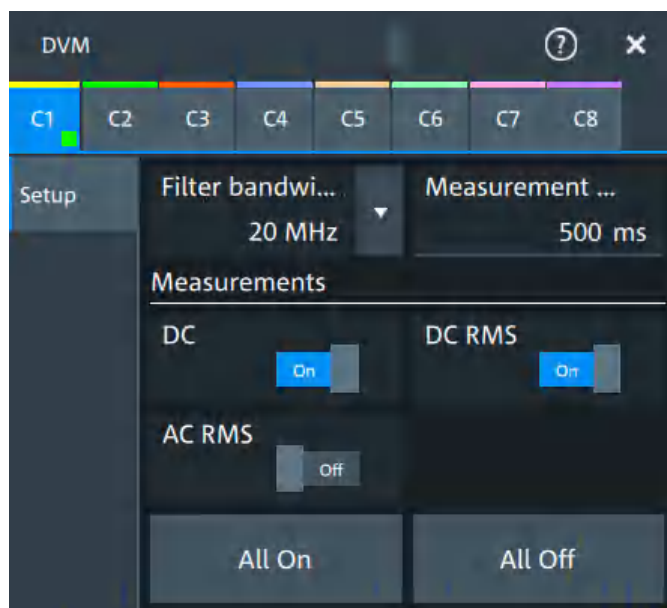
**C<n>**

Selects the channel which is measured by the digital voltmeter.

Filter bandwidth

Selects the filter bandwidth.

Remote command:

[METER:BANDwidth](#) on page 642

Measurement time

Sets a measurement time. The time begins in the moment that a measurement is enabled.

Measurements

Enables the voltmeter measurements. When a measurement is enabled, the voltmeter is turned on automatically.

"DC" Enables the DC voltage measurement.

"DC RMS" Enables the DC RMS voltage measurement.

"AC RMS" Enables the AC RMS voltage measurement.

Remote command:

[METER:DVMeter<m>:ACRMs:ENABle](#) on page 642

[METER:DVMeter<m>:ACRMs:RESult?](#) on page 642

[METER:DVMeter<m>:DC:ENABle](#) on page 643

[METER:DVMeter<m>:DC:RESult?](#) on page 643

[METER:DVMeter<m>:DCRMs:ENABle](#) on page 643

[METER:DVMeter<m>:DCRMs:RESult?](#) on page 644

All on, All off

Enables/disables all voltmeter measurements.

12 Data and file management

This chapter describes how to manage instrument settings, waveform data, measurement results, and screenshots.

The "Save/Recall" dialog provides functions for saving and restoring data on the instrument.

Access to saving settings and data: "Menu" key > "Save/Recall" key > "Save" tab.

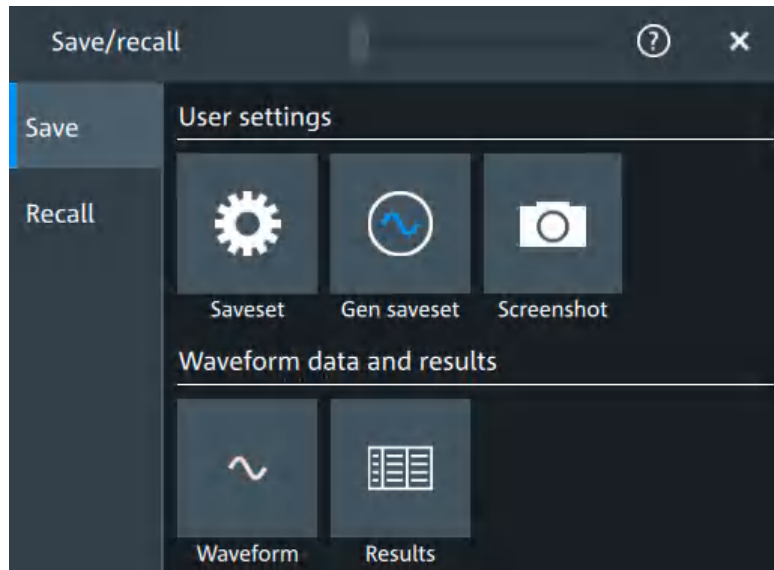

Figure 12-1: Save tab

Access to loading settings and data: "Menu" key > "Save/Recall" key > "Recall" tab.

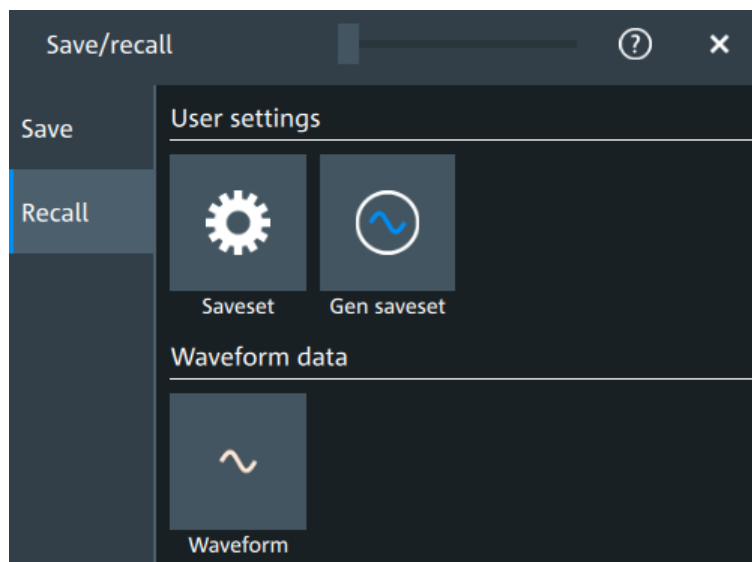

Figure 12-2: Recall tab

Using the "Save/Recall" dialog, you can store or load various data to files for further usage, analysis and reporting:

- Instrument settings: [Chapter 12.1, "Save and recall user settings"](#), on page 267
- Waveforms: [Chapter 12.2, "Save and recall waveform data"](#), on page 271
- Screenshots: [Chapter 12.4, "Screenshots"](#), on page 280
- Reference waveforms: [Chapter 12.2, "Save and recall waveform data"](#), on page 271 and [Chapter 8.4, "Reference waveforms"](#), on page 176
- Measurement results: [Chapter 12.3, "Saving results"](#), on page 279

The [Camera] key can be configured to save or set up screenshots.

Storage locations

You can store data directly on the instrument, or to a USB flash drive. For local storage, the path is always `home/storage/userData`. The path has subdirectories to organize the data. For storage on USB flash drive, the default path is `/run/media/usb/`. On both storage media, you can create directories to organize the data. You can also copy, paste and delete data.

On USB flash drives, the following file systems are supported: FAT32 and NTFS.

12.1 Save and recall user settings

To repeat measurements at different times or perform similar measurements with different test data, you can save the used instrument settings and load them again later. Furthermore, you can refer to the instrument settings of a particular measurement when analyzing the results. Optionally, the current toolbar and dialog configuration can be included into the saveset.

Access: "Menu" key > "Save/Recall" key > "Save" tab > "User settings".

If you often save and load instrument settings, try the following shortcuts:

- The "Save setup" toolbar icon saves the current settings to a file according to the settings in "Save/Recall" key > "Save".
- The "Recall" toolbar icon opens the dialog to select and load a setup.
- You can assign a saveset to the [Preset] key and the "Preset" function on the toolbar, see [Chapter 5.6, "Preset setup"](#), on page 88.

12.1.1 Using savesets

Savesets contain the complete instrument and measurement configuration. You can save an unlimited number of setting files.

To save settings to a saveset file

1. Open "Menu" > "Save/Recall".
2. In the "Save" tab, tap the "Saveset" button.

The save "Saveset" dialog opens.

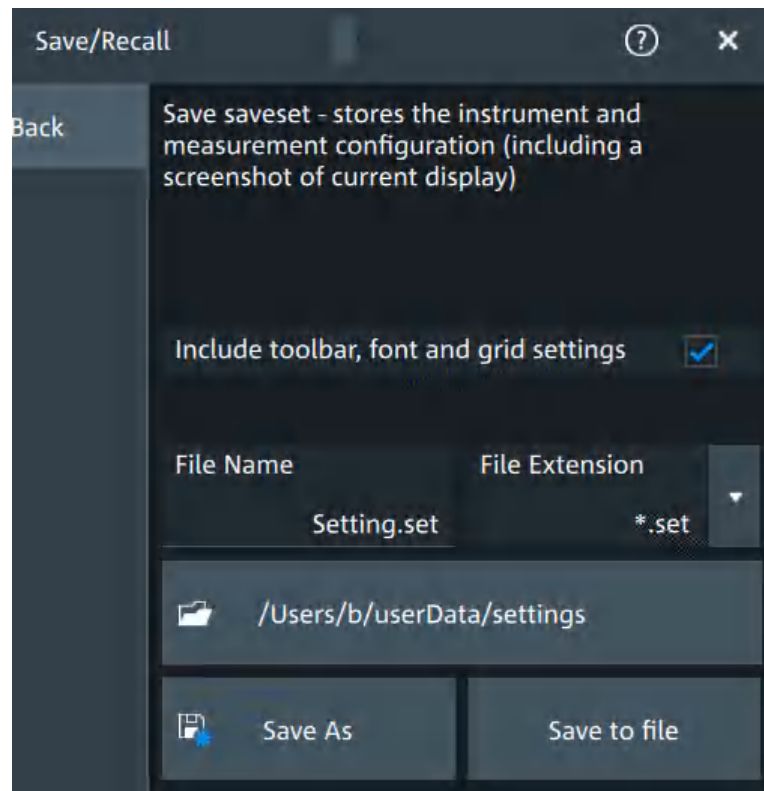

Figure 12-3: Save saveset dialog

3. If needed, enable "Include toolbar, font and grid settings".
4. Check the path on the "Directory" button. If the path does not fit, tap the button. Navigate to the folder, where you want to save the settings file.
5. Tap "Save to file".
Alternatively, select "Save As" and select the destination folder and file name in the file selection dialog.

The current settings are saved to the selected file.

To load settings from a saveset file

1. Open "Menu" > "Save/Recall".
2. In the "Recall" tab, press the "Saveset" button.

The recall "Saveset" dialog opens.

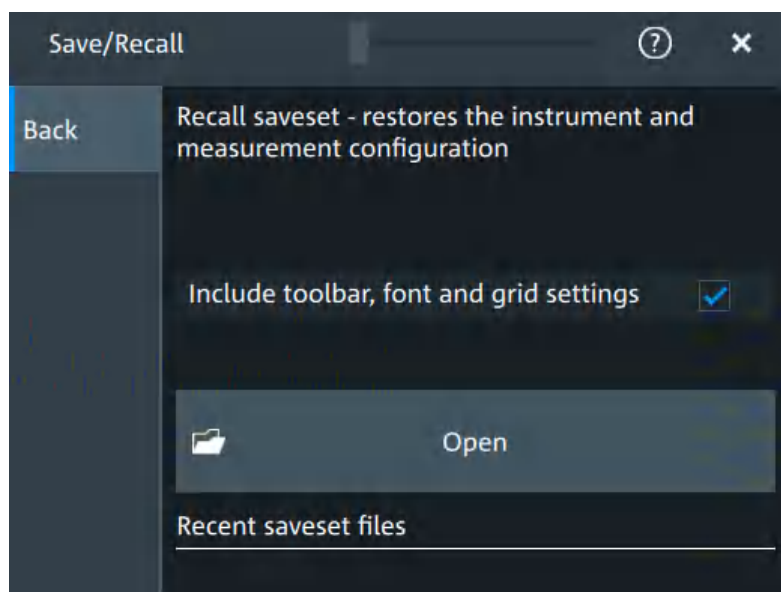

Figure 12-4: Recall saveset dialog

3. Tap "Open".
4. Navigate to the required saveset.
The saved settings are loaded to the R&S MXO 5.

12.1.2 Gen saveset

Generator savesets store the instruments generator configuration.

To save settings to a saveset file

1. Open "Menu" > "Save/Recall".
2. In the "Save" tab, press the "Gen saveset" button.
The save "Gen saveset" dialog opens.

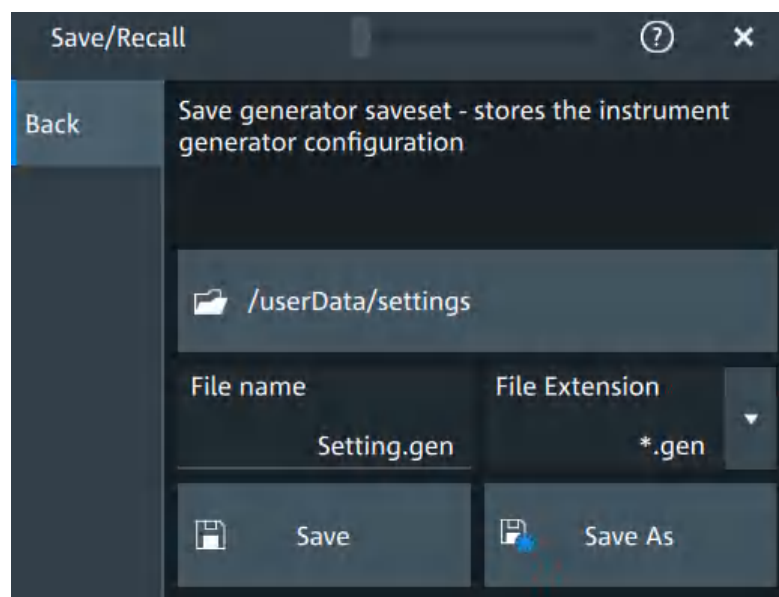

Figure 12-5: Save generator saveset dialog

3. Tap "Browse"

The current settings are saved to the selected file.

To load settings from a saveset file

1. Open "Menu" > "Save/Recall".
2. In the "Recall" tab, press the "Gen saveset" button.
The recall "Gen saveset" dialog opens.

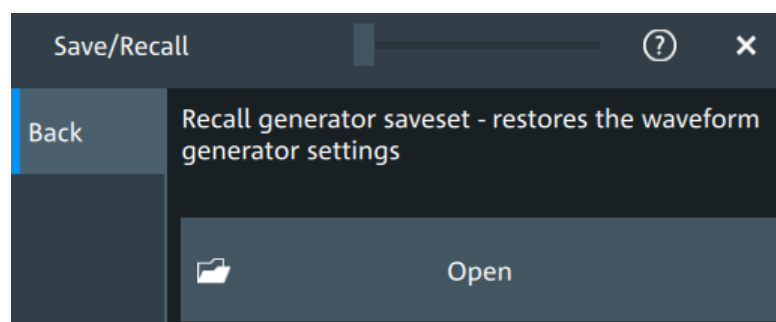

Figure 12-6: Recall generator saveset dialog

3. Tap "Open".
4. Navigate to the saveset.
The saved settings are loaded to the R&S MXO 5.

Remote commands:

- [GENerator:SAV](#) on page 550

- [GENerator:RCL](#) on page 550

12.2 Save and recall waveform data

You can save waveform data to file, and reload the data of REF files as reference waveforms.

12.2.1 Waveform settings

Access: "Menu" > "Save/Recall" > "Save" tab > "Waveform".

In this dialog, you define the storage settings for waveform data.

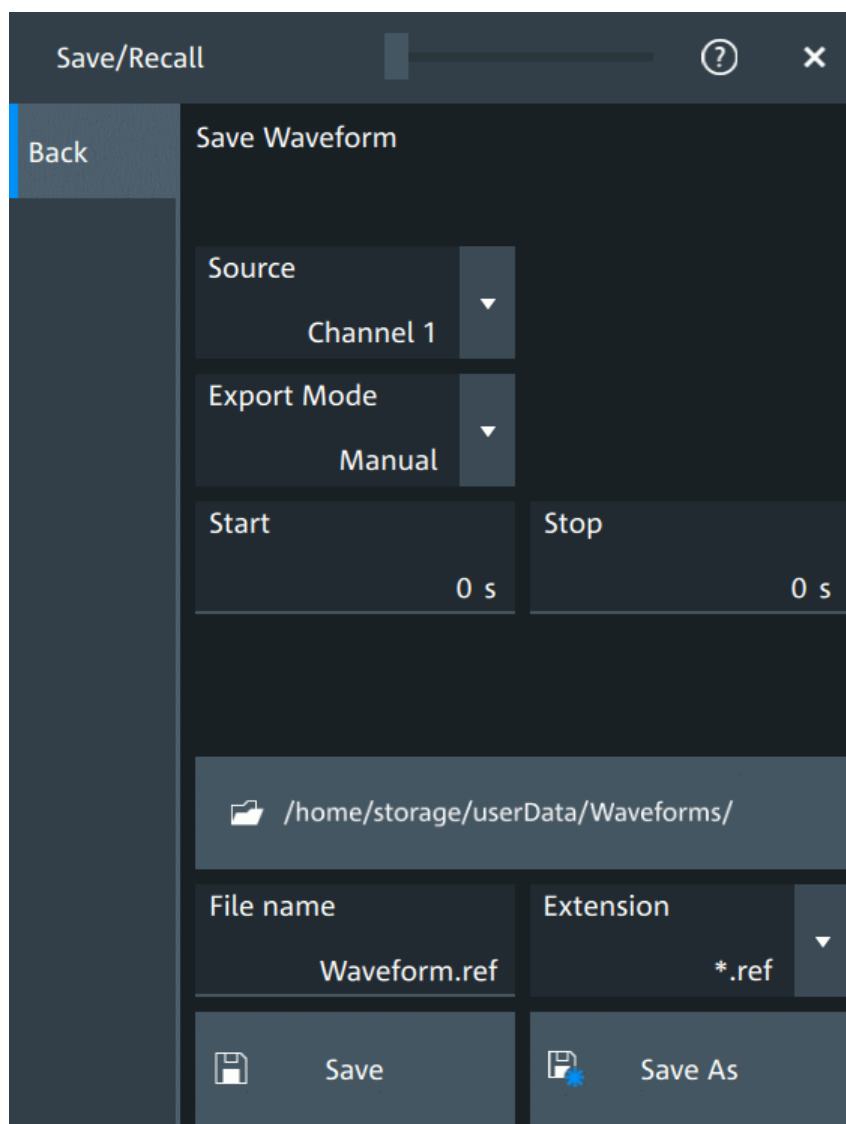

Source

Selects the waveform to be exported. The list shows all active waveform that can be exported.

Remote command:

[EXPort:WAVeform:SOURce](#) on page 552

Export mode

Defines the part of the waveform record that has to be stored.

"Display"	Saves the waveform data that is displayed in the diagram.
"All data"	Saves the complete waveform record.
"Cursor"	Saves the data between the cursor lines if at least one cursor measurement is defined for the source waveform. If several cursor sets are defined, select the "Cursor set" to be used for export.
"Gate"	Saves the data included in the measurement gate if a gated measurement is defined for the source waveform. Select the "Gate" to be used for export.
"Manual"	Saves the data between user-defined "Start" and "Stop" values.

Remote command:

[EXPort:WAVeform:SCOPE](#) on page 551

[EXPort:WAVeform:CURSORset](#) on page 553

[EXPort:WAVeform:GATE](#) on page 553

[EXPort:WAVeform:START](#) on page 552

[EXPort:WAVeform:STOP](#) on page 553

Save settings

Defines the details of the filename, extension and directory.

"File name"	Sets a name for the file, without extension.
"Extension"	Selects the format of the exported file. You can select between "Excel-CSV-File (*.csv)" and a "Reference Waveform Format (*.ref)". REF files can be reloaded as reference waveforms. See also: Chapter 12.2.3, "Waveform export files" , on page 274.
"Directory"	Opens a file explorer where you can select the directory where the file is saved.
"Save as"	Opens a file explorer where you can select the directory and enter the filename.
"Save"	Saves the file in the defined "Directory" using the defined "File name". If the specified file already exists, it is overwritten with the new data.

A progress bar informs you about the process, see ["Progress information"](#) on page 66.

Remote command:

[EXPort:WAVeform:NAME](#) on page 551

[EXPort:WAVeform:SAVE](#) on page 551

12.2.2 Saving waveforms

To save a waveform

1. Open "Menu" > "Save/Recall".
2. In the "Save" tab, tap "Waveform".

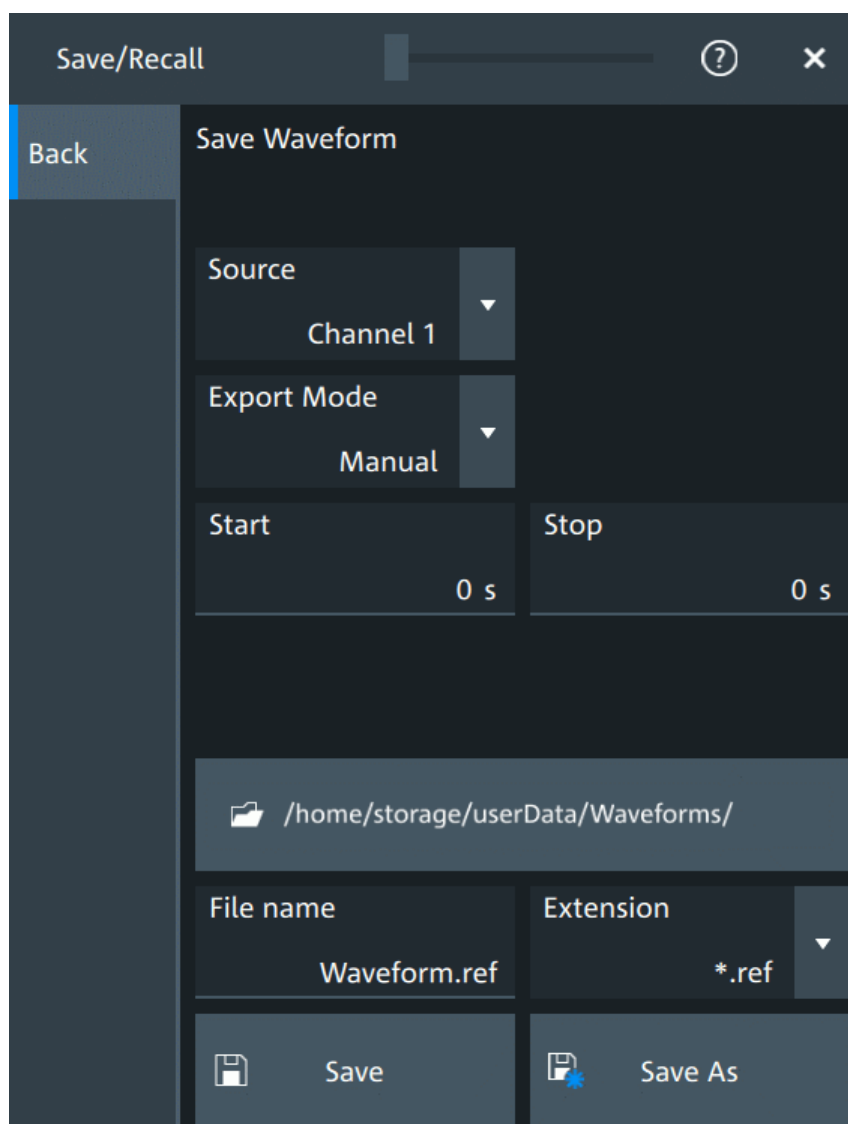

Figure 12-7: Save waveform dialog

3. Select the "Source".
4. Select the "Export mode" to define the part of the waveform to be exported.
5. If necessary, define the cursor, gate or start/stop values for the data.
6. Select the format of the export file: "Extension".

7. Set the "File name".
8. Tap "Save" or "Save as".

The current waveform is saved to the selected file. A progress bar informs you about the saving process.

12.2.3 Waveform export files

Waveform data is stored in excel `*csv` format, or in a specific `*.ref` format. Files in `*.ref` format can be reloaded as reference waveforms.

12.2.3.1 CSV files

A `*csv` file is a comma-separated values (CSV) text file, the waveform is stored in a table. The columns are separated by commas. For each sample, one line is written. Values are listed in scientific notation. You can convert the comma-separated text to columns.

Content of waveform files

The first lines of the file contain header data, for example, time scale, vertical scale, vertical and horizontal positions. Header data is required to interpret the waveform data, and to analyze the data values of the data file.

Below the header, the waveform data follows. For each sample, one line is written. The first value is the X-value (time or frequency), the next is the Y-value in the unit indicated in the header data. For envelope or peak detect waveforms, two Y-values (minimum and maximum) are written for each sample.

	A	B	C	D	E	F	G	H
1	Model,MXO44							
2	SerialNumber,900008							
3								
4	SourceType,CHANNEL_TRACE							
5	SignalSource,Ch1Wfm1							
6	Resolution,2.0000000000000001e-10							
7	RecordLength,1000							
8	HWRRecordLength,1000							
9	HorizontalPosition,0							
10	TraceArithmetics,SINGLE							
11	BaseUnit,LEVEL_V							
12	BaseUnitRelative,OFF							
13	Impedance,50							
14	XStart,-9.9999999999999995e-08							
15	XStop,9.9999999999999995e-08							
16	TimebaseScale,2e-08							
17	ReferencePoint,50							
18	VerticalPosition,0							
19								
20								
21								
22								
23								
24								
25								
26								
27								
28								
29								
30								
31								
32								
33								
34								
35								
36								
37								
38								
39								
40								
41								
42								
43	TIME,C1							
44	-1.05e-07,-0.053750305399462489							
45	-1.048e-07,-0.051307109699486923							
46	-1.046e-07,-0.049719032494502803							
47	-1.044e-07,-0.048253115074517461							
48	-1.0419999999999999e-07,-0.045443440019545561							
49	-1.0399999999999999e-07,-0.042267285609577321							
50	-1.0379999999999999e-07,-0.039824089909601755							
51	-1.0359999999999999e-07,-0.037860533310621301							

Figure 12-8: CSV file, opened in Excel

Header data

The header lines contain the following properties:

Table 12-1: Header file properties in CSV files

Value	Description
Model	Model of the instrument
SerialNumber	Serial number of the instrument
SourceType	Type of the exported waveform
SignalSource	Source of the exported waveform
Resolution	Time between two samples <i>Resolution = 1 / Sample Rate</i>
RecordLength	Number of samples in a waveform record of one acquisition
HWRRecordLength	Equivalent to the RecordLength
HorizontalPosition	Horizontal position of the waveform in divisions
TraceArithmetics	Waveform arithmetic of the waveform: off, envelope, or average
BaseUnit	Base unit of a mathematic waveform, for example, linear unit
BaseUnitRelative	Base unit, if a relative unit (e.g. dB) is enabled
Impedance	Input impedance, used for power calculation

Value	Description
XStart	Horizontal start value of the waveform (time or frequency), as defined in the export settings
XStop	Horizontal stop value of the waveform (time or frequency), as defined in the export settings
TimebaseScale	Horizontal scale in seconds per division
ReferencePoint	Position of the zero point in % of the screen
VerticalPosition	Vertical position of the waveform in divisions
VerticalScale	Vertical scale of the waveform
VerticalOffset	Vertical offset of the waveform in Volts, or other unit
BaseYStart	Vertical start value of the waveform
BaseYStop	Vertical stop value of the waveform
ViewUnit	User-selected unit of a mathematic waveform, for example, logarithmic unit for a spectrum. The value is only valid if the exported waveform is a math waveform.
ViewUnitRelative	Indication of a relative unit. It is true if the math waveform has the ViewUnit "dB", for example. The value is only valid if the exported waveform is a math waveform.
ViewReferenceLevel	Reference level for a relative unit. The value is only valid if the exported waveform is a math waveform, and the unit is relative.
NumericFormat	Number format of bus values and digital channel data (bit pattern format)
EnhancementMode	Method to increase the sample rate if the required sample rate is higher than the ADC sample rate.
InterpolationMode	Interpolation method. The value is relevant when the enhancement mode is interpolated time.
CenterFreq	Center frequency of the spectrum
FreqSpan	Frequency span of the spectrum
ResolutionBW	Resolution bandwidth of the spectrum
FrequencyStart	Start frequency of the spectrum
FrequencyStop	Stop frequency of the spectrum
WindowType	Window used for the spectrum computation
GateRBWCoupling	Indication whether the record length or the resolution bandwidth is a constant for the spectrum computation
HorizontalDivisionCount	Number of horizontal divisions
VerticalDivisionCount	Number of vertical divisions
FirmwareVersion	Firmware version that is installed on the R&S MXO 5
XAxisMode	Indicates a linear or logarithmic x-axis

12.2.3.2 Reference waveforms

The REF format is a specific format, which allows you to reload the waveform data as reference waveform. The data is saved in a zipped file that contains two files. One file is a binary file (BIN file) and contains the waveform data values. The second file is an XML file and contains the header data in several data groups. Header data is required to reload the waveform from data, or to analyze the data values of the data file.

```
<?xml version="1.0" encoding="UTF-8"?>
<Group Name="SignalExportBase">
  <Group Name="SignalAttributes">
    <Prop Name="SourceType" Value="CHANNEL_TRACE" UserValue="NONE" />
    <Prop Name="SignalSource" Value="Ch1Wfm1" />
    <Prop Name="Resolution" Value="2.0000000000000001e-10" />
    <Prop Name="RecordLength" Value="1000" />
    <Prop Name="HWRecordLength" Value="1000" />
    <Prop Name="HorizontalPosition" Value="0" />
    <Prop Name="TraceArithmetics" Value="SINGLE" UserValue="SINGLE" />
    <Prop Name="BaseUnit" Value="LEVEL_V" UserValue="LEVEL_V" />
    <Prop Name="BaseUnitRelative" Value="OFF" UserValue="OFF" />
    ...
  </Group>
  <Group Name="PostProcessingBufferSampleCounts">
    <Prop Name="DeltaPreSamples" Value="25" />
    <Prop Name="PreSamples" Value="500" />
    <Prop Name="PostSamples" Value="500" />
    <Prop Name="DeltaPostSamples" Value="29" />
  </Group>
</Group>
</Group>
```

Figure 12-9: Header file in XML format, part of the REF file container

Table 12-2: Header file properties in REF files

Value	Description
SignalAttributes	
Same values as in CSV files, except for Model and SerialNumber. See Table 12-1 .	
SignalAttributesPostProcessing	
SignalFormat	Format of the data values in the BIN file: INT8BIT, INT16BIT, INT32BIT, FLOAT, DOUBLE
Origin	WFM_EXPORT: export of one acquisition
ByteOrder	Byte order of the values in the BIN file <ul style="list-style-type: none"> • LSB first: little endian, least significant byte first • MSB first: big endian, most significant byte first
NumberOfWaveforms	Number of waveforms, = 1
TimestampState	OFF
Timestamp	Absolute time of the waveform recording in ISO 8601 format
DecimationMode	Method to reduce the number of data samples to achieve the required sample rate
IsMinMax	If ON, then min and max values are saved for each sample. For envelope and peak detect waveforms.
IsComplex	If ON, then two values are saved for each sample (I and Q value).

Save and recall waveform data

Value	Description
TriggerOffsetToPostSampleInSeconds	Offset between the exact trigger position and the first sample after the trigger
SignalRecordLength	Number of samples in the BIN file. If the signal is a spectrum, the value indicates the number of FFT bins.
SignalXStart	Time of the first sample in the acquired data. Different from XStart if only part of the data is exported.
SignalXStop	Time of the last sample in the acquired data. Different from XStop if only part of the data is exported.
AdjustedResolutionBW	Actual resolution bandwidth of a spectrum waveform. Only valid if the exported waveform is a spectrum.
NoiseBandwidth	Noise bandwidth of a spectrum waveform, required for power calculation. Only valid if the exported waveform is a spectrum.
ValuesPerSample	Number of y-values saved at each sampling time. The value is usually 1. The value is 2, if min and max values are saved for each sample, for example, for envelope waveforms.
NofQuantisationLevels	Number of quantization levels of y values
TOADone	If ON, then TriggerOffsetToPostSampleInSeconds is compensated.
SignalResolution	Time between two samples in this waveform. The value can differ from Resolution if the source is, for example, a spectrum. The value is determined automatically considering the waveform parameters and their dependencies. If the signal is a spectrum, the value indicates the frequency range of FFT bins.
HorizontalDomain	Domain of the x-axis (TIME or FREQUENCY)
PostProcessingVerticalAxisAttributes	
Range	Range of the signal in y-direction
Offset	Center of the y-range
Resolution	Resolution of the y-axis
IsLogarithmic	Indicates if the y-axis is logarithmic (ON or OFF)
PostProcessingSampleFormatAttributes	
ValueStorage	Interpretation of the data: is INTEGER or FLOAT (floating point data)
ValueInterpretation	Indicates if the data is saved as binary ADC values (BINARY), or physical values (PHYSICAL)
SampleBitSize	Value size in bit, as used in processing
ValueBitSize	Value size of ADC data in bit
LsbExtensionBits	Number of bits the ADC value is shifted to the left in the CPU sample size
AdcValueBitSize	Number of bits of the ADC that was used to sample the signal. It does not include any additionally gained bits due to high definition mode.
IsSigned	Signed values (ON) or unsigned values (OFF)

Value	Description
PostProcessingBufferSampleCounts	
[DeltaPreSamples PreSamples PostSamples DeltaPostSamples]	Indicates the distribution of the samples. marks the trigger time. The sum of PreSamples and PostSamples matches the requested record length. DeltaSamples are additional samples that needed for computation but they are not measured or displayed.

Note: FractionalBits was removed in FW version 1.3.x. Reference waveforms created with older FW version are compatible and can be reloaded.

12.3 Saving results

In this tab, you can select the result tables to be saved, and define the storage settings.

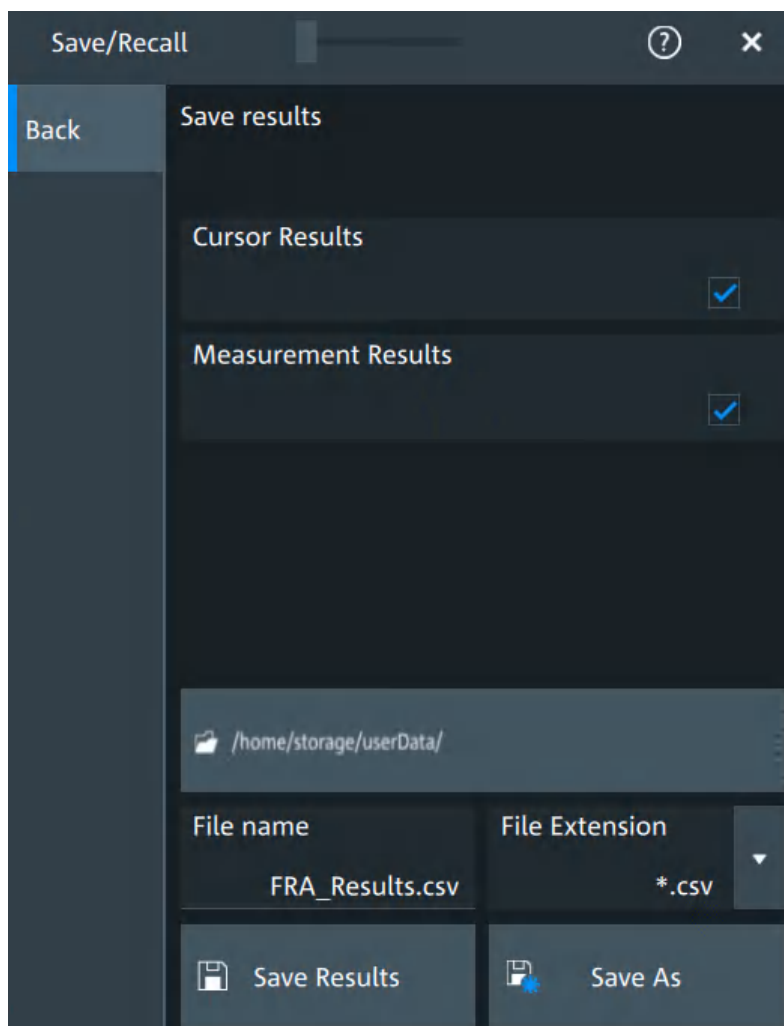

To save results

1. Open "Menu" > "Save/Recall".
2. In the "Save" tab, press the "Results" button.
The save "Results" dialog opens.
3. Select the results to be saved. The "Save results" results list shows all result tables that are currently open. All results are written into one file.
4. Under "Location", enter a "File name" and select "Save". Alternatively, select "Save As" and define the target directory and file name in the file selection dialog.
The current results are saved to the selected file.

Remote commands:

- [EXPort:RESult:SElect:CURSor](#) on page 554
- [EXPort:RESult:SElect:MEASurement](#) on page 554
- [EXPort:RESult:NAME](#) on page 553
- [EXPort:RESult:SAVE](#) on page 554

12.4 Screenshots

To store the graphical results of the measurement, you can save a screenshot of the graphic area. To document current settings, the open dialog box can be included in the screenshot.

If you often save screenshots, try the following shortcuts:

- The "Screen capture" toolbar icon saves the current display to a file according to the settings in "Menu" > "Save/Recall" > "Save" tab > "Screenshot".
- You can configure the [Camera] key to save screenshots by a single keypress. See also "[Camera hardkey action](#)" on page 87.

If a USB flash drive is connected to the instrument, the default path of the user data directory is set to the USB flash drive. Thus, you save data to USB flash drive automatically, and you can change the directory in the file explorer at any time.

Screenshots on a computer using the Web interface

If the R&S MXO 5 is connected to a LAN, you can create and save screenshots of the instrument's display on a computer.

Meta information in screenshots

The meta data of the screenshot also contains instrument information. In PNG and JPEG files, meta information is saved as EXIF information and can be read, for example, using the ExifTool.

12.4.1 Screenshot settings

Access: "Menu" > "Save/Recall" > "Save" tab > "Screenshot"

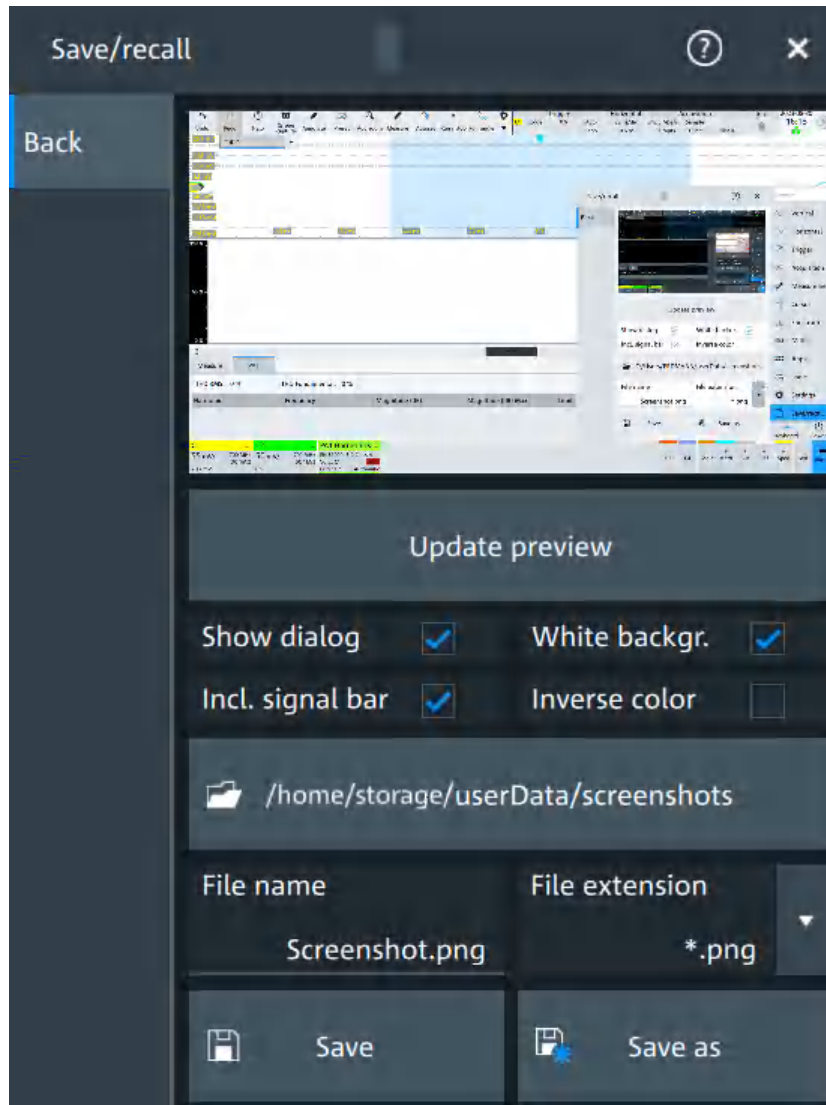

In the "Screenshot" dialog box, you configure the image to be saved or included in a report. You select the storage location for screenshot files. The image is created when you open the dialog box, and can be updated at any time.

You can also edit the colors of the image before saving it, and include an open dialog box or the sidebar in the image.

You can save the image in the dialog box. To save screenshots quickly, use the "Screen capture" toolbar icon, or configure and use the [Camera] key.

Preview	282
Update	282
Show setup dialog	282
White background	282

Include signal bar.....	282
Inverse color.....	282
Directory.....	282
File name, Extension.....	283
Save.....	283

Preview

Shows a preview of the screenshot. The image is created when the dialog box opens.

Update

Updates the preview of the screenshot with the current display view, e.g. after changes to the settings have been made, or an additional channel has been activated.

Show setup dialog

If enabled, the currently open dialog box is included in the screenshot.

Remote command:

[HCOPY:SSD](#) on page 557

White background

Inverts the background color, so you can picture waveforms with normal waveform colors on white background.

If both "White background" and "Inverse color" are enabled, the instrument inverts the background twice, and it appears black.

"White background"	"Inverse color"	Background	Waveform and results
On	Off	White	Screen colors
Off	On	White	Inverted colors
On	On	Black	Inverted colors
Off	Off	Black	Screen colors

Remote command:

[HCOPY:WBKG](#) on page 557

Include signal bar

If enabled, the screenshot shows the signal bar below the diagram area.

Remote command:

[HCOPY:ISBA](#) on page 556

Inverse color

Inverts the colors of the output, i.e. a dark waveform is shown on a white background.

Remote command:

[HCOPY:DEVICE<m>:INVerse](#) on page 555

Directory

Opens the file selection dialog box. Here you can adjust the target directory where the screenshot is saved. The symbols of important target folders are listed on the left of the file explorer.

Remote command:

[HCOPY:DESTination<m>](#) on page 555

File name, Extension

Sets a file name for the screenshot, and the extension of the file. You can save the screenshot as *.jpg or *.png file.

Save

Saves the current screenshot to the specified file.

12.4.2 Configuring and saving screenshots

You can select which elements are shown in the screenshot, invert the colors and the background color. A preview of the current image is shown for reference.

1. Open the "Menu" > "Save/Recall" > "Save" tab > "Screenshot".
2. To enhance the images for later print on white paper, enable "White background" or "Inverse color". If you print this image later on a monochrome printer, you get a grayscale picture. The contrast of the gray lines depends on waveform colors and the used printer.
3. To change the directory, tap "Browse" and configure the path.
The symbols of often used target folders are listed on the left of the file explorer. By default, screenshots are saved in the `/home/storage/userData/ScreenShots` directory.
4. Tap "Save".
The file is saved.
5. Check if the screenshot is saved to the desired directory.
6. To save further screenshots, use one of the following ways:
 - Configure the [Camera] key. Press the key to save a screenshot.
See also [Camera hardkey action](#).
 - Add the "Screen capture" icon to the toolbar. Tap the icon to save an image.
 - Tap "Save" in the "Screenshot" dialog box to save the image to the specified file.
 - To save the image with a dedicated filename or to another directory, tap "Browse" in the "Screenshot" dialog box.
Select the path, enter a filename, and tap "Save".

12.5 File browser dialog

The file browser dialog provides a file explorer from which you can select a file to load or to save data to. You can also manage your files in this dialog.

Access: [Apps] > "File browser".

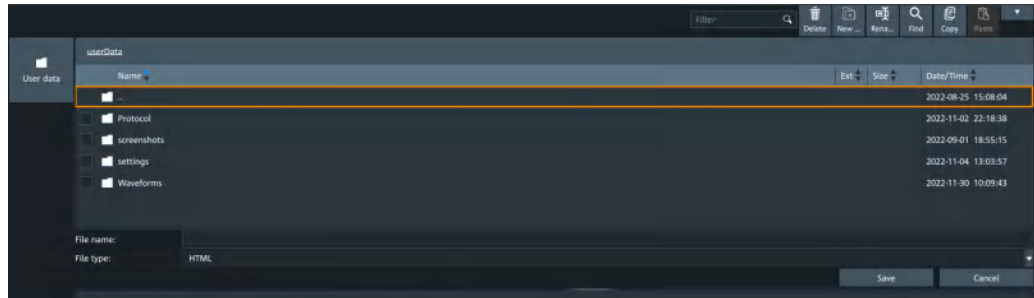

Path

Navigate the path elements to change the current folder. The default folder is defined in [Chapter 5.8.1, "Autonaming"](#), on page 95.

You can save the data in a local folder on the instrument.

On the left, shortcut icons provide access to often used folders.

Toolbar

The toolbar on the top provides various functions for file management.

"Filter"	Displays only the files and folders that match the current search term.
"Delete"	Deletes the selected file or folder.
"New folder"	Creates new folder in the current directory.
"Rename"	Renames the selected file.
"Find"	Searches for files within the current folder.
"Copy"	Copies the selected file.
"Paste"	Pastes the file.

File name

The file name to be loaded or stored to. Tap the file name, or tap the keyboard icon to enter the file name using the online keyboard.

The default file name for new files is defined in the "Autonaming" tab, see [Chapter 5.8.1, "Autonaming"](#), on page 95.

File type

The file extension of the file to be loaded or stored to.

Save, Select

Selects the specified file for the open or save operation and closes the dialog box.

Cancel

Closes the dialog box without selecting a file.

13 Protocol analysis

Using the serial protocol options for the R&S MXO 5, you can analyze various serial protocols.

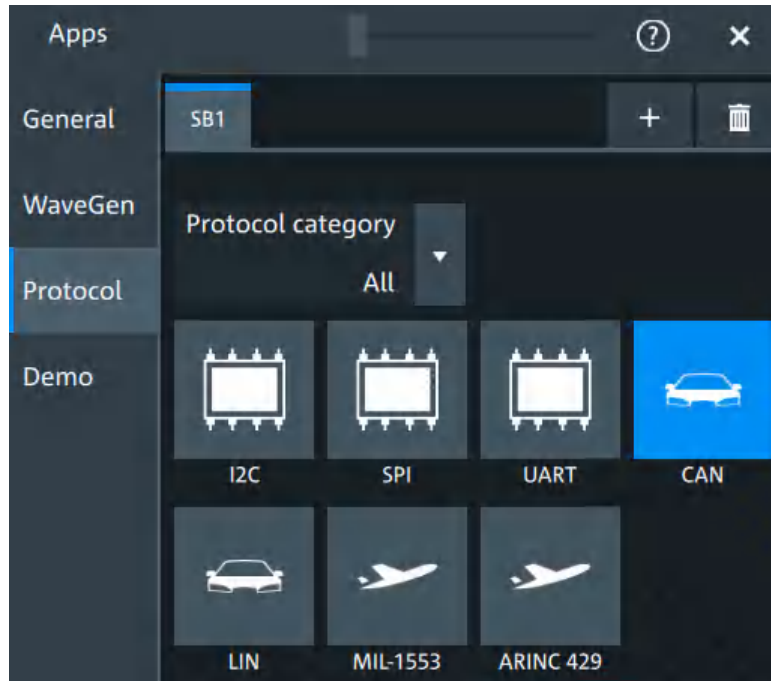

- [Basics of protocol analysis](#).....285
- [SPI bus \(option R&S MXO5-K510\)](#).....293
- [I²C \(option R&S MXO5-K510\)](#).....309
- [UART \(option R&S MXO5-K510\)](#).....326
- [CAN \(option R&S MXO5-K520\)](#).....340
- [LIN \(option R&S MXO5-K520\)](#).....365

13.1 Basics of protocol analysis

With the R&S MXO 5 oscilloscope, you can decode selected protocols.

With dual-path protocol analysis, you can set the instrument sample rate for the waveform path and the oscilloscope automatically uses another internal decoupled sample rate for the decoding path. Even with very slow sample rates, the protocol data is correctly decoded.

With the R&S MXO 5, you can use deep memory to capture more packets. The oscilloscope can capture long time periods where the cause and result are distanced in time. Over the entire capture, signal detail is time-correlated with packet content for fast debug.

Before you can analyze a serial signal, the bus has to be configured according to the protocol and specifics of the signal. The configuration contains:

- Assignment of the data and clock lines to the input channels
- Logical thresholds
- Protocol-specific settings

Serial data can be analyzed in several ways:

- **Triggering:** You can trigger on various events that are typical for the selected protocol type, for example, on start and stop of messages, or on specified data patterns in the message.
Triggering on a trigger event sequence is not supported, and holdoff settings are not available.
- **Protocol decoding:** The digitized signal data is displayed on the screen together with the decoded content of the messages in readable form, and the decode results are listed in a table.

13.1.1 Setup - general settings

For all protocols, configuration starts with the selection of the serial bus and the protocol.

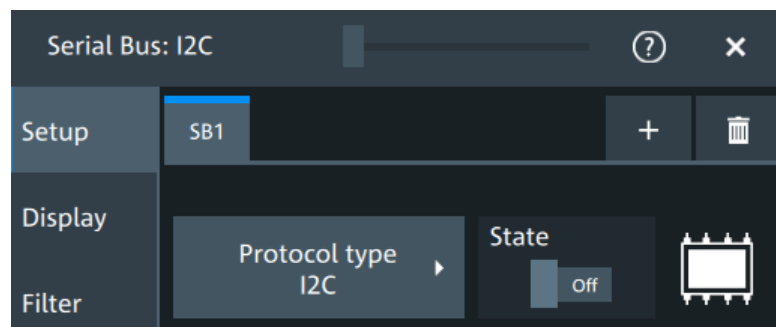

Configuration settings are protocol-specific. They are described in the related chapters.



Make sure that the tab of the correct serial bus is selected.

SB1 /SB2 /SB3 /SB4

Select the correct bus tab before you enter the settings.

Protocol type

Displays the protocol type to be decoded.

Remote command:

`SBUS<sb>:TYPE` on page 645

State

Enables the decoding of the selected bus. The signal icon of the bus appears on the signal bar.

Threshold

Press "Set thresholds", to open the "Threshold setup" dialog.

In the "Threshold setup" dialog, you can set values for threshold and hysteresis.

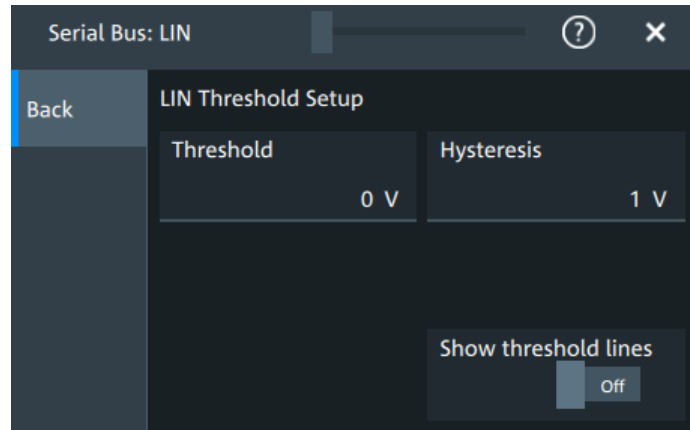

Show threshold lines ← Threshold

In the "Threshold" dialog, you can enable the display of the threshold lines in the diagram.

The label of the threshold line is set according to the signal that it is referring to. It is displayed in the color of the signal channel.

Example:

When the "Show threshold lines" is enabled, the threshold lines and the hysteresis are shown on the display for a few seconds. Afterwards only the threshold line is visible.



Figure 13-1: Threshold lines, shortly after Show threshold lines is enabled

Remote command:

`SBUS<m>: THReshold` on page 646

13.1.2 Advanced

Some protocols have additional more advanced settings. They are displayed in the "Advanced" tab.

The settings are protocol specific and are described in the corresponding protocol chapter.

13.1.3 Display

For all protocols, you can select to display the decoded signal as a table and to show the binary signal on the screen.

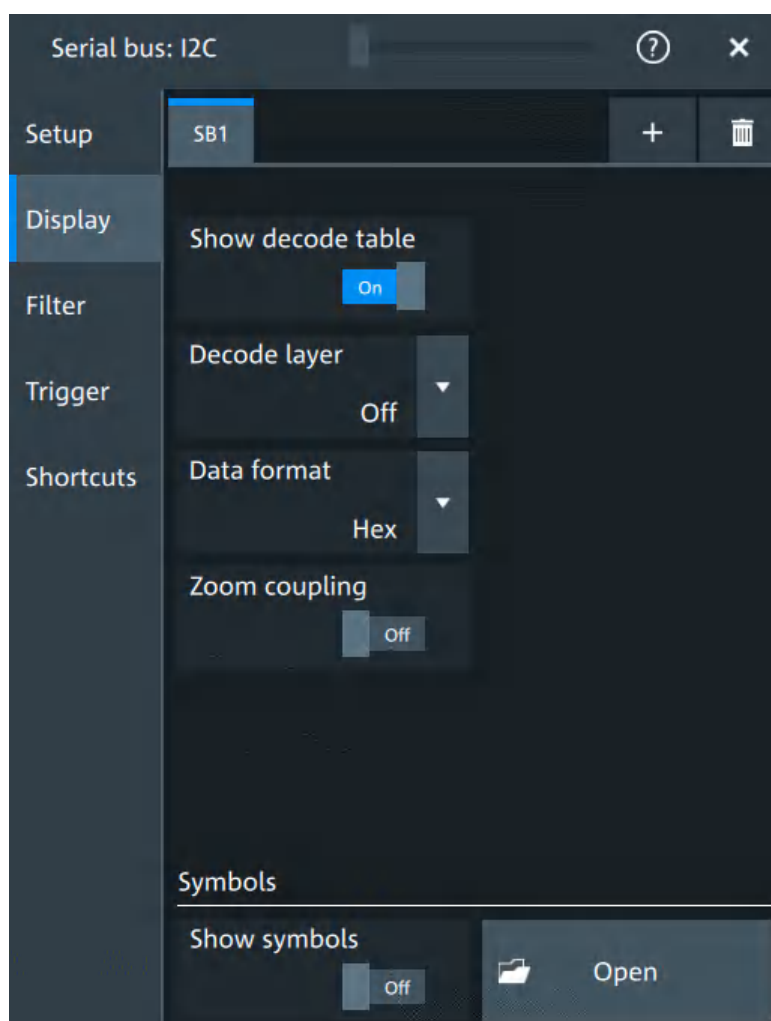

Show decode table

Opens a table with decoded data of the serial signal. The function requires the option for the analyzed protocol.

Decode results are protocol-specific.

Remote command:

[SBUS<sb>:RESult](#) on page 645

Decode layer

Selects the decode layer.

Decoding is performed in several steps, and the results are presented in the decode table. The decode layer selects an interim step for which the decoding result is shown in the honeycomb display.

The available values are protocol-specific.

"Off" No decode layer is displayed.

"Edges" All edges.

"Bits" All bits.

"Words" All words.

Data format

Sets the data format for the values displayed in the decode table and in the combs of the decoded signal.

Available formats are: hex, octal, binary, ASCii, signed, unsigned.

For more information on the available formats, see [Chapter 13.1.8, "Bit pattern editor"](#), on page 292.

Remote command:

[SBUS<sb>:FORMat](#) on page 645

Zoom coupling

If enabled, the decode zoom and result table are synchronized. If you select a row in the result table, this result is shown in the decode zoom.

Remote command:

[SBUS<m>:ZCOupling](#) on page 646

Symbols

Symbol lists are protocol-specific. They are described in the respective configuration chapter of the protocol.

13.1.4 Filter

In the "Filter" tab, you can define the settings to display only the frames that match the selected filter conditions.

The settings are protocol specific and are described in the corresponding protocol chapter.

13.1.5 Trigger

The "Trigger" tab gives quick access to the "Trigger" dialog.

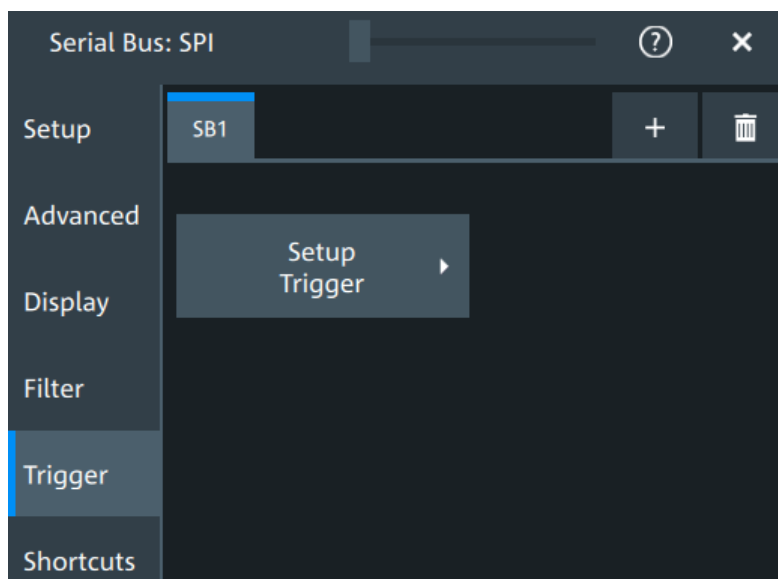

13.1.6 Shortcuts

The "Shortcuts" tab gives quick access to other dialogs with protocol relevant settings. The availability depends on the functions supported by the protocol.

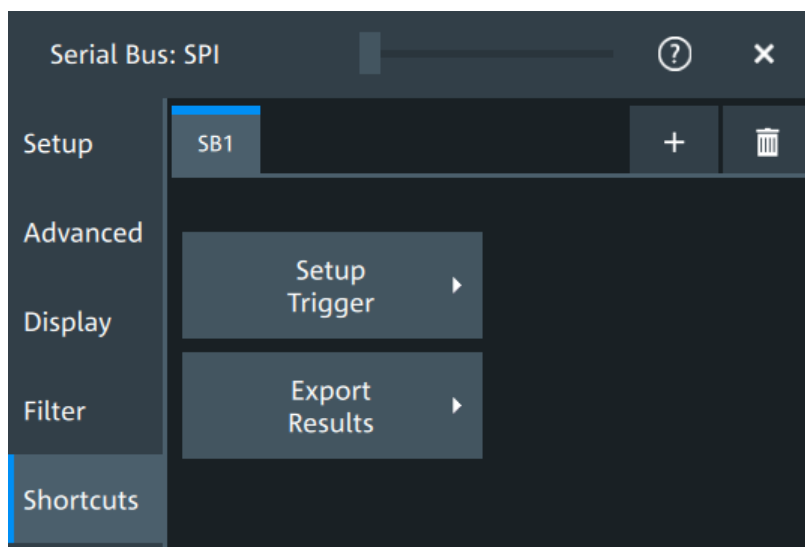

If you access a dialog from the "Shortcuts" tab, some settings are already predefined.

- "Setup trigger": you can trigger on various events that are typical for the selected protocol type, for example, on start and stop of messages, or on specified data patterns in the message.
- "Export results": in this dialog, you can select the decode results you want to export and the protocol-specific details to be included.

13.1.7 Export protocol results

In the "Export results" dialog, you can export the results and all details of the selected protocol.

The contents of the files are described in the

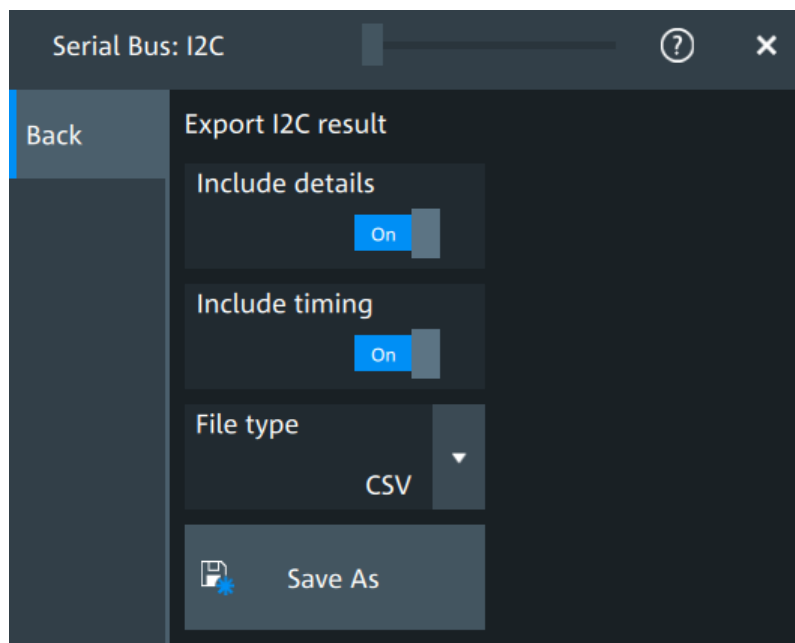

Include details

If enabled, includes the detailed results for all frames in the export result file.

Remote command:

[SBUS<sb>:EXPResult:DETail](#) on page 647

Include timing

If enabled, includes the frame timing in the export result file.

Remote command:

[SBUS<sb>:EXPResult:TIME](#) on page 647

File type

Selects the file format.

- | | |
|---------|--|
| ".csv" | The results are saved as a CSV compatible file. |
| ".html" | The results are saved as webpage for display in a browser. |
| ".xml" | The results are saved in an xml compatible file format. |
| ".py" | The values are saved in a Python compatible file format. |

Remote command:

[SBUS<sb>:EXPResult:EXTension](#) on page 648

Save as

Opens a dialog box where you can select a filename and a path for the export results file.

Remote command:

`SBUS<sb>:EXResult:SAVE` on page 647

`SBUS<sb>:EXResult:PATH` on page 648

13.1.8 Bit pattern editor

If you want to enter a specified address or data pattern, the pattern editor helps you to enter the pattern in various formats - decimal, hexadecimal, octal, binary and ASCII.

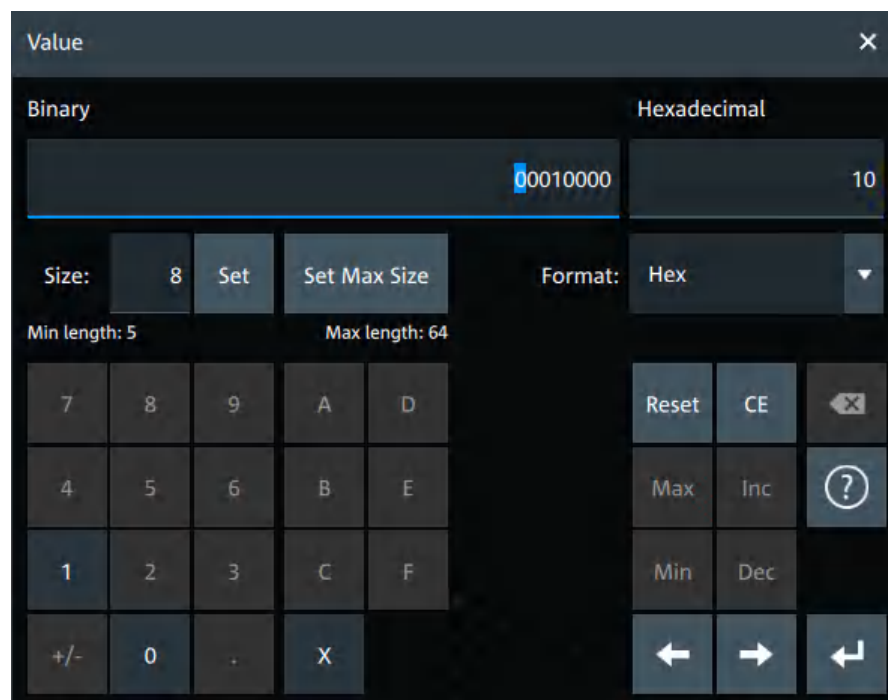

The editor at the top displays the pattern in two columns. The left column always shows binary data. For the right column, you can select the "Format". The default depends on the data specifics. You can edit data in the left or right column. The keypad adapts itself to the column format and only keys appropriate to the format are enabled.

The data is grouped and converted in bit groups. The size of a bit group depends on the address or data specifics and is set by the instrument. Groups are automatically separated by blanks. The maximum size of a bit group is 64 bit, the most common group size is 1 byte.

Format-specific information:

- Binary: 0, 1 and X (do not care) is allowed.
- Octal: Each digit represents 3 bit.
- Hex: most common format in the right column.

- ASCII: In the ASCII column, "X" is the character X. The binary X (do not care) is not allowed. If an X is included in the binary value in the left column, the ASCII column displays "§" to indicate that the value is not defined.
- Unsigned: Decimal data format without sign. 3 digits are grouped and next group is separated by comma, e.g. 653,848.
- Signed: Signed decimal format. 3 digits are grouped. The first bit represents the sign. You can use the 2's complement format. 3 digits are grouped and next group is separated by comma, e.g. -653,848.

13.2 SPI bus (option R&S MXO5-K510)

The Serial Peripheral Interface SPI is used for communication with slow peripheral devices, in particular, for transmission of data streams.

Required options and equipment

For performing SPI decode measurements, you need the following equipment:

- R&S MXO 5 with 4 channels. The channels can be a combination of the following:
 - Analog channels (C1-C4)
 - Logic channels (D0-D15) (requires option R&S MXO5-B1)
- Option R&S MXO5-K510

13.2.1 About the SPI protocol

A 4-channel instrument is required for full support of the SPI protocol, or the MSO option R&S MXO5-B1.

The Serial Peripheral Interface SPI is used for communication with slow peripheral devices, in particular, for transmission of data streams.

Main characteristics of SPI are:

- Main-subnode communication
- No device addressing. The sub is accessed by a chip select, or sub select line.
- No acknowledgment mechanism to confirm receipt of data
- Duplex capability

Most SPI buses have four lines, two data and two control lines:

- Clock line to all subs (SCLK)
- Sub select or Chip select line (SS or CS)
- Main data output, sub data input (MOSI or SDI)
- Main data input, sub data output (MISO or SDO)

When the main generates a clock and selects a sub device, data may be transferred in either or both directions simultaneously.

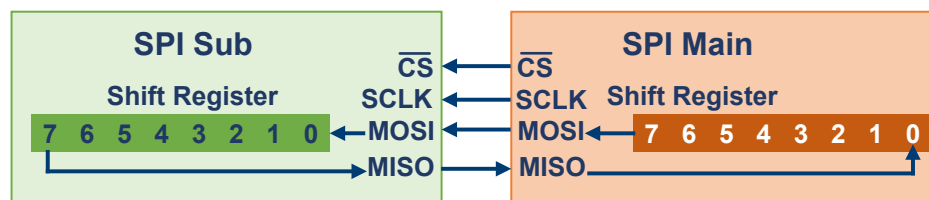

Figure 13-2: Simple configuration of SPI bus

The data bits of a message are grouped by following criteria:

- A word contains several successive bits. The word length is defined in the protocol configuration.
- A frame contains several successive words, at least one word.

13.2.2 SPI configuration

13.2.2.1 SPI configuration settings

Access: [Apps] key > "Protocol" tab > "SPI" > "Setup".



Make sure that the tab of the correct serial bus is selected.

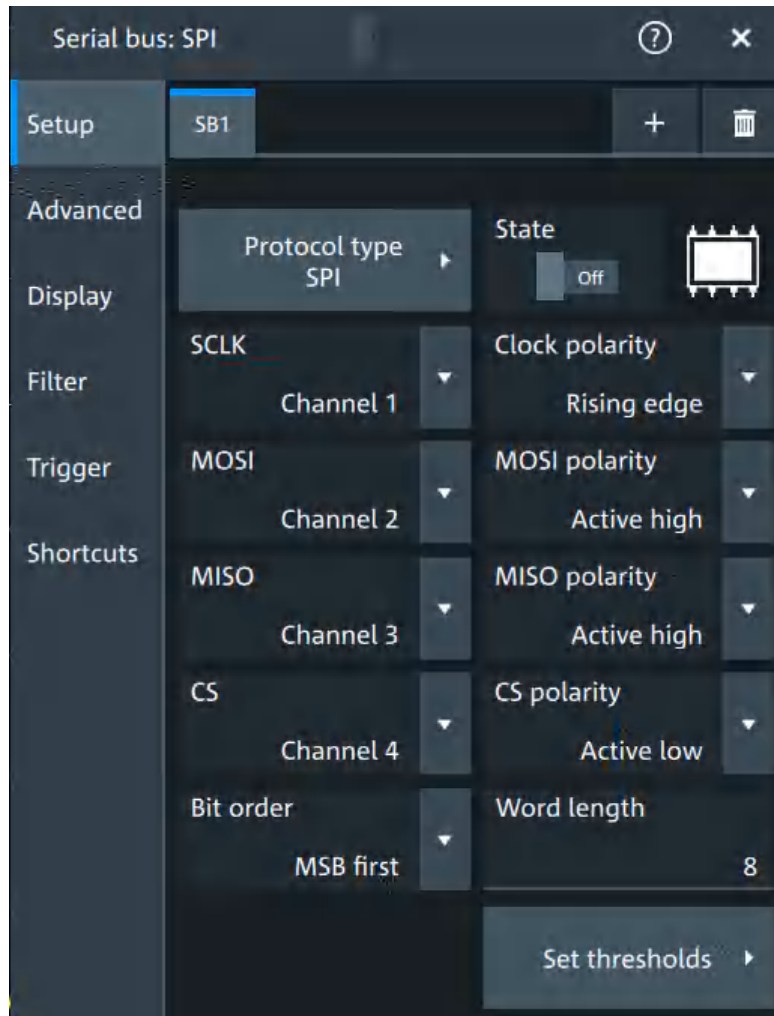

Protocol type

Displays the protocol type to be decoded.

Remote command:

[SBUS<sb>:TYPE](#) on page 645

State

Enables the decoding of the selected bus. The signal icon of the bus appears on the signal bar.

SCLK,MOSI,MISO,CS

Sets the input channel for the respective line:

- SCLK: clock line
- MOSI line
- MISO line
- CS: chip select

Alternatively, digital channels can be used if MSO option R&S MXO5-B1 is installed. Digital and analog channels cannot be used at the same time.

For triggering on a serial bus, analog or digital channel sources are required.

Remote command:

[SBUS<sb>:SPI:MISO:SOURce](#) on page 651

[SBUS<sb>:SPI:MOSI:SOURce](#) on page 652

[SBUS<sb>:SPI:SCLK:SOURce](#) on page 653

[SBUS<sb>:SPI:CSElect:SOURce](#) on page 650

Clock polarity

Two settings define the clock mode: the clock polarity and the clock phase. Together, they determine the edges of the clock signal on which the data are driven and sampled.

A master/slave pair must use the same parameter pair values to communicate. The clock phase defines the slope. It selects if data is stored with the rising or falling slope of the clock. The slope marks the begin of a new bit.

Polarity: MOSI, MISO, CS

Selects if the transmitted signal for the respective line is active high (high = 1) or active low (low = 1).

For triggering on a serial bus, analog or digital channel sources are required.

Remote command:

[SBUS<sb>:SPI:MISO:POLarity](#) on page 651

[SBUS<sb>:SPI:MOSI:POLarity](#) on page 652

[SBUS<sb>:SPI:CSElect:POLarity](#) on page 650

Bit order

Selects the bit order, which determines if the data of the messages starts with MSB (most significant bit) or LSB (least significant bit).

Remote command:

[SBUS<sb>:SPI:BORDER](#) on page 649

Word length

Sets the word length (or symbol size), which is the number of bits in a message. The maximum word length is 32 bit.

Remote command:

[SBUS<sb>:SPI:WSIZE](#) on page 654

Threshold

Press "Set thresholds", to open the "Threshold setup" dialog.

Enter the value directly in the field of the threshold setup dialog.

Additional to the threshold, you can also set a hysteresis.

If the signal value on the line is higher than the threshold, the signal state is high. Otherwise, the signal state is considered low if the signal value is below the threshold.

The interpretation of high and low is defined by the "[Polarity: MOSI, MISO, CS](#)" on page 296.

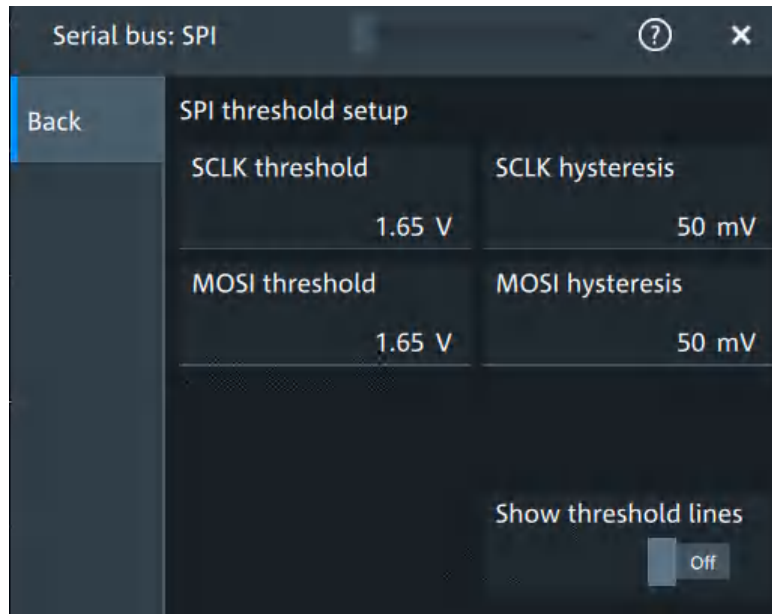

Remote command:

[SBUS<sb>:SPI:MISO:HYSTeresis](#) on page 651

[SBUS<sb>:SPI:MOSI:HYSTeresis](#) on page 652

[SBUS<sb>:SPI:SCLK:HYSTeresis](#) on page 653

[SBUS<sb>:SPI:CSElect:HYSTeresis](#) on page 650

[SBUS<sb>:SPI:MISO:THReshold](#) on page 652

[SBUS<sb>:SPI:MOSI:THReshold](#) on page 653

[SBUS<sb>:SPI:SCLK:THReshold](#) on page 654

[SBUS<sb>:SPI:CSElect:THReshold](#) on page 650

Show threshold lines ← Threshold

If enabled, the threshold lines are displayed in the diagram.

The label of the threshold line is set according to the signal that it is referring to.

Remote command:

[SBUS<m>:THReshold](#) on page 646

13.2.2.2 Advanced

Access: [Apps] key > "Protocol" tab > "SPI" > "Advanced".

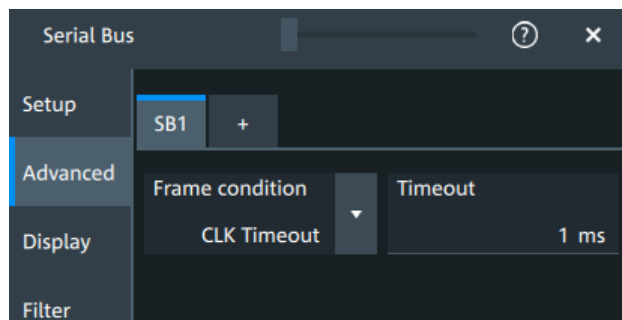

Frame condition

Defines the start of a frame. A frame contains a number of successive words, at least one word.

"CS" Start and end of the frame is defined by the active state of the sub select signal.

"CLK timeout" Defines a timeout on the clock line SCLK as limiter between two frames. The timeout condition is used for SPI connections without a CS line. Enter the minimum clock idle time in the field.

Remote command:

[SBUS<sb>:SPI:FRCondition](#) on page 649

Timeout

Sets the minimum clock idle time if a timeout on the clock line SCLK is used as limiter between two frames.

See also: "[Frame condition](#)" on page 298.

Remote command:

[SBUS<sb>:SPI:TIMEout](#) on page 654

13.2.2.3 Display settings

For details about the display settings, see [Chapter 13.1.3, "Display"](#), on page 288.

13.2.2.4 Shortcuts

For details about the available shortcuts, see [Chapter 13.1.6, "Shortcuts"](#), on page 290.

13.2.3 SPI filter

Access:[Apps] key > "Protocol" tab > "SPI" > "Filter" tab

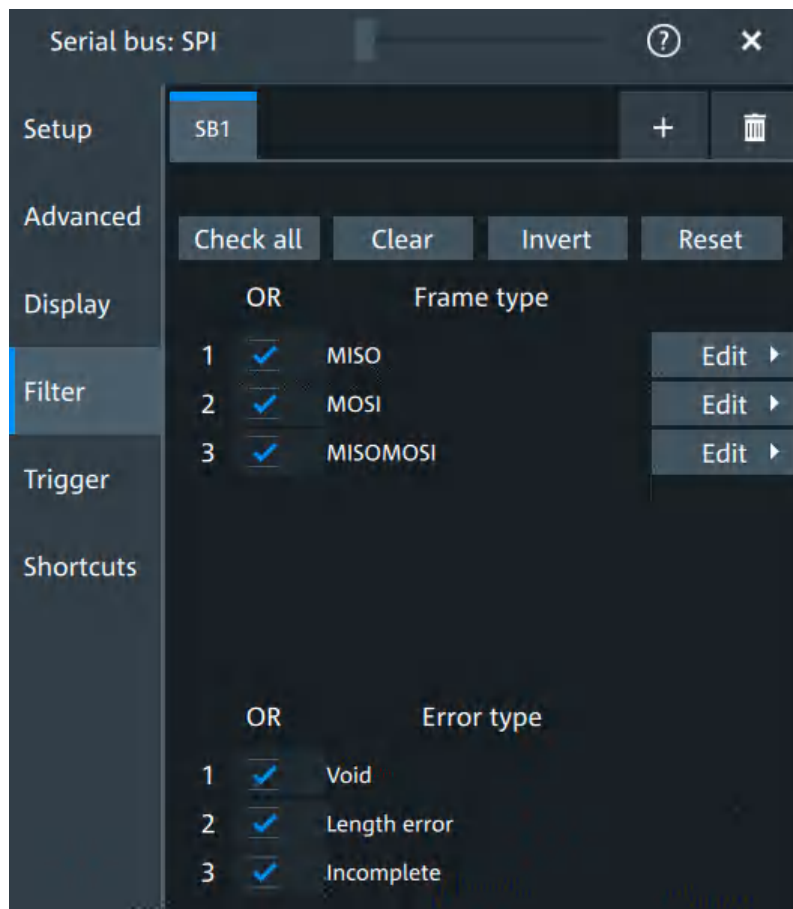

In the "Filter" tab, you can define the settings to display only the frames that match the selected filter conditions.

Check all, Clear, Invert, Reset

The following settings help you select the frames and errors you want to filter for. Only the frames and error types that match the selected filter conditions are displayed.

"Check all"	Enables the filter for all available frames and error types.
"Clear"	Disables the filter for all available frames and error types.
"Invert"	Inverts the current state of the frame and error types: all frames and error types that were enabled are disabled and vice versa.
"Reset"	Resets the state of the selected frames and error types.

Frame type

Selects the frame type that you want to display. You can filter all enabled frame types simultaneously.

For each frame type, you can also specify conditions for the value of the fields in the "Edit" dialog.

The available frames are "MOSI", "MISO" and "MOSI/MISO".

Remote command:

[SBUS<sb>:SPI:FILTer:FRAMe<fr>:ENABle](#) on page 658

[SBUS<sb>:SPI:FILTer:FRENable](#) on page 658

Edit

Opens a dialog to define the details of the selected frame.

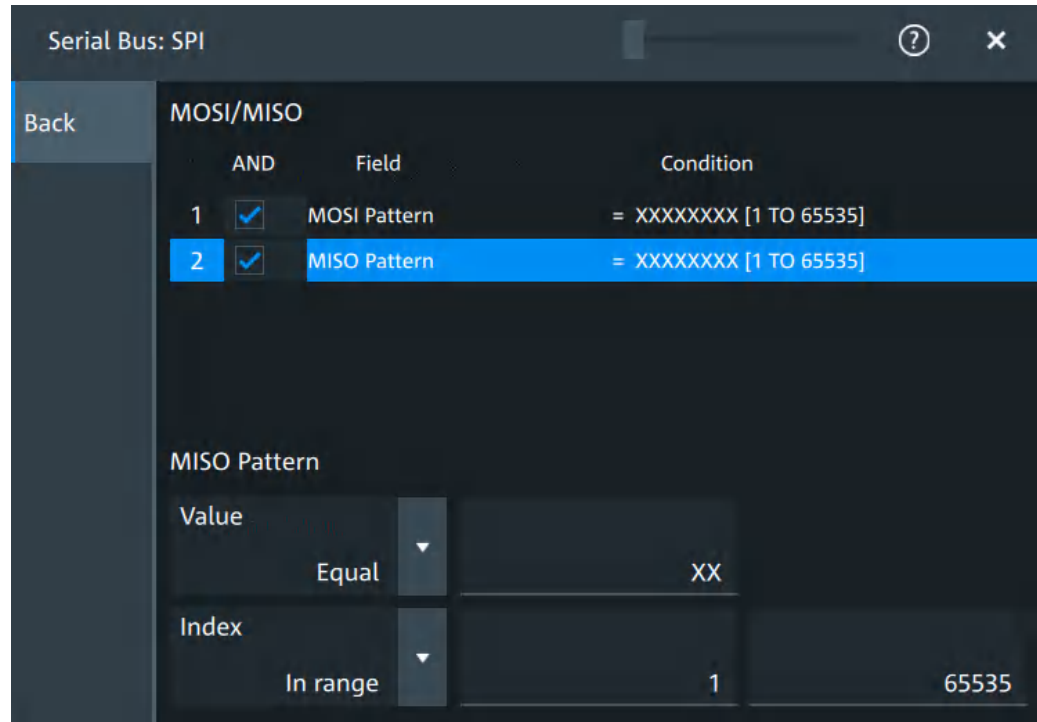

"Field" Enables the field type that you want to filter on for the selected frame. The available fields are "MOSI Pattern" and "MISO Pattern".

Remote command:

[SBUS<sb>:SPI:FILTer:FIENable](#) on page 658

[SBUS<sb>:SPI:FILTer:FRAMe<fr>:FLD<fl>:ENABle](#) on page 658

"Condition" Displays the value condition for the selected field.

Remote command:

[SBUS<sb>:SPI:FILTer:FRAMe<fr>:FLD<fl>:BIT](#) on page 656

"Data"	<p>The data setup consists of a comparison condition and one or two data patterns.</p> <p>Remote command:</p> <p>SBUS<sb>:SPI:FILTer:FRAMe<fr>:FLD<fl>:DMAX on page 656</p> <p>SBUS<sb>:SPI:FILTer:DMAX on page 656</p> <p>SBUS<sb>:SPI:FILTer:FRAMe<fr>:FLD<fl>:DMIN on page 657</p> <p>SBUS<sb>:SPI:FILTer:DMIN on page 657</p> <p>SBUS<sb>:SPI:FILTer:FRAMe<fr>:FLD<fl>:DOPerator on page 657</p> <p>SBUS<sb>:SPI:FILTer:DOPerator on page 657</p>
"Index"	<p>The index setup consists of a comparison condition and one or two index values.</p> <p>Remote command:</p> <p>SBUS<sb>:SPI:FILTer:FRAMe<fr>:FLD<fl>:IMAX on page 658</p> <p>SBUS<sb>:SPI:FILTer:IMAX on page 658</p> <p>SBUS<sb>:SPI:FILTer:FRAMe<fr>:FLD<fl>:IMIN on page 659</p> <p>SBUS<sb>:SPI:FILTer:IMIN on page 659</p> <p>SBUS<sb>:SPI:FILTer:FRAMe<fr>:FLD<fl>:IOPerator on page 659</p> <p>SBUS<sb>:SPI:FILTer:IOPerator on page 659</p>

Edit

Opens a dialog to define the details of the selected frame.

Error type

Enables filtering on the selected error type.

Available error types are "Void", "Length error" and "Incomplete".

Remote command:

[SBUS<sb>:SPI:FILTer:ERRor<n>:ENABle](#) on page 657

13.2.4 SPI trigger

Access: [Apps] key > "Protocol" tab > "SPI" > "Shortcuts".

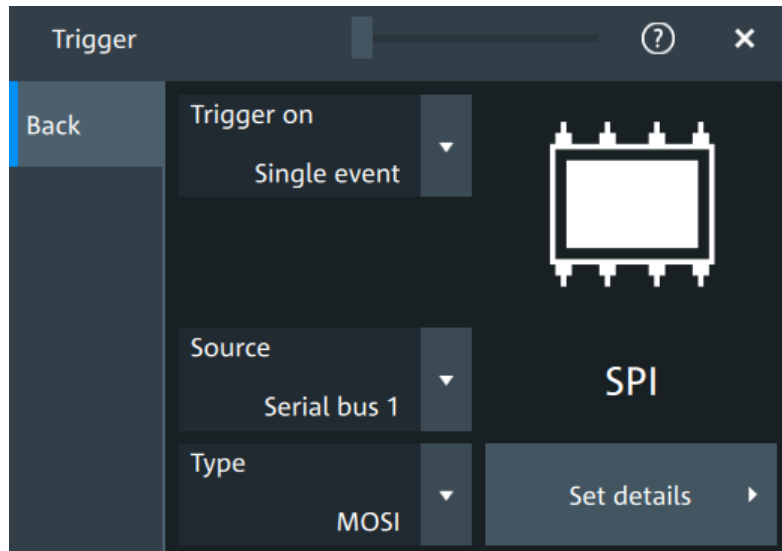

Type

Selects the trigger type for SPI analysis.

Some trigger types have additional settings that can be defined. In this case, the "Set details" button appears next to "Type" the function. Open it for a detailed definition of the trigger conditions.

"Start of frame" Sets the trigger to the beginning of the frame.

"End of frame" Sets the trigger to the end of the frame.

"MOSI" Sets the trigger to a specified data pattern expected on the MOSI line.
Available, if there is a channel assigned to the "MOSI" line in the "Setup" tab.

"MISO" Sets the trigger to a specified data pattern expected on the MISO line.
Available, if there is a channel assigned to the "MISO" line in the "Setup" tab.

Remote command:

[TRIGger:SPI:TYPE](#) on page 660

Data conditions

The trigger on MOSI and MISO patterns is defined in the same way:

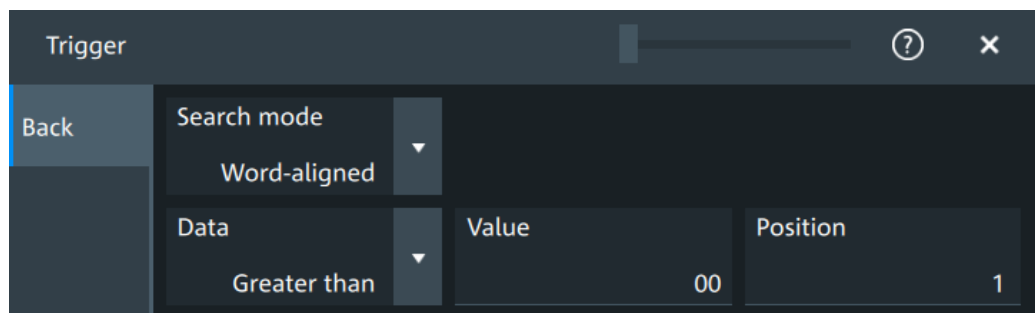

Search mode ← Data conditions

Defines how the specified data pattern is searched.

"Bit-aligned" Bit-by-bit: the pattern can start at any position in the message.

"Word-aligned" The pattern is matched only at word boundaries.

Remote command:

[TRIGger:SPI:PALignment](#) on page 661

Data ← Data conditions

Selects the operator condition for the data pattern and sets the data pattern.

Remote command:

[TRIGger:SPI:FCONdition](#) on page 661

[TRIGger:SPI:DMINpattern](#) on page 660

Position ← Data conditions

Sets the number of bits or words to be ignored before the first bit or word of interest.

Remote command:

[TRIGger:SPI:DPOSition](#) on page 660

13.2.5 SPI decode results

When the configuration of the serial bus is complete, the signal can be decoded:

1. Open the "Serial Bus" dialog for the respective bus.
2. In the "Setup" tab, enable "State".
3. In the "Display" tab, enable "Show decode table".

For a description of the display settings, see also [Chapter 13.1.3, "Display"](#), on page 288.

The instrument captures and decodes the signal according to the standard definition and the configuration settings.

The color-coding of the various protocol sections and errors simplifies the interpretation of the visual display. The decode information condenses or expands, depending on the horizontal scale. Various data formats are available to show the result values.

Decode results table

The "Decode results" table contains information about all decoded frames.



Figure 13-3: Decoded and binary SPI signal

Green brackets [...] = Start and end of complete frame
 Red brackets [...] = Start and end of incomplete frame
 Yellow = Word
 Red = Error

Table 13-1: Content of the "Decode results" table

Column	Description
Index	Index of the decoded frame
State	Overall state of the frame
Start	Times of frame start
Count	Number of words in the frame
MOSI values	Value of the MOSI data words. The data format is selected in the "Display" tab.
MISO values	Value of the MISO data words. The data format is selected in the "Display" tab.
Bit rate	Value of the bit rate

Data format

You can select various data formats for the values displayed in the decode table and in the combs of the decoded signal.

Remote command:

- `SBUS<sb>:FORMat` on page 645

Export of decode results

1. In the protocol "Shortcuts" tab, press "Export results".

The "Export results" dialog opens.

For details, see [Chapter 13.1.7, "Export protocol results"](#), on page 291.

2. Select the details that you want to export and the file format.
3. Tap "Save as".
4. Key in a name and select the file format.

Remote commands

Remote commands to retrieve decode results are described in [Chapter 17.16.2.4, "Decode results"](#), on page 661.

13.2.6 Performing SPI decoding

This chapter explains step by step how to configure and decode the SPI bus.

For more information on decoding SPI, you can also refer to the video, available on the Rohde & Schwarz YouTube channel: [Decoding SPI with MXO Series Oscilloscope](#).

13.2.6.1 Configuring SPI signals

For configuration, assign the lines to the input channels, and define the active states and the logical thresholds.

For details on configuration settings, see [Chapter 13.2.2, "SPI configuration"](#), on page 294.

1. Tap the "Bus" activator in the bottom right of the screen.

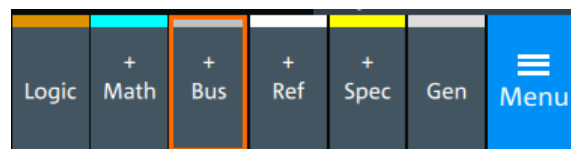

2. Select the tab of the bus that you want to set up, for example "SB1".
3. Tap the "Protocol type" button. Select the protocol: "SPI".
4. Tap on "State" to enable the decoding.

An SPI shortcut appears at the bottom left of the screen. Tap on the shortcut for a quick access to the "SPI" dialog settings.

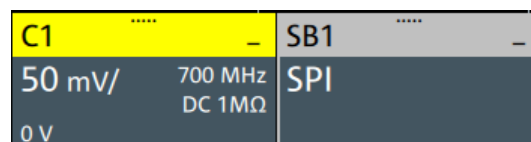

5. Tap on each active wire and select the correct channels: "SCLK", "MOSI", "MISO", "CS".
6. Set "Bit order" to "MSB" or "LSB first".
7. Set "Clock polarity" to "Rising edge" (CPOL = 0) or "Falling edge" (CPOL = 1).

8. Set "MOSI polarity"/"MISO polarity" to "Active high"(CPHA = 0) or "Active low"(CPHA = 1).
9. Set "CS polarity" to "Active high" or "Active low".
The typical value is "Active low", which means that the line is pulled low on message start.
10. Set the "Word length". The typical value is 8.
11. Check that the signals are on the screen.
If not try adjusting the vertical and horizontal settings.



12. Set the logical thresholds:
 - a) Tap "Threshold setup". The threshold dialog opens.
 - b) For each wire, set the threshold value. A typical value is 1.65 V.
 - c) If necessary, set the hysteresis value for the wires.
 - d) Optionally, tap on "Show threshold lines".

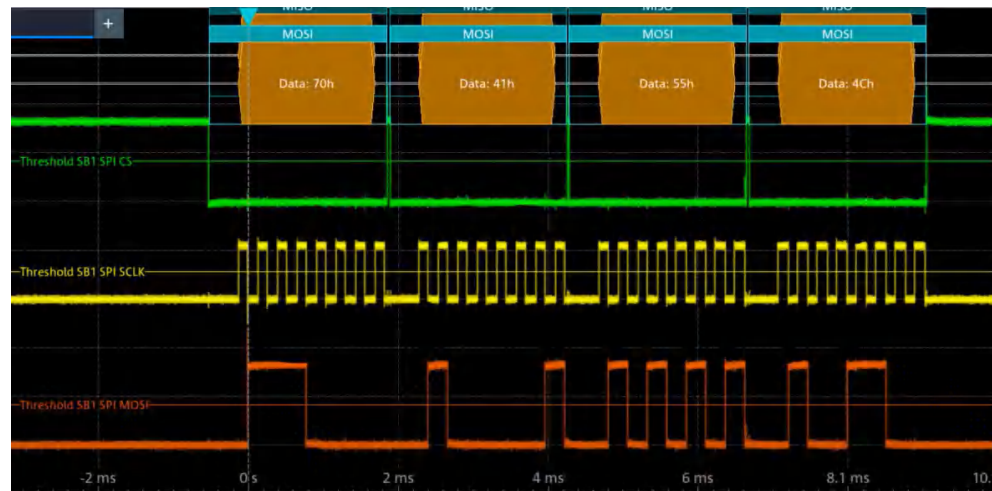

13.2.6.2 Triggering on SPI

Prerequisites: A bus is configured for the SPI signal to be analyzed. See [Chapter 13.2.6.1, "Configuring SPI signals"](#), on page 305.

For details on configuration settings, see [Chapter 13.2.2, "SPI configuration"](#), on page 294.

1. Open "Menu" > "Trigger".
2. Set "Trigger on" to "Single event".
3. Ensure that the "Source" is set to the configured serial bus, e.g. "Serial bus 1".
4. Select the "Type".
5. Define additional settings for more complex trigger types ("MOSI"/ "MISO"):
 - a) Tap on "Set details".
 - b) Set the "Search mode".
 - c) Set the "Data pattern" or a data range.

In the following example a decode for triggering on "MOSI" triggered on "Data pattern" = 0x41.



Figure 13-4: Trigger on Type= MOSI, Data pattern = 41

13.2.6.3 Exporting decode results

Once a decode has been completed, you can export the decode results of the

Prerequisites: A bus is configured for the SPI and decoded.

1. Tap on the "SPI" shortcut.
2. Tap on the "Shortcuts" tab.
3. Tap "Export results".
4. If necessary, enable "Include details".
5. If necessary, enable "Include timing".
6. Select the "File type".

An export file is saved in the selected directory.

The SPI export file contains the following fields:

- A list of all decoded frames:
 - Index
 - Start
 - Stop
 - Source
 - State
 - Bit rate
- The details frame includes the following fields:
 - Index
 - Start time
 - Stop time
 - MOSI values
 - MISO values

Example SPI export file

```
Index,Start,Stop,State,Count,BitRate
1,-2.9e-05,-2.872e-05,'OK',2,50000000
2,-2.844e-05,-2.83e-05,'OK',1,50000000
3,-2.816e-05,-2.788e-05,'OK',2,50000000
4,-2.76e-05,-2.746e-05,'VOID',0,---
```

Details frame 1

```
Index,Start Time,Stop Time,MOSI Values,MISO Values
1,-2.9e-05,-2.886e-05,AFh,---
2,-2.886e-05,-2.872e-05,FEh,---
```

Details frame 2

```
Index,Start Time,Stop Time,MOSI Values,MISO Values
1,-2.844e-05,-2.83e-05,---,34h
```

Details frame 3

```
Index,Start Time,Stop Time,MOSI Values,MISO Values
```

```
1, -2.816e-05, -2.802e-05, CAh, F0h
2, -2.802e-05, -2.788e-05, 05h, 0Dh
```

13.3 I²C (option R&S MXO5-K510)

The Inter-Integrated Circuit is a simple, low-bandwidth, low-speed protocol used for communication between on-board devices, for example, in LCD and LED drivers, RAM, EEPROM, and others.

Required options and equipment

For performing I²C decode measurements, you need the following equipment:

- R&S MXO 5 with 2 available channels. The channels can be a combination of the following:
 - Analog channels (C1-C4)
 - Logic channels (D0-D15) (requires option R&S MXO5-B1)

- Option R&S MXO5-K510

• About the I²C protocol	309
• I²C configuration	311
• I²C filter	314
• I²C trigger settings	316
• I²C decode results	320
• Performing I²C decoding	322

13.3.1 About the I²C protocol

This chapter provides an overview of protocol characteristics, data format, address types and trigger possibilities. For detailed information, read the "I²C-bus specification and user manual" available on the NXP manuals webpage at <http://www.nxp.com/>.

I²C characteristics

Main characteristics of I²C are:

- Two-wire design: serial clock (SCL) and serial data (SDA) lines
- Controller/ target communication: the controller generates the clock and addresses the targets. Targets receive the address and the clock. Both controller and targets can transmit and receive data.
- Addressing scheme: each target device is addressable by a unique address. Multiple target devices can be linked together and can be addressed by the same controller.
- Read/write bit: specifies if the controller reads (=1) or writes (=0) the data.
- Acknowledge: takes place after every byte. The receiver of the address or data sends the acknowledge bit to the transmitter.

The R&S MXO 5 supports all operating speed modes: high-speed, fast mode plus, fast mode, and standard mode.

Data transfer

The format of a simple I²C message (frame) with 7-bit addressing consists of the following parts:

- Start condition: a falling slope on SDA while SCL is high
- 7-bit address of the target device that either is written to or read from
- R/W bit: specifies if the data is written to or read from the target
- ACKnowledge bits: is issued by the receiver of the previous byte if the transfer was successful
Exception: At read access, the controller terminates the data transmission with a NACK bit after the last byte.
- Data: several data bytes with an ACK bit after every byte
- Stop condition: a rising slope on SDA while SCL is high

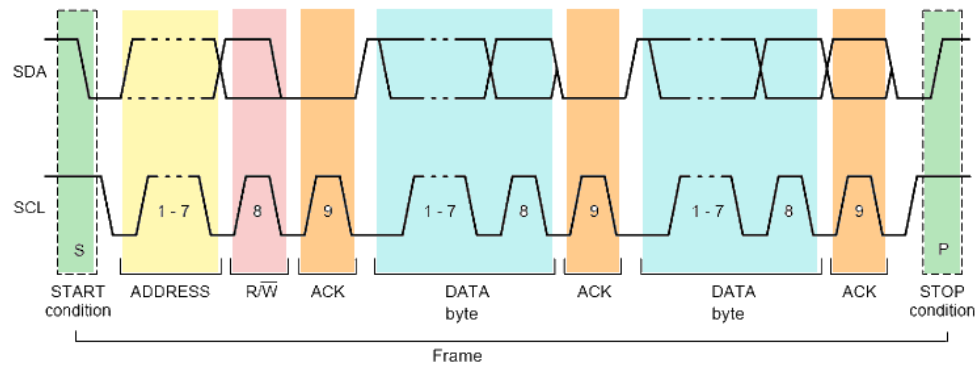

Figure 13-5: I2C writes access with 7-bit address

Address types: 7-bit and 10-bit

Target addresses can be 7 bits or 10 bits long. A 7-bit address requires 1 byte, 7 bits for the address followed by the R/W bit.

A 10-bit address for write access requires 2 bytes: the first byte starts with the reserved sequence 11110, followed by the two MSB of the address and the write bit. The second byte contains the remaining 8 LSB of the address. The target acknowledges each address byte.

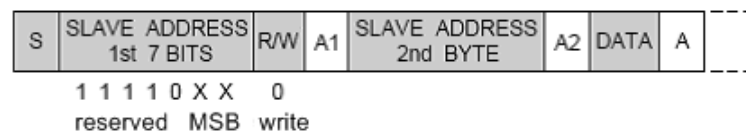

Figure 13-6: 10-bit address, write access

A 10-bit address for read access requires 3 bytes. The first 2 bytes are identical to the write access address. The third byte repeats the address bits of the first byte and sets the read bit.

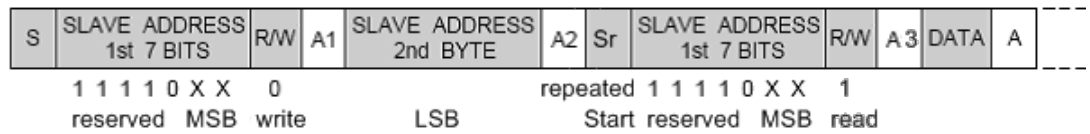

Figure 13-7: 10-bit address, read access

Trigger

The R&S MXO 5 can trigger on various parts of I²C messages. The data and clock lines must be connected to the input channels, triggering on math and reference waveforms is not possible.

You can trigger on:

- Start or stop condition
- Repeated start condition
- Transfer direction (read or write)
- Bytes with missing acknowledge bit
- Specific data pattern in the message

13.3.2 I²C configuration

13.3.2.1 I²C configuration settings

Access: [Apps] key > "Protocol" tab > "I²C" > "Setup".

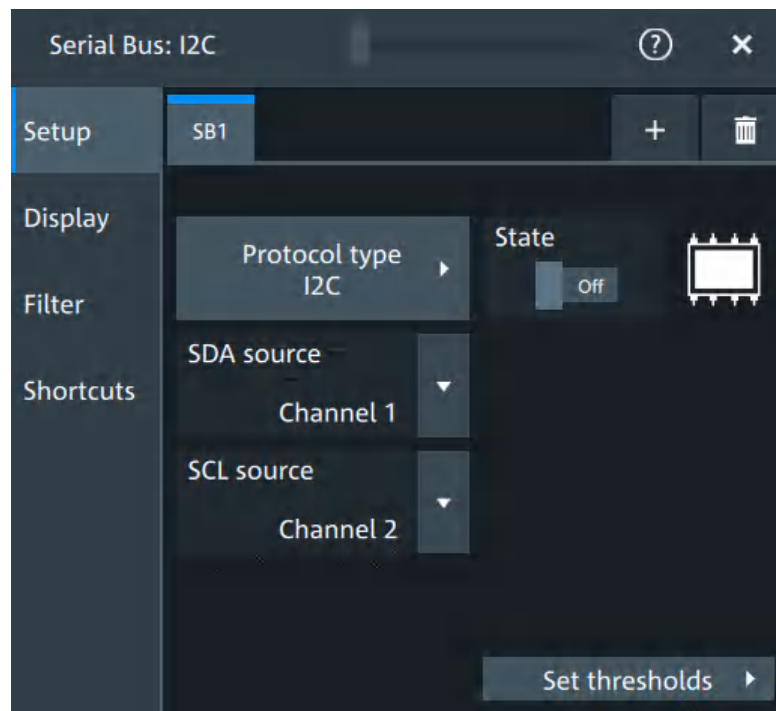



Make sure that the tab of the correct serial bus is selected.

Protocol type

Displays the protocol type to be decoded.

Remote command:

[SBUS<sb>:TYPE](#) on page 645

State

Enables the decoding of the selected bus. The signal icon of the bus appears on the signal bar.

SDA source

Sets the source channel to which the data line is connected.

Remote command:

[SBUS<sb>:I2C:SDA:SOURce](#) on page 668

SCL source

Selects the source channel to which the clock line is connected.

Remote command:

[SBUS<sb>:I2C:SCL:SOURce](#) on page 667

Threshold

Press "Set thresholds", to open the "Threshold setup" dialog.

Enter the value directly in the field of the threshold setup dialog.

Additional to the threshold, you can also set a hysteresis.

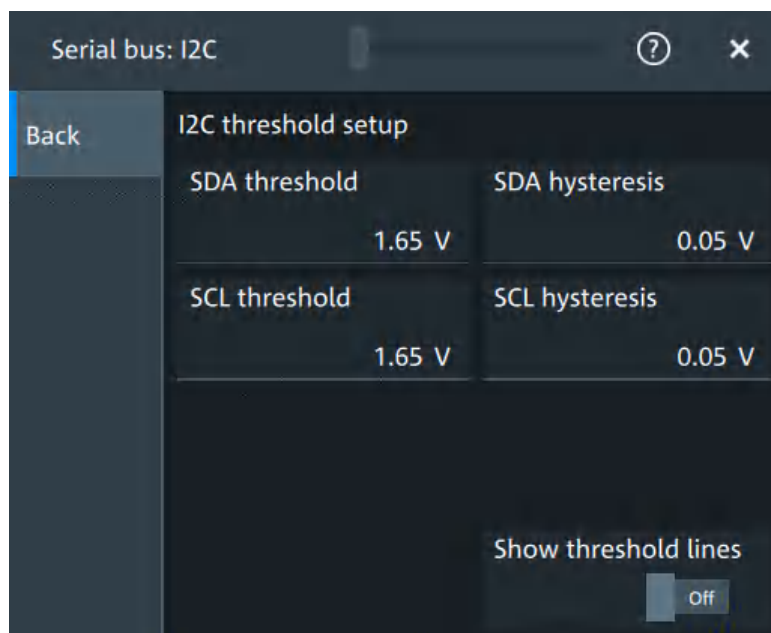

Remote command:

`SBUS<sb>:I2C:SCL:THReshold` on page 667

`SBUS<sb>:I2C:SDA:THReshold` on page 668

`SBUS<sb>:I2C:SCL:HYSTeresis` on page 667

`SBUS<sb>:I2C:SDA:HYSTeresis` on page 668

Show threshold lines ← Threshold

If enabled, the threshold lines are displayed in the diagram.

The label of the threshold line is set according to the signal that it is referring to.

Remote command:

`SBUS<m>:THReshold` on page 646

13.3.2.2 Display settings

For details about the display settings, see [Chapter 13.1.3, "Display"](#), on page 288.

Show symbols

Symbol lists are protocol-specific. Label lists for I²C are available in CSV format.

Remote command:

`SBUS<sb>:I2C:SYMBols` on page 669

`SBUS<sb>:I2C:NEWLlist` on page 669

13.3.2.3 I²C symbols

For the I²C protocol, you can upload symbol lists containing IDs and a symbolic name for each node. You can load a file in one of the supported formats:

Label lists are protocol-specific. Label lists for I²C are available in CSV format.

An I²C label file contains three values for each address:

- Address type, 7-bit or 10-bit long
- Address value
- Symbolic label: name of the address, specifying its function in the bus network.

Example: I²C CSV file

```
# -----
@FILE_VERSION = 1.00
@PROTOCOL_NAME = i2c
# -----
# Labels for I2C protocol
# Column order: Identifier type, Identifier value, Label
# -----
7,0x1E,Voltage
7,38h,Pressure
7,2Ah,Temperature
7,16h,Speed
7,118,Acceleration
7,07h,HighSpeed_Master_0x3
```

```

7, 51h, EEPROM
10, 3A2h, DeviceSetup
10, 1A3h, GatewayStatus
10, 06Eh, LeftSensor
# -----

```

13.3.2.4 Shortcuts

For details about the available shortcuts, see [Chapter 13.1.6, "Shortcuts"](#), on page 290.

13.3.3 I²C filter

Access: [Apps] key > "Protocol" tab > "I²C" > "Filter" tab

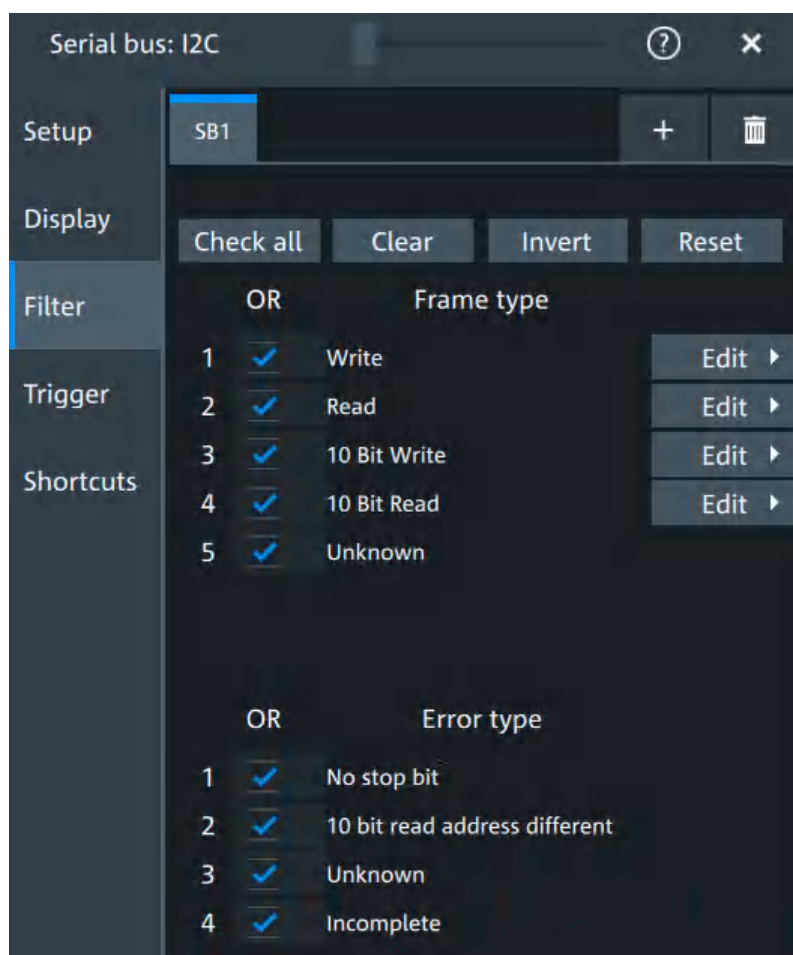

In the "Filter" tab, you can define the settings to display only the frames that match the selected filter conditions.

Check all, Clear, Invert, Reset

The following settings help you select the frames and errors you want to filter for. Only the frames and error types that match the selected filter conditions are displayed.

"Check all"	Enables the filter for all available frames and error types.
"Clear"	Disables the filter for all available frames and error types.
"Invert"	Inverts the current state of the frame and error types: all frames and error types that were enabled are disabled and vice versa.
"Reset"	Resets the state of the selected frames and error types.

Frame type

Selects the frame type that you want to display. You can filter all enabled frame types simultaneously.

For each frame type, you can also specify conditions for the value of the fields in the "Edit" dialog.

Remote command:

[SBUS<sb>:I2C:FILTer:FRENable](#) on page 674

[SBUS<sb>:I2C:FILTer:FRAME<fr>:ENABLE](#) on page 674

Edit

Opens a dialog to define the details of the selected frame.

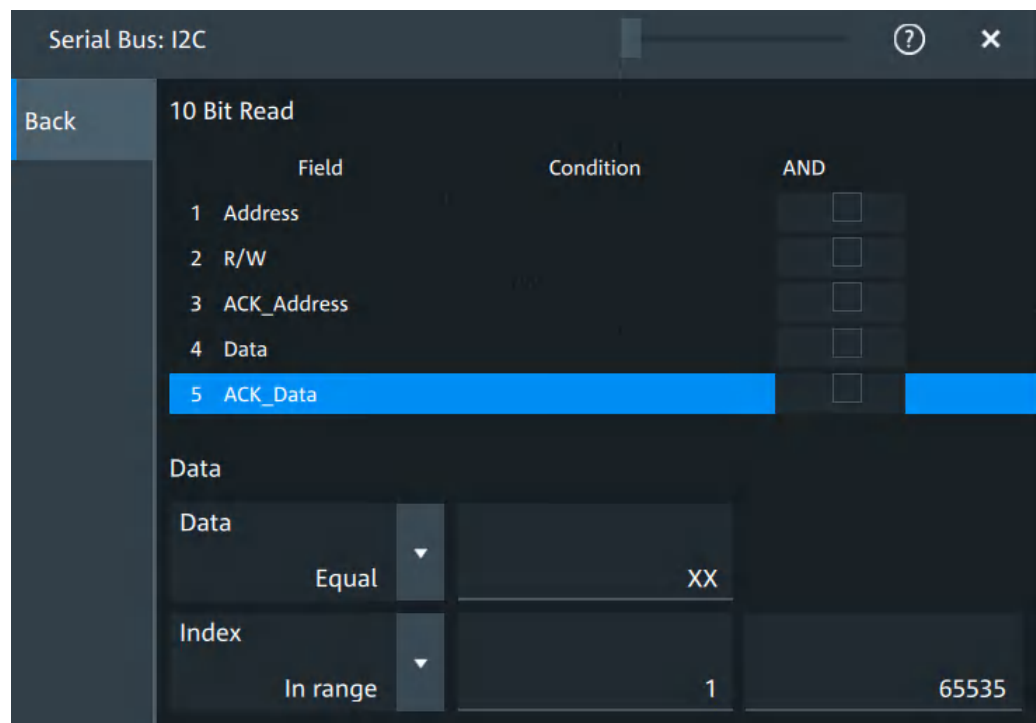

"Field"	<p>Enables the field type that you want to filter on for the selected frame. The available fields are "Address", "R/W", "ACK_A", "Data", and "ACK_D".</p> <p>Remote command: SBUS<sb>:I2C:FILTer:FRAMe<fr>:FLD<fl>:ENABle on page 677 SBUS<sb>:I2C:FILTer:FIENable on page 677</p>
"Condition"	<p>Displays the value condition for the selected field.</p> <p>Remote command: SBUS<sb>:I2C:FILTer:FRAMe<fr>:FLD<fl>:BIT on page 677</p>
"Data"	<p>The data setup consists of a comparison condition and one or two data patterns.</p> <p>Remote command: SBUS<sb>:I2C:FILTer:FRAMe<fr>:FLD<fl>:DMAX on page 674 SBUS<sb>:I2C:FILTer:DMAX on page 674 SBUS<sb>:I2C:FILTer:FRAMe<fr>:FLD<fl>:DMIN on page 675 SBUS<sb>:I2C:FILTer:DMIN on page 675 SBUS<sb>:I2C:FILTer:FRAMe<fr>:FLD<fl>:DOPerator on page 675 SBUS<sb>:I2C:FILTer:DOPerator on page 675</p>
"Index"	<p>The index setup consists of a comparison condition and one or two index values.</p> <p>Remote command: SBUS<sb>:I2C:FILTer:FRAMe<fr>:FLD<fl>:IMAX on page 676 SBUS<sb>:I2C:FILTer:IMAX on page 676 SBUS<sb>:I2C:FILTer:FRAMe<fr>:FLD<fl>:IMIN on page 676 SBUS<sb>:I2C:FILTer:IMIN on page 676 SBUS<sb>:I2C:FILTer:FRAMe<fr>:FLD<fl>:IOPerator on page 676 SBUS<sb>:I2C:FILTer:IOPerator on page 676</p>

Error type

Enables filtering on the selected error type.

Remote command:

[SBUS<sb>:I2C:FILTer:ERENable](#) on page 675

[SBUS<sb>:I2C:FILTer:ERRor<n>:ENABle](#) on page 675

13.3.4 I²C trigger settings

Access: [Apps] > "Protocol" > "I²C" > "Shortcuts" > "Setup trigger"

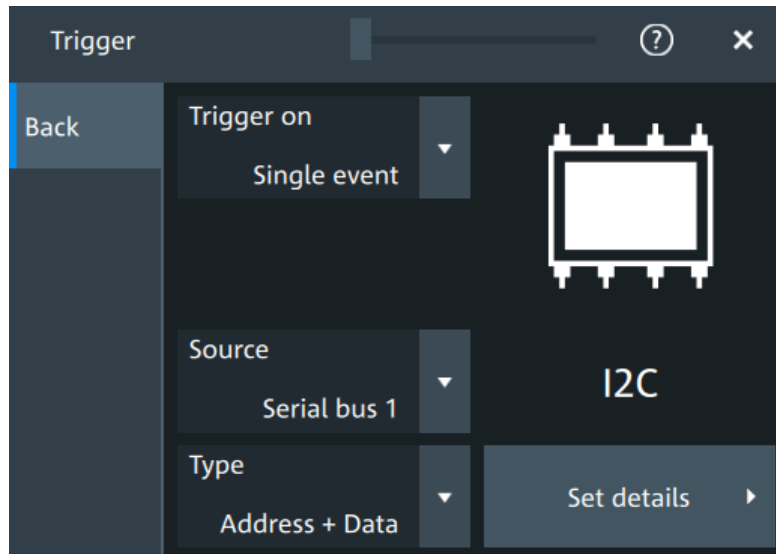
**Type**

Selects the trigger type for I²C analysis.

Some trigger types have additional settings that can be defined. In this case, the "Set details" button appears next to "Type" the function. Open it for a detailed definition of the trigger conditions.

Remote command:

`TRIGger:I2C:TYPE` on page 670

Start ← Type

Sets the trigger to the start of the message. The start condition is a falling edge on SDA while SCL is high. The trigger instant is the falling edge of the SDA line.

You can change the SDA and SCL lines here if necessary.

Repeated start ← Type

Sets the trigger to a repeated start - when the start condition occurs without previous stop condition. Repeated start conditions occur when a controller exchanges multiple messages with a target device without releasing the bus.

Stop ← Type

Sets the trigger to the end of the message. The stop condition is a rising slope on SDA while SCL is high.

No Ack ← Type

Missing acknowledge bit: the instrument triggers if the data line remains HIGH during the clock pulse following a transmitted byte.

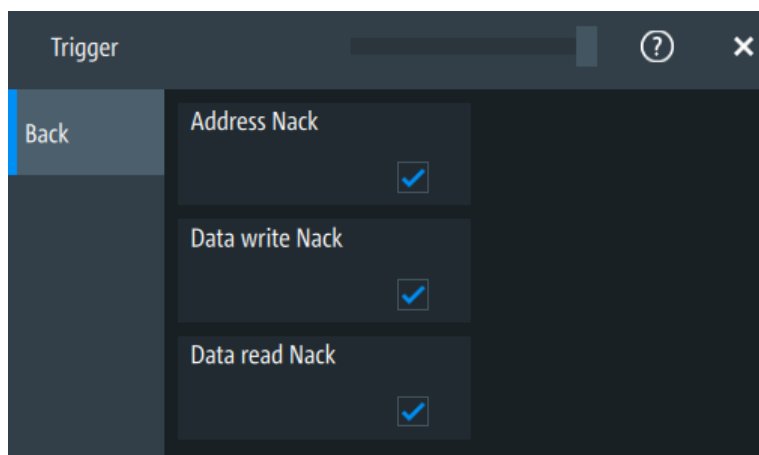

Address ← Type

Sets the trigger to one specific address condition or a combination of address conditions. The trigger time is the falling clock edge of the acknowledge bit after the address.

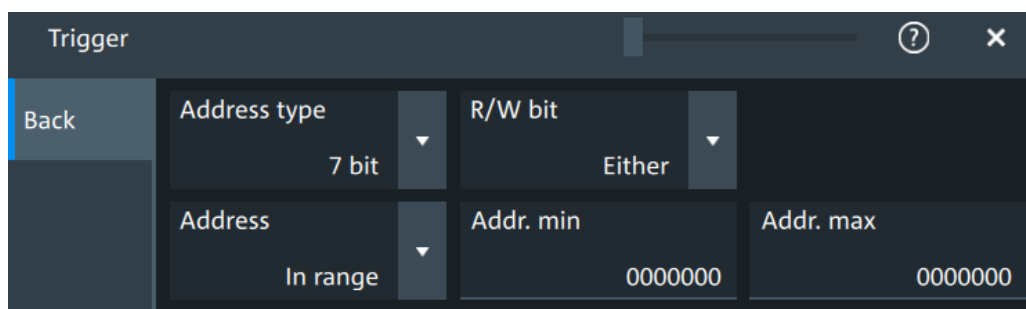

Data ← Type

Sets the trigger to one specific data condition or a combination of address conditions.

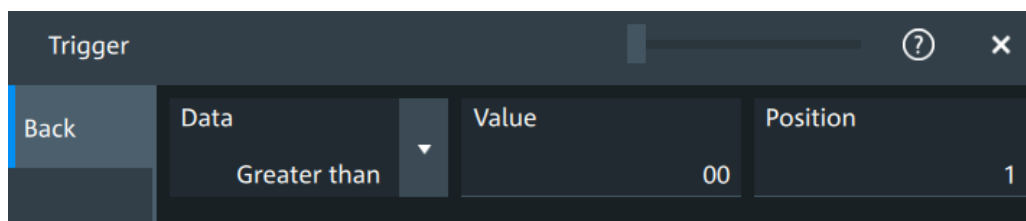

Address and data ← Type

Sets the trigger to a combination of address and data condition.

Back	Address type 7 bit	R/W bit Either	
	Address In range	From 00	To 00
	Data Less or equal	Value 00	Position 1

No Ack conditions

Selects which missing acknowledge bits is detected if the trigger type is set to "No Ack".

"Address Nack"

No secondary recognizes the address.

"Data write Nack"

The addressed secondary does not accept the data.

"Data read Nack"

Marks the end of the read process when the primary reads data from the secondary. This Nack is sent according to the protocol definition, it is not an error.

Remote command:

[TRIGger: I2C:ADNack](#) on page 671

[TRIGger: I2C:DWNack](#) on page 673

[TRIGger: I2C:DRNack](#) on page 672

Address type

Sets the address length to be triggered on: 7 bit or 10 bit.

Remote command:

[TRIGger: I2C:AMODe](#) on page 672

R/W bit

Toggles the trigger condition between read and write access of the primary. Select "Either" if the transfer direction is not relevant for the trigger condition.

Remote command:

[TRIGger: I2C:ACCess](#) on page 670

Address

The trigger address setup consists of a comparison condition and one or two address patterns.

Defines the bit pattern of the secondary device address. The length of the entry is adjusted to the selected address type.

"Condition" Sets the comparison condition to a specific value or a range.

"From"	Specifies the value or sets the start value of a range.
"To"	Sets the maximum value of a range for "Condition" = "In range"/"Out of range".

Remote command:

[TRIGger:I2C:ADDRESS](#) on page 671

[TRIGger:I2C:ADDTTo](#) on page 671

Data

Specifies the trigger conditions for the data bit pattern.

"Condition"	Sets the comparison condition to a specific value or a range.
"Value"	Specifies the value or sets the start value of a range. Enter the bytes in msb first bit order. The maximum pattern length is 64 bit. Waveform data is compared with the pattern byte-by-byte.

Remote command:

[TRIGger:I2C:DCondition](#) on page 672

[TRIGger:I2C:DMIN](#) on page 672

Position

Sets the number of data bytes to be skipped after the address.

Remote command:

[TRIGger:I2C:DPosition](#) on page 672

13.3.5 I²C decode results

When the configuration of the serial bus is complete, the signal can be decoded:

1. Open the "Serial Bus" dialog for the respective bus.
2. In the "Setup" tab, enable "State".
3. In the "Display" tab, enable "Show decode table".

For a description of the display settings, see also [Chapter 13.1.3, "Display"](#), on page 288.

The instrument captures and decodes the signal according to the standard definition and the configuration settings.

The color-coding of the various protocol sections and errors simplifies the interpretation of the visual display. The decode information condenses or expands, depending on the horizontal scale. Various data formats are available to show the result values.

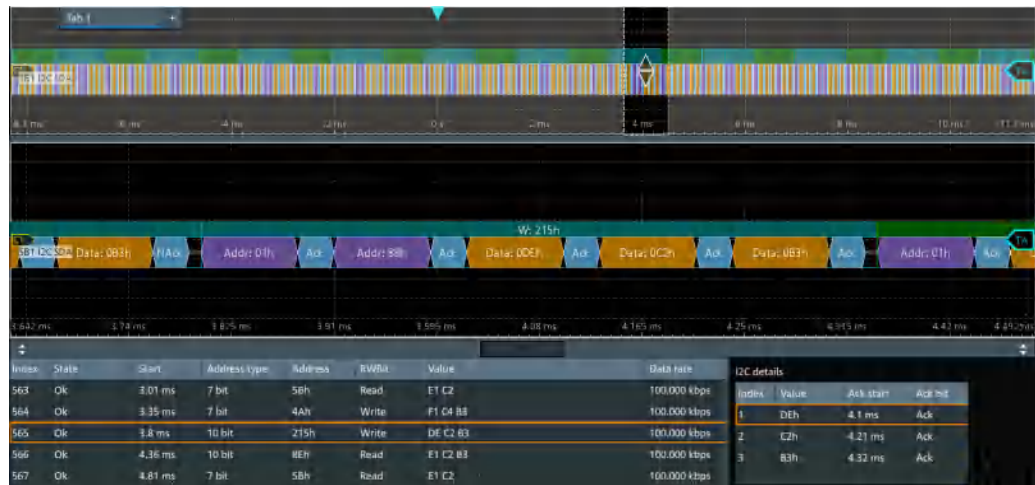

Figure 13-8: Decoded I2C signal, and decode results

Purple	= Address byte
Blue	= R/W bit
Cyan	= ACK bit
Red	= NACK bit
Gold	= Data byte
Turquoise	= Write frame
Green	= Read frame
Crimson red	= Incomplete frame

The results are shown in two tables:

- "Decode results": contains information about all decoded frames
- "Details frame": contains more detailed information about the selected frame in the "Decode results" table.

Decode results table

The "Decode results" table contains information about all decoded frames.

Table 13-2: Content of the Decode results table

Column	Description
Index	Index of the decoded frame
State	Overall state of the frame. "Insufficient waveform length" indicates that the frame is not completely contained in the acquisition. Change the horizontal scale, or move the reference point to the left to get a longer acquisition.
Start	Time of frame start
Address type	Address length, 7 bit or 10 bit
Address value (hex)	Hexadecimal value of the address
R/W bit	Value of the R/W bit
Data rate	Value of the data rate

Table 13-3: Content of the Details results table

Column	Description
Index	Index of the decoded field
Value	Value of all data bytes of the frame
ACK bit start	Start time of the acknowledge bit
ACK bit	Value of the address acknowledge bit

Data format

You can select various data formats for the values displayed in the decode table and in the combs of the decoded signal.

Remote command:

- `SBUS<sb>:FORMat` on page 645

Export of decode results

1. In the protocol "Shortcuts" tab, press "Export results".
The "Export results" dialog opens.
For details, see [Chapter 13.1.7, "Export protocol results"](#), on page 291.
2. Select the details that you want to export and the file format.
3. Tap "Save as".
4. Key in a name and select the file format.

Remote commands

Remote commands to retrieve decode results are described in [Chapter 17.16.3.4, "Decode results"](#), on page 677.

13.3.6 Performing I2C decoding

This chapter explains step by step how to configure and decode the I2C bus.

For more information on decoding I2C, you can also refer to the video, available on the Rohde & Schwarz YouTube channel: [Decoding I2C with MXO Series Oscilloscope](#).

13.3.6.1 Configuring I2C signals

For configuration, assign the lines to the input channels, and define the active states and the logical thresholds.

For details on configuration settings, see [Chapter 13.3.2, "I2C configuration"](#), on page 311.

1. Tap the "Bus" activator in the bottom right of the screen.

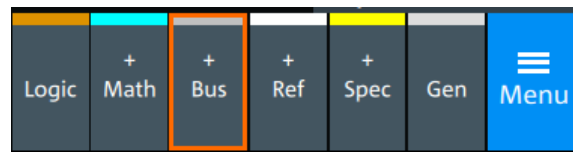

2. Select the tab of the bus that you want to set up, for example "SB1".
3. Tap the "Protocol type" button. Select the protocol: "I2C".
4. Tap on "State" to enable the decoding.

An I2C shortcut appears at the bottom left of the screen. Tap on the shortcut for a quick access to the "I2C" dialog settings.



5. Tap on each active wire and select the correct channels: "SDA source" and "SCL source".
6. Check that the signals are on the screen.
If not try adjusting the vertical and horizontal settings.



7. Set the logical thresholds:
 - a) Tap "Threshold setup". The threshold dialog opens.
 - b) For each wire, set the threshold value. A typical value is 1.65 V.
 - c) If necessary, set the hysteresis value for the wires.
 - d) Optionally, tap on "Show threshold lines".

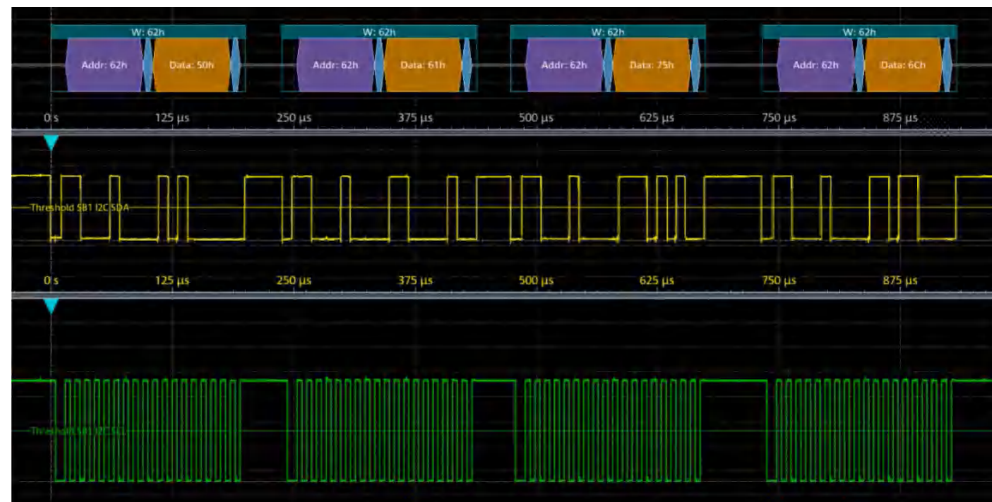

13.3.6.2 Triggering on I2C

Prerequisites: A bus is configured for the I2C signal to be analyzed. See [Chapter 13.3.6.1, "Configuring I2C signals"](#), on page 322.

1. Open "Menu" > "Trigger".
2. Set "Trigger on" to "Single event".
3. Ensure that the "Source" is set to the configured serial bus, e.g. "Serial bus 1".
4. Select the "Type".
5. Define additional settings for more complex trigger types: "No Ack", "Address", "Data", "Address + Data".
 - a) Tap on "Set details".
 - b) Set the "Data" condition and "Value".
 - c) Set the "Position".

In the following example a decode for triggering on triggered on "Data" = 0x75, "Position" = 1.

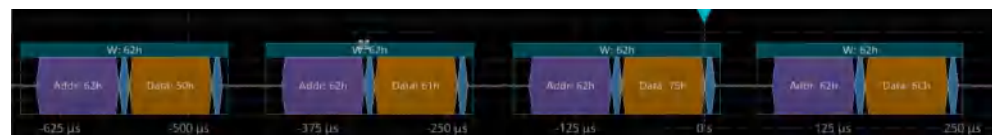

Figure 13-9: Trigger on Type=Data, Data=0x75 and Position=1

13.3.6.3 Exporting decode results

Once a decode has been completed, you can export the decode results of the

Prerequisites: A bus is configured for the I2C and decoded.

1. Tap on the "I2C" shortcut.
2. Tap on the "Shortcuts" tab.
3. Tap "Export results".
4. If necessary, enable "Include details".
5. If necessary, enable "Include timing".
6. Select the "File type".

An export file is saved in the selected directory.

The I2C export files contain the following fields:

- A list of all decoded frames:
 - Index
 - Start
 - Stop
 - State
 - Address type
 - Address value
 - R/W bit
 - Bit rate
- The details frames include the following fields:
 - Index
 - Formatted data
 - ACK bit start
 - ACK bit

Example of I2C export file

```
Index,Start,Stop,State,Address type,Address value,R/W bit,Bit rate
1,-0.25,-0.24945,'OK','BIT10',188h,'WRIT',100000
2,-0.24944,-0.249,'OK','BIT10',1h,'READ',100000
3,-0.24899,-0.24866,'OK','BIT7',5Bh,'READ',100000
4,-0.24865,-0.24821,'OK','BIT7',4Ah,'WRIT',100000
5,-0.2482,-0.24765,'OK','BIT10',188h,'WRIT',100000
6,-0.24764,-0.2472,'OK','BIT10',1h,'READ',100000
```

Details frame 1

```
Index,Formatted data,Ack bit start,Ack bit
1,DEh,-0.2497,'ACK'
2,C2h,-0.24959,'ACK'
3,B3h,-0.24948,'ACK'
```

Details frame 2

```
Index,Formatted data,Ack bit start,Ack bit
```

```
1,E1h,-0.24925,'ACK'  
2,C2h,-0.24914,'ACK'  
3,B3h,-0.24903,'ACK'  
  
Details frame 3  
Index,Formatted data,Ack bit start,Ack bit  
1,E1h,-0.2488,'ACK'  
2,C2h,-0.24869,'ACK'  
  
Details frame 4  
Index,Formatted data,Ack bit start,Ack bit  
1,F1h,-0.24846,'ACK'  
2,C4h,-0.24835,'ACK'  
3,B3h,-0.24824,'NACK'  
  
Details frame 5  
Index,Formatted data,Ack bit start,Ack bit  
1,DEh,-0.2479,'ACK'  
2,C2h,-0.24779,'ACK'  
3,B3h,-0.24768,'ACK'
```

13.4 UART (option R&S MXO5-K510)

The Universal Asynchronous Receiver/Transmitter UART converts a word of data into serial data, and vice versa. It is the base of many serial protocols such as RS-232.

Required options and equipment

For performing UART decode measurements, you need the following equipment:

- R&S MXO 5 with 2 available channels. The channels can be a combination of the following:
 - Analog channels (C1-C4)
 - Logic channels (D0-D15) (requires option R&S MXO5-B1)
- Option R&S MXO5-K510
- Two probes

13.4.1 About the UART / RS-232 interface

The UART uses only one line, or two lines for transmitter and receiver.

Data transfer



Figure 13-10: Bit order in a UART word (symbol)

- The start bit is a logic 0.
- The stop bits and the idle state are always logic 1.

The UART protocol has no clock for synchronization. The receiver synchronizes by the start and stop bits, and the bit rate that must be known to the receiver.

Trigger

The R&S MXO 5 can trigger on specified parts of UART serial signals:

- Start bit
- Parity errors, and breaks
- A serial pattern at any or a specified position

13.4.2 UART configuration

13.4.2.1 UART configuration settings

Access: [Apps] key > "Protocol" tab > "UART / RS232" > "Setup".

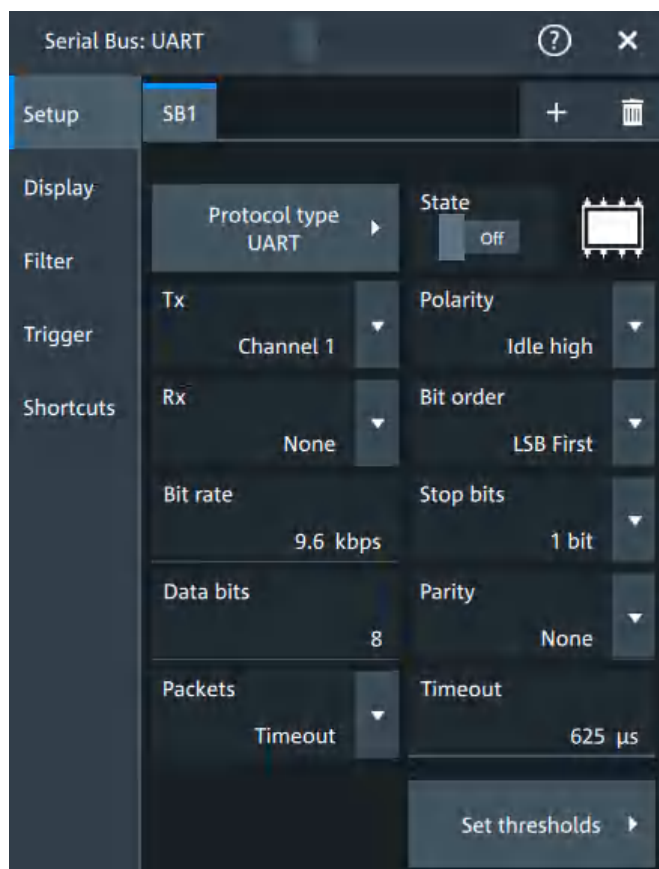
**Protocol type**

Displays the protocol type to be decoded.

Remote command:

[SBUS<sb>:TYPE](#) on page 645

State

Enables the decoding of the selected bus. The signal icon of the bus appears on the signal bar.

Source: Tx, Rx

Select the input channels for the transmitter and receiver signals.

Do not combine a reference waveform with channel or math waveform because the time correlation of these waveforms might differ.

Remote command:

[SBUS<sb>:UART:TX:SOURce](#) on page 690

[SBUS<sb>:UART:RX:SOURce](#) on page 688

Bit order

Selects the bit order, which determines if the data of the messages starts with MSB (most significant bit) or LSB (least significant bit).

Remote command:

[SBUS<sb>:UART:BORDER](#) on page 686

Polarity

Defines the logic levels of the bus. The idle state corresponds to a logic 1. The start bit corresponds to a logic 0. "Idle high" (high=1) is used, for example, for control signals, while "Idle low" (low=1) is defined for data lines (RS-232).

Remote command:

[SBUS<sb>:UART:POLarity](#) on page 688

Bit rate

Sets the number of transmitted bits per second.

Remote command:

[SBUS<sb>:UART:BITRate](#) on page 686

Stop bits

Sets the number of stop bits: 1 or 1.5 or 2 stop bits are possible.

Remote command:

[SBUS<sb>:UART:SBIT](#) on page 689

Data bits

Sets the number of data bits of a word in a range from 5 bits to 8 bits. If no parity bit is used, then 9 data bits are possible.

Remote command:

[SBUS<sb>:UART:SSIZE](#) on page 689

Parity

Defines the optional parity bit that is used for error detection.

"None"	No parity bit is used.
"Odd"	The parity bit is set to "1" if the number of data bits set to "1" is even.
"Even"	The parity bit is set to "1" if the number of data bits set to "1" is odd.
"Mark"	The parity bit is always a logic 1.
"Space"	The parity bit is always a logic 0.
"Don't care"	The parity is ignored.

Remote command:

[SBUS<sb>:UART:PARity](#) on page 687

Packets

Allows you to define packets of several words in the data stream.

"None"	Packets are not considered.
"End word"	Defines a pattern as end condition of a packet, for example, a reserved word like CR or LF. The bit pattern editor provides frequently used values in the "Predefined values" list below the pattern table. A new packet starts with the first start bit after the defined end pattern.
"Timeout"	Defines a timeout between a stop bit and the next start bit. Enter the minimum time that marks the end of a packet. A new packet starts with the first start bit after the timeout.

Remote command:

[SBUS<sb>:UART:PACKets](#) on page 687

[SBUS<sb>:UART:TOUT](#) on page 690

[SBUS<m>:UART:EWORd](#) on page 687

Threshold

Press "Set thresholds", to open the "Threshold setup" dialog.

Enter the value directly in the field of the threshold setup dialog.

Additional to the threshold, you can also set a hysteresis.

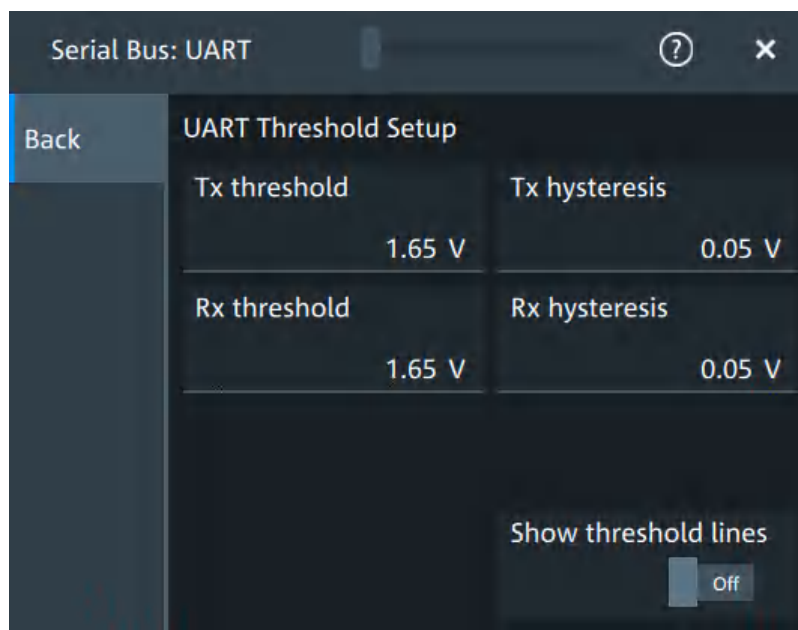

Remote command:

[SBUS<sb>:UART:RX:HYSTeresis](#) on page 688

[SBUS<sb>:UART:RX:THReshold](#) on page 689

[SBUS<sb>:UART:TX:HYSTeresis](#) on page 690

[SBUS<sb>:UART:TX:THReshold](#) on page 690

Show threshold lines ← Threshold

If enabled, the threshold lines are displayed in the diagram.

The label of the threshold line is set according to the signal that it is referring to.

Remote command:

[SBUS<m>:THReshold](#) on page 646

13.4.2.2 Display settings

For details about the display settings, see [Chapter 13.1.3, "Display"](#), on page 288.

13.4.2.3 Shortcuts

For details about the available shortcuts, see [Chapter 13.1.6, "Shortcuts"](#), on page 290.

13.4.3 UART filter

Access:[Apps] key > "Protocol" tab > "UART / RS232" > "Filter" tab

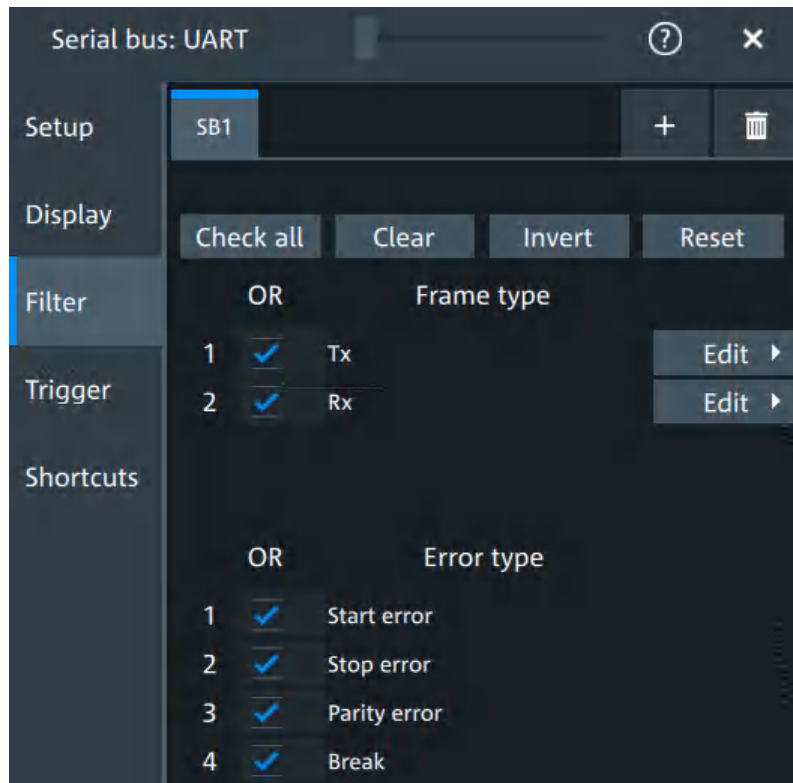

In the "Filter" tab, you can define the settings to display only the frames that match the selected filter conditions.

Check all, Clear, Invert, Reset

The following settings help you select the frames and errors you want to filter for. Only the frames and error types that match the selected filter conditions are displayed.

- "Check all" Enables the filter for all available frames and error types.
- "Clear" Disables the filter for all available frames and error types.
- "Invert" Inverts the current state of the frame and error types: all frames and error types that were enabled are disabled and vice versa.
- "Reset" Resets the state of the selected frames and error types.

Frame type

Selects the frame type that you want to display. You can filter all enabled frame types simultaneously.

For each frame type, you can also specify conditions for the value of the fields in the "Edit" dialog.

The available frames are "Tx", "Rx".

Remote command:

[SBUS<sb>:UART:FILTer:FRAMe<fr>:ENABle](#) on page 697

[SBUS<sb>:UART:FILTer:FRENable](#) on page 697

Edit

Opens a dialog to define the details of the selected frame.

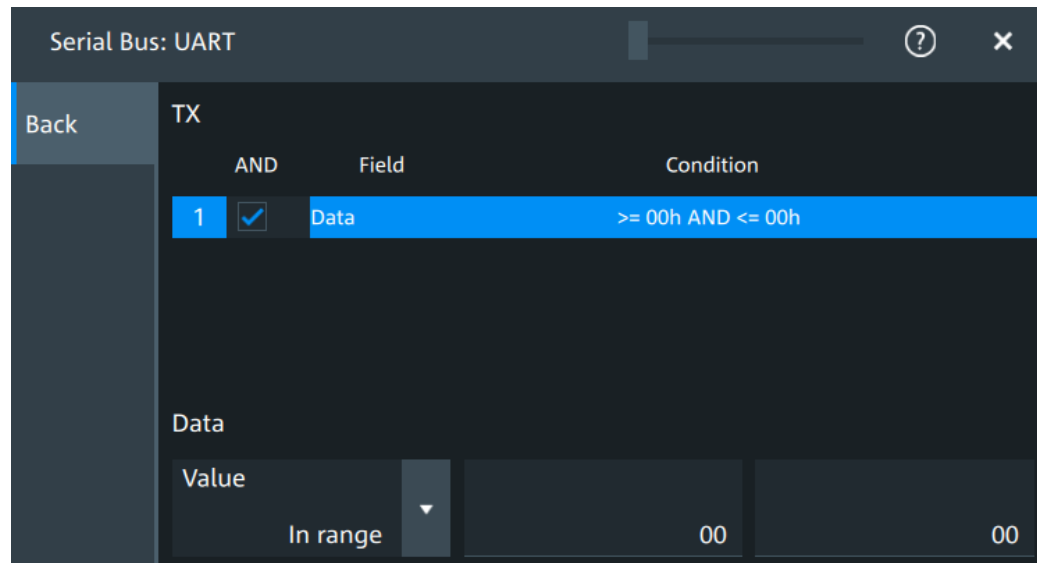

"Field" Enables the field type that you want to filter on for the selected frame. The available field is "Data".

Remote command:

[SBUS<sb>:UART:FILTer:FIENable](#) on page 697

[SBUS<sb>:UART:FILTer:FRAMe<fr>:FLD<fl>:ENABle](#)
on page 697

"Condition" Displays the value condition for the selected field.

Remote command:

[SBUS<sb>:UART:FILTer:FRAMe<fr>:FLD<fl>:BIT](#)
on page 696

"Data"	<p>The data setup consists of a comparison condition and one or two data patterns.</p> <p>Remote command:</p> <p>SBUS<sb>:UART:FILTer:FRAMe<fr>:FLD<fl>:DMAX on page 696</p> <p>SBUS<sb>:UART:FILTer:DMAX on page 696</p> <p>SBUS<sb>:UART:FILTer:FRAMe<fr>:FLD<fl>:DMIN on page 696</p> <p>SBUS<sb>:UART:FILTer:DMIN on page 696</p> <p>SBUS<sb>:UART:FILTer:FRAMe<fr>:FLD<fl>:DOPerator on page 695</p> <p>SBUS<sb>:UART:FILTer:DOPerator on page 695</p>
"Index"	<p>The index setup consists of a comparison condition and one or two index values.</p> <p>Remote command:</p> <p>SBUS<sb>:UART:FILTer:FRAMe<fr>:FLD<fl>:IMAX on page 694</p> <p>SBUS<sb>:UART:FILTer:IMAX on page 694</p> <p>SBUS<sb>:UART:FILTer:FRAMe<fr>:FLD<fl>:IMIN on page 694</p> <p>SBUS<sb>:UART:FILTer:IMIN on page 694</p> <p>SBUS<sb>:UART:FILTer:FRAMe<fr>:FLD<fl>:IOPerator on page 695</p> <p>SBUS<sb>:UART:FILTer:IOPerator on page 695</p>

Error type

Enables filtering on the selected error type.

Available error types are "Start error", "Stop error", "Parity error", "Break".

Remote command:

[SBUS<sb>:UART:FILTer:ERRor<n>:ENABle](#) on page 695

13.4.4 UART trigger**13.4.4.1 UART trigger settings**

Access: [Apps] > "Protocol" > "UART" > "Shortcuts" > "Setup trigger"

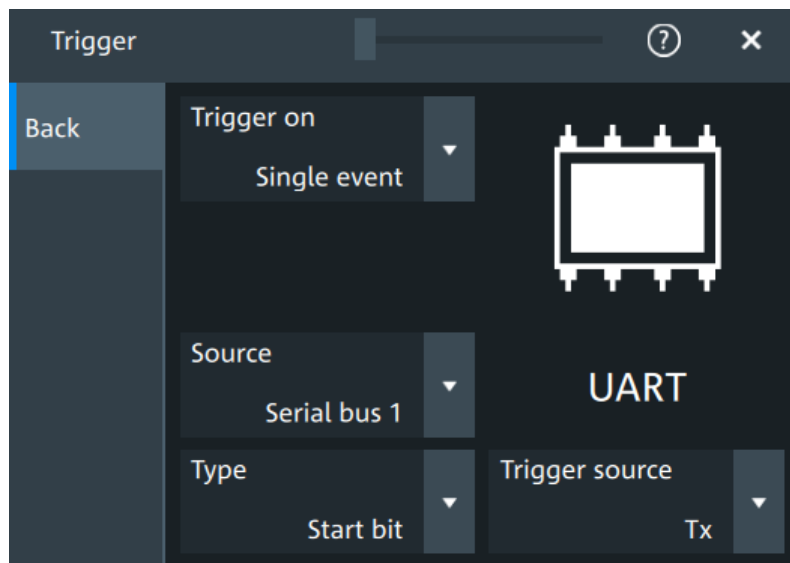
**Type**

Selects the trigger condition.

Some trigger types have additional settings that can be defined. In this case, the "Set details" button appears next to "Type" the function. Open it for a detailed definition of the trigger conditions.

"Start bit"	Triggers on a start bit. The start bit is the first low bit after a stop bit.
"Packet start"	Triggers on the begin of a data packet.
"Data"	Trigger on a serial pattern at a defined position in the data packet. The pattern can include several subsequent symbols (data frames).
"Parity error"	Triggers on a parity error indicating a transmission error. This trigger type is only available if a parity is configured for the UART bus.
"Break condition"	Triggers if a start bit is not followed by a stop bit, the data line remains at logic 0 for longer than a UART word.
"Stop error"	Triggers if the stop bit is a logic 0.

Remote command:

[TRIGger:UART:TYPE](#) on page 693

Trigger source

Selects the transmitter or receiver line as trigger source.

Remote command:

[TRIGger:UART:SOURce](#) on page 693

Data conditions

Specify the data conditions if the trigger type is set to "Data".

Data ← Data conditions

Selects the operator for the "Data" pattern.

Remote command:

[TRIGger:UART:FCONdition](#) on page 692

Value ← Data conditions

Specifies the data pattern to be found on the specified trigger source. Enter the words in MSB first bit order.

Remote command:

[TRIGger:UART:DATA](#) on page 692

Position ← Data conditions

Sets the number of words before the first word of interest. These offset words are ignored.

The setting is available if packet detection is enabled in the protocol configuration.

Remote command:

[TRIGger:UART:DPOsition](#) on page 692

13.4.5 UART decode results

When the configuration of the serial bus is complete, the signal can be decoded:

1. Open the "Serial Bus" dialog for the respective bus.
2. In the "Setup" tab, enable "State".
3. In the "Display" tab, enable "Show decode table".

For a description of the display settings, see also [Chapter 13.1.3, "Display"](#), on page 288.

The instrument captures and decodes the signal according to the standard definition and the configuration settings.

The color-coding of the various protocol sections and errors simplifies the interpretation of the visual display. The decode information condenses or expands, depending on the horizontal scale. Various data formats are available to show the result values.

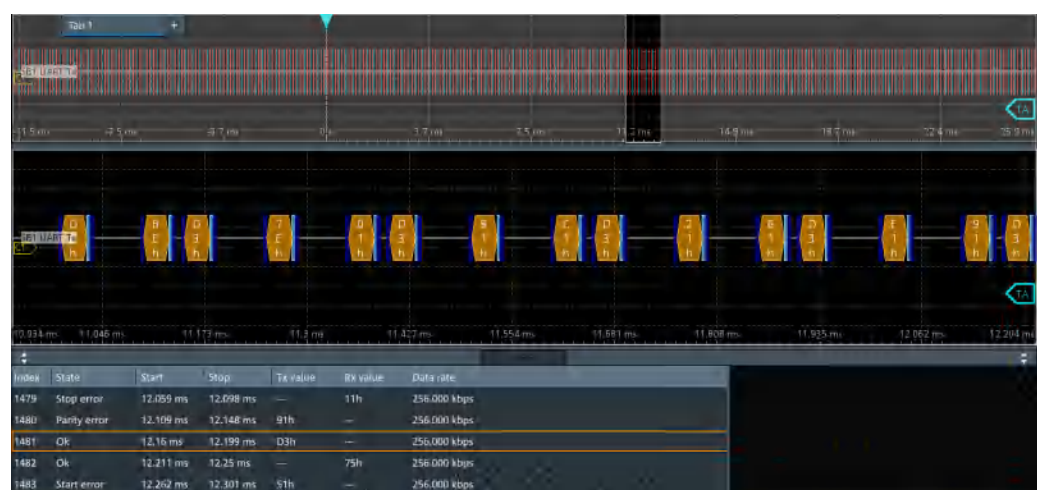

Figure 13-11: Decoded and binary UART signal

Blue = Start and stop bits if ok
 Red = Start error, stop error, parity error
 Cyan = Parity bit if ok
 Gold = Word ok
 Magenta = Word contains error

The "Decode results" table shows the detailed decoded data for each word.

Table 13-4: Content of the Decode results table

Column	Description
Index	Number of the decoded frames
State	Decoding state of the word. "Insufficient waveform length" indicates that the word is not completely contained in the acquisition. Change the horizontal scale, or move the reference point to the left to get a longer acquisition.
Start	Time of the word start (start bit)
Stop	Time of the word stop (stop bit)
Tx value	Value of the Tx word. The data format is selected below the table.
Rx value	Value of the Rx word. The data format is selected below the table.
Data rate	Value of the data rate

Data format

You can select various data formats for the values displayed in the decode table and in the combs of the decoded signal.

Remote command:

- `SBUS<sb>:FORMat` on page 645

Export of decode results

1. In the protocol "Shortcuts" tab, press "Export results".
The "Export results" dialog opens.
For details, see [Chapter 13.1.7, "Export protocol results"](#), on page 291.
2. Select the details that you want to export and the file format.
3. Tap "Save as".
4. Key in a name and select the file format.

Remote commands

Remote commands to retrieve decode results are described in [Chapter 17.16.4.4, "Decode results"](#), on page 697.

13.4.6 Performing UART decoding

This chapter explains step by step how to configure and decode the UART bus.

For more information on decoding UART, you can also refer to the video, available on the Rohde & Schwarz YouTube channel: [Decoding UART with MXO Series Oscilloscope](#).

13.4.6.1 Configuring UART signals

For configuration, assign the lines to the input channels, and define the active states and the logical thresholds.

For details on configuration settings, see [UART configuration](#).

1. Tap the "Bus" activator in the bottom right of the screen.

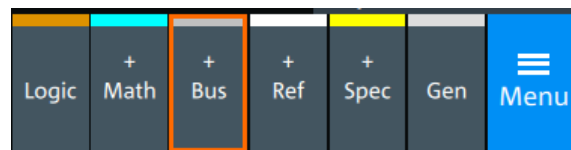

2. Select the tab of the bus that you want to set up, for example "SB1".
3. Tap the "Protocol type" button. Select the protocol: "UART".
4. Tap on "State" to enable the decoding.

An SPI shortcut appears at the bottom left of the screen. Tap on the shortcut for a quick access to the "UART / RS232" dialog settings.

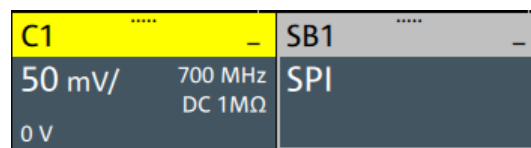

5. Select the correct channels for each active line: "Tx" and "Rx".
6. Set the "Bit rate".
7. Set the "Data bits". Typical value is 7 or 8.
8. Set the "Stop bits". Typical value is 1.
9. Set the "Parity" to "None", "Odd" or "Even".
10. Set "Bit order" to "MSB" or "LSB first".
11. Set the "Packets".
12. Set the "Timeout".
13. Set the "Polarity" to "Idle high" or "Idle low".
14. Check that the signals are on the screen.
If not try adjusting the vertical and horizontal settings.

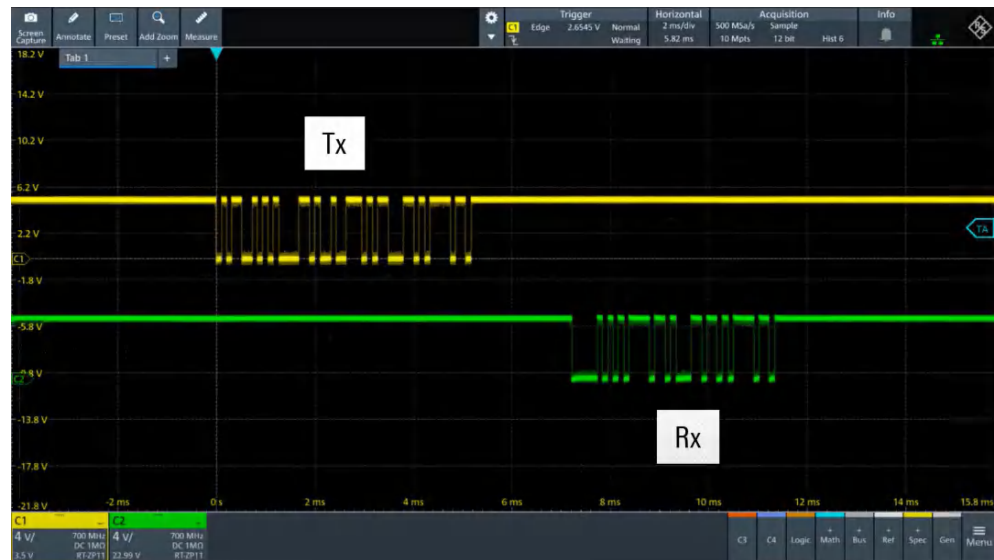

15. Set the logical thresholds:

- Tap "Threshold setup". The threshold dialog opens.
- For each line, set the threshold value. A typical value is 2.5 V.
- If necessary, set the hysteresis value for the wires.
- Optionally, tap on "Show threshold lines".

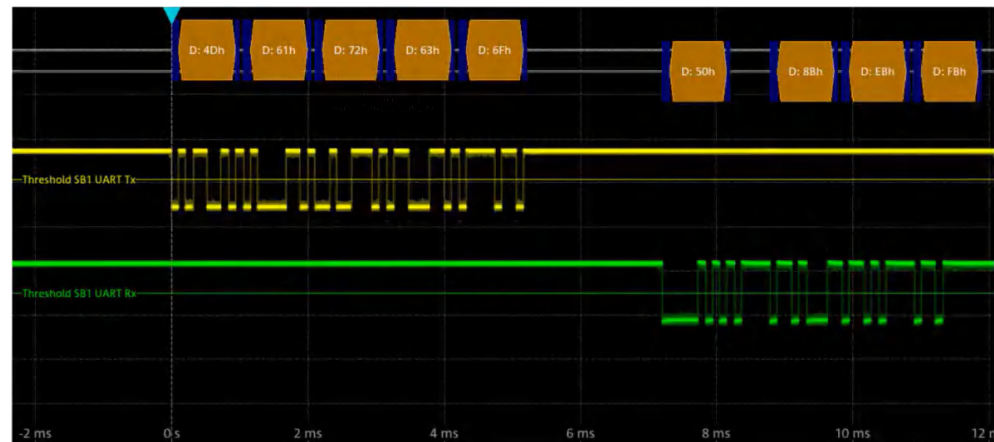

13.4.6.2 Triggering on UART

Prerequisites: A bus is configured for the UART signal to be analyzed. See [Configuring UART signals](#).

- Open "Menu" > "Trigger".
- Set "Trigger on" to "Single event".
- Ensure that the "Source" is set to the configured serial bus, e.g. "Serial bus 1".
- Select the "Type": "Start bit", "Packet start", "Parity error", "Break condition" and "Stop error".

5. Set "Trigger source" to "Tx" or "Rx".
6. Define additional settings for more complex trigger types ("Data"):
 - a) Tap on "Set details".
 - b) Set the "Data" condition and "Value".
 - c) Set the "Position".

In the following example a decode for triggering on TX triggered on "Data"= 0x72 and "Position"= 3.

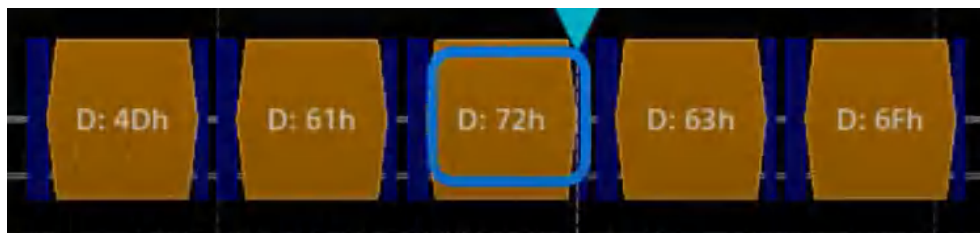

Figure 13-12: Trigger on Type= Tx, Data =0x72 and Position=3

13.4.6.3 Exporting decode results

Once a decode has been completed, you can export the decode results of the

Prerequisites: A bus is configured for the UART and decoded.

1. Tap on the "UART / RS232" shortcut.
2. Tap on the "Shortcuts" tab.
3. Tap "Export results".
4. If necessary, enable "Include details".
5. If necessary, enable "Include timing".
6. Select the "File type".

An export file is saved in the selected directory.

The UART export files contain the following fields:

- Index
- Start
- Stop
- Source
- State
- TX value
- RX value
- Bit rate

Example UART export file

```
Index,Start,Stop,Source,State,Tx value,Rx value,Bit rate
1,-0.0629961,-0.0629531,'TX','OK',33h,---,256000
2,-0.0629453,-0.0629023,'RX','OK',---,F5h,256000
3,-0.0628945,-0.0628516,'TX','STER',C8h,---,256000
4,-0.0628438,-0.0628008,'RX','SPER',---,28h,256000
5,-0.062793,-0.06275,'TX','PRER',A8h,---,256000
```

13.5 CAN (option R&S MXO5-K520)

CAN is the Controller Area Network, a bus system designed by Bosch for use within automotive network architecture, for example, for brake, power train and engine management. Today, it is also used in many other systems, for example, in industrial machines, aerospace, subsea, merchant marine.

With the R&S MXO 5 you can decode frames from some of the most common CAN protocols standards:

- Classical CAN (CAN 2.0): with the standard frame format (11-bit identifier) and the extended frame format (29-bit identifier).
- CAN FD: CAN with flexible data rate. It is an extension of the classical CAN protocol and allows for increased data rates and payloads. It is backward compatible with CAN 2.0.
- CAN XL: an advanced version of the CAN protocol designed to handle higher data rates and larger payloads compared to classical CAN and CAN FD.

Required options and equipment

For performing CAN decode measurements, you need the following equipment:

- R&S MXO 5 with 1 available channel. The channel can be:
 - Analog channels (C1-C4)
 - Logic channels (D0-D15) (requires option R&S MXO5-B1)
- One probe
- Option R&S MXO5-K520

13.5.1 CAN configuration

13.5.1.1 CAN configuration settings

Access: [Apps] key > "Protocol" tab > "CAN" > "Setup".

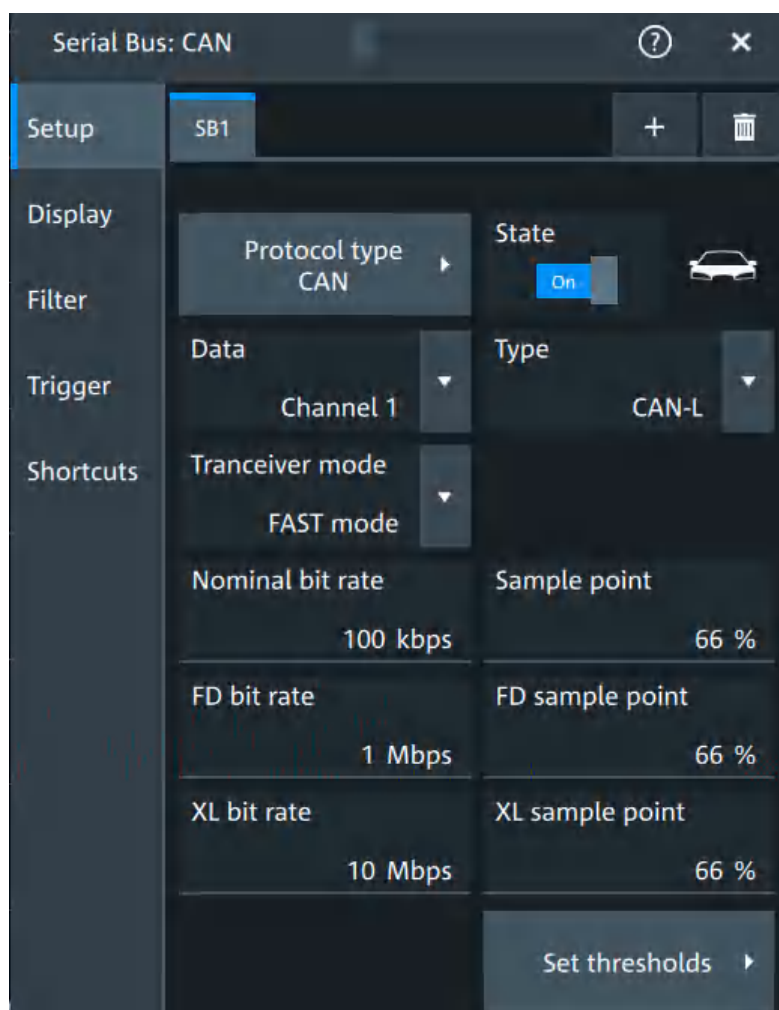

Make sure that the tab of the correct serial bus is selected.

Protocol type

Displays the protocol type to be decoded.

Remote command:

[SBUS<sb>:TYPE](#) on page 645

State

Enables the decoding of the selected bus. The signal icon of the bus appears on the signal bar.

Data

Sets the source of the selected data line.

Remote command:

[SBUS<sb>:CAN:SOURce](#) on page 702

Type

Selects the CAN-High or CAN-Low line. CAN uses both lines for differential signal transmission.

If you measure with a differential probe, connect the probe to both CAN-H and CAN-L lines, and select the data "Type" = *CAN-H*.

If you use a single-ended probe, connect the probe to either CAN_L or CAN_H, and select the data type accordingly.

Remote command:

[SBUS<sb>:CAN:TYPE](#) on page 701

Transceiver mode

Selects the transceiver mode for the CAN decoding.

"SIC mode" Signal improvement capability (SIC) mode. The possible bit rate is up to 8 Mbit.

"FAST mode" Fast mode. The possible bit rate is up to 20 Mbit.

Remote command:

[SBUS<sb>:CAN:TRCVmode](#) on page 704

Nominal bit rate

Sets the number of transmitted bits per second.

Remote command:

[SBUS<sb>:CAN:BITRate](#) on page 701

Sample point

Sets the position of the sample point within the bit in percent of the nominal bit time.

Remote command:

[SBUS<sb>:CAN:SAMPlpoint](#) on page 702

FD bit rate

Sets the number of transmitted bits per second for the CAN FD frame.

Remote command:

[SBUS<sb>:CAN:FDATa:DBITrate](#) on page 702

FD sample point

Sets the position of the sample point within the bit in percent of the nominal bit time for the CAN FD frame.

Remote command:

[SBUS<sb>:CAN:FDATa:SAMPlpoint](#) on page 702

XL bit rate

Sets the number of transmitted bits per second for the CAN XL frame.

Remote command:

[SBUS<sb>:CAN:XDATa:DBITrate](#) on page 704

XL sample point

Sets the position of the sample point within the bit in percent of the nominal bit time for the CAN XL frame.

Remote command:

[SBUS<sb>:CAN:XDATa:SAMPlepoint](#) on page 704

Threshold

Press "Set thresholds", to open the "Threshold setup" dialog.

Enter the value directly in the field of the threshold setup dialog.

Additional to the threshold, you can also set a hysteresis.

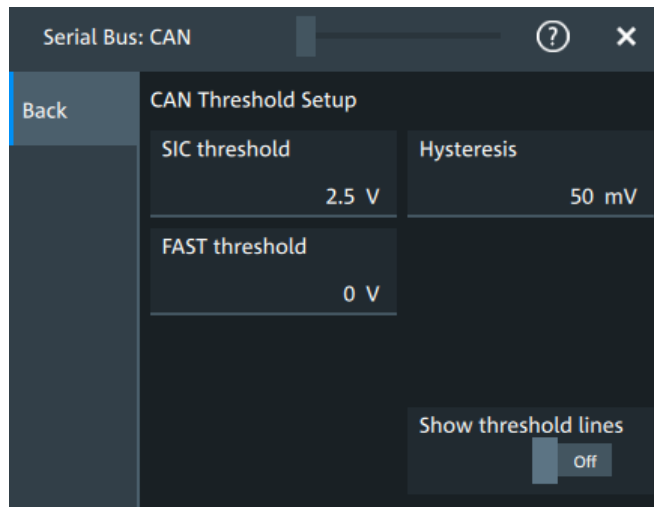

Remote command:

[SBUS<sb>:CAN:FAST:HYSTeresis](#) on page 704

[SBUS<sb>:CAN:FAST:THReshold](#) on page 703

[SBUS<sb>:CAN:SIC:HYSTeresis](#) on page 703

[SBUS<sb>:CAN:SIC:THReshold](#) on page 703

Show threshold lines

If enabled, the threshold lines are displayed in the diagram.

The label of the threshold line is set according to the signal that it is referring to.

Remote command:

[SBUS<m>:THReshold](#) on page 646

13.5.1.2 Display settings

For details about the display settings, see [Chapter 13.1.3, "Display"](#), on page 288.

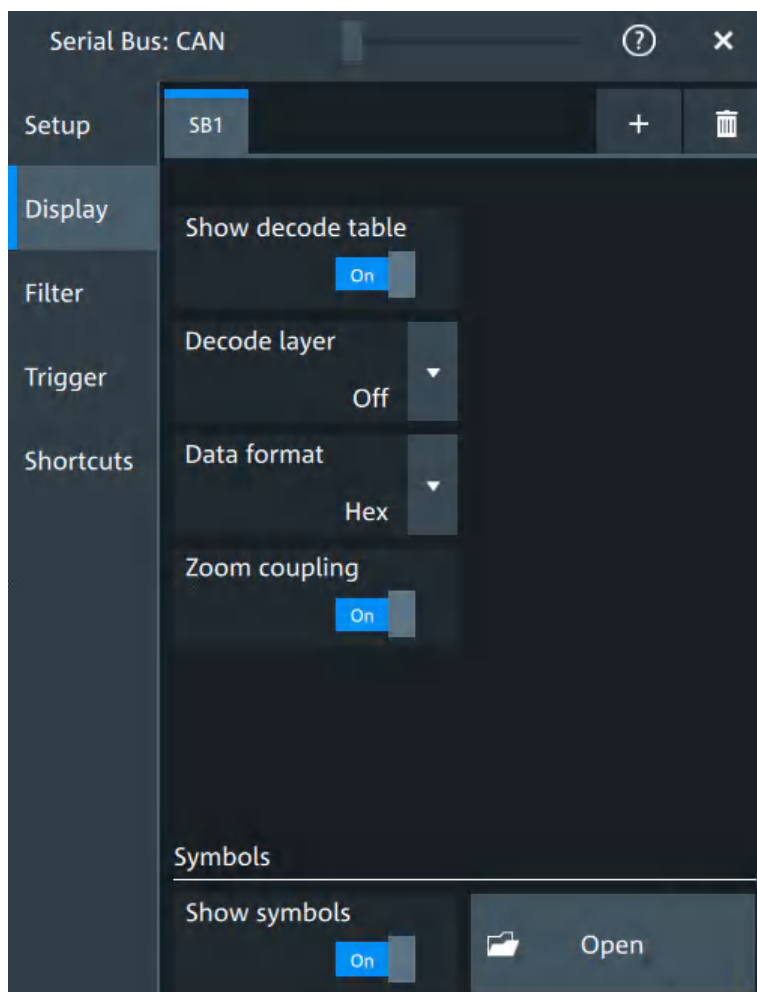

Decode layer

Selects the decode layer.

Decoding is performed in several steps, and the end results are presented in the decode table. The decode layer selects an interim step for which the decoding result is shown in the honeycomb display.

Show symbols

You can load symbol lists, and activate its usage for decoding. As a result, an additional "Symbol" column appears in the "Decode results" table, containing the symbolic label.

Symbol lists for CAN are available in DBC and CSV format, see [CAN symbols](#).

Remote command:

`SBUS<sb>:CAN:SYMBOLs` on page 705

`SBUS<sb>:CAN:NEWLlist` on page 705

13.5.1.3 CAN symbols

For the CAN protocol, you can upload symbol lists containing IDs and a symbolic name for each node. You can load a file in one of the supported formats: DBC and CSV.

DBC files for CAN and CAN FD

Industry standard DBC files contain more information than CSV files and translate the abstract decode results to human language. For each frame, the frame ID and the symbolic name of the ID are given. The frames are also called messages in CAN. The data of a CAN message can consist of several "signals". The DBC file provides the label, unit, start bit, length and other indicators for each signal. For state-encoded signals, the meaning of the states is given.

In the following demo example, the message "EngineData" has the decimal ID 2,166,573,756 and consists of 8 data bytes. These 8 bytes are defined as 6 signals. The first one, "PetrolLevel", starts at bit #24, has a length of 8 bit, and the unit is liter. The signal "IdleRunning" is state-encoded. It has only one bit. The binary value 0 means "Running", and the binary value 1 means "Idle".

Example: CAN DBC file section

```
BO_ 2166573756 EngineData: 8 Engine
  SG_ PetrolLevel : 24|8@1+ (1,0) [0|255] "l" ...
  SG_ EngPower : 48|16@1+ (0.01,0) [0|350] "kW" ...
  SG_ EngForce : 32|10@1+ (1,0) [0|1000] "N" ...
  SG_ IdleRunning : 23|1@1+ (1,0) [0|1] "" ...
  SG_ EngTemp : 16|7@1+ (2,-50) [-50|150] "degC" ....
  SG_ EngSpeed : 0|13@1+ (1,0) [0|8000] "rpm" ...
  ....
  VAL_ 2166573756 IdleRunning 0 "Running" 1 "Idle" ;
```

CSV files for CAN / CAN FD

Symbol list files are protocol-specific. A CSV label file for CAN protocols contains three values for each identifier:

- Identifier type, 11-bit or 29-bit long
- Identifier value
- Symbolic name of the identifier, specifying its function in the bus network.

Example: CAN CSV file

```
# -----
@FILE_VERSION = 1.00
@PROTOCOL_NAME = can
# -----
# Labels for CAN protocol
# Column order: Identifier type, Identifier value, Label
# -----
11,064h,Diag_Response
11,1E5h,EngineData
11,0A2h,Ignition_Info
```

```
11,1BCh,TP_Console
11,333h,ABSdata
11,313h,Door_Left
11,314h,Door_Right
29,01A54321h,Throttle
29,13A00FA2h,LightState
29,0630ABCDh,Engine_Status
29,03B1C002h,Airbag_Status
29,01234ABCh,NM_Gateway
# -----
```

13.5.1.4 Shortcuts

For details about the available shortcuts, see [Chapter 13.1.6, "Shortcuts"](#), on page 290.

13.5.2 CAN filter

Access: [Apps] key > "Protocol" tab > "CAN" > "Filter" tab

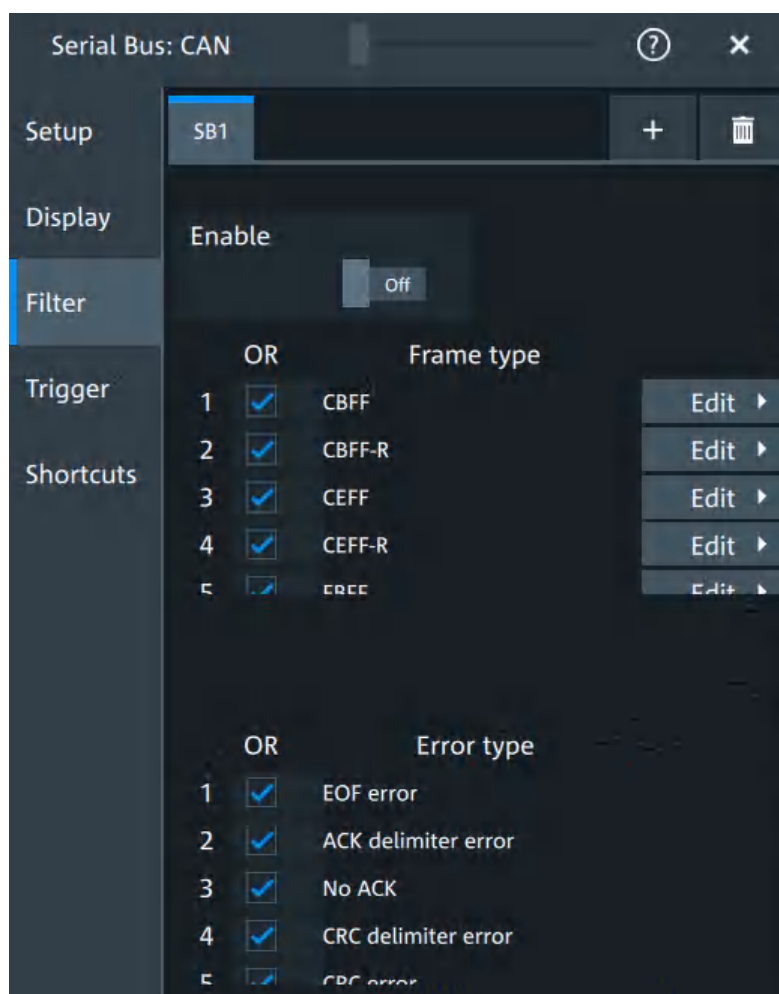

In the "Filter" tab, you can define the settings to display only the frames that match the selected filter conditions.

Check all, Clear, Invert, Reset

The following settings help you select the frames and errors you want to filter for. Only the frames and error types that match the selected filter conditions are displayed.

- "Check all" Enables the filter for all available frames and error types.
- "Clear" Disables the filter for all available frames and error types.
- "Invert" Inverts the current state of the frame and error types: all frames and error types that were enabled are disabled and vice versa.
- "Reset" Resets the state of the selected frames and error types.

Frame type

Selects the frame type that you want to display. You can filter all enabled frame types simultaneously.

For each frame type, you can also specify conditions for the value of the fields in the "Edit" dialog.

Available frames are "CBFF", "CBFF-R", "CEFF", "CEFF-R", "FBFF", "FEFF", "XLFF", "Overload" and "Error".

Remote command:

[SBUS<sb>:CAN:FILTer:FRENAble](#) on page 718

[SBUS<sb>:CAN:FILTer:FRAMe<fr>:ENABle](#) on page 718

Edit

Opens a dialog to define the details of the selected frame.

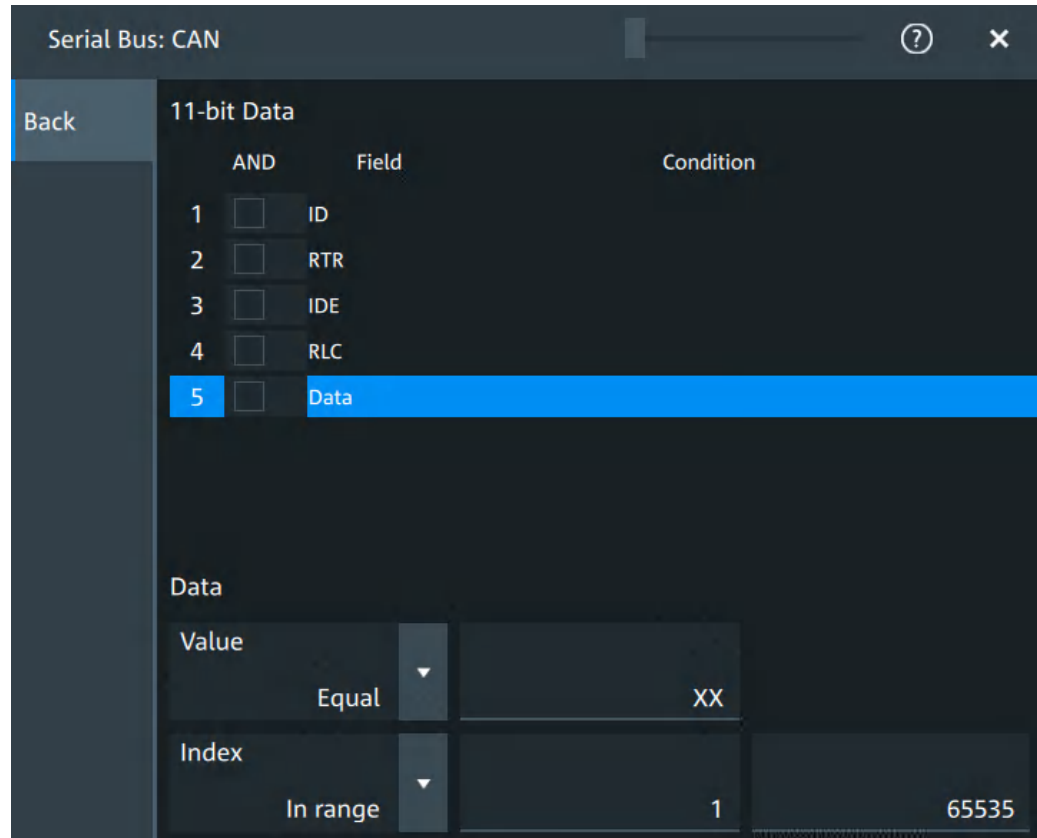

"Field" Enables the field type that you want to filter on for the selected frame. The available fields are "ID", "RTR", "ITE", "RLC" and "Data".

Remote command:

[SBUS<sb>:CAN:FILTer:FIENABle](#) on page 717

[SBUS<sb>:CAN:FILTer:FRAMe<fr>:FLD<fl>:ENABle](#) on page 717

"Condition" Displays the value condition for the selected field.

Remote command:

[SBUS<sb>:CAN:FILTer:BIT](#) on page 716

[SBUS<sb>:CAN:FILTer:FRAMe<fr>:FLD<fl>:BIT](#) on page 716

"Data"	<p>The data setup consists of a comparison condition and one or two data patterns.</p> <p>Remote command:</p> <p>SBUS<sb>:CAN:FILTer:DMAX on page 716</p> <p>SBUS<sb>:CAN:FILTer:FRAMe<fr>:FLD<fl>:DMAX on page 716</p> <p>SBUS<sb>:CAN:FILTer:DMIN on page 716</p> <p>SBUS<sb>:CAN:FILTer:FRAMe<fr>:FLD<fl>:DMIN on page 716</p> <p>SBUS<sb>:CAN:FILTer:DOPerator on page 717</p> <p>SBUS<sb>:CAN:FILTer:FRAMe<fr>:FLD<fl>:DOPerator on page 717</p>
"Index"	<p>The index setup consists of a comparison condition and one or two index values.</p> <p>Remote command:</p> <p>SBUS<sb>:CAN:FILTer:IMAX on page 718</p> <p>SBUS<sb>:CAN:FILTer:FRAMe<fr>:FLD<fl>:IMAX on page 718</p> <p>SBUS<sb>:CAN:FILTer:IMIN on page 718</p> <p>SBUS<sb>:CAN:FILTer:FRAMe<fr>:FLD<fl>:IMIN on page 718</p> <p>SBUS<sb>:CAN:FILTer:IOPerator on page 719</p> <p>SBUS<sb>:CAN:FILTer:FRAMe<fr>:FLD<fl>:IOPerator on page 719</p>

Error type

Enables filtering on the selected error type.

Remote command:

[SBUS<sb>:CAN:FILTer:ERENable](#) on page 717

[SBUS<sb>:CAN:FILTer:ERRor<n>:ENABle](#) on page 717

13.5.3 CAN trigger settings

Access: [Apps] > "Protocol" > "CAN" > "Shortcuts" > "Setup trigger"

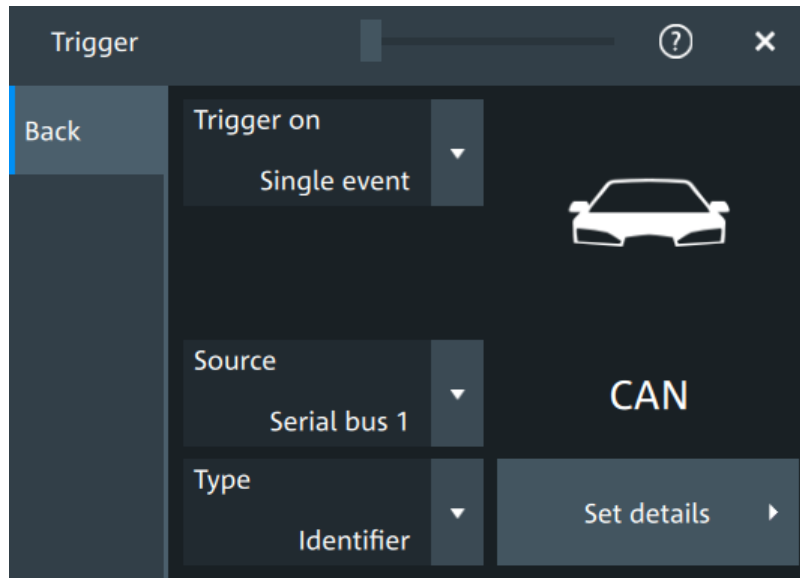

Type

Selects the trigger type for CAN analysis.

Some trigger types have additional settings that can be defined. In this case, the "Set details" button appears next to "Type" the function. Open it for a detailed definition of the trigger conditions.

- "Start of frame" Triggers on the first edge of the dominant SOF bit (synchronization bit).
- "End of frame" Triggers on the end of frame.
- "Frame type" Triggers on a specified frame type (data, remote, error, or overload). For data and remote frames, also the identifier format is considered.

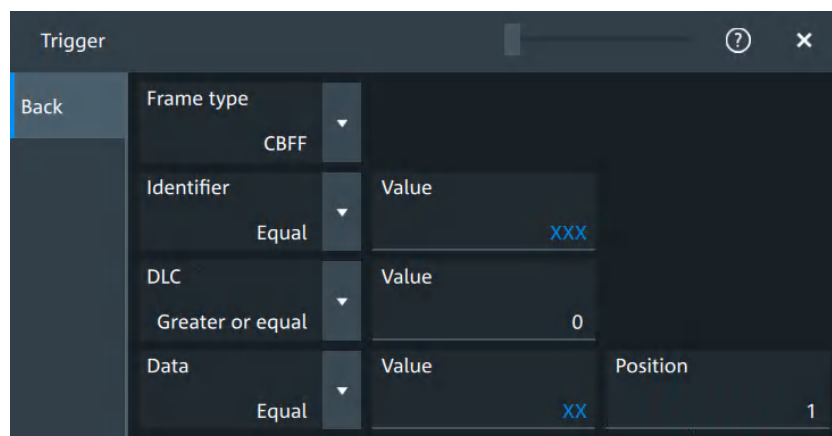

"Identifier" Sets the trigger to a specific message identifier or an identifier range.

The screenshot shows the 'Trigger' configuration window. On the left is a 'Back' button. The main area has a dropdown for 'ID type' set to '11 bit'. Below it, another dropdown for 'Identifier' is set to 'Equal'. To the right of this dropdown is a 'Value' field containing 'XXX'.

"Identifier + Data"

Sets the trigger to a combination of identifier and data condition. The instrument triggers at the end of the last byte of the specified data pattern.

The screenshot shows the 'Trigger' configuration window. On the left is a 'Back' button. The main area has four rows of configuration:

- 'ID type' dropdown set to '11 bit'.
- 'Identifier' dropdown set to 'Equal', with a 'Value' field containing 'XXX'.
- 'DLC' dropdown set to 'Greater or equal', with a 'Value' field containing '0'.
- 'Data' dropdown set to 'Equal', with a 'Value' field containing 'XX' and a 'Position' field containing '1'.

"Error condition"

Identifies various errors in the frame.

The screenshot shows the 'Trigger' configuration window. On the left is a 'Back' button. The main area lists five error conditions, each with a checked checkbox:

- Form error
- Bit stuffing error
- Stuff count error
- Ack error
- Checksum error

Remote command:

[TRIGger:CAN:TYPE](#) on page 707

Frame type

CAN has different frame types which can be used as trigger condition. Depending on the selected frame, you can specify further parameters.

"CBFF" Classical base frame format data: supports a length of 11 bit for the CAN identifier. The data frame is the only frame for actual data transmission.

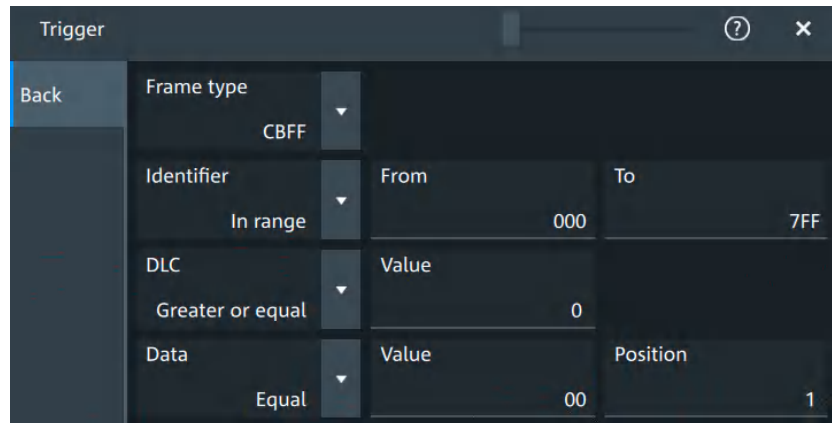

Figure 13-13: Settings for CBFF and CEFF frames

"CBFF-R"

Classical base frame format remote: supports a length of 11 bit for the CAN identifier.

The remote frame initiates the transmission of data by another node. The frame format is the same as of data frames but without the data field.

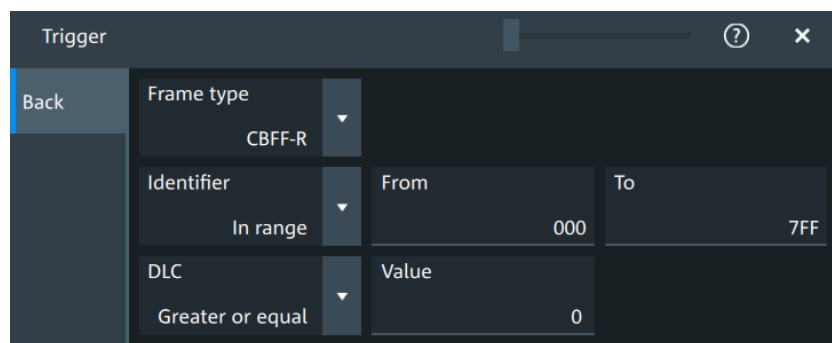

Figure 13-14: Settings for CBFF-R and CEFF-R frames

"CEFF"

Classical extended frame format data: supports a length of 29 bit for the CAN identifier. The data frame is the only frame for actual data transmission.

- "CEFF-R" Classical extended frame format remote: supports a length of 29 bit for the CAN identifier.
The remote frame initiates the transmission of data by another node. The frame format is the same as of data frames but without the data field.
- "FBFF" FD base frame format: supports a length of 11 bit for the CAN identifier.

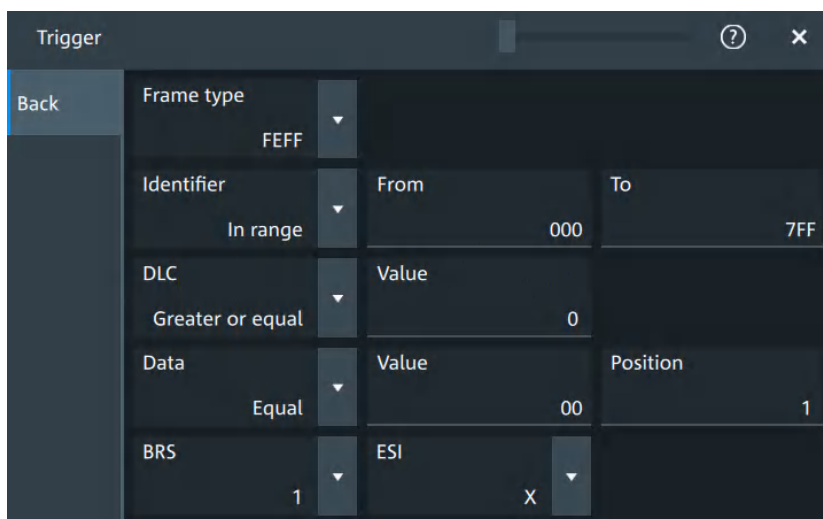

Figure 13-15: Settings for FBFF and FEFF frames

- "FEFF" FD extended frame format: supports a length of 29 bit for the CAN identifier.

"XLFF" XL frame format: supports a length of 29 bit for the CAN identifier.

Parameter	Condition	From	To
Frame type	XLFF		
Identifier	In range	000	7FF
DLC	Greater or equal	Value	0
Data	Equal	Value	Position
		00	1
SDT	In range	From	To
		00	FF
VCID	In range	From	To
		00	FF
AF	In range	From	To
		0000 0000	FFFF FFFF
SEC	0		

"Error" When a node recognizes an error, it cancels transmission by sending an error frame.

The ID type is irrelevant for error frames.

"Overload" When a node needs a delay between data and/or remote frames, it sends an overload frame.

The ID type is irrelevant for overload frames.

Remote command:

[TRIGger:CAN:FTYPE](#) on page 709

Identifier

Specifies the identifier pattern.

"Condition" Sets the comparison condition to a specific value or a range.

"Value"/"From" Specifies the value or sets the start value of a range.

"To" Sets the maximum value of a range for "Condition" = "In range"/"Out of range".

Remote command:

[TRIGger:CAN:ICONdition](#) on page 709

[TRIGger:CAN:IMAX](#) on page 709

[TRIGger:CAN:IMIN](#) on page 710

DLC

The data length code (DLC) defines the number of data bytes to be found. You can set a fixed value for the DLC or define a minimum value.

Remote command:

[TRIGger:CAN:DLC](#) on page 708

[TRIGger:CAN:DLCCondition](#) on page 708

Data pattern

Specifies the data pattern.

"Condition" Sets the comparison condition to a specific value or a range.

"Value" Specifies the value or sets the start value of a range.

Remote command:

[TRIGger:CAN:DCONdition](#) on page 707

[TRIGger:CAN:DMIN](#) on page 708

ID type

Selects the length of the identifier:

"11 bit" Identifier length of the CAN base frame format. The instrument triggers on the sample point of the identifier extension flag (IDE) bit.

"29 bit" Identifier length of the CAN extended frame format. The instrument triggers on the sample point of the remote transmission request (RTR) bit.

"Any" The ID type and ID pattern are not relevant for the trigger condition. If the trigger type is "Identifier", the instrument triggers on any identifier in the specified frame type. If the trigger type is "Identifier + Data", set the "ID type" to "Any" if you want to trigger only on data.

Remote command:

[TRIGger:CAN:ITYPE](#) on page 710

BRS, ESI

If "Frame type" = "FBFF"/"FEFF", you can trigger on specific bits.

"BRS" The bit rate switch bit. Value 1 means that the bit rate switches from the arbitration rate to the faster data rate.

"ESI" The error state indicator bit. Set "X" if the bit is not relevant.

Remote command:

[TRIGger:CAN:FDATa:BRS](#) on page 712

[TRIGger:CAN:FDATa:ESI](#) on page 712

SDT

Specifies a value or a range for the service data unit type.

"Condition" Sets the comparison condition to a specific value or a range.

"Value"/"From" Specifies the value or sets the start value of a range.

"To" Sets the maximum value of a range for "Condition" = "In range"/"Out of range".

Remote command:

[TRIGger:CAN:XDATA:SDT:CONDition](#) on page 713

[TRIGger:CAN:XDATA:SDT:MAX](#) on page 713

[TRIGger:CAN:XDATA:SDT:MIN](#) on page 714

VCID

Specifies a value or a range for the virtual CAN network ID (VCID).

"Condition" Sets the comparison condition to a specific value or a range.

"Value"/"From" Specifies the value or sets the start value of a range.

"To" Sets the maximum value of a range for "Condition" = "In range"/"Out of range".

Remote command:

[TRIGger:CAN:XDATA:VCID:CONDition](#) on page 714

[TRIGger:CAN:XDATA:VCID:MAX](#) on page 715

[TRIGger:CAN:XDATA:VCID:MIN](#) on page 715

AF

Specifies a value or a range for the CAN XL acceptance field (AF).

"Condition" Sets the comparison condition to a specific value or a range.

"Value"/"From" Specifies the value or sets the start value of a range.

"To" Sets the maximum value of a range for "Condition" = "In range"/"Out of range".

Remote command:

[TRIGger:CAN:XDATA:AF:CONDition](#) on page 712

[TRIGger:CAN:XDATA:AF:MAX](#) on page 713

[TRIGger:CAN:XDATA:AF:MIN](#) on page 713

SEC

Sets a value for the simple extended content (SEC) field. It indicates, if the CAN XL data frame uses the CADsec protocol.

Remote command:

[TRIGger:CAN:XDATA:SEC](#) on page 714

Error conditions

If a CAN detects an error, it transmits an error flag at the next bit. The R&S MXO 5 detects errors in the message and triggers on these errors even if no CAN node sends an error flag.

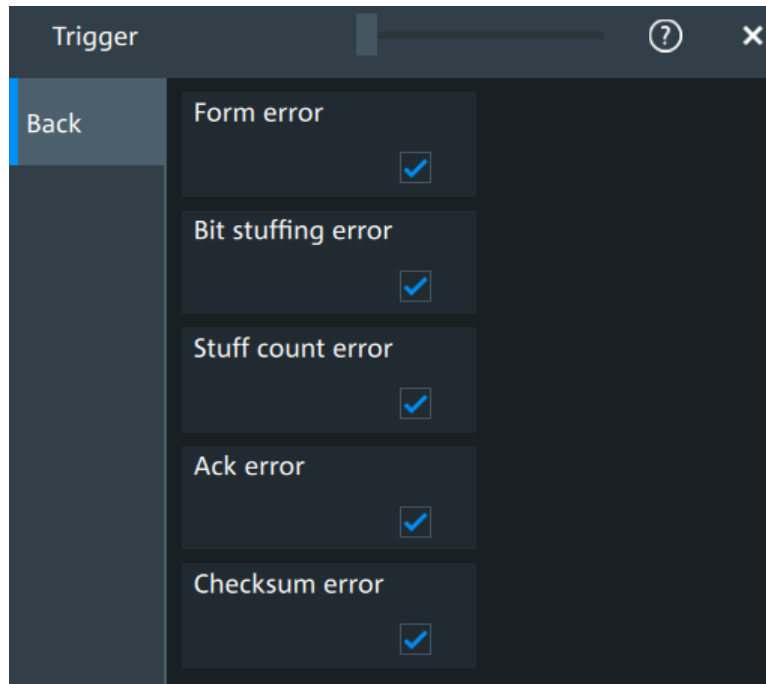

"Form error"	A form error occurs when a fixed-form bit field contains one or more illegal bits.
"Bit stuffing error"	The frame segments Start of Frame, Arbitration Field, Control Field, Data Field and CRC Sequence are coded by the bit stuffing method. The transmitter automatically inserts a complementary bit into the bitstream when it detects five consecutive bits of identical value in the bitstream to be transmitted. A stuff error occurs when the 6th consecutive equal bit level in the mentioned fields is detected.
"Stuff count error"	A stuff bit error occurs, if more than five consecutive bits of the same level occur on the bus.
"Ack error"	An acknowledgment error occurs when the transmitter does not receive an acknowledgment - a dominant bit during the ACK Slot.
"Checksum error"	CAN uses the Cyclic Redundancy Check, which is a complex checksum calculation method. The transmitter calculates the CRC and sends the result in the CRC sequence. The receiver calculates the CRC in the same way. A CRC error occurs when the calculated result differs from the received value in the CRC sequence.

Remote command:

[TRIGger:CAN:FORMerror](#) on page 710

[TRIGger:CAN:BITSterror](#) on page 711

[TRIGger:CAN:FDATa:SCERror](#) on page 710

[TRIGger:CAN:ACKerror](#) on page 711

[TRIGger:CAN:CRCErrror](#) on page 711

13.5.4 CAN decode results

When the configuration of the serial bus is complete, the signal can be decoded:

1. Open the "Serial Bus" dialog for the respective bus.
2. In the "Setup" tab, enable "State".
3. In the "Display" tab, enable "Show decode table".

For a description of the display settings, see also [Chapter 13.1.3, "Display"](#), on page 288.

The instrument captures and decodes the signal according to the standard definition and the configuration settings.

The color-coding of the various protocol sections and errors simplifies the interpretation of the visual display. The decode information condenses or expands, depending on the horizontal scale. Various data formats are available to show the result values.



Green = Identifier
 Bright Green = DLC
 Orange = Data
 Blue = CRC (checksum)
 Purple = End of frame
 Red = Error occurred

The "Decode results" box shows the detailed decoded data for each word.

Table 13-5: Content of the Decode results table

Column	Description
"Index"	Number of the decoded frames
"State"	Overall state of the frame. "Insufficient waveform length" indicates that the frame is not completely contained in the acquisition. Change the horizontal scale, or move the reference point to the left to get a longer acquisition.
"Start"	Time of frame start

Column	Description
"Type"	Frame type
"Symbol"	Symbolic name defined in the symbol list
"Identifier"	Identifier value, hexadecimal value
"DLC"	Data length code, coded number of data bytes
"Values"	Value of the data frame. Remote frames do not transmit data, therefore "- -" is displayed
"Nominal bit rate"	Number of bits per second
"Data bit rate"	Number of data bits per second

Table 13-6: Content of the Detail results table

Column	Description
"Field"	Field type. Values depend on the decoded frame "Type", see Table 13-8 .
"Value"	Value of the corresponding field

Table 13-7: Content of the Data results table

Column	Description
"Index"	Number of the decoded fields
"State"	Overall state of the frame
"Value"	Value of the field

Depending on the decoded type of frame, the following fields are available:

Table 13-8: Decoded fields depending on the frame type

Frame	Fields
CBFF/CBFF-R	CRC: cyclic redundancy checks
CEFF/CEFF-R	CRC: cyclic redundancy checks
FBFF/FEFF	BRS: bit rate switch
	ESI: error state indicator
	SBC: stuff bit count
	CRC: cyclic redundancy checks
XLFF	SBC: stuff bit count
	SDT: service data unit
	SEC: simple extended content
	VCID: virtual CAN network ID
	AF: acceptance field
	PCRC: preamble cyclic redundant check
	FCRC: frame CRC

Data format

You can select various data formats for the values displayed in the decode table and in the combs of the decoded signal.

Remote command:

- `SBUS<sb>:FORMat` on page 645

Export of decode results

1. In the protocol "Shortcuts" tab, press "Export results".

The "Export results" dialog opens.

For details, see [Chapter 13.1.7, "Export protocol results"](#), on page 291.

2. Select the details that you want to export and the file format.
3. Tap "Save as".
4. Key in a name and select the file format.

Remote commands

Remote commands to retrieve decode results are described in [Chapter 17.16.5.4, "Decode results"](#), on page 719.

13.5.5 Performing CAN decoding

This chapter explains step by step how to configure and decode the CAN bus.

13.5.5.1 Configuring CAN signals

For configuration, assign the lines to the input channels, and define the active states and the logical thresholds.

For details on configuration settings, see [Chapter 13.5.1, "CAN configuration"](#), on page 340.

1. Tap the "Bus" activator in the bottom right of the screen.

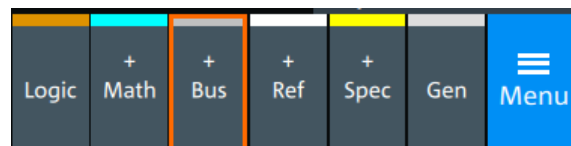

2. Select the tab of the bus that you want to set up, for example "SB1".
3. Tap the "Protocol type" button. Select the protocol: CAN.
4. Tap on "State" to enable the decoding.

An SPI shortcut appears at the bottom left of the screen. Tap on the shortcut for a quick access to the "SPI" dialog settings.

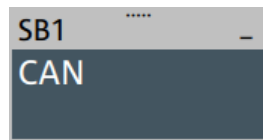

5. Tap on each active wire and select the correct channels: "SCLK", "MOSI", "MISO", "CS".
6. Set "Bit order" to "MSB" or "LSB first".
7. Set "Clock polarity" to "Rising edge" (CPOL = 0) or "Falling edge" (CPOL = 1).
8. Set "MOSI polarity"/"MISO polarity" to "Active high"(CPHA = 0) or "Active low"(CPHA = 1).
9. Set "CS polarity" to "Active high" or "Active low".
The typical value is "Active low", which means that the line is pulled low on message start.
10. Set the "Word length". The typical value is 8.
11. Check that the signals are on the screen.
If not try adjusting the vertical and horizontal settings.
12. Set the logical thresholds:
 - a) Tap "Threshold setup". The threshold dialog opens.
 - b) For each wire, set the threshold value.
 - c) If necessary, set the hysteresis value for the wires.
 - d) Optionally, tap on "Show threshold lines".

13.5.5.2 Triggering on CAN

Prerequisites: A bus is configured for the CAN signal to be analyzed. See [Chapter 13.5.5.1, "Configuring CAN signals"](#), on page 360.

1. Open "Menu" > "Trigger".
2. Set "Trigger on" to "Single event".
3. Ensure that the "Source" is set to the configured serial bus, e.g. "Serial bus 1".
4. Select the "Type".
5. For "Type" = "Frame type":

- a) Tap on "Set details".

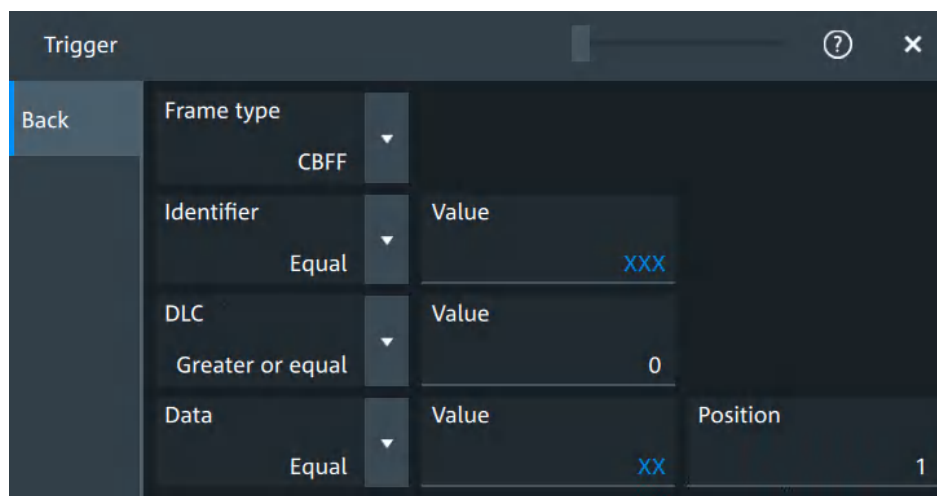

- b) Select the "Frame type". According to the selected type, different settings are available.
- c) Set the "Identifier" or an identifier range.
- d) Set the "DLC" or a DLC range.
- e) Set the "Data" or a data range.
- f) Set the "ESI" value.
- g) Set the "BRS" value.
6. For "Type" = "Identifier":
- a) Tap on "Set details".

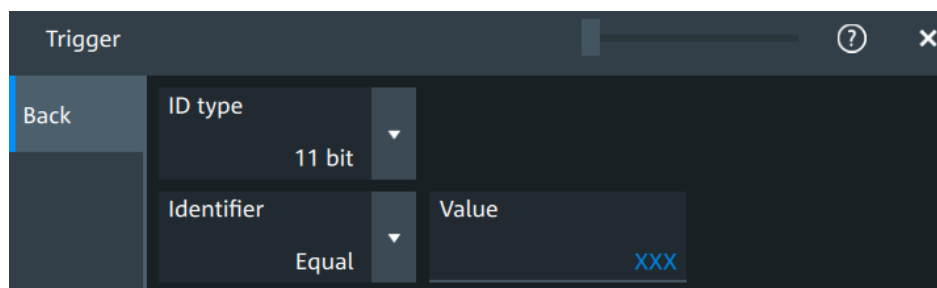

- b) Select the "ID type".
- c) Set the "Identifier" or an identifier range.
7. For "Type" = "Identifier + Data":

- a) Tap on "Set details".

Parameter	Value	Position
ID type	11 bit	
Identifier	Equal	XXX
DLC	Greater or equal	0
Data	Equal	XX, 1

- b) Select the "ID type".
 c) Set the "Identifier" or an identifier range.
 d) Set the "DLC" or a DLC range.
 e) Set the "Data" or a data range.
8. For "Type" = "Error condition":
 a) Tap on "Set details".

Error Condition	Status
Form error	<input checked="" type="checkbox"/>
Bit stuffing error	<input checked="" type="checkbox"/>
Stuff count error	<input checked="" type="checkbox"/>
Ack error	<input checked="" type="checkbox"/>
Checksum error	<input checked="" type="checkbox"/>

b) Select one or more error conditions that you want to trigger on:

- "Form error"
- "Bit stuffing error"
- "Stuff count error"
- "Ack error"
- "Checksum error"

13.5.5.3 Exporting decode results

Once a decode has been completed, you can export the decode results of the

Prerequisites: A bus is configured for the CAN and decoded.

1. Tap on the "CAN" shortcut.
2. Tap on the "Shortcuts" tab.
3. Tap "Export results".
4. If necessary, enable "Include details".
5. If necessary, enable "Include timing".
6. Select the "File type".

An export file is saved in the selected directory.

The CAN export files contains the following fields:

- A list of all decoded frames:
 - Index
 - Start
 - Stop
 - State
 - Type
 - ID value
 - DLC
 - Nominal bit rate
 - Data bit rate
 - CRC
 - BRS
 - ESI
 - SBC
 - SDT
 - SEC
 - VCID
 - AF
 - PCRC

- The details frames include the following fields:
 - Index
 - Data

Example of CAN export file

```

Index,Start,Stop,State,Type, ID value,DLC,Nominal bit rate,Data bit rate,CRC,BRS,ESI,SBC,SDT,
SEC,VCID,AF,PCRC
1,-0.19,-0.188,'OK','XLFF',064h,7FFh,1000000,1000000,0000AABh,-,-,6h,FFh,1b,AAh,0000ABCDh,0
2,-0.188311,-0.188243,'OK','CBFF',064h,3h,1000000,1000000,35CEh,-,-,-,-,-,-,-,-
3,-0.188239,-0.188195,'OK','CBFR',064h,3h,1000000,1000000,5AA0h,-,-,-,-,-,-,-,-
4,-0.188191,-0.188157,'OK','FBFF',064h,2h,1000000,5000000,035FFh,0b,1b,Eh,-,-,-,-,-
5,-0.188153,-0.188075,'OK','CEFF',01401B26h,2h,1000000,1000000,32A0h,-,-,-,-,-,-,-
6,-0.188071,-0.188008,'OK','CEFR',01900064h,3h,1000000,1000000,32AAh,-,-,-,-,-,-,-
7,-0.188004,-0.187951,'OK','FEFF',01900064h,3h,1000000,5000000,032AAh,1b,0b,Fh,-,-,-,-,-
8,-0.187947,-0.187899,'OK','XLFF',064h,046h,1000000,1000000,000032AAh,-,-,6h,03h,0b,0Ah,0000
9,-0.187895,-0.187881,'INC','ERR',---,---,1000000,1000000,-,-,-,-,-,-,-,-
10,-0.187877,-0.187863,'UNKN','OVER',---,---,1000000,1000000,-,-,-,-,-,-,-,-

```

Details frame 2

```

Index,Data
1,D0h
2,E7h
3,20h

```

Details frame 4

```

Index,Data
1,D1h
2,E8h

```

Details frame 5

```

Index,Data
1,D2h
2,E9h

```

Details frame 7

```

Index,Data
1,D3h
2,EAh
3,21h

```

13.6 LIN (option R&S MXO5-K520)

The Local Interconnect Network (LIN) is a simple, low-cost bus system used within automotive network architectures. LIN is usually a subnetwork of a CAN bus. The primary purpose of LIN is the integration of uncritical sensors and actuators with low-

bandwidth requirements. Common applications in a motor vehicle are the control of doors, windows, wing mirrors, and wipers.

Required options and equipment

For performing LIN decode measurements, you need the following equipment:

- R&S MXO 5 with 1 available channel. The channel can be:
 - Analog channels (C1-C4)
 - Logic channels (D0-D15) (requires option R&S MXO5-B1)
- One probe
- Option R&S MXO5-K520

13.6.1 LIN configuration

13.6.1.1 LIN configuration settings

Access: [Apps] key > "Protocol" tab > "LIN" > "Setup".

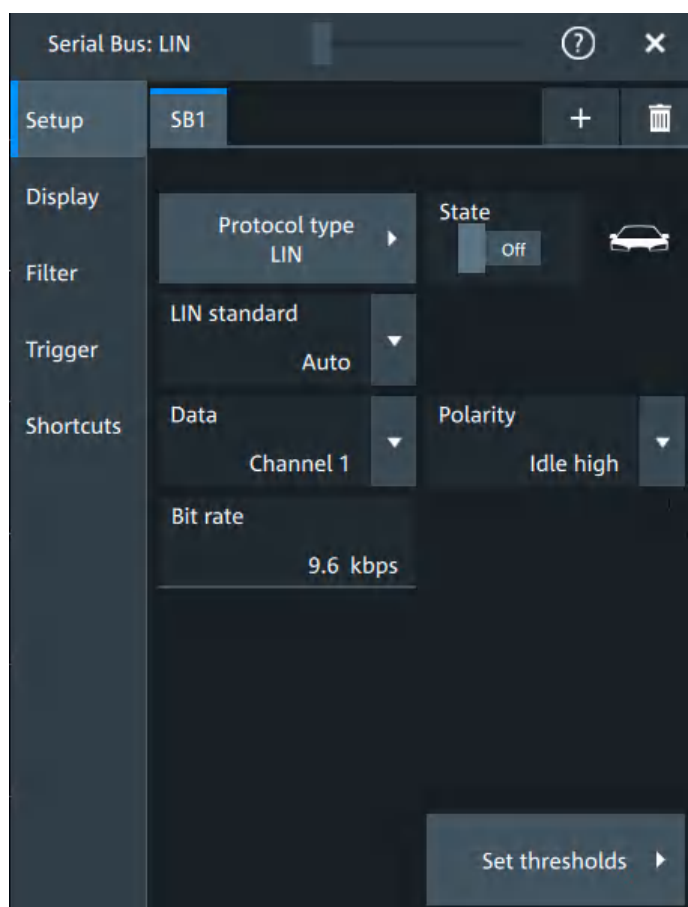

LIN standard

Selects the version of the LIN standard that is used in the DUT. The setting mainly defines the checksum version used during decoding.

The most common version is LIN v.2.x. For mixed networks, or if the standard is unknown, set the LIN standard to "Auto".

Remote command:

[SBUS<sb>:LIN:STANdard](#) on page 735

Data

Sets the source waveform of the data line.

Remote command:

[SBUS<sb>:LIN:DATA:SOURce](#) on page 734

Polarity

Defines the idle state of the bus. The idle state is the recessive state and corresponds to a logic high.

Remote command:

[SBUS<sb>:LIN:POLarity](#) on page 734

Bit rate

Sets the number of transmitted bits per second. The maximum bit rate for LIN is 20 kbit/s.

If the [LIN standard](#) is "J2602", the bit rate is 10.417 kbit/s and cannot be changed.

Remote command:

[SBUS<sb>:LIN:BITRate](#) on page 733

Threshold

Press "Set thresholds", to open the "Threshold setup" dialog.

Enter the value directly in the field of the threshold setup dialog.

Additional to the threshold, you can also set a hysteresis.

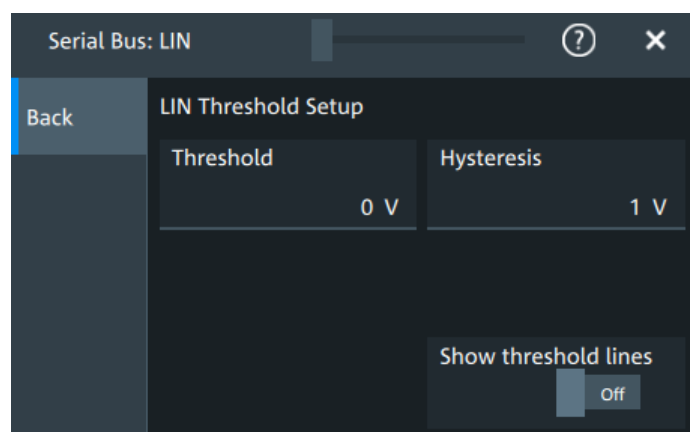

Remote command:

[SBUS<sb>:LIN:DATA:THReshold](#) on page 734

[SBUS<sb>:LIN:DATA:HYSTeresis](#) on page 734

Show threshold lines ← Threshold

If enabled, the threshold lines are displayed in the diagram.

The label of the threshold line is set according to the signal that it is referring to.

Remote command:

`SBUS<m>:THReshold` on page 646

13.6.1.2 Display settings

For details about the display settings, see [Chapter 13.1.3, "Display"](#), on page 288.

13.6.1.3 Shortcuts

For details about the available shortcuts, see [Chapter 13.1.6, "Shortcuts"](#), on page 290.

13.6.2 LIN trigger settings

Access: [Apps] > "Protocol" > "LIN" > "Shortcuts" > "Setup trigger".

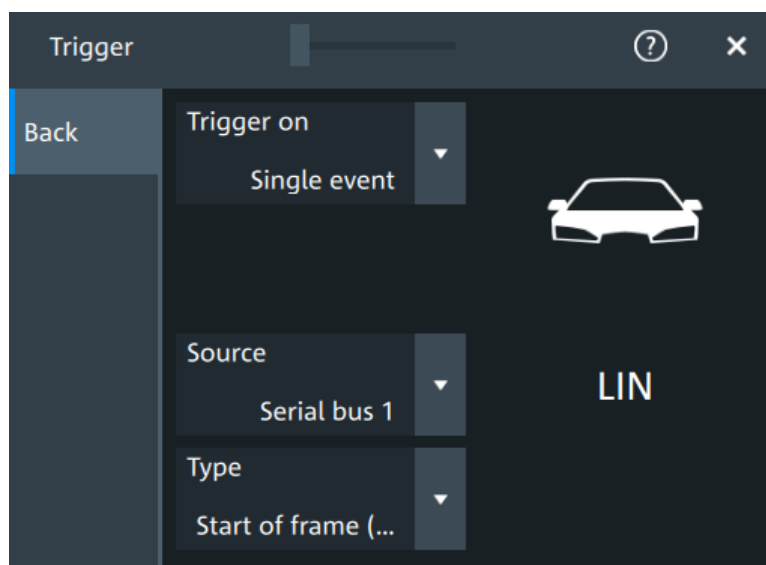
**Type**

Selects the trigger type for LIN analysis.

Some trigger types have additional settings that can be defined. In this case, the "Set details" button appears next to "Type" the function. Open it for a detailed definition of the trigger conditions.

"Start of frame Triggers on the stop bit of the sync field.
(Sync)"

"Identifier" Sets the trigger to one specific identifier or an identifier range. Enter only the 6-bit identifier without parity bits, not the protected identifier. Description of trigger type specific settings: [Identifier setup: Condition, Frame ID min, Frame ID max](#).

Back	Identifier	Frame ID min	Frame ID max
	In range	00	00

"Identifier + Data" Sets the trigger to a combination of identifier and data condition. The instrument triggers at the end of the last byte of the specified data pattern.

Back	Identifier	Frame ID min	Frame ID max
	In range	00	00
	Data	Pattern	Position
	Greater than	00	1

The identifier conditions are the same as for the "Identifier" trigger type, see [Identifier setup: Condition, Frame ID min, Frame ID max](#). Data conditions are set with [Data setup: Condition, Pattern, Position](#).

"Wake-up frame" Triggers after a wake-up frame.

"Error condition" Identifies various errors in the frame, see [Error conditions](#).

Remote command:

[TRIGger:LIN:TYPE](#) on page 736

Identifier setup: Condition, Frame ID min, Frame ID max

The identifier setup consists of the condition and one or two identifier pattern.

Condition Sets the comparison condition to a specific value or a range.

"Frame ID min" Defines the bit pattern of the identifier. Enter only the 6-bit identifier without parity bits, not the protected identifier.

"Frame ID max" Sets the maximum value of a range for "Condition" = "In range"/"Out of range".

Remote command:

[TRIGger:LIN:IMIN](#) on page 738

[TRIGger:LIN:IMAX](#) on page 738

[TRIGger:LIN:ICONdition](#) on page 737

Data setup: Condition, Pattern, Position

The data setup consists of the transfer direction, the number of bytes, the condition, and one data pattern.

Condition	Sets the operator to define a specific data pattern ("Equal" or "Not equal") or a range smaller or bigger than a specific pattern.
"Pattern"	Defines the data pattern.
"Position"	Sets the number of data events that are ignored, before trigger condition check of the data starts.

Remote command:

[TRIGger:LIN:DCONdition](#) on page 737

[TRIGger:LIN:DMIN](#) on page 737

[TRIGger:LIN:DPOSition](#) on page 737

Error conditions

Triggers if one or more of the following errors occur.

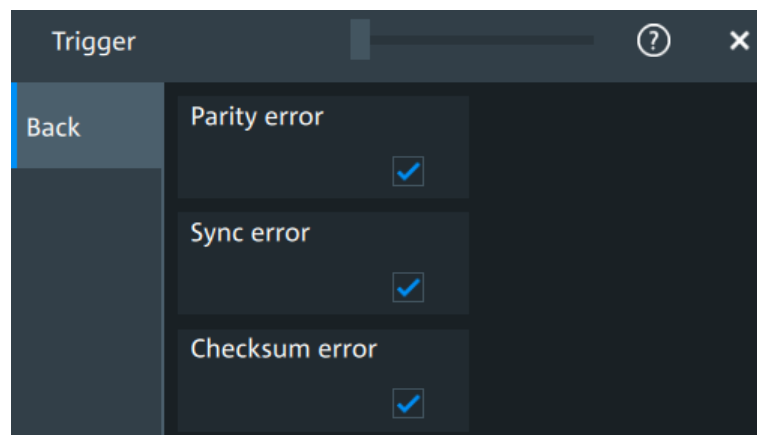

"Parity error"	Parity bits are the bits 6 and 7 of the identifier. They verify the correct transmission of the identifier.
"Sync error"	Synchronization error.
"Checksum error"	The checksum verifies the correct data transmission. It is the last byte of the frame response. The checksum includes not only the data but also the protected identifier (PID).

Remote command:

[TRIGger:LIN:IPERror](#) on page 738

[TRIGger:LIN:SYERror](#) on page 738

[TRIGger:LIN:CHKSeerror](#) on page 736

13.6.3 LIN filter

Access: [Apps] key > "Protocol" tab > "LIN" > "Filter" tab

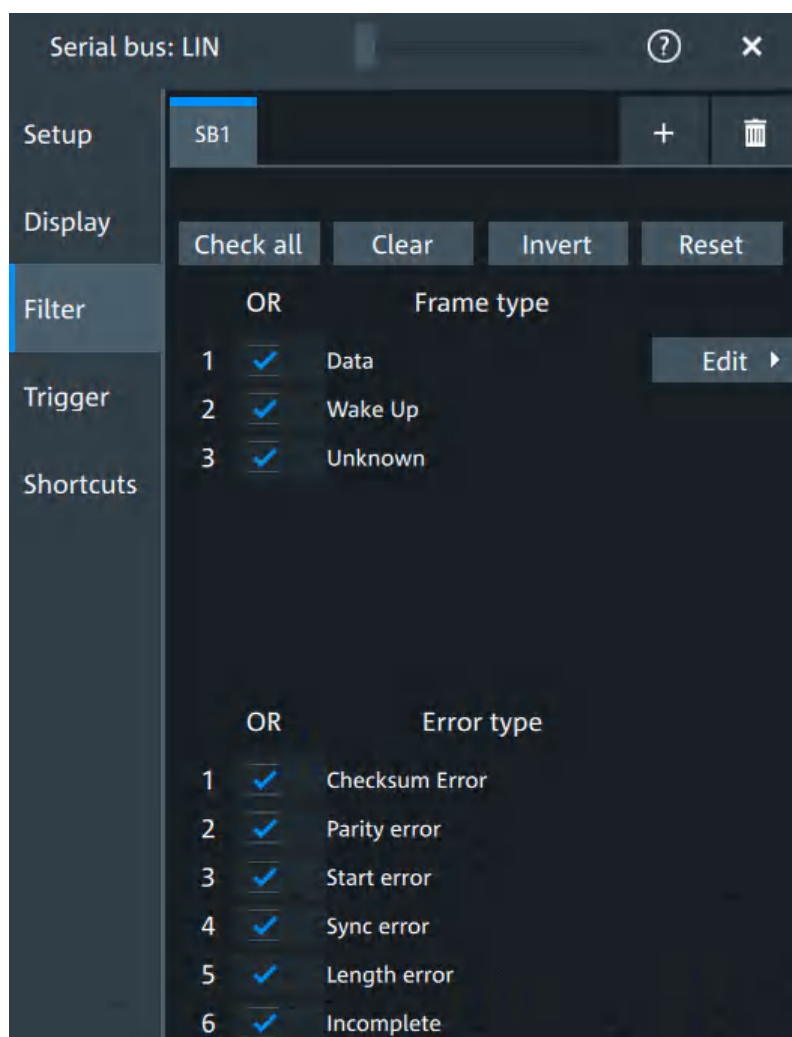

In the "Filter" tab, you can define the settings to display only the frames that match the selected filter conditions.

Check all, Clear, Invert, Reset

The following settings help you select the frames and errors you want to filter for. Only the frames and error types that match the selected filter conditions are displayed.

- "Check all" Enables the filter for all available frames and error types.
- "Clear" Disables the filter for all available frames and error types.
- "Invert" Inverts the current state of the frame and error types: all frames and error types that were enabled are disabled and vice versa.
- "Reset" Resets the state of the selected frames and error types.

Frame type

Selects the frame type that you want to display. You can filter all enabled frame types simultaneously.

For each frame type, you can also specify conditions for the value of the fields in the "Edit" dialog.

Available frames are "Data", "Wake" and "Unknown".

Remote command:

[SBUS<sb>:LIN:FILTer:FREnable on page 742](#)

[SBUS<sb>:LIN:FILTer:FRAME<fr>:ENABLE on page 742](#)

Edit

Opens a dialog to define the details of the selected frame.

"Field" Enables the field type that you want to filter on for the selected frame.

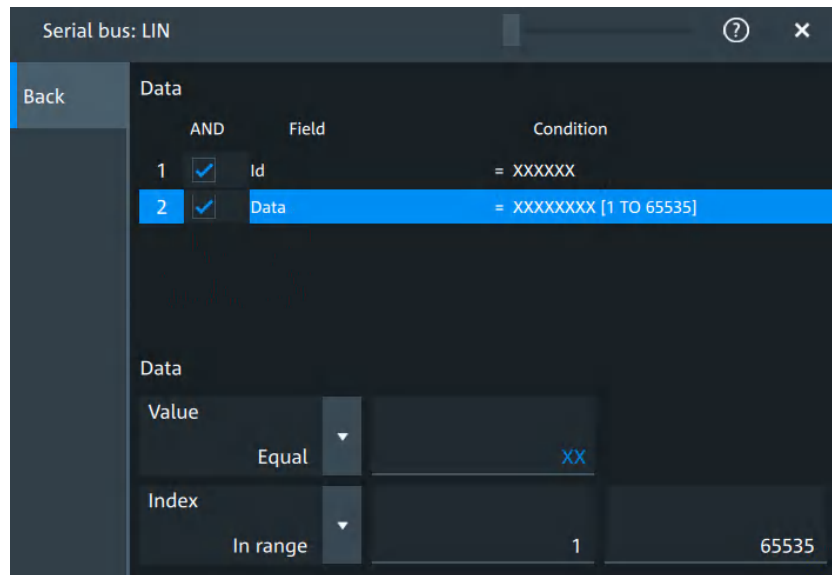

The available fields are "Id" and "Data".

Remote command:

[SBUS<sb>:LIN:FILTer:FIENable on page 741](#)

[SBUS<sb>:LIN:FILTer:FRAME<fr>:FLD<fl>:ENABLE on page 741](#)

"Condition" Displays the value condition for the selected field.

Remote command:

[SBUS<sb>:LIN:FILTer:BIT on page 739](#)

[SBUS<sb>:LIN:FILTer:FRAME<fr>:FLD<fl>:BIT on page 739](#)

"Data" The data setup consists of a comparison condition and one or two data patterns.

Remote command:

[SBUS<sb>:LIN:FILTer:DMAX on page 740](#)

[SBUS<sb>:LIN:FILTer:FRAME<fr>:FLD<fl>:DMAX on page 740](#)

[SBUS<sb>:LIN:FILTer:DMIN on page 740](#)

[SBUS<sb>:LIN:FILTer:FRAME<fr>:FLD<fl>:DMIN on page 740](#)

[SBUS<sb>:LIN:FILTer:DOPerator on page 740](#)

[SBUS<sb>:LIN:FILTer:FRAME<fr>:FLD<fl>:DOPerator on page 740](#)

"Index" The index setup consists of a comparison condition and one or two index values.

Remote command:

[SBUS<sb>:LIN:FILTer:IMAX](#) on page 742

[SBUS<sb>:LIN:FILTer:FRAMe<fr>:FLD<fl>:IMAX](#)
on page 742

[SBUS<sb>:LIN:FILTer:IMIN](#) on page 742

[SBUS<sb>:LIN:FILTer:FRAMe<fr>:FLD<fl>:IMIN](#)
on page 742

[SBUS<sb>:LIN:FILTer:IOPerator](#) on page 743

[SBUS<sb>:LIN:FILTer:FRAMe<fr>:FLD<fl>:IOPerator](#)
on page 743

Error type

Enables filtering on the selected error type.

The available errors are "Checksum error", "Parity error", "Start error", "Sync error", "Length error" and "Incomplete".

Remote command:

[SBUS<sb>:LIN:FILTer:ERENable](#) on page 741

[SBUS<sb>:LIN:FILTer:ERRor<n>:ENABLE](#) on page 741

13.6.4 LIN decode results

When the configuration of the serial bus is complete, the signal can be decoded:

1. Open the "Serial Bus" dialog for the respective bus.
2. In the "Setup" tab, enable "State".
3. In the "Display" tab, enable "Show decode table".

For a description of the display settings, see also [Chapter 13.1.3, "Display"](#), on page 288.

The instrument captures and decodes the signal according to the standard definition and the configuration settings.

The color-coding of the various protocol sections and errors simplifies the interpretation of the visual display. The decode information condenses or expands, depending on the horizontal scale. Various data formats are available to show the result values.

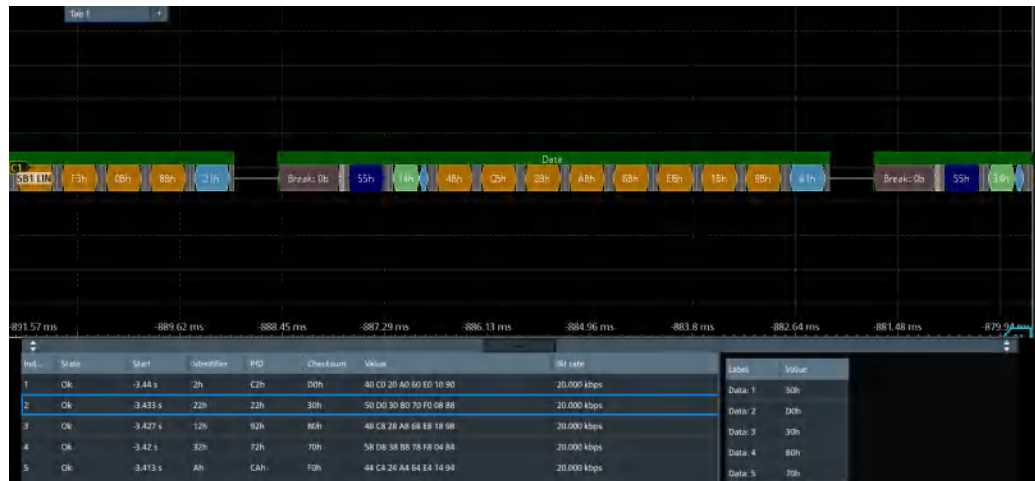

Table 13-9: Content of the Decode results table

Column	Description
Index	Index of the decoded frame
State	Overall state of the frame
Start	Time of frame start
Identifier	Identifier value
PID	Protected identifier
Checksum	Checksum value
Values	Value of the data bytes. The data format is selected below the table.
Bit rate	Value of the bit rate

Table 13-10: Content of the Details frame table

Column	Description
Label	State of the field
Value	Value of the field

Data format

You can select various data formats for the values displayed in the decode table and in the combs of the decoded signal.

Remote command:

- `SBUS<sb>:FORMat` on page 645

Export of decode results

1. In the protocol "Shortcuts" tab, press "Export results".

The "Export results" dialog opens.

For details, see [Chapter 13.1.7, "Export protocol results"](#), on page 291.

2. Select the details that you want to export and the file format.
3. Tap "Save as".
4. Key in a name and select the file format.

Remote commands

Remote commands to retrieve decode results are described in [Chapter 17.16.6, "LIN \(option R&S MXO5-K520\)"](#), on page 733.

13.6.5 Performing LIN decoding

This chapter explains step by step how to configure and decode the LIN bus.

13.6.5.1 Configuring LIN signals

For configuration, assign the lines to the input channels, and define the active states and the logical thresholds.

For details on configuration settings, see [Chapter 13.6.1, "LIN configuration"](#), on page 366.

1. Tap the "Bus" activator in the bottom right of the screen.

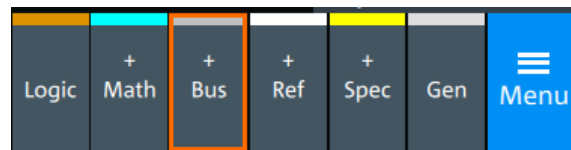

2. Select the tab of the bus that you want to set up, for example "SB1".
3. Tap the "Protocol type" button. Select the protocol: LIN.
4. Tap on "State" to enable the decoding.

An SPI shortcut appears at the bottom left of the screen. Tap on the shortcut for a quick access to the "LIN" dialog settings.

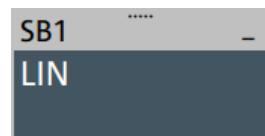

5. Select the "LIN standard".
6. Select the correct channel for "Data".
7. Set the "Bit rate".
8. Check that the signals are on the screen.
If not try adjusting the vertical and horizontal settings.
9. Set the logical thresholds:

- a) Tap "Threshold setup". The threshold dialog opens.
- b) For each wire, set the threshold value. A typical value is 3.5 V.
- c) If necessary, set the hysteresis value.
- d) Optionally, tap on "Show threshold lines".

13.6.5.2 Triggering on LIN

Prerequisites: A bus is configured for the LIN signal to be analyzed. See [Chapter 13.6.5.1, "Configuring LIN signals"](#), on page 375.

1. Open "Menu" > "Trigger".
2. Set "Trigger on" to "Single event".
3. Ensure that the "Source" is set to the configured serial bus, e.g. "Serial bus 1".
4. Select the "Type".
5. Define additional settings for more complex trigger types: "Identifier", "Identifier +Data".
 - a) Tap on "Set details".
 - b) Set the "Identifier" condition or an identifier range.
 - c) Set the "Data" condition or a data range.

13.6.5.3 Exporting decode results

Once a decode has been completed, you can export the decode results of the

Prerequisites: A bus is configured for the LIN and decoded.

1. Tap on the "LIN" shortcut.
2. Tap on the "Shortcuts" tab.
3. Tap "Export results".
4. If necessary, enable "Include details".
5. If necessary, enable "Include timing".
6. Select the "File type".

An export file is saved in the selected directory.

The LIN export file contains the following fields:

- A list of all decoded frames:
 - Index
 - Start
 - Stop
 - State
 - Identifier

- PID
- Checksum
- Bit rate
- The details frames include the following fields:
 - Index
 - State
 - Value

Example of LIN export file

```
Index,Start,Stop,State,Identifier,PID,Checksum,Bit rate
1,-3.44,-3.43375,'OK',02h,C2h,D0h,20000
2,-3.43325,-3.427,'OK',22h,22h,30h,20000
3,-3.4265,-3.42025,'OK',12h,92h,B0h,20000
4,-3.41975,-3.4135,'OK',32h,72h,70h,20000
5,-3.413,-3.40675,'OK',0Ah,CAh,F0h,20000
```

```
Details frame 1
Index,State,Value
1,'OK',40h
2,'OK',C0h
3,'OK',20h
4,'OK',A0h
5,'OK',60h
6,'OK',E0h
7,'OK',10h
8,'OK',90h
```

```
Details frame 2
Index,State,Value
1,'OK',50h
2,'OK',D0h
3,'OK',30h
4,'OK',B0h
5,'OK',70h
6,'OK',F0h
7,'OK',08h
8,'OK',88h
```

14 Mixed signal option (MSO, R&S MXO5-B1)

The Mixed Signal Option R&S MXO5-B1 adds logic analyzer functions to the classical oscilloscope functions. Using the MSO option, you can analyze and debug embedded systems with mixed-signal designs that use analog signals and correlated digital signals simultaneously.

The Mixed Signal Option provides 16 digital channels grouped in two logic probes (pods) with 8 channels each. The instrument ensures that analog and digital waveforms are time-aligned and synchronized so that critical timing interactions between analog and digital signals can be displayed and tested. The automatic alignment compensates the skew between the probe connectors of the analog channels and the probe boxes of the digital channels.

14.1 Logic configuration

Access: "Menu" > "Logic" > "Setup" tab

Digital channels can be displayed individually, and they can be grouped and displayed as a logic group. You can configure and enable up to 4 logic groups. Each digital channel can be assigned to one *active* logic only, the instrument disables conflicting buses automatically.

For clocked buses, you can display the decoded data in a result box.



If you have configured several logic groups and you want to modify the settings, make sure that the tab of the correct logic is selected. Disable the logic before you change the settings.

14.1.1 Setup

Access: "Menu" > "Logic" > "Setup" tab

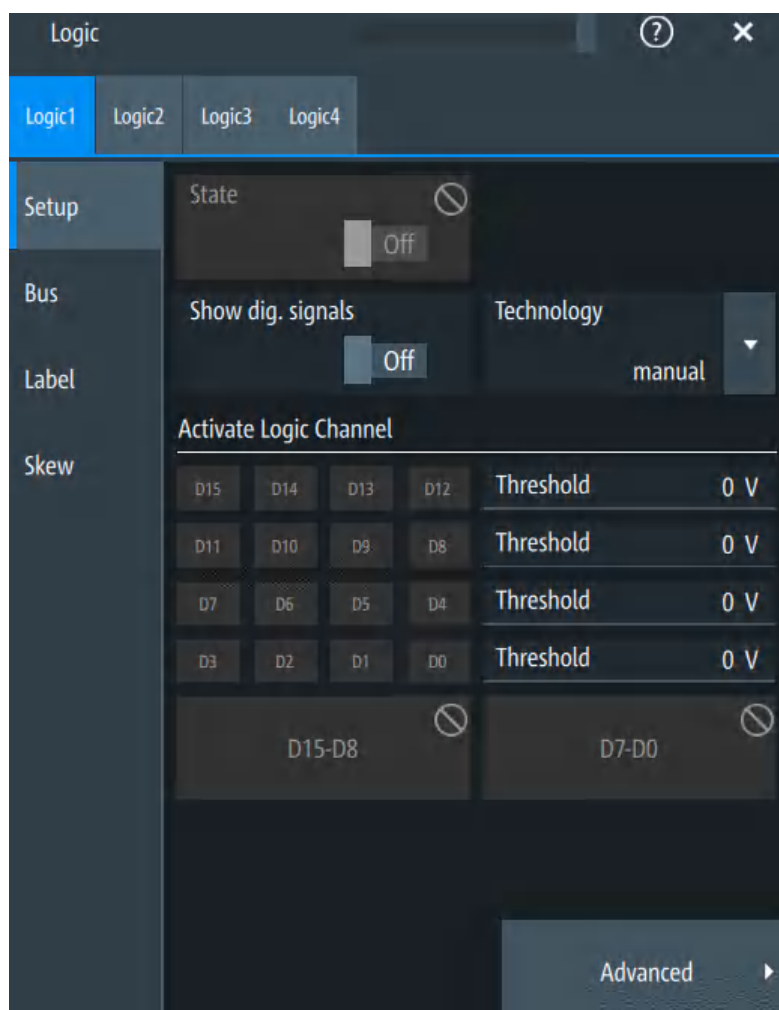
**State**

Enables the selected logic group. The corresponding signal icon appears on the signal bar.

If another active bus already uses the same digital channel, the instrument disables the other bus and shows a message.

Remote command:

[PBUS<pb>:STATe](#) on page 757

Show dig. signals

If enabled, the selected digital channels are shown in the diagram. Each channel is displayed as a logic signal.

Remote command:

[PBUS<pb>:DISPlay:SHDI](#) on page 755

Technology,Threshold

Sets the logical threshold. For each sample, the instrument compares the input voltage with the threshold value. If the input voltage is above the threshold, the signal state "1" is stored. Otherwise, the signal state "0" is stored if the input voltage is below the threshold.

To avoid the change of signal states due to noise, a hysteresis is considered.

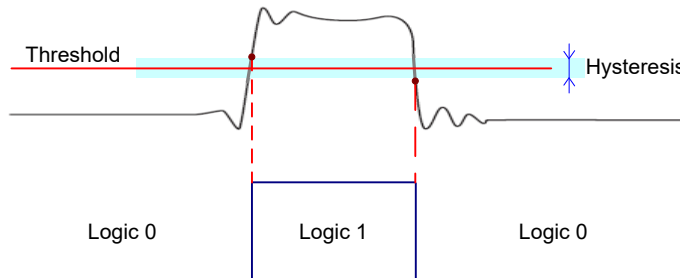

By default, same threshold and hysteresis value are used for all digital channels and all logic buses: "Couple thresholds" is enabled.

You can also set different thresholds for the individual channel groups. As long as the buses are disabled, you can set different thresholds for each bus. Active buses use the same threshold and hysteresis values, the settings of the last activated bus take effect.

The range of threshold levels and the minimum voltage swing is given in the data sheet.

"Threshold" Enter the value directly in the field.

"Technology" Selects the threshold voltage for various types of integrated circuits from a list and applies it to all digital channels. The value is set to "Manual" if a user-defined threshold was entered directly.

Remote command:

[PBUS<pb>:TECHnology](#) on page 757

[PBUS<pb>:THReshold<n>](#) on page 758

Advanced

Opens a dialog for advanced threshold and hysteresis settings. You can define them additional to the "Threshold" and "Technology".

Level coupling ← Advanced

Sets the threshold and the hysteresis for all digital channels and all buses to the same value.

Remote command:

[PBUS<pb>:THCoupling](#) on page 758

Hysteresis ← Advanced

Defines the size of the hysteresis for the respective channels.

"Normal" The instrument sets a small value suitable for the signal and its settings. Use this setting for clean signals.

"Maximum" The instrument sets the maximum value that is possible and useful for the signal and its settings. Use this setting for noisy signals.

"Robust" Sets different hysteresis values for falling and rising edges to avoid an undefined state of the trigger system. Use this setting for very noisy signals.

Remote command:

[PBUS<pb>:HYSTeresis<n>](#) on page 756

Active logic channel

Selects the state of the respective bus channel.

Enable/Disable D7-D0,D15-D8

The buttons select or deselect all digital channels of a pod at once.

14.1.2 Bus

Access: "Menu" > "Logic" > "Bus" tab

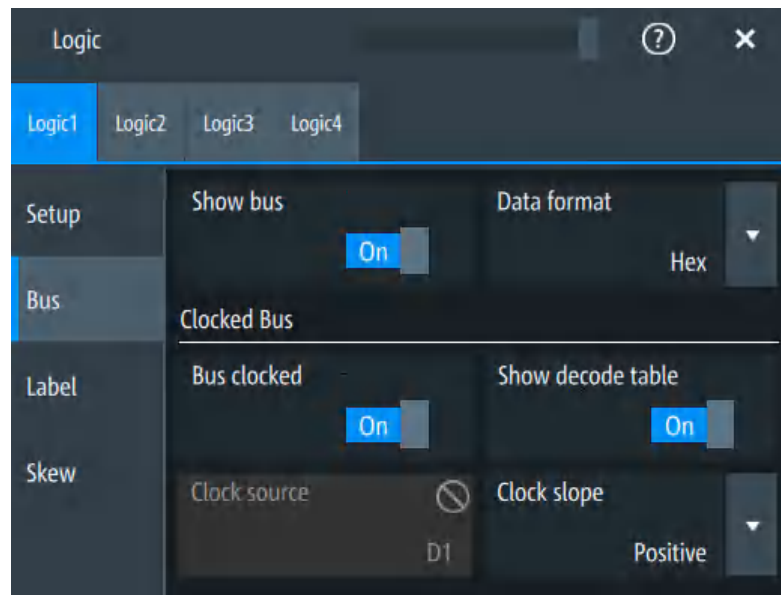

Show bus

If enabled, the resulting bus signal and bus values are displayed in the diagram.

Remote command:

[PBUS<pb>:DISPlay:SHBU](#) on page 755

Data format

Sets the data format of bus values, which are displayed in the decode table and on the comb bus display.

Available formats are: Hex, octal, binary, ASCII, string, signed, unsigned, symbolic, and auto.

Signed and Unsigned are integer data types with maximum 16-bit length. Unsigned is used for positive integers. Signed is used for positive and negative integers.

If the target file format is BIN, you can save only signed and unsigned binary data. The data format "Signed" writes signed data; all other formats are saved as unsigned binary data.

Remote command:

[PBUS<pb>:DATA:FORMat](#) on page 760

[PBUS<pb>:DATA:HEADer?](#) on page 760

[PBUS<pb>:DATA\[:VALues\]?](#) on page 761

Clocked bus

If a bus is a clocked bus, one of the digital channels serves as clock of the bus.

For an unclocked bus, the logical state of the bus is determined for each sample. For a clocked bus, the logical state is determined only at the specified clock edges.

Bus clocked ← Clocked bus

Enable this option for a clocked bus.

Remote command:

[PBUS<pb>:CLON](#) on page 754

Show decode table ← Clocked bus

If enabled, a results box opens with decoded values of the bus signal and its time. Each clock edge corresponds to one row in the table.

The decode table is only available for clocked buses to check the data words.

Clock source ← Clocked bus

Selects the digital channel used as clock.

Remote command:

[PBUS<pb>:CLOCK](#) on page 753

Clock slope ← Clocked bus

Selects the slope of the clock signal at which all digital channels of the bus are analyzed.

Remote command:

[PBUS<pb>:CLSLope](#) on page 754

14.1.3 Label settings

Access: "Menu" > "Logic" > "Label" tab

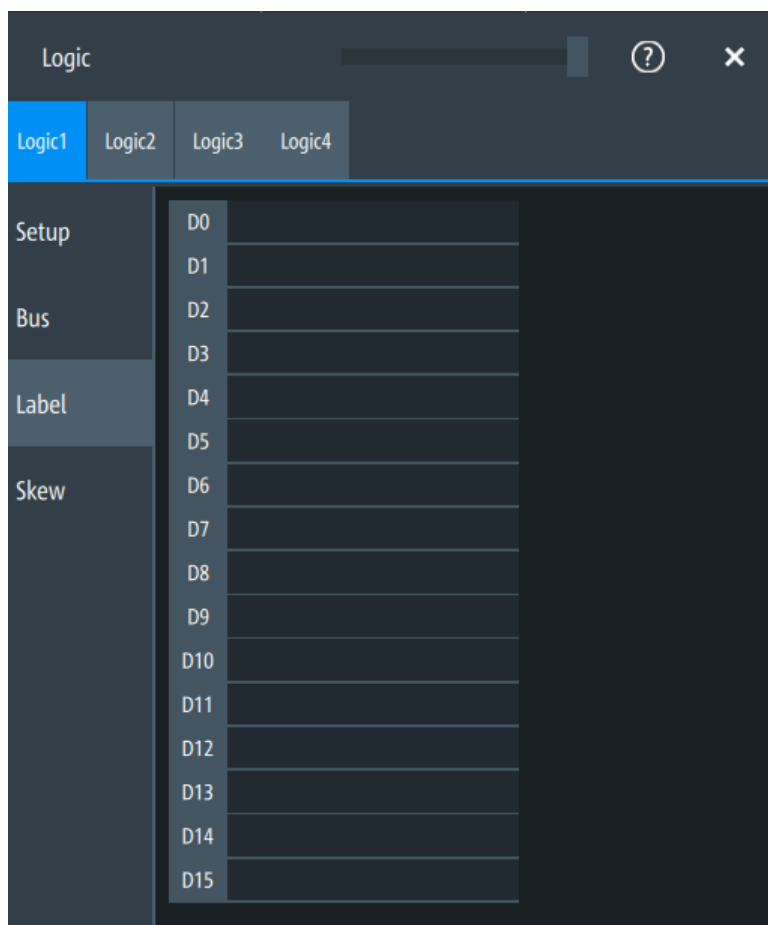

In this tab, you can enter a name for each digital channel. The name is displayed in the diagram.

[PBUS<pb>:BIT<n>:LAbel](#) on page 752

14.1.4 Skew settings

Access: "Menu" > "Logic" > "Skew" tab

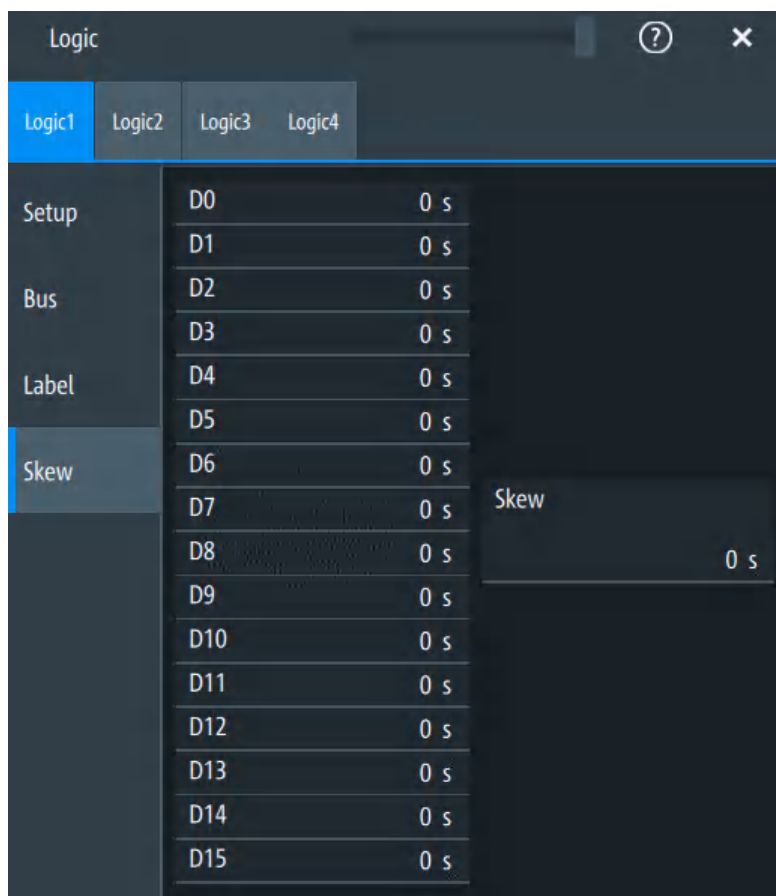
**D0-D15**

Sets an individual delay for each digital channel to time-align it with other digital channels.

The skew value compensates delays that are known from the circuit specifics or caused by the different length of cables. The skew between the probe boxes of the digital channels and the probe connectors of the analog channels is automatically aligned by the instrument.

Remote command:

[PBUS<pb>:BIT<n>:SKEW](#) on page 752

Skew

Sets a general delay for all digital channels.

Remote command:

[PBUS<pb>:SKEW](#) on page 757

14.2 Display

Each logic group is shown in a separate diagram, and the diagrams can be minimized and arranged as usual.

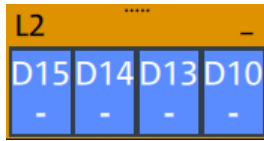

You can adjust the display of the logic bus signals and the individual digital channels to optimize the analysis of bus data:

- Show the digital channels which are assigned to the bus, drag them to the optimal position, and scale them.
- Adjust size and position of the logic signal: Therefore, tap the Lx signal or the signal icon, and use the [Position] and [Scale] knobs.
- Adjust size and position of all active digital channels: Therefore, tap one of the Dx signals, and use the [Position] and [Scale] knobs.
- Show the result table of the decoded clocked bus signal.

Remote commands:

- [PBUS<pb>:DIGSignals:POSition](#) on page 754
- [PBUS<pb>:DIGSignals:SCALE](#) on page 755
- [PBUS<pb>:POSition](#) on page 756
- [PBUS<pb>:SCALE](#) on page 756

To access and analyze one or more specific acquisitions, you can use the "History" in the common way.

Furthermore, you can zoom in digital signals and bus signal in the same way as in analog waveforms.

14.2.1 Logic bus - decode table

Decoding is available for clocked buses.

The decode table shows the decoded data words of the bus signal and the corresponding time. Each clock edge corresponds to one row in the table. Beside the table, you can select the data format of the bus values.

Result	Time	Value	Data format
			Binary

The results can be saved to a `.csv` or `.html` file.

15 Waveform generator (option R&S MXO5-B6)

The R&S MXO 5 includes a two-channel 100 MHz waveform generator which can generate a wide range of waveform and modulation types.

With each of the waveform generators, one can output simple functions, modulated sine waveform, arbitrary waveforms and sweep waveforms. It is possible to couple and synchronize the settings of the waveform generators.

The instrument preset does not affect the generator settings. Each generator has its own preset ("Default setup"). When the instrument is shut down, the waveform generator settings are stored. At instrument start, these settings are restored but the generators are switched off. When a saveset of instrument settings is recalled, generators are also switched off but the generator settings remain unchanged.

15.1 Setup of the waveform generator

Access: "Gen" signal activator > "Gen"1 or "Gen"2 > "Setup" tab.

15.1.1 General settings

The "Setup" tab provides general settings like enabling the waveform generator, and setting that depend on the selected function type.

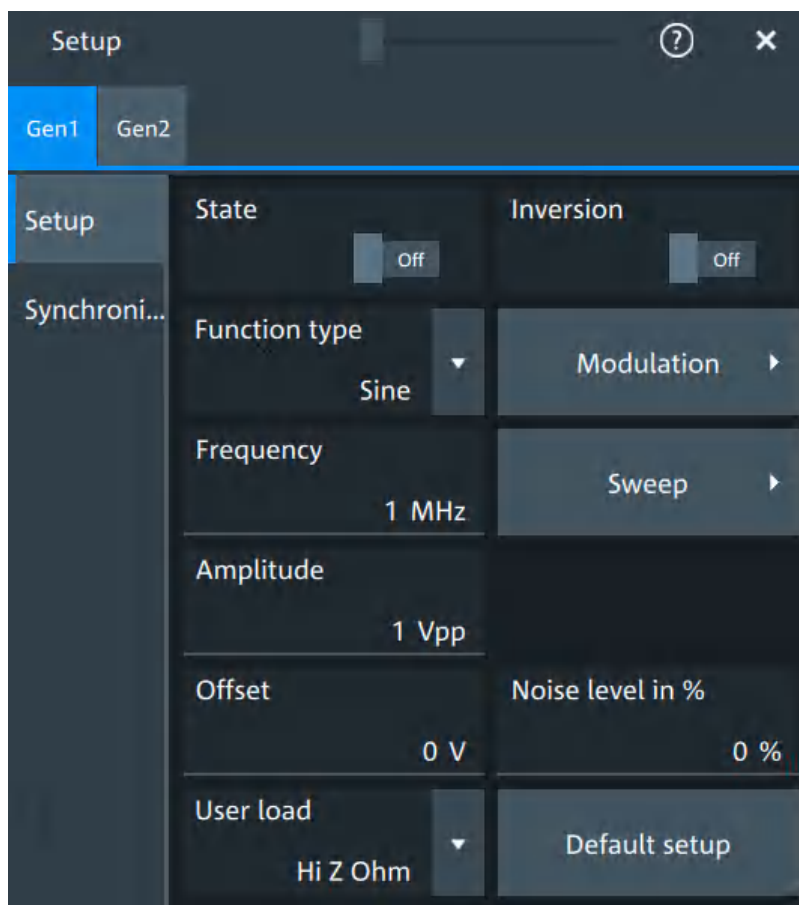
**State**

Enables the function generator.

Remote command:

[WGENerator<wg>\[:ENABLE\]](#) on page 766

Inversion

Inverts the waveform at the offset level.

Remote command:

[WGENerator<wg>:VOLTage:INVersion](#) on page 765

Function type

Selects the type of waveform to be generated.

For all waveforms, you can set:

- [Frequency](#)
- [Amplitude](#)
- [Offset](#)

"Sine" Generates a sine wave.

Function type Sine	Modulation
Frequency 1 MHz	Sweep
Amplitude 1 Vpp	
Offset 0 V	Noise level in % 0 %

"Square" Generates a square wave.

Function type Square	Modulation
Frequency 10 MHz	Duty cycle 50 %
Amplitude 200 mVpp	
Offset 0 V	Noise level in % 0 %

"Ramp" Generates a ramp signal. You can set the [Symmetry](#).

Function type Ramp	
Frequency 1 MHz	Symmetry 50 %
Amplitude 200 mVpp	
Offset 0 V	Noise level in % 0 %

"DC"

Generates a direct current (DC) signal.

State	Off
Function type	DC
DC level	0 V
Noise level for DC	0 Vpp

"Pulse"

Generates a pulse signal. Additional settings are the [Pulse width](#).

Function type	Pulse	Modulation	▶
Frequency	10 MHz	Period	1 μ s
Amplitude	200 mVpp	Pulse width	83.5 ns
Offset	0 V	Noise level in %	0 %

"Cardinal sine" Generates a cardinal sine wave.

Function type	▼
Cardinal sine	
Frequency	
5 MHz	
Amplitude	
200 mVpp	
Offset	Noise level in %
0 V	0 %

"Cardiac" Generates a cardiac signal.

Function type	▼
Cardiac	
Frequency	
1 MHz	
Amplitude	
200 mVpp	
Offset	Noise level in %
0 V	0 %

"Gauss" Generates a Gaussian signal.

Function type	▼
Gauss	
Frequency	
10 MHz	
Amplitude	
200 mVpp	
Offset	Noise level in %
0 V	0 %

"Lorentz" Generates a Lorentz signal .

Function type	▼
Lorentz	
Frequency	
10 MHz	
Amplitude	
200 mVpp	
Offset	Noise level in %
0 V	0 %

"Exp. rise" Generates an exponential rise signal.

Function type	▼
Exp. rise	
Frequency	
10 MHz	
Amplitude	
200 mVpp	
Offset	Noise level in %
0 V	0 %

"Exp. fall" Generates an exponential fall signal.

Function type	▼
Exp. fall	
Frequency	
10 MHz	
Amplitude	
200 mVpp	
Offset	Noise level in %
0 V	0 %

"Arbitrary" Generates an arbitrary waveform, which is copied from an existing waveform, or loaded from file. See [Chapter 15.1.4, "Arbitrary waveforms"](#), on page 398.

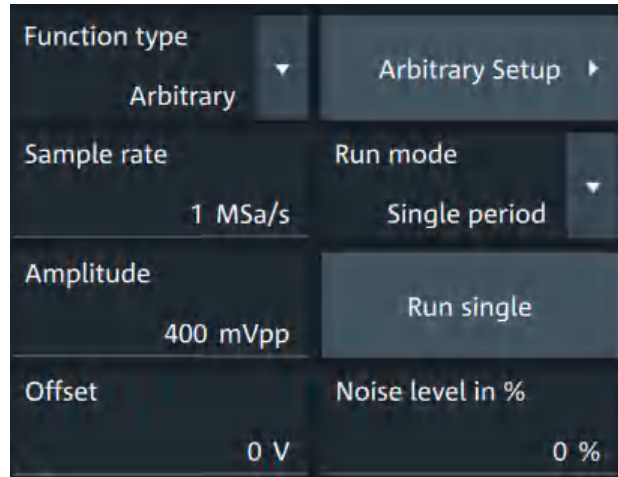

Remote command:

[WGEnerator<wg>:FUNCTION\[:SElect\]](#) on page 763

Frequency

Sets the frequency of the waveform.

The available frequency range depends on the selected "Function type", see [Frequency range of the function generator waveforms](#).

Table 15-1: Frequency range of the function generator waveforms

"Function type"	Min frequency	Max frequency
"Sine"	0.001 Hz	100 MHz
"Square"	0.001 Hz	30 MHz
"Ramp"	0.001 Hz	1 MHz
"DC"	-	-
"Pulse"	0.001 Hz	30 MHz
"Cardinal sine"	0.001 Hz	5 MHz
"Cardiac"	0.001 Hz	1 MHz
"Gauss"	0.001 Hz	25 MHz
"Lorentz"	0.001 Hz	10 MHz
"Exp. rise"	0.001 Hz	10 MHz
"Ep. fall"	0.001 Hz	10 MHz

Remote command:

[WGEnerator<wg>:FREQuency](#) on page 762

Amplitude

Sets the amplitude of the waveform.

Remote command:

[WGENerator<wg>:VOLTage\[:VPP\]](#) on page 766

Offset

Sets the vertical offset of the generated waveform.

Remote command:

[WGENerator<wg>:VOLTage:OFFSet](#) on page 766

Arbitrary Setup

Opens a menu to configure the arbitrary waveform.

See [Chapter 15.1.4, "Arbitrary waveforms"](#), on page 398.

Sweep

Opens a menu to configure the sweep.

See [Chapter 15.1.3, "Sweep settings"](#), on page 397.

Modulation

Opens a menu to configure the modulation.

See [Chapter 15.1.2, "Modulation settings"](#), on page 394.

Noise level in %

Sets the level of the noise in percentage of the set "Amplitude" output of the signal.

Remote command:

[WGENerator<wg>:MODulation:NLPCent](#) on page 773

User load

Select the user load, the load of the DUT at its connection.

You can select either a "50Ω" or a "High-Z" (high input impedance) load.

Remote command:

[WGENerator<wg>:OUTPut\[:LOAD\]](#) on page 764

Symmetry

Sets the symmetry of a ramp waveform, the percentage of time the waveform is rising. By changing the symmetry of the ramp, you can create, for example, triangular waveforms.

50% defines symmetric triangles. Values <50% define triangles with steeper rising edge leaned to the left. Values >50% define triangles with steeper falling edge leaned to the right.

Remote command:

[WGENerator<wg>:FUNCTion:RAMP\[:SYMMetry\]](#) on page 763

Duty cycle

Sets the duty cycle for the pulse function.

The duty cycle expresses for what percentage of the period, the signal state is high.

Remote command:

[WGENerator<wg>:FUNCTion\[:SQUare\]:DCYCLE](#) on page 763

Pulse width

Sets the pulse width, the pulse duration of the generated pulse waveform.

Remote command:

[WGENerator<wg>:FUNCTION:PULSe\[:WIDTh\]](#) on page 762

Default setup

Presets the generator to a default setup. The default includes the following settings:

- "Function type" = "Sine"
- "Frequency" = "1 MHz"
- "Amplitude" = "1 Vpp"

Remote command:

[WGENerator<wg>:PRESet](#) on page 764

DC level

Available for "Function type" = DC.

Sets the level for the DC signal.

Remote command:

[WGENerator<wg>:VOLTage:DCLevel](#) on page 765

Noise level for DC

Available for "Function type" = "DC".

Sets the level of the noise for the DC signal.

Remote command:

[WGENerator<wg>:MODulation:NDCLevel](#) on page 772

Period

Available for "Function type" = "Pulse".

Sets the period of the pulse waveform.

Remote command:

[WGENerator<wg>:PERiod](#) on page 764

15.1.2 Modulation settings

Modulation is available only for sine and square waveforms.

Access: "Gen" signal activator > "Gen"1 or "Gen"2 > "Setup" tab > "Function type" = "Sine" or "Square" > "Modulation".

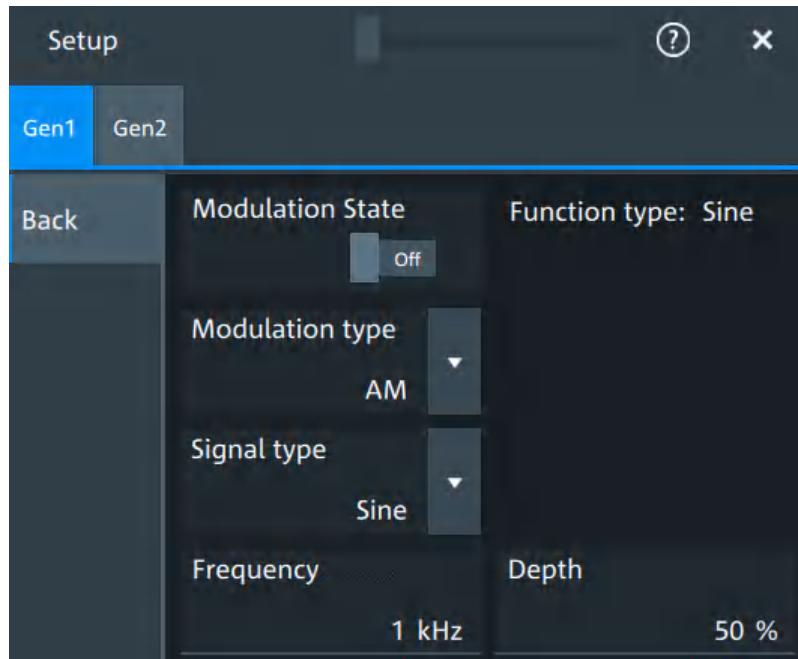
**Modulation state**

Enables or disables modulation.

Modulation is available only for "Function type" = "Sine"/"Square".

Remote command:

[WGENerator<wg>:MODulation\[:STATe\]](#) on page 767

Modulation type

Selects the modulation type, which defines how the carrier signal is modified.

"AM"	Amplitude modulation. The amplitude of the carrier signal is varied according to the modulation signal.
"FM"	Frequency modulation. The frequency of the carrier signal is varied according to the modulation signal.
"PWM"	Pulse width modulation. The time for which the signal is in a high state is varied according to the modulation signal.
"FSK"	Frequency shift keying (FSK) modulation. The signal frequency switches between "Frequency 1" and "Frequency 2" at a "FSK rate".

Remote command:

[WGENerator<wg>:MODulation:TYPE](#) on page 775

Signal type

Selects the type of the modulating signal for AM, FM or PWM modulation.

Remote command:

[WGENerator<wg>:MODulation:AM\[:FUNCTION\]](#) on page 769

[WGENerator<wg>:MODulation:FM\[:FUNCTION\]](#) on page 771

[WGENerator<wg>:MODulation:PWM\[:FUNCTION\]](#) on page 774

Frequency

Sets the frequency of the modulating waveform for AM/FM/PWM modulation.

Remote command:

[WGENerator<wg>:MODulation:AM:FREQuency](#) on page 768

[WGENerator<wg>:MODulation:FM:FREQuency](#) on page 770

[WGENerator<wg>:MODulation:PWM:FREQuency](#) on page 774

Depth

Sets the modulation depth, the percentage of the amplitude range that is used for AM modulation.

Remote command:

[WGENerator<wg>:MODulation:AM:DEPTh](#) on page 768

Duty cycle

Sets the duty cycle for a square waveform. The duty cycle expresses for what percentage fraction of the period, the waveform is active, i.e. the signal state is high.

Remote command:

[WGENerator<wg>:MODulation:AM:DCYCLe](#) on page 767

[WGENerator<wg>:MODulation:FM:DCYCLe](#) on page 770

[WGENerator<wg>:MODulation:PWM:DCYCLe](#) on page 773

Symmetry

Sets the symmetry for the ramp modulation waveform, the percentage of time that the waveform is rising.

Remote command:

[WGENerator<wg>:MODulation:AM:SYMMetry](#) on page 768

[WGENerator<wg>:MODulation:FM:SYMMetry](#) on page 771

[WGENerator<wg>:MODulation:PWM:SYMMetry](#) on page 774

Deviation

Sets the frequency deviation, the maximum difference between the FM modulated signal and the carrier signal.

Remote command:

[WGENerator<wg>:MODulation:FM:DEVIation](#) on page 770

Modulation depth

Sets the modulation depth, the percentage of the amplitude range that is used for PWM modulation.

Remote command:

[WGENerator<wg>:MODulation:PWM:DEPTh](#) on page 773

Frequency 1/Frequency 2

Sets the frequency of the first /second signal in FSK modulated signal.

Remote command:

[WGENerator<wg>:MODulation:FSK:FONE](#) on page 771

[WGENerator<wg>:MODulation:FSK:FTWO](#) on page 771

FSK rate

Sets the frequency at which signal switches between "Frequency 1" and "Frequency 2".

Remote command:

[WGENerator<wg>:MODulation:FSK\[:RATE\]](#) on page 772

15.1.3 Sweep settings

Sweep is available only for sine waveforms.

Access: "Gen" signal activator > "Gen1" or "Gen2" > "Setup" tab > "Function type" = "Sine" > "Sweep".

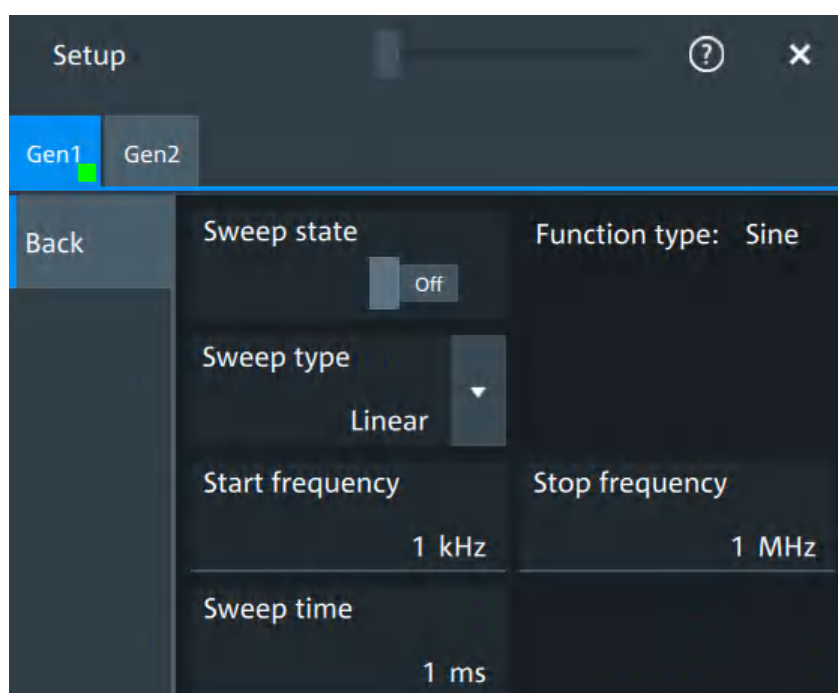

In the sweep mode, the R&S MXO 5 generates a signal whose frequency gradually changes from the "Start frequency" to the "Stop frequency" for a certain "Sweep time".

For a step-by-step description of the sweep setup, see [Chapter 15.3.3, "Configuring a sine sweep waveform"](#), on page 405.

Sweep state

Enables or disables the sweeping.

Remote command:

[WGENerator<wg>:SWEep\[:STATe\]](#) on page 777

Sweep type

Sets the type of the sweep, a linear or logarithmic change of the frequency.

Remote command:

[WGENerator<wg>:SWEep:TYPE](#) on page 778

Start frequency

Sets the start frequency of the sweep signal.

Remote command:

[WGENerator<wg>:SWEep:FStart](#) on page 778

Stop frequency

Sets the stop frequency of the sweep signal.

Remote command:

[WGENerator<wg>:SWEep:FEND](#) on page 778

Sweep time

Sets the duration of the sweep.

Remote command:

[WGENerator<wg>:SWEep:TIME](#) on page 778

15.1.4 Arbitrary waveforms

The arbitrary waveform generator allows you to output a user-defined waveform for testing your devices. An arbitrary waveform is copied from an existing waveform on the instrument, or loaded from file. You can load CSV files that follow a defined structure, or saved reference waveforms.

See also: [Chapter 15.3.4, "Configuring an arbitrary waveform"](#), on page 405.

15.1.4.1 Arbitrary waveform files

You can load CSV files that have a Rohde & Schwarz WaveGen format.

Content and format of the Rohde & Schwarz arbitrary waveform CSV files

The waveform generator format can contain the following values:

- Rate
- Time value
- Voltage value

If all the values are defined, the file format is as follows:

```
Rate = 5000000           //Sample rate of the arbitrary waveform.
0.000000E+000,-5.995    //Time value 1, Voltage value 1
1.237011E-005,-6.0      //Time value 2, Voltage value 2
.....
```

In this case, the rate is reflected in the "Sample Rate" field of the user interface. The total number of Time/Voltage values is reflected in the "Samples" of the user interface. Anything written after // is ignored as a comment.

You can define only some of the values. According to what you define, the file format looks different and is handled differently:

- With specified *Rate*:

Time values are ignored. You can specify just rate and voltage values as below:

```
Rate = 5000000           //Sample rate of the arbitrary waveform
-5.995                   //Voltage value 1
-6.0                     //Voltage value 2
.....
```

- Without specified *Rate* and without specified *Time* values:
The last user-defined sample rate is used to calculate the waveform. You can change the "Sample rate" in the user interface. The voltage values are then played with this sample rate.

```
-5.995                   //Voltage value 1
-6.0                     //Voltage value 2
.....
```

- Without specified *Rate* and with specified *Time*:
The timing information of the first 2 time values is used to calculate the sample rate.

Example:

Consider the following file:

```
0.000000E+000,-5.995     //Time value 1, Voltage value 1
1.237011E-005,-6.0      //Time value 2, Voltage value 2
```

The sample rate is:

$Sample\ rate = 1 / Time\ between\ first\ two\ samples = 1 / 1.237011E-005 = 80.840K\ Sample/sec$

15.1.4.2 Arbitrary settings

Access: "Gen" signal activator> "Gen1" or "Gen2" > "Setup" tab > "Function type" = "Arbitrary"

The following settings in the "Setup" tab and the "Arbitrary Setup" dialog are specific for generated arbitrary waveforms.

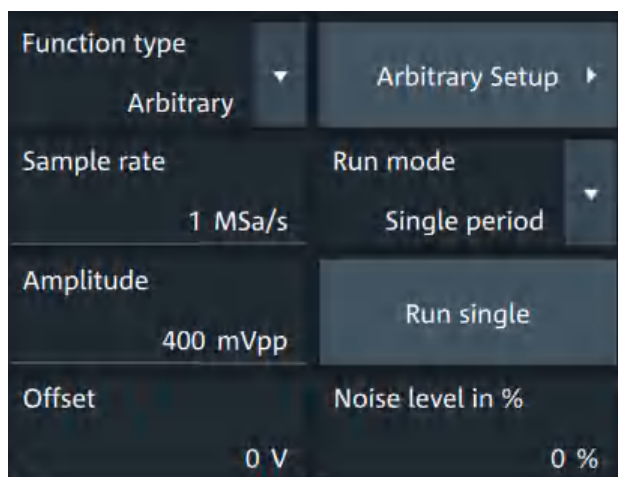

Run mode	400
Run single	400
Arbitrary Setup	400
Arb wfm source	401
Sample rate	401
Number of samples	401
Open	401

Run mode

Selects the duration for which the signal of the arbitrary generator is output after the trigger event. You can choose between a "Continuous" and "Single period" duration.

Remote command:

[WGENerator<wg>:ARBGen:RUNMode](#) on page 776

Run single

Generates a single period of the arbitrary waveform if "Run mode" is set to "Single period".

If you load the arbitrary waveform from file, first load the file, and then connect the DUT. See also: "[Open](#)" on page 401.

Remote command:

[WGENerator<wg>:ARBGen:RUNSingle](#) on page 776

Arbitrary Setup

Opens a dialog to define the arbitrary waveform.

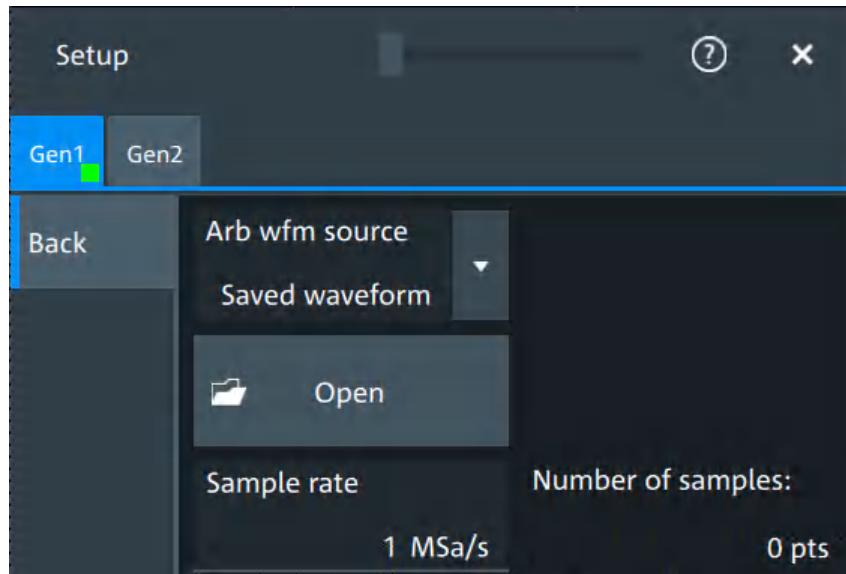

Arb wfm source

Selects the source of the arbitrary waveform.

You can load CSV files that follow a defined structure, or saved reference waveforms. See also: "[Open](#)" on page 401.

Remote command:

[WGENerator<wg>:ARBGen\[:SOURCE\]](#) on page 777

Sample rate

Sets the sample rate for the arbitrary waveform.

If the sample rate is given in the arbitrary waveform file (CSV or REF file), the instrument displays the value here, and you can change it. If no sample rate is available in the data, you can set the required sample rate.

Remote command:

[WGENerator<wg>:ARBGen:SRATe](#) on page 777

Number of samples

Displays the number of samples in the loaded waveform.

Remote command:

[WGENerator<wg>:ARBGen:SAMPles?](#) on page 776

Open

Opens a dialog to select the saved waveform, and loads the file. The setting is available if "Arb wfm source" is set to "Saved waveform".

You can load CSV files, or REF waveforms (saved reference waveforms). See also: [Chapter 15.1.4.1, "Arbitrary waveform files"](#), on page 398.

When the file is loaded, the output voltage is set to the value of the first sample in the file. Therefore, if you want to output single periods of the arbitrary waveform, first load the waveform file, and then connect the DUT.

Remote command:

[WGENerator<wg>:ARBGen:NAME](#) on page 775

[WGENerator<wg>:ARBGen:OPEN](#) on page 775

15.2 Synchronize settings

Access: "Menu" > "Apps" > "Gen1" > "Synchronisation" tab.

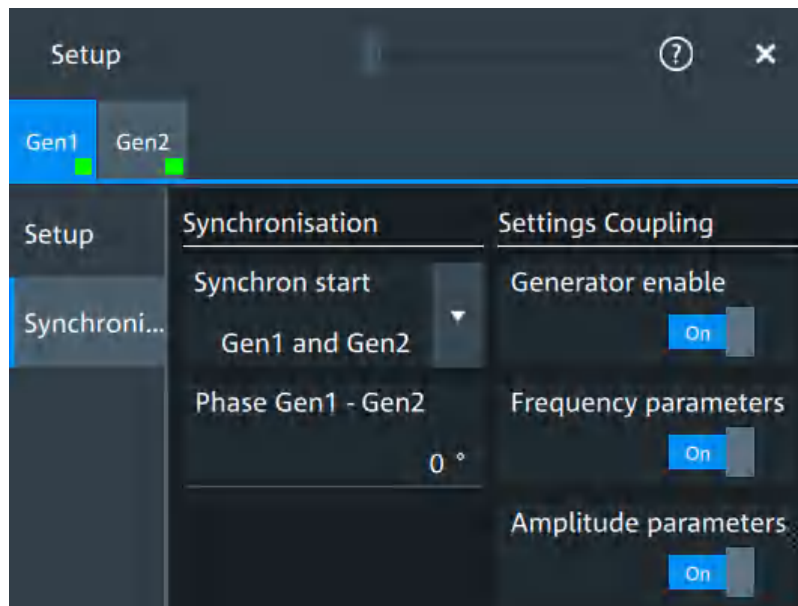

Synchron start

Selects, which signals generated from the waveform generator are synchronized.

Selecting one of the sync options indicates that the first samples of those signals are generated at the same time, irrespective of if the generators are on or off. Selecting one of the coupling options automatically syncs the signals generated by the two waveform generators.

Remote command:

[GENerator:SYNC\[:COMBination\]](#) on page 780

Generator enable

Enables the coupling of the generators, with the selected set of parameters: amplitude and frequency.

Remote command:

[WGENerator<wg>:COUpling:STATe](#) on page 779

Frequency parameters

Couples all frequency parameters of "Gen1" and "Gen2". The values are taken from the currently selected generator.

You can still change the other settings of the generators independently.

Remote command:

[WGENerator<wg>:COUPling:AMPLitude](#) on page 779

Amplitude parameters

Couples all amplitude parameters of "Gen1" and "Gen2" including the load. The values are taken from the currently selected generator.

Remote command:

[WGENerator<wg>:COUPling\[:FREQuency\]](#) on page 780

Phase Gen1 - Gen2

Sets the phase shift between the waveform of Gen1 and Gen2 when the frequency parameters of the two waveforms are coupled.

Remote command:

[WGENerator<wg>:COUPling:PHASeshift](#) on page 780

15.3 Configuring the waveform generator

This chapter explains step by step how to configure the waveform generator.

- [Configuring a function waveform](#).....403
- [Configuring a modulation waveform](#).....403
- [Configuring a sine sweep waveform](#).....405
- [Configuring an arbitrary waveform](#).....405

15.3.1 Configuring a function waveform

1. Tap the "Gen" signal activator.
2. Select the tab of the generator that you want to configure: "Gen"1 or "Gen"2.
3. In the "Setup" tab, select the "Function type" that you want to generate, e.g. "Sine".
4. Depending on the selected "Function type", configure the settings of the waveform like "Frequency" and "Amplitude".
5. If necessary, change the "User load" settings, or add "Noise level in %" to the waveform.
6. Set "State" = "On" to output the waveform at the output connector of the waveform generator.

15.3.2 Configuring a modulation waveform

Generating an AM modulated waveform

1. Tap the "Gen" signal activator.

2. Select the tab of the generator that you want to configure: "Gen"1 or "Gen"2.
3. In the "Setup" tab, set the "Function type" = "Sine".
4. Press "Modulation" to open the modulation dialog.
5. Set "Modulation type" = "AM".
6. Set the "Carrier frequency" and the "Carrier period".
7. Tap "Modulation signal", and select the required waveform.
8. Depending on the selected "Modulation signal", configure the settings of the waveform like "Modulation freq" and "Modulation depth".
9. Set "Modulation state" = "On" to enable the modulation.
10. Press "Back" to return to the "Setup" tab.
11. Set "State" = "On" to output the waveform at the output connector of the waveform generator.

Generating an FM modulated waveform

1. Tap the "Gen" signal activator.
2. Select the tab of the generator that you want to configure: "Gen"1 or "Gen"2.
3. In the "Setup" tab, set the "Function type" = "Sine".
4. Press "Modulation" to open the modulation dialog.
5. Set "Modulation type" = "FM".
6. Select the "Signal type".
7. Set the "Frequency" and the "Deviation".
8. Set "Modulation state" = "On" to enable the modulation.
9. Press "Back" to return to the "Setup" tab.
10. Set "State" = "On" to output the waveform at the output connector of the waveform generator.

Generating an FSK modulated waveform

1. Tap the "Gen" signal activator.
2. Select the tab of the generator that you want to configure: "Gen"1 or "Gen"2.
3. In the "Setup" tab, set the "Function type" = "Sine".
4. Press "Modulation" to open the modulation dialog.
5. Set "Modulation type" = "FSK".
6. Set the "Frequency 1", "Frequency 2" and the "FSK rate".
7. Set "Modulation state" = "On" to enable the modulation.

8. Press "Back" to return to the "Setup" tab.
9. Set "State" = "On" to output the waveform at the output connector of the waveform generator.

Generating a PWM modulated waveform

1. Tap the "Gen" signal activator.
2. Select the tab of the generator that you want to configure: "Gen"1 or "Gen"2.
3. In the "Setup" tab, set the "Function type" = "Square".
4. Press "Modulation" to open the modulation dialog.
5. Set "Modulation type" = "PWM".
6. Tap "Signal type", and select the required waveform.
7. Configure the settings of the waveform like "Frequency" and "Modulation depth".
8. Set "Modulation state" = "On" to enable the modulation.
9. Press "Back" to return to the "Setup" tab.
10. Set "State" = "On" to output the waveform at the output connector of the waveform generator.

15.3.3 Configuring a sine sweep waveform

1. Tap the "Gen" signal activator.
2. Select the tab of the generator that you want to configure: "Gen"1 or "Gen"2.
3. In the "Setup" tab, set "Function type" = "Sine".
4. Press "Sweep" to open the sweep dialog.
5. Select the "Sweep type".
6. Set the "Start frequency", the "Stop frequency" and the "Sweep time".
7. Set "Sweep state" = "On" to enable the sweep.
8. Press "Back" to return to the "Setup" tab.
9. Set "State" = "On" to output the waveform at the output connector of the waveform generator.

15.3.4 Configuring an arbitrary waveform

For a description of the settings, see [Chapter 15.1.4, "Arbitrary waveforms"](#), on page 398.

Generating an arbitrary waveform from a saved file

If you want to output single periods of the arbitrary waveform, first set up the generator, and then connect the DUT.

1. Tap the "Gen" signal activator.
2. Select the tab of the generator that you want to configure: "Gen1" or "Gen2".
3. In the "Setup" tab, set "Function type" = "Arbitrary".
4. Select "Arbitrary Setup" to open the arbitrary dialog.
5. Set the "Arb wfm source" to "Saved waveform".
6. Set the "Sample rate" if it is not defined in the file data.
7. Check "Number of samples".
8. Select "Back" to return to the "Setup" tab.
9. Select the "Run mode".
10. If "Run mode" = "Repetitive", set "State" = "On" to output the waveform at the output connector of the waveform generator.
11. If "Run mode" = "Single period":
 - a) Connect the DUT.
 - b) Set "State" = "On" to enable the output of the waveform generator.
 - c) Tap "Run single" to output one waveform.

Generating an arbitrary waveform from the scope waveform

1. Tap the "Gen" signal activator.
2. Select the tab of the generator that you want to configure: "Gen1" or "Gen2".
3. In the "Setup" tab, set "Function type" = "Arbitrary".
4. Select "Arbitrary Setup" to open the arbitrary dialog.
5. Set the "Arb wfm source" to "Scope waveform".
6. Select the "Signal source", the waveform source for the generated waveform.
7. Tap "Update" to load the selected waveform.
8. Press "Back" to return to the "Setup" tab.
9. Select the "Run mode".
10. Set "State" = "On" to enable the output of the generated waveform.
11. If "Run mode" = "Single period", tap "Run single" to output one waveform.

16 Network operation and remote control

The operating system is the basis of the instrument's firmware, it provides basic functions such as logon, password protection, virus protection, and connection to a network.

In addition to working with the R&S MXO 5 directly, using the touchscreen and the keys, you can also operate the instrument from a remote PC. Various methods of remote operation and control in a LAN network are supported:

- Using the web interface
- Using a VNC client
- Remote control with SCPI commands



The following descriptions provide information required for operating the R&S MXO 5 remotely. Definitions specified in the SCPI standard are not provided.

For basic knowledge on remote control operation and additional information, see the following documents, available on the Rohde & Schwarz website:

- [Remote control via SCPI](#)

• Connecting the instrument to the network (LAN)	407
• Web interface	410
• Remote operation with VNC client	415
• Remote control	415
• Remote control - status reporting system	418

16.1 Connecting the instrument to the network (LAN)

Network environment

Before connecting the product to a LAN, consider the following:

- Install the latest firmware to reduce security risks.
- For internet or remote access, use secured connections if applicable.
- Ensure that the network settings comply with the security policies of your company. Contact your local system administrator or IT department before connecting your product to your company LAN.
- When connected to the LAN, the product may potentially be accessed from the internet, which may be a security risk. For example, attackers might misuse or damage the product.

16.1.1 Connecting the instrument to the network

There are two methods to establish a LAN connection to the instrument:

- A non-dedicated network (Ethernet) connection from the instrument to an existing network.
- A dedicated network connection (Point-to-point connection) between the instrument and a single computer.

To connect a LAN cable

- ▶ Connect an RJ-45 cable to the LAN connector on the rear panel, and to the LAN.

For supported LAN interfaces, refer to the data sheet.

16.1.2 Assigning the IP address

Depending on the network capacities, the TCP/IP address information for the instrument can be obtained in different ways.

- If the network supports the Dynamic Host Configuration Protocol (DHCP), the address is assigned automatically.
- If the network does not support DHCP, or if the instrument is set to use manual configuration, the addresses must be set manually.

By default, the instrument is configured to use DHCP and obtains all address information automatically. Thus it is safe to establish a physical connection to the LAN without any previous instrument configuration.



Ensure that you do not use the IP address range 192.168.0.x to avoid internal address conflict.

Setting up a manual IP address within this range is rejected by the firmware. If the automatic DHCP server assigns an IP address within this range, the instrument is not reachable from this network.

An error message is displayed, if the firmware detects an IP address error:

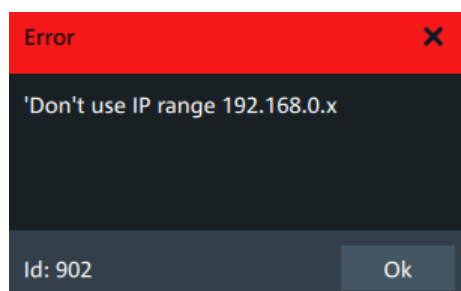

To assign the IP address manually on the instrument

1. **NOTICE!** Connection errors can affect the entire network. If your network does not support DHCP, or if you choose to disable dynamic TCP/IP configuration, you must assign valid address information before connecting the instrument to the LAN.

Contact your network administrator to obtain a valid IP address.

2. Open "Menu" > "Settings".
3. Select "System" > "Network" > "Advanced".
4. Disable "Automatic IP (DHCP)".
5. Enter the address information as obtained from the network administrator.

16.1.3 Using host names

In a LAN that uses a DNS server (Domain Name System server), each computer and instrument in the LAN can be accessed via an unambiguous host name (or computer name) instead of the IP address. The DNS server translates the host name to the IP address. Host names are useful when a DHCP server is used, as a new IP address can be assigned each time the instrument is restarted.

Each instrument is delivered with an assigned host name, but you can change this name.

The default host name is the device name, a non-case-sensitive string with the following syntax: <instrument_model>-<serial_number>.

For example, the default host name of an MXO58 with serial number 123456 is MXO58-123456.

You can find the current host name, the model and the serial number in the "Device summary", when you tap the Rohde & Schwarz logo in the upper right corner of the screen. See also: [Chapter 4.11, "Information and notifications"](#), on page 65.

The serial number can also be found on the rear panel of the instrument. It is the third part of the device ID printed on the barcode sticker:



To change the host name

1. Open the "Menu".
2. Select "Settings" > "System" > "Network".
3. In "Device name", enter the new host name.
4. Confirm the entry.

16.2 Web interface

If the R&S MXO 5 is connected to a computer via LAN, you can operate the instrument from the computer. No additional tools are required, you need only a web browser.

16.2.1 Settings on the R&S MXO 5



The connection status icon in the upper right corner indicates the status of the LAN connection. A green icon indicates that the instrument is connected to the LAN; a red symbol indicates a connection error - mostly the LAN cable is not connected.



The "Network" tab of the "System" dialog box provides network information and settings. See [Chapter 5.1.2, "Network settings"](#), on page 70.

16.2.2 Web browser

The instrument's web interface works with all W3C compliant browsers.

1. Open a browser on a computer connected to the instrument via LAN.
2. Type the instrument's host name or IP address in the address field of the browser on your PC, e.g. "http://11.111.11.222".

The instrument homepage opens.

The instrument homepage displays the device information in read-only format, including DNS host names and the VISA resource string.

The navigation menu of the browser interface has the following items:

- "LAN configuration" opens the menu with configuration pages.
- "Web control" emulates the front panel and shows the instrument display. You see a live image of the instrument, and you can operate the instrument remotely. You can use the keys, the knobs and the menus in the same way as directly on the instrument.
- "File manager" provides access to the user data that is saved on the instrument, upload and download.

16.2.2.1 LAN configuration

The LAN configuration consists of several parts:

- "General"
- "IP configuration" provides all mandatory LAN parameters.
- "Advanced configuration" provides LAN settings that are not declared mandatory by the standard.
- "Ping client" provides the ping utility to verify the connection between the instrument and other devices.

Changing the LAN parameters requires the "Web Ifc Password" password, which is set on the instrument.

IP configuration

The "LAN Configuration > IP configuration" webpage displays all mandatory LAN parameters and allows their modification. Changing the LAN parameters requires the "Web Ifc Password" password, which is set on the instrument.

Device web > LAN configuration

Home | LAN configuration | Web control | File Manager

General | **IP configuration** | Advanced configuration | Ping client

Configure adapter: Wired connection 1

Adapter settings

Domain: [blurred]

Register Device at DNS Server automatically:

IPv4 settings

The "IP address mode" controls how the IP address for the instrument gets assigned. For the manual configuration mode, at least the static IP address, subnet mask, and default gateway are used to configure the LAN. The automatic configuration mode uses DHCP server or Dynamic Link Local Addressing to obtain the instrument IP address.

The same settings are available on the instrument under "Menu" > "Settings" > "System" > "Network" > "Advanced".

Advanced configuration

The "LAN Configuration > Advanced configuration" parameters are used as follows:

- mDNS and DNS-SD are two additional protocols: Multicast DNS and DNS Service Discovery. They are used for device communication in zero configuration networks working without DNS and DHCP.
- "ICMP ping" must be enabled to use the ping utility.
- "VXI-11" is the protocol that is used to detect the instrument in the LAN.

Device web > LAN configuration

Home | LAN configuration | Web control | File Manager

General | IP configuration | **Advanced configuration** | Ping client

Device settings

mDNS and DNS-SD: mDNS & DNS-SD ▼

IPv4 settings

ICMP ping:

VXI-11 discovery:

IPv6 settings

ICMP ping:

Privacy extension:

✓ Apply

Ping client

Ping is a utility that verifies the connection between the instrument and another device. The ping command uses the ICMP echo request and echo reply packets to determine whether the LAN connection is functional. Ping is useful for diagnosing IP network or router failures. The ping utility is not password-protected.

Device web > LAN configuration

Home | LAN configuration | Web control | File Manager

General | IP configuration | Advanced configuration | **Ping client**

Destination address: ▲

Clear Submit

To initiate a ping between the compliant instrument and a second connected device:

1. Enable "ICMP ping" on the "Advanced configuration" page (enabled by default).
2. On the "Ping client" page, enter the IP address of the second device **without the ping command and without any further parameters** into the "Destination address" field (e.g. *11.113.11.203*).
3. Click "Submit".

16.2.2.2 Web control

"Web Control" emulates the front panel and shows the instrument display. You see a live image of the instrument, and you can operate the instrument remotely. You can use the keys, the knobs and the menus in the same way as directly on the instrument.

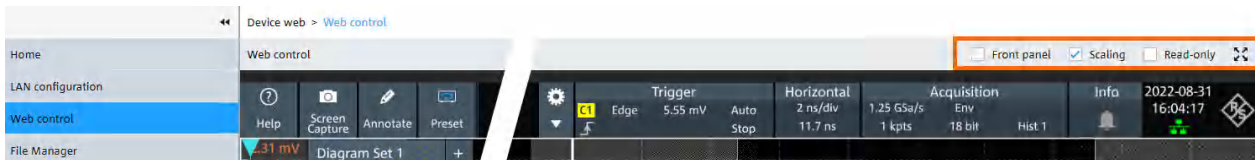

In the upper right corner above the emulated display, you see some options:

- "Front panel" hides or shows the front panel.
- "Scaling" scales the diagram to show it completely. If disabled, the diagram is shown in its original size.
- "Read-only" disables operating, only viewing is possible
- The arrows icon hides or shows the menu.

16.2.2.3 File manager

The file manager on the instrument's webpage provides access to the user data that is stored on the instrument, or on a USB flash device connected to the instrument.

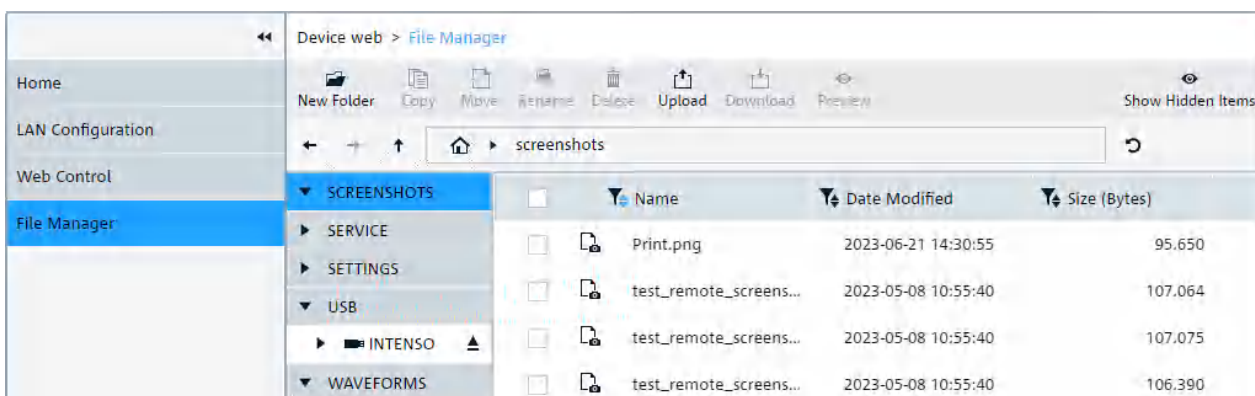

In the web file manager, you can organize the data:

- Create folders
- Copy files within the instrument's file system, or from and to USB flash device. Multiple files selection is possible.
- Move files within the instrument's file system, or from and to USB flash device. Multiple files selection is possible.
- Rename files
- Delete files
- Upload files from the operating computer to the instrument. Multiple files can be uploaded at once.

- Download files from the instrument to the operating computer. Multiple files selection is possible.
- Preview file content of text files with maximum size of 500 kbyte.

After attaching a USB flash device, creating a screenshot or other actions, the file manager might not display the last change:

- ▶ Click the "Refresh" icon on the right of the address field to update the display.

Note that the "Eject" button for USB flash devices has no function when operating the instrument remotely.

16.2.2.4 Mapping the instrument's file system as network drive

Using web-based distributed authoring and versioning (WebDAV), you can access and exchange files over the internet: move, cut, copy and paste files from the instrument to the computer and vice versa. Therefore, map the instrument's file system as network drive in the file explorer of the operating computer:

The instrument is connected to LAN, and the connection status icon in the upper right corner of the instrument's display is green.

1. Open the file explorer on the operating computer.
2. In the left list, right-click "Network" or the entry of the operating computer, and select "Map network drive".
3. Enter the path to the instrument's file system:

`http://<hostname>/webdavData.`

Example: `http://MX058-123456/webdavData`

You can find the hostname in the "Device summary", which is shown when you tap the Rohde & Schwarz logo in the upper right corner of the instrument's screen. The default host name is `<instrument_model>-<serial_number>`.

4. Activate "Connect using different credentials".

←  Map Network Drive

What network folder would you like to map?

Specify the drive letter for the connection and the folder that you want to connect to:

Drive:

Folder:

Example: `\\server\share`

Reconnect at sign-in

Connect using different credentials

[Connect to a Web site that you can use to store your documents and pictures.](#)

5. Click "Finish".

6. Leave the "User name" and "Password" empty. Click "OK".

If there are problems with the connection, check if the "WebClient" service is running: "Task Manager" > "Services" tab. If the "WebClient" service is not running, start it.

16.3 Remote operation with VNC client

If the R&S MXO 5 is connected to a computer via LAN, you can operate the instrument from the computer using a VNC client. Therefore, install a VNC client on the computer.

To operate the instrument via VNC client:

1. Start the VNC client.
2. Enter the hostname (device name) of the instrument. You find the name in the instrument information on the oscilloscope. Tap the Rohde & Schwarz logo to show the information.
3. Connect to the instrument.

You see the display of the oscilloscope and can use the menus, dialogs, SmartGrid and all operating means of the display.

16.4 Remote control

Remote control automates the operation of the instrument using SCPI commands, scripts and programs.

For general information on remote control of Rohde & Schwarz products via SCPI, refer to www.rohde-schwarz.com/rc-via-scp.

The following sections describe the instrument-specific basics of remote control. SCPI commands are listed and described in chapter [Chapter 17, "Remote control commands"](#), on page 428.

- [Remote control interfaces and protocols](#).....415
- [Starting and stopping remote control](#).....417

16.4.1 Remote control interfaces and protocols

The instrument supports different interfaces for remote control. The following table gives an overview.

Table 16-1: Remote control interfaces and protocols

Interface	Protocols, VISA address string	Remarks
Local Area Network (LAN)	<p>Protocol HiSLIP</p> <p>VISA address string: TCP/IP::<host address="">:: hislip0[, <port>] [::INSTR]</host></p> <p>Protocol VXI-11</p> <p>VISA address string: TCP/IP::<host address="">:: inst0]::[INSTR]</host></p>	<p>The LAN connector is located on rear panel of the instrument.</p> <p>The interface is based on TCP/IP and supports various protocols.</p>

16.4.1.1 LAN interface

To be integrated in a LAN, the instrument is equipped with a LAN interface, consisting of a connector, a network interface card and protocols. The interface details are given in the specifications.

For remote control via a network, the PC and the instrument must be connected via the LAN interface to a common network with TCP/IP network protocol. They are connected using a commercial RJ-45 cable (shielded or unshielded twisted-pair category 5 or better). The TCP/IP network protocol and the associated network services are preconfigured on the instrument. Software for instrument control and the VISA program library must be installed on the controller.

IP address

Only the IP address or a valid DNS host name is required to set up the connection. The host address is part of the "VISA resource string" used by programs to identify and control the instrument. The VISA resource string has the form:

TCP/IP::::hislip0[, <port>] [::INSTR] for HiSLIP protocol

TCP/IP::::inst0] [::INSTR] for VXI-11 protocol

Where:

- `host address` identifies the instrument in the network, usually the IP address. If the LAN is supported by a DNS server, the host name can be used instead of the IP address. The DNS server (Domain Name System server) translates the host name to the IP address.
- `hislip0` indicates the HiSLIP protocol.
- `inst0` is the default LAN device name. VISA supports several devices running on the instrument. On R&S MXO 5, only one device is configured, so the LAN device name can be omitted.
- `INSTR` specifies a VISA resource of the type INSTR. By default, the VISA resource name control is set to the INSTR class.

Example: HiSLIP

IP address is *192.1.2.3*: the valid resource string is: `TCPIP::192.1.2.3::hislip0`

Instrument name is *RSRT1*: the valid resource string is: `TCPIP::RSRT1::hislip0`.

DNS host name is *MXO5-123456*: the valid resource string is:

`TCPIP::MXO5-123456::hislip0`.

Example: VXI-11

IP address is *192.1.2.3*: the valid resource string is: `TCPIP::192.1.2.3`

Instrument name is *RSRT1*: the valid resource string is: `TCPIP::RSRT1`.

DNS host name is *MXO5-123456*: the valid resource string is:

`TCPIP::MXO5-123456`.

16.4.2 Starting and stopping remote control

16.4.2.1 Starting a remote control session

When you switch on the instrument, it is always in manual operation state ("local" state). It can be operated via the front panel, the touchscreen and external keyboard and/or mouse.

- ▶ To start remote control:
 - Send a command from the controller.
 - VXI-11 protocol (LAN or USB interface): Use `>R` interface message.

While remote control is active, the instrument settings are optimized for maximum measurement speed; the display is switched off. Operation via the front panel is disabled.

On the touchscreen, two buttons appear in the upper left corner: "Local" and "View".

16.4.2.2 Using the display during remote control

You can observe the screen while a remote control script is executed. Displaying the results of script execution is helpful for program test purposes but tends to slow down the measurement. Therefore it is recommended that you switch off the display in real measurement applications where a tested program script is to be executed repeatedly.

- ▶ To switch on the display, do one of the following:
 - Tap the "View" button in the upper left corner of the touchscreen.
 - Use the `SYSTem:DISPlay:UPDate ON` command.
- ▶ To switch off the display, do one of the following:
 - Tap the "View" button again.

- Use the `SYSTem:DISPlay:UPDate OFF` command.

16.4.2.3 Returning to manual operation

The instrument switches back to manual operation when the remote connection is closed. Besides, you can return to manual operation manually or via remote control.

- ▶ To return to manual operation:
 - Tap the "Local" button in the upper left corner of the touchscreen.
 - VXI-11 protocol: Use `>L` interface message.

16.5 Remote control - status reporting system

The status reporting system stores all information on the current operating state of the instrument, and on errors which have occurred. This information is stored in the status registers and in the error queue. Both can be queried via `STATus...` commands.

16.5.1 Hierarchy of status registers

As shown in the following figure, the status information is of hierarchical structure.

The output buffer contains the messages that the instrument returns to the controller. It is not part of the status reporting system but determines the value of the `MAV` bit in the `STB` and thus is represented in the overview.

All status registers have the same internal structure.

16.5.2 Structure of a SCPI status register

The `STATUS:OPERation` and the `STATUS:QUESTIONable` SCPI status registers consists of five parts.

The individual bits are independent of each other, i.e. each hardware status is assigned a bit number, which is valid for all five parts. Bit 15 (the most significant bit) is set to zero for all parts. Thus, the contents of the register parts can be processed by the controller as positive integers.

Description of the five status register parts

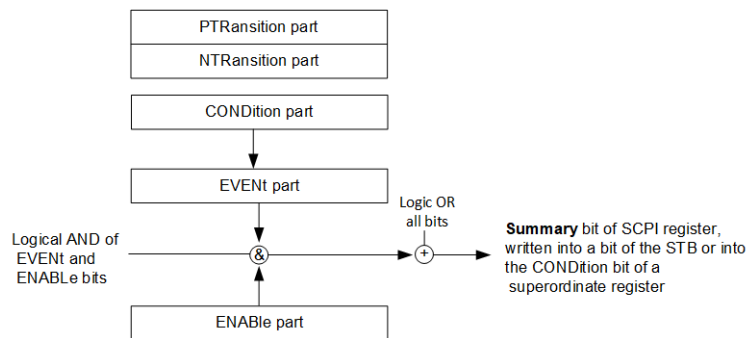

The five parts of a SCPI status register have different properties and functions:

- CONDition**

The `CONDition` part reflects the current instrument status. For summary bits, the `CONDition` bit mirrors the sum of the enabled `EVENT` bits of the next lower register.

This register part can only be read, but not written into or cleared. Its contents are not affected by reading.
- PTRansition / NTRansition**

The two transition register parts define which state transition of the `CONDition` part (none, 0 to 1, 1 to 0 or both) is stored in the `EVENT` part.

The **Positive-TTransition** part acts as a transition filter. When a bit of the `CONDition` part is changed from 0 to 1, the associated `PTR` bit decides whether the `EVENT` bit is set to 1.

 - `PTR` bit =1: the `EVENT` bit is set.
 - `PTR` bit =0: the `EVENT` bit is not set.

All positive transitions are enabled by default.

This part can be written into and read as required. Its contents are not affected by reading.

The **Negative-Transition** part also acts as a transition filter. When a bit of the `CONDition` part is changed from 1 to 0, the associated `NTR` bit decides whether the `EVENT` bit is set to 1.

- `NTR` bit =1: the `EVENT` bit is set.
- `NTR` bit =0: the `EVENT` bit is not set.

All negative transitions are disabled by default.

This part can be written into and read as required. Its contents are not affected by reading.

- **EVENT**

The `EVENT` part indicates whether an event has occurred since the last reading. It is the "memory" of the condition part. It allows you to detect the occurrence of events reliably, even if they have changed the state of the `CONDition` bit for a very brief interval. It only indicates events passed on by the transition filters. This part can only be read by the user. **Reading the register clears it.**

- **ENABLE**

The `ENABLE` part determines whether the associated `EVENT` bit contributes to the summary bit (see below). Each bit of the `EVENT` part is "ANDed" with the associated `ENABLE` bit (symbol '&'). The results of all logical operations of this part are passed on to the summary bit via an "OR" function (symbol '+').

`ENABLE` bit = 0: the associated `EVENT` bit does not contribute to the summary bit
`ENABLE` bit = 1: if the associated `EVENT` bit is "1", the summary bit is set to "1" as well.

This part can be written into and read by the user as required. Its contents are not affected by reading.

16.5.3 Contents of the status registers

16.5.3.1 Status byte (STB) and service request enable register (SRE)

The `STatus Byte` (STB) is already defined in IEEE 488.2. It provides a rough overview of the instrument status by collecting the pieces of information of the lower registers. A special feature is that bit 6 acts as the sum bit of the remaining bits of the status byte.

The STB can thus be compared with the `CONDition` part of an SCPI register and assumes the highest level within the SCPI hierarchy.

The STB is read using the command `*STB?` or a serial poll.

The `STatus Byte` (STB) is linked to the `Service Request Enable` (SRE) register. Each bit of the STB is assigned a bit in the SRE. Bit 6 of the SRE is ignored. If a bit is set in the SRE and the associated bit in the STB changes from 0 to 1, a service request (SRQ) is generated. The SRE can be set using the command `*SRE` and read using the command `*SRE?`.

Table 16-2: Meaning of the bits used in the status byte

Bit No.	Meaning
0...1	Not used
2	Error Queue not empty The bit is set when an entry is made in the error queue. If this bit is enabled by the SRE, each entry of the error queue generates a service request. Thus an error can be recognized and specified in greater detail by polling the error queue. The poll provides an informative error message. This procedure is to be recommended since it considerably reduces the problems involved with remote control.
3	QUESTionable status register summary bit The bit is set if an EVENT bit is set in the QUESTionable status register and the associated ENABLE bit is set to 1. A set bit indicates a questionable instrument status, which can be specified in greater detail by querying the STATus:QUESTionable status register.
4	MAV bit (message available) The bit is set if a message is available in the output queue which can be read. This bit can be used to enable data to be automatically read from the instrument to the controller.
5	ESB bit Sum bit of the event status register. It is set if one of the bits in the event status register is set and enabled in the event status enable register. Setting of this bit indicates a serious error which can be specified in greater detail by polling the event status register.
6	MSS bit (main status summary bit) The bit is set if the instrument triggers a service request. This is the case if one of the other bits of this registers is set together with its mask bit in the service request enable register SRE.
7	STATus:OPERation status register summary bit The bit is set if an EVENT bit is set in the OPEration status register and the associated ENABLE bit is set to 1. A set bit indicates that the instrument is just performing an action. The type of action can be determined by querying the STATus:OPERation status register.

16.5.3.2 Event status register (ESR) and event status enable register (ESE)

The ESR is defined in IEEE 488.2. It can be compared with the EVENT part of a SCPI register. The event status register can be read out using command *ESR?.

The ESE corresponds to the ENABLE part of a SCPI register. If a bit is set in the ESE and the associated bit in the ESR changes from 0 to 1, the ESB bit in the STB is set.

The ESE register can be set using the command *ESE and read using the command *ESE?.

Table 16-3: Meaning of the bits used in the event status register

Bit No.	Meaning
0	Operation complete This bit is set on receipt of the command *OPC exactly when all previous commands have been executed.
1	Not used

Bit No.	Meaning
2	Query error This bit is set if the controller wants to read data from the instrument without having sent a query. It is also set if the controller does not fetch requested data and sends new instructions to the instrument instead. The cause is often a query which is faulty and hence cannot be executed.
3	Device-dependent error This bit is set if a device-dependent error occurs. An error message with a number between -300 and -399 or a positive error number, which denotes the error in greater detail, is entered into the error queue.
4	Execution error This bit is set if a received command is syntactically correct but cannot be performed for other reasons. An error message with a number between -200 and -300, which denotes the error in greater detail, is entered into the error queue.
5	Command error This bit is set if a command is received, which is undefined or syntactically incorrect. An error message with a number between -100 and -200, which denotes the error in greater detail, is entered into the error queue.
6	User request This bit is set when the instrument is switched over to manual control.
7	Power on (supply voltage on) This bit is set when you turn on the instrument.

16.5.3.3 STATus:OPERation register

In the `CONDition` part, this register contains information on which actions the instrument is executing. In the `EVENT` part, it contains information on which actions the instrument has executed since the last reading.

It can be read using the commands `STATus:OPERation:CONDition?` or `STATus:OPERation[:EVENT]?`, see also [Chapter 17.19.2, "STATus:OPERation register"](#), on page 781.

Table 16-4: Bits in the STATus:OPERation register

Bit No.	Meaning
0	<code>ALIGNment</code> This bit is set as long as the instrument is performing a self-alignment.
1	Not used
2	<code>AUToset</code> This bit is set while the instrument is performing an auto setup.
3	Not used
4	<code>MEASuring</code> The bit is set as long as an acquisition - sampling and postprocessing - is running. In run continuous mode, the bit is always set.

Bit No.	Meaning
5	<p>WTRigger</p> <p>Available only for single acquisitions or the first acquisition of continuous acquisitions.</p> <p>The wait for trigger status bit indicates that the instrument is ready to trigger, and the pre-trigger time is expired.</p> <p>The bit is set for as long as a measurement is running.</p>
6	<p>TRiggered</p> <p>Available only for single acquisitions or the first acquisition of continuous acquisitions.</p> <p>The triggered status bit indicates that the instrument has been triggered.</p>
7 - 15	Not used

16.5.3.4 STATUS:QUESTIONable register

This register contains specific information on instrument operation and signal reliability. It can be read using the commands `STATUS:QUESTIONable:CONDition?` and `STATUS:QUESTIONable[:EVENT]?`.

The remote commands for the STATUS:QUESTIONable register are described in [Chapter 17.19, "Status reporting"](#), on page 780.

Table 16-5: Bits in the STATUS:QUESTIONable register

Bit No.		Meaning
0	-	For future use.
1	PPSupply	This bit is set if probe power supply overload occurs.
2	POVerload	This bit is set if a probe overload occurs.
3	COVerload	This bit is set if a questionable channel overload occurs.
4	TEMPerature	This bit is set if a questionable temperature occurs.
5	ADCState	The bit is set if the signal is clipped on the upper or lower edge of the screen overflow of the ADC occurs.
6	GOVerload	This bit is set if a generator overload occurs.
7	-	For future use.
8	NOALigndata	This bit is set if no alignment data is available - the instrument is uncalibrated.
9	LIMit	This bit is set if a limit value is violated.
10	MARGIN	This bit is set if a margin value is violated, and the limit value is not violated.
11	IMPRecise	This bit is set if the magnitude of the signal is too low to get reliable measurement results.
12	-	For future use.

Bit No.		Meaning
13	PLLunlock	This bit is set if a phase-locked loop process is unlocked. There are two reasons: <ul style="list-style-type: none"> external reference is missing or defect hardware defect of internal PLL
14	-	For future use.

16.5.3.5 Application of the status reporting system

The purpose of the status reporting system is to monitor the status of one or several instruments in a test system. In particular, it monitors continuous measurements to detect errors in the signal. The controller must receive and evaluate the information of all devices.

The following standard methods are used:

- **Service request:** An SRQ is initiated by the instrument.
- Query of a **specific register** by commands
- Query of the **error queue**

These methods are described in the following sections.

Service request

The instrument can send a service request (SRQ) to the controller. Usually, this service request initiates an interrupt at the controller, to which the control program can react appropriately.

An SRQ is initiated if one or several of bits 2, 3, 4, 5 or 7 of the STB are set and enabled in the SRE. Each of these bits combines the information of a lower-level register, the error queue or the output buffer.

The `ENABLE` parts of the status registers can be set such that arbitrary bits in an arbitrary status register initiate an SRQ. To use service requests effectively, set all bits to "1" in the mask registers SRE and ESE.

The SRQ is the only possibility for the instrument to become active on its own. Configure the instrument so that it initiates a service request if errors occur. And ensure that your program reacts appropriately to service requests.

Query of a register

The STB and ESR registers contain 8 bits, the SCPI registers 16 bits. The contents of a status register are specified and transferred as a single decimal number. Therefore, each bit is assigned a weighted value. The decimal number is calculated as the sum of the weighted values of all bits in the register that are set to 1.

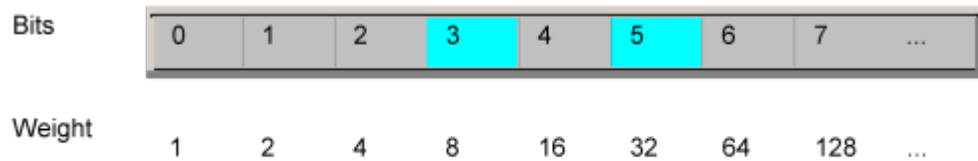
**Example:**

The decimal value 40 = 32 + 8 indicates that bits no. 3 and 5 in the status register (e.g. the `QUESTionable` status summary bit and the `ESB` bit in the `STatus` byte) are set.

16.5.4 Error queue

Each error state in the instrument leads to an entry in the error queue.

The error queue should be queried after every SRQ in the controller program as the entries describe the cause of an error more precisely than the status registers. Especially in the test phase of a controller program the error queue should be queried regularly since faulty commands from the controller to the instrument are recorded there as well.

16.5.5 Reset values of the status reporting system

The following table contains the different commands and events causing the status reporting system to be reset. None of the commands, except `*RST` and `SYSTEM:PRESet`, influence the functional instrument settings. In particular, `DCL` does not change the instrument settings.

Table 16-6: Resets of the status reporting system

Event	DCL, SDC (Device Clear, Selected Device Clear)	*RST or SYSTEM: PRESet	STATUS: PRESet	*CLS
Clear STB, ESR	-	-	-	yes
Clear SRE, ESE	-	-	-	-
Clear EVENT parts of the registers	-	-	-	yes
Clear ENABLE parts of all OPERATION and QUESTionable registers; Fill ENABLE parts of all other registers with "1".	-	-	yes	-
Fill PTRansition parts with "1"; Clear NTRansition parts	-	-	yes	-
Clear error queue	-	-	-	yes

Event	DCL, SDC (Device Clear, Selected Device Clear)	*RST or SYSTem: PRESet	STATus: PRESet	*CLS
Clear output buffer	yes	1)	1)	1)
Clear command processing and input buffer	yes	-	-	-
1) The first command in a command line that immediately follows a <PROGRAM MESSAGE TERMINATOR> clears the output buffer.				

17 Remote control commands

This chapter describes all remote commands available for R&S MXO 5 and provides examples and information how to use the commands.

For general information on remote control of Rohde & Schwarz products via SCPI, refer to www.rohde-schwarz.com/rc-via-scpi.

See also [Chapter 16.4, "Remote control"](#), on page 415 and [Chapter 16.5, "Remote control - status reporting system"](#), on page 418 for further information on remote control.



The description of the remote commands, assume a R&S MXO 5 with the highest available bandwidth and number of channels. Depending on your model, some of the available command ranges can differ from the values stated in the following chapters.

17.1 Conventions used in remote command description

The basics of SCPI command structure, syntax and command parameters are explained in www.rohde-schwarz.com/rc-via-scpi.

The following conventions are used in the remote command descriptions:

- **Command usage**
If not specified otherwise, commands can be used both for setting and for querying parameters.
If a command can be used for setting or querying only, or if it initiates an event, the usage is stated explicitly.
- **Parameter usage**
If not specified otherwise, a parameter can be used to set a value and it is the result of a query.
Parameters required only for setting are indicated as **Setting parameters**.
Parameters required only to refine a query are indicated as **Query parameters**.
Parameters that are only returned as the result of a query are indicated as **Return values**.
- **Conformity**
Commands that are taken from the SCPI standard are indicated as **SCPI confirmed**. All commands used by the R&S MXO 5 follow the SCPI syntax rules.
- **Asynchronous commands**
A command which does not automatically finish executing before the next command starts executing (overlapping command) is indicated as an **Asynchronous command**.
- **Reset values (*RST)**
Default parameter values that are used directly after resetting the instrument (*RST command) are indicated as ***RST** values, if available.
- **Default unit**

The default unit is used for numeric values if no other unit is provided with the parameter.

17.2 Finding the appropriate command

In the following chapters, the commands are sorted according to the menu and dialog structure of the instrument.

A list of all commands in alphabetical order is given in the "List of Commands" at the end of this documentation.

To find the appropriate command for a setting easily, you can use the context help:

1. Enable the "Help" icon on the toolbar.
2. Tap the parameter for which you need information.
The "Help" window opens and displays the comprehensive description and the corresponding remote command.
3. Tap the remote command link to open the command description.

17.3 Frequently used parameters and suffixes

This chapter describes in general those parameters and suffixes that are used in several subsystems.

17.3.1 Waveform parameter

Many commands require one of the waveforms to be specified as source. The following table lists all waveforms. For each command using a waveform parameter, the available waveforms are specified in the command description.

Waveform	Description
C1 C2 C3 C4 C5 C6 C7 C8 D0 D1 D2 D3 D4 D5 D6 D7 D8 D9 D10 D11 D12 D13 D14 D15 M1 M2 M3 M4 M5 M6 M7 M8 R1 R2 R3 R4 R5 R6 R7 R8 CHAN1 = C1, CHAN2 = C2, CHAN3 = C3, CHAN4 = C4, CHAN5 = C5, CHAN6 = C6, CHAN7 = C7, CHAN8 = C8	Channel waveforms
M1 M2 M3 M4 M5 M6 M7 M8	Math waveforms
R1 R2 R3 R4 R5 R6 R7 R8	Reference waveforms
SBUS1 SBUS2 SBUS3 SBUS4	Serial buses
D0 D1 D2 D3 D4 D5 D6 D7 D8 D9 D10 D11 D12 D13 D14 D15	Digital channels (option R&S MXO5-B1)

Waveform	Description
PBUS1 PBUS2 PBUS3 PBUS4	Digital buses (option R&S MXO5-B1)
SPECMAXH1 SPECMINH1 SPECNORM1 SPECAVER1	Spectrum traces: SPECMAXH1 : Spectrum1 maxhold SPECMINH1: Spectrum1 minhold SPECNORM1: Spectrum1 normal SPECAVER1: Spectrum1 average

17.3.2 Slope parameter

The slope parameter is used with several trigger and search condition commands.

Slope	Description
POSitive	Rising edge, which is a positive voltage change.
NEGative	Falling edge, which is a negative voltage change.
EITHer	Rising as well as the falling edge.

17.3.3 Polarity parameter

The polarity parameter is used with several trigger and search condition commands.

Polarity	Description
POSitive	Positive going pulses.
NEGative	Negative going pulses.
EITHer	Both positive and negative going pulses.

17.4 Programming examples

17.4.1 SmartGrid layout with zoom

The following example uses 3 sine waves, all with frequency 20 MHz and an amplitude of ± 0.4 V. The vertical scale is 100 mV/div, the time scale is 20 ns/div.

In the example, 2 layouts (diagram sets) are created, waveforms are assigned, and zoom and spectrum are added.

For a description of the commands, see:

- [Chapter 17.7.2, "SmartGrid"](#), on page 443
- [Chapter 17.10.1, "Zoom"](#), on page 518

- Chapter 17.14.1, "Spectrum setup", on page 588

```
//Prepeare: 3 channel signals.
//Enable C1, C2 and C3.
CHAN1:STAT 1
CHAN2:STAT 1
CHAN3:STAT 1
```

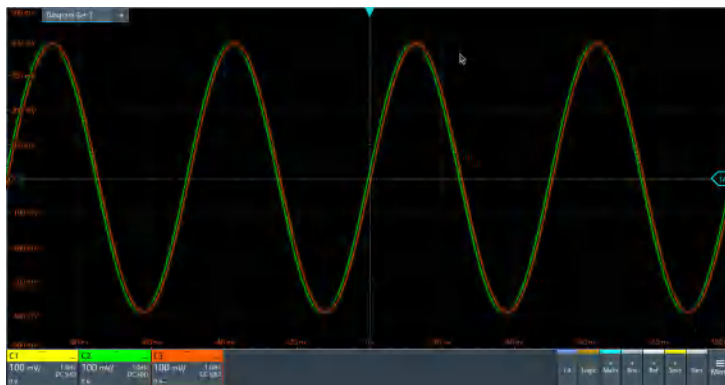

```
//Create new diagrams for C2 and C3.
//Assign sources C2 and C3 to these diagrams.
LAY:DIAG2:ENAB 1
LAY:DIAG2:SOUR C2
LAY:DIAG3:ENAB 1
LAY:DIAG3:SOUR C3
//Create new node (node 2) and assign new diagrams to that node
//Place C2 on top, C3 at bottom
LAY:NODE2:ENAB 1
LAY:NODE2:CHIL1:CONT:TYPE DIAG
LAY:NODE2:CHIL1:CONT:ID 2
LAY:NODE2:CHIL2:CONT:TYPE DIAG
LAY:NODE2:CHIL2:CONT:ID 3
LAY:NODE2:STYP VERT
//Insert node 2 into the base node (initial node)
//Diagram1 is initially located at child 1
LAY:NODE1:CHIL2:CONT:TYPE NODE
LAY:NODE1:CHIL2:CONT:ID 2
//Place both nodes side by side
LAY:NODE1:STYP HOR
```

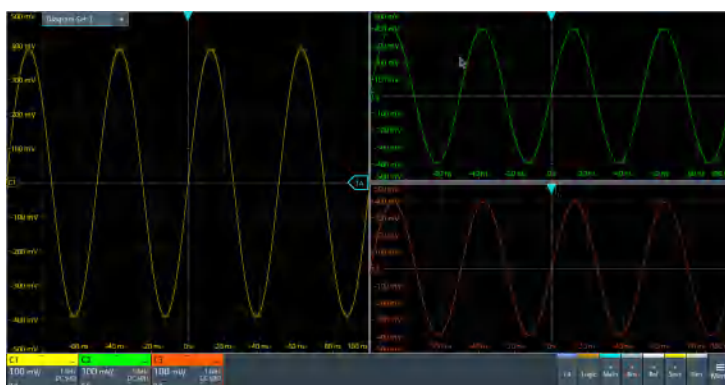

```
//Add zoom to C3. The zoom is located in diagram 3.
LAY:ZOOM:ENAB 1
LAY:ZOOM:SOUR 3
```

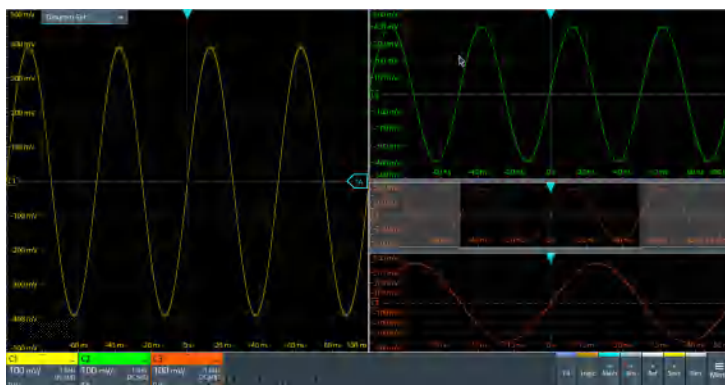

```
//Add a second layout with C1 and spectrum of C1.
//By default, the new layout is empty.
LAY2:ENAB 1
```

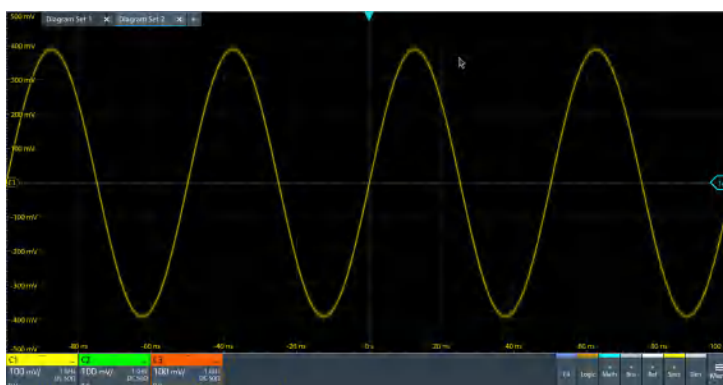

```
//Assign C1 to layout 2.
LAY2:DIAG1:SOUR C1
```

```
//Turn on spectrum of C1.
//By default, the spectrum is set below its analog source, and into the next
//free diagram (here diagram 2).
CALC:SPEC:STAT 1
CALC:SPEC:FREQ:CENT 20e6
CALC:SPEC:FREQ:SPAN 4e6
CALC:SPEC:FREQ:SCAL 15
```

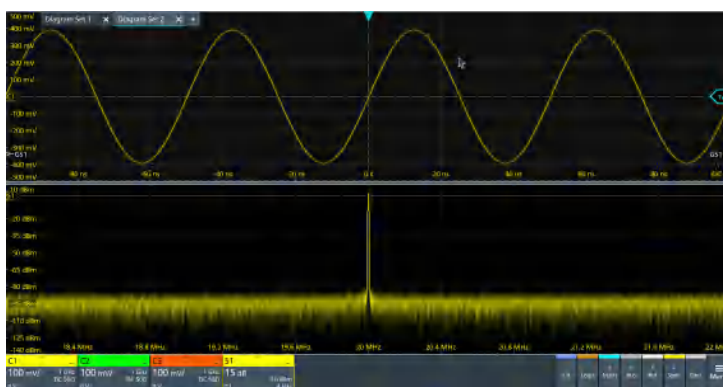

```
//Set C1 and spectrum side by side by changing the split type.
LAY2:NODE1:STYP HOR
```

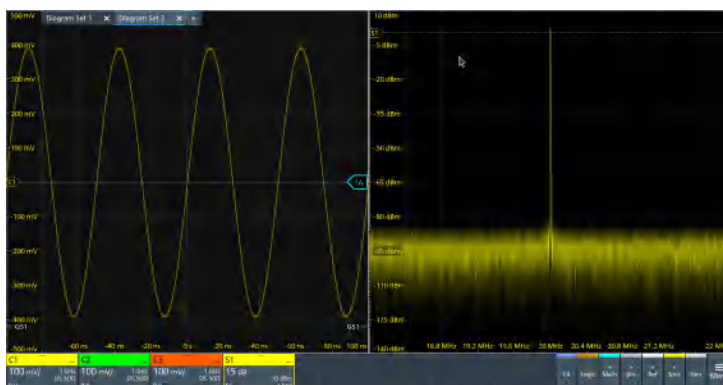

```
//Add zoom to spectrum. The zoom is located in layout 2, in diagram 2.
LAY2:ZOOM:ENAB 1
LAY2:ZOOM:SOUR 2
```

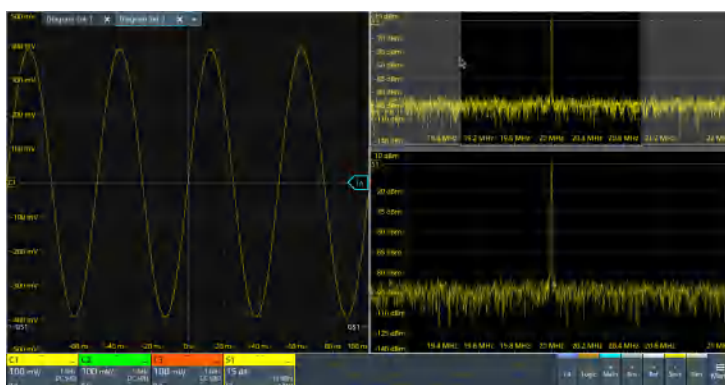

```
//Change zoom area.
LAY2:ZOOM:HOR:MODE REL
LAY2:ZOOM:HOR:REL:START 48
LAY2:ZOOM:HOR:REL:STOP 52
```

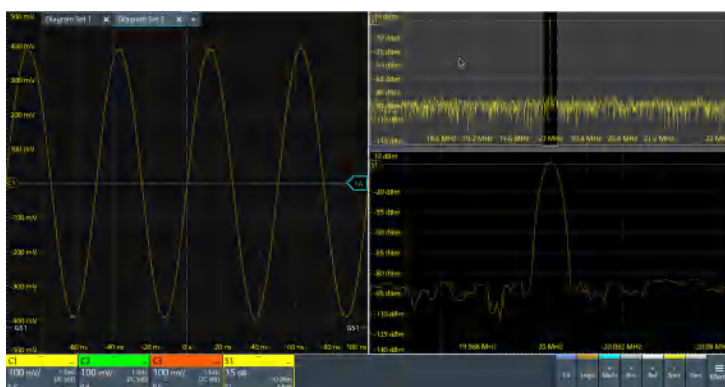

```
//Switch back to first layout (diagram set 1).
LAY1:SACT
```

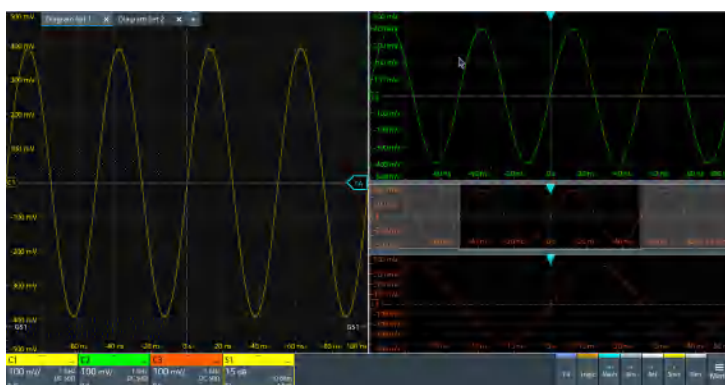

17.4.2 Saving screenshots to file

The example saves three display images in png format to the files `Print.png`, `Print_001.png`, and `Print_002.png` on USB flash drive in the directory `/run/media/usb/`. To get a correct screenshot, turn on the display first.

Command description in: [Chapter 17.11.6, "Screenshots"](#), on page 554.

In the following example *OPC prevents overlapping execution of asynchronous commands.

- ▶ Connect a USB flash drive to the instrument.

```
SYST:DISP:UPD ON
HCOP:DEST 'MMEM'
HCOP:DEV:LANG PNG
*OPC?
MMEM:NAME '/run/media/usb/'
HCOP:IMMEDIATE; *OPC?
HCOP:IMM:NEXT; *OPC?
HCOP:IMM:NEXT; *OPC?
```

17.4.3 Data transfer in roll mode

The example shows the effects of [EXPort:WAVeform:SCOPE](#) and [ACQUIRE:ROLLmode:OSCapture](#) in roll mode.

Sample rate mode and record length mode are set to AUTO, and the record length is 10 M points.

```
ACQUIRE:SRATE:MODE AUTO
ACQUIRE:POINTS:MODE AUTO
ACQUIRE:POINTS?
--> 10000000
ACQUIRE:ROLLmode:OSCapture OFF
CHANNEL:DATA:HEADER?
--> -5,4.999999,10000000,1 //10 M points of data are transferred
ACQUIRE:ROLLmode:OSCapture ON
EXPort:WAVeform:SCOPE DISP //Export of the displayed data
CHANNEL:DATA:HEADER?
--> -5,4.999999,10000000,1 //10 M points of data are transferred
EXPort:WAVeform:SCOPE ALL //Export of all data
CHANNEL:DATA:HEADER?
--> -31.702346,4.99999999,36702346,1 //36.7 M points of data are transferred
```

17.5 Common commands

Common commands are described in the IEEE 488.2 (IEC 625-2) standard. These commands have the same effect and are employed in the same way on different devices. The headers of these commands consist of "*" followed by three letters. Many common commands are related to the Status Reporting System.

Available common commands:

*CAL?	436
*CLS	436
*IDN?	436
*OPC	437
*OPT?	437
*RCL	437
*RST	437
*SAV	438
*SRE	438
*STB?	438
*TRG	438
*WAI	438

***CAL?**

Starts a self-alignment of the instrument, and then queries a status response. Return values $\neq 0$ indicate an error.

Return values:

<State>	0: no error
	1: alignment failed
	2: not aligned, e.g. init
	3: device needs longer warmup time before selfalignment can start
	4: input signal connected during selfalignment

Usage: Query only

***CLS**

Clear status

Sets the status byte (STB), the standard event register (ESR) and the `EVENT` part of the `QUESTIONABLE` and the `OPERATION` registers to zero. The command does not alter the mask and transition parts of the registers. It clears the output buffer.

Usage: Setting only

***IDN?**

Identification

Returns the instrument identification.

Return values:

<ID>	"Rohde&Schwarz,<device type>,<part number>/<serial number>,<firmware version>"
------	--

Example: Rohde&Schwarz, MXO5, 1802.1008k08/100222, 2.00.0.2
Model assignment:

Usage: Query only

Manual operation: See "[Instrument](#)" on page 70

***OPC**

Operation complete

Sets bit 0 in the event status register when all preceding commands have been executed. This bit can be used to initiate a service request. The query writes a "1" into the output buffer when all preceding commands have been executed, which is useful for command synchronization.

***OPT?**

Option identification query

Queries the options included in the instrument. For a list of all available options and their description, refer to the data sheet.

Return values:

<Options> The query returns a list of options. The options are returned at fixed positions in a comma-separated string. A zero is returned for options that are not installed.

Usage: Query only

***RCL <Number>**

Recall

Loads the instrument settings from an intermediate memory identified by the specified number. The instrument settings can be stored to this memory using the command [*SAV](#) with the associated number.

The stored instrument settings do not include waveform generator settings.

It also activates the instrument settings which are stored in a file and loaded using [MMEMoRY:LOAD:STATe](#).

***RST**

Reset

Sets the instrument to a default status. The default settings are indicated in the description of commands. Default settings are fixed, they are *not* changed by user-defined preset.

The command does not affect the waveform generator settings. To reset the generator, use [WGENerator<wg>:PRESet](#).

Usage: Setting only

***SAV** <Number>

Save

Stores the current instrument settings under the specified number in an intermediate memory. The settings can be recalled using the command ***RCL** with the associated number.

Waveform generator settings are not included.

To transfer the stored instrument settings to a file, use **MMEMory:STORe:STATe**.

***SRE** <Contents>

Service request enable

Sets the service request enable register to the indicated value. This command determines under which conditions a service request is triggered.

Parameters:

<Contents> Contents of the service request enable register in decimal form.
Bit 6 (MSS mask bit) is always 0.
Range: 0 to 255

***STB?**

Status byte query

Reads the contents of the status byte in decimal form.

Usage: Query only

***TRG**

Trigger

Triggers all actions waiting for a trigger event. In particular, ***TRG** generates a manual trigger signal. This common command complements the commands of the **TRIGger** subsystem.

***TRG** corresponds to the **INITiate:IMMediate** command.

Usage: Event

***WAI**

Wait to continue

Prevents servicing of the subsequent commands until all preceding commands have been executed and all signals have settled (see also command synchronization and ***OPC**).

Usage: Event

17.6 General remote settings

This chapter describes commands that affect many other remote commands in different applications of the instrument.

FORMat[:DATA].....	439
FORMat:BPATtern.....	440
SYSTem:DISPlay:UPDate.....	440
SYSTem:DISPlay:MESSage:STATe.....	440
SYSTem:DISPlay:MESSage[:TEXT].....	441

FORMat[:DATA] [<Format>],[<Length>]

FORMat[:DATA]? [<Format>]

Selects the data type that is used for transmission of data from analog channels, math and reference waveforms, and some measurement results from the instrument to the controlling computer.

Setting parameters:

<Length> *RST: ASCii

Parameters for setting and query:

<Format> ASCii | REAL | INT

ASCii

Data values are returned in ASCII format as a list of comma-separated values in floating point format. The length can be omitted. It is 0 which means that the instrument selects the number of digits to be returned. The query returns both values (ASC, 0).

REAL,32

The data is stored as binary data (Definite Length Block Data according to IEEE 488.2). Each waveform value is formatted in 32-Bit IEEE 754 Floating Point Format.

The schema of the result string is as follows:

#41024<value1><value2>...<value n> with:

#4 = number of digits (= 4 in the example) of the following number

1024 = number of following data bytes (= 1024 in the example)

<value> = 4-byte floating point values

For large data (≥ 1 GB), the result string starts with "#(data length)". The number inside the parentheses indicates the real data length in bytes.

INT,8 | INT,16 | INT,32

Signed integer data with length 8 bit, 16 bit, or 32 bit.

The result string has the same schema as the REAL format.

For INT,16 you can set the byte order using the command.

For digital channel data, math and histogram data, INT formats are not available.

Example: FORMat:DATA REAL, 32
 FORMat:DATA?
 REAL, 32

Usage: SCPI confirmed
 Asynchronous command

Manual operation: See "[Transfer data format](#)" on page 74

FORMat:BPATtern <BtPattFmt>

Sets the number format for remote bit pattern queries on serial protocols.

Parameters:

<BtPattFmt> DEC | HEX | OCT | BIN | ASCII | ASCii | STRG
 *RST: HEX

Usage: Asynchronous command

Manual operation: See "[Bit pattern format](#)" on page 74

SYSTem:DISPlay:UPDate <DisplayUpdate>

Defines whether the display is updated while the instrument is in the remote state. If the display is switched off, the normal GUI is replaced by a static image while the instrument is in the remote state. Switching off the display can speed up the measurement. This is the recommended state.

Parameters:

<DisplayUpdate> ON | OFF
 ON | 1: Display is shown and updated during remote control.
 OFF | 0: Display shows static image during remote control.
 *RST: OFF

Example: SYSTem:DISPlay:UPDate 1
 Switch on the display update.

Usage: Asynchronous command

SYSTem:DISPlay:MESSAge:STATe <DispMessSt>

Enables and disables the display of an additional text in remote control.

To define the text, use [SYSTem:DISPlay:MESSAge\[:TEXT\]](#).

Parameters:

<DispMessSt> ON | OFF
 *RST: OFF

Usage: Asynchronous command

SYSTem:DISPlay:MESSage[:TEXT] <DisplayMessage>

Defines an additional text that is displayed during remote control operation.

To enable the text display, use `SYSTem:DISPlay:MESSage:STATe`.

Parameters:

<DisplayMessage>

Usage: Asynchronous command

17.7 Instrument setup

- [System](#)..... 441
- [SmartGrid](#)..... 443
- [Toolbar](#)..... 448
- [Appearance](#)..... 449
- [Display](#)..... 453
- [Maintenance](#)..... 459

17.7.1 System

SYSTem:COMMunicate:NET[:HOSTname]	441
SYSTem:DATE	441
SYSTem:EXIT	442
SYSTem:FW:FILEpath	442
SYSTem:PRESet	442
SYSTem:SHUTdown	442
SYSTem:FW:START	443
SYSTem:TIME	443

SYSTem:COMMunicate:NET[:HOSTname] <Hostname>

Sets the host name of the instrument, which is required when configuring a network.

The query `SYSTem:COMMunicate:NET:HOSTname?` returns the currently defined host name.

Parameters:

<Hostname> String parameter

Usage: Asynchronous command

Manual operation: See "[Device name](#)" on page 71

SYSTem:DATE <Year>,<Month>,<Day>

Sets the date of the internal calendar.

Parameters:

<Year>	Year, to be entered as a four-digit number (including the century and millennium information) Range: 2012 to 2099 Increment: 1 *RST: 2012
<Month>	Month, 1 (January) to 12 (December) Range: 1 to 12 Increment: 1 *RST: 1
<Day>	Day, 1 to the maximum number of days in the specified month Range: 1 to 31 Increment: 1 *RST: 1

Example:

SYSTem:DATE?
Returned value: 2022,09,28

Usage:

Asynchronous command

SYSTem:EXIT

Starts the shutdown of the firmware.

Usage:

Setting only
Asynchronous command

SYSTem:FW:FILEpath <FilePath>

Sets the path and the filename of the firmware installation file.

Parameters:

<FilePath> String with path and filename

Usage:

SCPI confirmed
Asynchronous command

SYSTem:PRESet

Resets the instrument to the default state, has the same effect as *RST.

Usage:

Setting only
SCPI confirmed
Asynchronous command

Manual operation: See "[Factory preset](#)" on page 90

SYSTem:SHUTdown

Starts the shutdown of the instrument (firmware and operating system).

Usage: Setting only
Asynchronous command

SYSTem:FW:START

Starts the firmware update. Before starting, make sure that the correct path is set with `SYSTem:FW:FILEpath`.

Usage: Event
SCPI confirmed
Asynchronous command

SYSTem:TIME <Hours>,<Minutes>,<Seconds>

Returns the current time of the clock.

Parameters:

<Hours>	Range: 0 to 24 Increment: 1 *RST: 1
<Minutes>	Range: 0 to 59 Increment: 1 *RST: 1
<Seconds>	Range: 0 to 59 Increment: 1 *RST: 1

Usage: Asynchronous command

17.7.2 SmartGrid

The following `LAYout` commands configure the SmartGrid. In manual operation, you configure the SmartGrid by drag and drop.

Table 17-1: Terms and definitions of SmartGrid configuration

Term	Definition
Layout	A layout is a SmartGrid configuration. Several configurations can exist but only one configuration is active. By default, SmartGrid configurations named "Diagram Set" on the display.
Children	A child is an area where data (data table, result table) or waveforms (diagram) are displayed. Also a node can be a child (nested node).
Node	A node consists of one or two children. A node is created with one child that has content.
Diagram	A diagram displays waveforms, the graphical visualization of data.

LAYout<ly>:COUNT?	444
LAYout<ly>[:ENABLE]	444
LAYout<ly>:ACTive	444
LAYout<ly>:SACTive	445
LAYout<ly>:LABel	445
LAYout<ly>:DIAGram<da>:COUNT?	445
LAYout<ly>:DIAGram<da>[:ENABLE]	445
LAYout<ly>:DIAGram<da>:SOURce	446
LAYout<ly>:DIAGram<da>:LABel	446
LAYout<ly>:NODE<no>:COUNT?	446
LAYout<ly>:NODE<no>[:ENABLE]	447
LAYout<ly>:NODE<no>:CHILdren<o>:CONTent<p>:ID	447
LAYout<ly>:NODE<no>:CHILdren<o>:CONTent<p>:TYPE	447
LAYout<ly>:NODE<no>:RATio	448
LAYout<ly>:NODE<no>:STYPe	448

LAYout<ly>:COUNT?

Returns the number of available layouts, i.e. SmartGrid configurations. By default, they named "Diagram Set" on the display.

Suffix:

<ly> Irrelevant, omit the suffix.

Return values:

<Count> Number of SmartGrid configurations

Usage:

Query only
Asynchronous command

LAYout<ly>[:ENABLE] <State>

Creates a new SmartGrid configuration and sets it active.

Suffix:

<ly> 1...8, index of the SmartGrid layout

Parameters:

<State> ON | OFF

Example:

See [Chapter 17.4.1, "SmartGrid layout with zoom"](#), on page 430.

Usage:

Asynchronous command

LAYout<ly>:ACTive <ActiveKey>

Sets the active SmartGrid configuration. The query returns the index of the active layout.

Suffix:

<ly> Irrelevant, omit the suffix.

Parameters:

<ActiveKey> Index of the active layout

Usage: Asynchronous command

LAYout<ly>:SACTive

Activates the specified SmartGrid configuration. The command has the same effect as [LAYout<ly>:ACTive](#) but it has no query, and the active layout is specified by the suffix.

Suffix:

<ly> 1...8, index of the SmartGrid layout

Example: See [Chapter 17.4.1, "SmartGrid layout with zoom"](#), on page 430.

Usage: Setting only
Asynchronous command

LAYout<ly>:LABel <Label>

Defines a name for the specified layout (SmartGrid configuration).

Suffix:

<ly> 1...8, index of the SmartGrid layout

Parameters:

<Label> String with the layout name

Usage: Asynchronous command

LAYout<ly>:DIAGram<da>:COUNT?

Returns the number of diagrams in a specified layout.

Suffix:

<ly> 1...8, index of the SmartGrid layout

<da> Irrelevant, omit the suffix.

Return values:

<Count> Number of diagrams

Usage: Query only
Asynchronous command

LAYout<ly>:DIAGram<da>[:ENABle] <State>

Creates and displays a specified diagram in a specified layout. OFF deletes the diagram.

Suffix:

<ly> 1...8, index of the SmartGrid layout

<da> 1...8, index of the diagram

Parameters:

<State> ON | OFF

Example: See [Chapter 17.4.1, "SmartGrid layout with zoom"](#), on page 430.

Usage: Asynchronous command

LAYout<ly>:DIAGram<da>:SOURce <SignalKeys>

Assigns the waveforms to a diagram.

Suffix:

<ly> 1...8, index of the SmartGrid layout

<da> 1...8, index of the diagram

Parameters:

<SignalKeys> String with a comma-separated list of waveforms, e.g. "C1, C2, M1"

Example: See [Chapter 17.4.1, "SmartGrid layout with zoom"](#), on page 430.

Usage: Asynchronous command

LAYout<ly>:DIAGram<da>:LABel <Label>

Defines a name for the specified diagram in a specified layout.

Suffix:

<ly> 1...8, index of the SmartGrid layout

<da> 1...8, index of the diagram

Parameters:

<Label> String with the diagram name

Usage: Asynchronous command

LAYout<ly>:NODE<no>:COUNT?

Returns the maximum number of nodes that can be defined. This number is the maximum value for the node suffix.

Suffix:

<ly> 1...8, index of the SmartGrid layout

<no> Irrelevant, omit the suffix.

Return values:

<Count> Maximum value for the node suffix

Usage: Query only
Asynchronous command

LAYout<ly>:NODE<no>[:ENABLE] <State>

Creates the specified node in the specified layout. OFF deletes the node and its children.

The query returns whether the specified node exists (1) or not (0).

Suffix:

<ly> 1...8, index of the SmartGrid layout

<no> Index of the node

Parameters:

<State> ON | OFF

Example: See [Chapter 17.4.1, "SmartGrid layout with zoom"](#), on page 430.

Usage: Asynchronous command

LAYout<ly>:NODE<no>:CHILdren<o>:CONTent<p>:ID <ID>

Sets the content ID, the number of the specified content type.

For example, the "Diagram5" has Type=DIAGRAM and ID=5.

Suffix:

<ly> 1...8, index of the SmartGrid layout

<no> Index of the node

<o> 1 | 2, child index

<p> Irrelevant, omit the suffix.

Parameters:

<ID> Numeric value

Example: See [Chapter 17.4.1, "SmartGrid layout with zoom"](#), on page 430.

Usage: Asynchronous command

LAYout<ly>:NODE<no>:CHILdren<o>:CONTent<p>:TYPE <Type>

Sets the content type for a specified child in a specified node: diagram, result table, another node, or empty.

For example, the "Diagram5" has Type=DIAGRAM and ID=5.

Suffix:

<ly> 1...8, index of the SmartGrid layout

<no> Index of the node

<o> 1 | 2, child index

<p> Irrelevant, omit the suffix.

Parameters:

<Type> NONE | DIAG | DIAGRAM | RES | RESULT | NODE
 DIAG = DIAGRAM, RES = RESULT
 *RST: NONE

Example: See [Chapter 17.4.1, "SmartGrid layout with zoom"](#), on page 430.

Usage: Asynchronous command

LAYout<ly>:NODE<no>:RATio <SplitRatio>

Sets the size ratio of the two children in the specified node.

Suffix:

<ly> 1...8, index of the SmartGrid layout
 <no> Index of the node

Parameters:

<SplitRatio> Size ratio of the children. 0.5 assigns 50% of the node size to each child. 0.3 assigns 30% to child 1% and 70% to child 2.
 Range: 0 to 1
 Increment: 0.0001
 *RST: 0.5

Usage: Asynchronous command

LAYout<ly>:NODE<no>:STYPe <SplitType>

Creates a second child (e.g. diagram) in the node if only one child exists, and sets the splitting of the node. If two children exist, only the splitting is set.

Suffix:

<ly> 1...8, index of the SmartGrid layout
 <no> Index of the node

Parameters:

<SplitType> HOR | HORIZONTAL | VERT | VERTICAL
 HOR = HORIZONTAL, VERT = VERTICAL
 *RST: NONE

Example: See [Chapter 17.4.1, "SmartGrid layout with zoom"](#), on page 430.

Usage: Asynchronous command

17.7.3 Toolbar

DISPlay:TOOLbar:COUNt?	449
DISPlay:TOOLbar:DESelect	449
DISPlay:TOOLbar:REStore	449

DISPlay:TOOLbar:COUNT?

Returns the number of tools that are currently assigned to the toolbar.

Return values:

<ToolCount>	Range:	0 to 100
	Increment:	1
	*RST:	8

Usage: Query only
Asynchronous command

DISPlay:TOOLbar:DESelect

Removes all tools from the toolbar.

Usage: Setting only
SCPI confirmed
Asynchronous command

DISPlay:TOOLbar:REStore

Resets the toolbar to the factory configuration.

Usage: Setting only
SCPI confirmed
Asynchronous command

17.7.4 Appearance

- [Waveform colors](#)..... 449
- [Grid appearance](#)..... 451
- [Dialog appearance](#)..... 452
- [Peak list appearance](#)..... 453

17.7.4.1 Waveform colors

- | | |
|---|-----|
| DISPlay:COLor:SIGNal:CATalog? | 449 |
| DISPlay:COLor:SIGNal:COLor | 450 |
| DISPlay:COLor:SIGNal:ASSign | 450 |
| DISPlay:COLor:SIGNal:USE | 450 |
-

DISPlay:COLor:SIGNal:CATalog?

Returns a comma-separated list of valid signal names. The signal names are needed in other DISPlay:COLor commands to set the <Signal> parameter.

Usage: Query only
Asynchronous command

DISPlay:COLor:SIGNal:COLor <Signal>,<Value>

Sets the color of the selected waveform.

Parameters:

<Value> Decimal value of the ARGB color. Use the color dialog box on the instrument to get the hex value of the color, and convert the hex value to a decimal value.
0 is fully transparent black.
4278190080 (dec) = FF000000 (hex) is opaque black.
4294967295 (dec) = FFFFFFFF (hex) is opaque white.
To reset the color to its default, use
DISPlay:COLor:SIGNal:COLor <Signal>,DEF.

Setting parameters:

<Signal> Signal name as returned by [DISPlay:COLor:SIGNal:CATalog?](#).

Usage: Asynchronous command

Manual operation: See "[Color](#)" on page 79

DISPlay:COLor:SIGNal:ASSign <Signal>,<ColorTable>

Assigns a color table to the source waveform instead of a dedicated color.

Parameters:

<ColorTable> String with the name of the color table

Setting parameters:

<Signal> Signal name as returned by [DISPlay:COLor:SIGNal:CATalog?](#).

Usage: Asynchronous command

Manual operation: See "[Assigned color table](#)" on page 79

DISPlay:COLor:SIGNal:USE <Signal>,<State>

If enabled, the selected waveform is displayed according to its assigned color table.

If disabled, the selected color is displayed, and the intensity of the signal color varies according to the cumulative occurrence of the values.

Parameters:

<State> ON | OFF

Setting parameters:

<Signal> Signal name as returned by [DISPlay:COLor:SIGNal:CATalog?](#).

Usage: Asynchronous command

Manual operation: See "[Use color table](#)" on page 79

17.7.4.2 Grid appearance

DISPlay:DIAGram:CROShair.....	451
DISPlay:DIAGram:FINegrid.....	451
DISPlay:DIAGram:GRID.....	451
DISPlay:DIAGram:LABels.....	451
DISPlay:DIAGram:YFIXed.....	452

DISPlay:DIAGram:CROShair <Crosshair>

If selected, a crosshair is displayed in the diagram area. A crosshair allows you to select a specific data point by its coordinates.

Parameters:

<Crosshair> ON | OFF
 *RST: ON

Usage: Asynchronous command

Manual operation: See "[Show crosshair](#)" on page 81

DISPlay:DIAGram:FINegrid <ShowFineScale>

If selected, the crosshair is displayed as a ruler with scale markers. If disabled, the crosshair is shown as dashed lines.

Parameters:

<ShowFineScale> ON | OFF
 *RST: ON

Usage: Asynchronous command

Manual operation: See "[Show fine grid scale](#)" on page 81

DISPlay:DIAGram:GRID <Show>

If selected, a grid is displayed in the diagram area. A grid helps you associate a specific data point to its exact value on the x- or y-axis.

Parameters:

<Show> ON | OFF
 *RST: ON

Usage: Asynchronous command

Manual operation: See "[Show grid](#)" on page 81

DISPlay:DIAGram:LABels <ShowLabels>

If selected, labels mark values on the x- and y-axes in specified intervals in the diagram.

Parameters:

<ShowLabels> ON | OFF
 *RST: ON

Usage: Asynchronous command

Manual operation: See ["Show labels"](#) on page 81

DISPlay:DIAGram:YFIXed <YGridFixed>

If enabled, the horizontal grid lines remain in their position when the position of the curve is changed. Only the values at the grid lines are adapted.

Fixed horizontal grid lines correspond to the behavior of traditional oscilloscopes.

Parameters:

<YGridFixed> ON | OFF
 *RST: ON

Usage: Asynchronous command

Manual operation: See ["Keep Y-grid fixed"](#) on page 82

17.7.4.3 Dialog appearance

DISPlay:DIALog:FONTsize	452
DISPlay:DIALog:TRANsparency	452
DISPlay:RESult:FONTsize	453

DISPlay:DIALog:FONTsize <DialogFontSize>

Sets the font size of the text in dialog boxes.

Parameters:

<DialogFontSize> Range: 12 to 30
 Increment: 1
 *RST: 19

Usage: Asynchronous command

Manual operation: See ["Font size \(Dialog\)"](#) on page 82

DISPlay:DIALog:TRANsparency <DialogTransp>

Sets the transparency of the dialog box background. For high transparency values, you can see the waveform display in the background, and possibly check the effect of the changed setting. For lower transparency values, readability in the dialog box improves.

Parameters:

<DialogTransp> Range: 0 to 70
 Increment: 1
 *RST: 0

Usage: Asynchronous command
Manual operation: See "[Transparency \(Dialog\)](#)" on page 83

DISPlay:RESult:FONTsize <ResultFontSize>

Sets the font size of the text in result tables.

Parameters:

<ResultFontSize> Range: 8 to 30
 Increment: 1
 *RST: 19

Usage: Asynchronous command
Manual operation: See "[Font size \(Result dialog\)](#)" on page 83

17.7.4.4 Peak list appearance

[CALCulate:SPECTrum<sp>:PLISt:LABel:BORDER](#).....453

CALCulate:SPECTrum<sp>:PLISt:LABel:BORDER <LabelBorder>

Defines the layout of the labels, full border or none.

Suffix:

<sp> 1...4, index of the spectrum

Parameters:

<LabelBorder> NOBorder | FULL
 FULL: Full border
 *RST: FULL

Usage: Asynchronous command
Manual operation: See "[Frame type](#)" on page 83

17.7.5 Display

- [Persistence](#)..... 453
- [Signal](#)..... 455
- [Backlight](#)..... 455
- [Clear results](#)..... 456
- [Save/Recall](#)..... 456

17.7.5.1 Persistence

[DISPlay:PERsistence:INFinite](#).....454
[DISPlay:PERsistence:RESet](#)..... 454
[DISPlay:PERsistence:TIME](#).....454
[DISPlay:PERsistence\[:STATE\]](#).....454

DISPlay:PERSistence:INFinite <State>

If infinite persistence is enabled, each new waveform point remains on the screen until this option is disabled. Use infinite persistence to display rare events in the signal.

Parameters:

<State> ON | OFF
 *RST: OFF

Usage: Asynchronous command

Manual operation: See "[Infinite persistence](#)" on page 85

DISPlay:PERSistence:RESet

Resets the display, removing persistent all waveform points.

Usage: Setting only
 Asynchronous command

Manual operation: See "[Reset](#)" on page 85

DISPlay:PERSistence:TIME <Time>

Sets a time factor that controls how long the waveforms points fade away from the display. Thus, the R&S MXO 5 emulates the persistence of analog phosphor screens.

Parameters:

<Time> Range: 0.05 to 50
 Increment: 0.05
 *RST: 0.05
 Default unit: s

Usage: Asynchronous command

Manual operation: See "[Time](#)" on page 85

DISPlay:PERSistence[:STATE] <State>

If enabled, each new data point in the diagram area remains on the screen for the duration defined using [DISPlay:PERSistence:TIME](#), or as long as [DISPlay:PERSistence:INFinite](#) is enabled.

If disabled, the signal value is only displayed as long as it actually occurs.

Parameters:

<State> ON | OFF
 *RST: ON

Usage: Asynchronous command

Manual operation: See "[Enable](#)" on page 85

17.7.5.2 Signal

DISPlay:INTensity.....	455
DISPlay:DIAGram:STYLE.....	455

DISPlay:INTensity <Intensity>

The intensity determines the strength of the waveform line in the diagram. Enter a percentage between 0 (not visible) and 100% (strong). The default value is 50%.

Parameters:

<Intensity>	Range: 0 to 100
	Increment: 1
	*RST: 50
	Default unit: %

Usage: Asynchronous command

Manual operation: See "[Intensity](#)" on page 86

DISPlay:DIAGram:STYLE <Style>

Selects the style in which the waveform is displayed.

Parameters:

<Style> VECTors | DOTS

VECTors

The individual data points are connected by a line.

DOTS

Only the individual data points are displayed.

*RST: VECTors

Usage: Asynchronous command

Manual operation: See "[Waveform style](#)" on page 86

17.7.5.3 Backlight

| | |
|------------------------------------|-----|
| DISPlay:BACKlight[:BRIGtness]..... | 455 |
| DISPlay:BACKlight:DIMMING..... | 456 |

DISPlay:BACKlight[:BRIGtness] <LCDIntensity>

Sets the background luminosity of the touchscreen.

Parameters:

| | |
|----------------|-----------------|
| <LCDIntensity> | Range: 5 to 100 |
| | Increment: 1 |
| | *RST: 90 |
| | Default unit: % |

Usage: Asynchronous command

Manual operation: See "Brightness" on page 87

DISPlay:BACKlight:DIMMing <UsrActivityTout>

Selects a time, after which the monitor brightness is reduced, if the instrument was inactive. Remote control of the instrument is also considered as an activity.

Parameters:

<UsrActivityTout> OFF | T1Minute | T2Minutes | T3Minutes | T5Minutes |
T10Minutes | T15Minutes | T20Minutes | T25Minutes |
T30Minutes | T45Minutes | T1Hour | T2Hours | T3Hours |
T4Hours
*RST: OFF

Usage: Asynchronous command

Manual operation: See "Dimm on user inactivity" on page 87

17.7.5.4 Clear results

DISPlay:CLR

Deletes all measurement results including all waveforms and statistics.

Usage: Setting only
Asynchronous command

Manual operation: See "Clear" on page 58

17.7.5.5 Save/Recall

Autonaming

| | |
|-------------------------------------|-----|
| MMEMory:AUTonaming:PREFix..... | 456 |
| MMEMory:AUTonaming:TIME..... | 456 |
| MMEMory:AUTonaming:INDex..... | 456 |
| MMEMory:AUSave:ENABle..... | 457 |
| MMEMory:AUSave:INTerval..... | 457 |
| MMEMory:AUTonaming:USERtext..... | 457 |
| MMEMory:AUTonaming:DEFaultpath..... | 458 |
| MMEMory:AUTonaming:RESall..... | 458 |
| MMEMory:AUTonaming:RESPath..... | 458 |
| MMEMory:AUTonaming:TEXT..... | 458 |

MMEMory:AUTonaming:PREFix <MainNmeStemSt>

MMEMory:AUTonaming:TIME <DateTIme>

MMEMory:AUTonaming:INDex <NameIndex>

Includes or excludes the prefix/ date/time /index in the filename pattern for automatic filename generation. This name is used as the default filename.

The prefix indicates the type of data that is saved, for example, RefCurve, Settings.

Parameters:

<NameIndex> ON | OFF
*RST: ON

Usage: Asynchronous command

Manual operation: See "[Index](#)" on page 97

MMEMory:AUSave:ENABLE <EnableAutosave>

Enables the automatic saving of the waveform. You can set the autosave interval with [MMEMory:AUSave:INTERval](#).

Parameters:

<EnableAutosave> ON | OFF
*RST: ON

Usage: Asynchronous command

Manual operation: See "[Enable autosave](#)" on page 97

MMEMory:AUSave:INTERval <AutosaveIntvl>

Defines the time interval for the automatic saving of the waveform, if [MMEMory:AUSave:ENABLE](#) is set to ON.

Parameters:

<AutosaveIntvl> Range: 1 to 360000
Increment: 1
*RST: 300
Default unit: s

Usage: Asynchronous command

Manual operation: See "[Enable autosave](#)" on page 97

MMEMory:AUTonaming:USERtext <NmeStringSt>

If enabled, inserts the specified user text after the prefix.

You can define the text with [MMEMory:AUTonaming:TEXT](#).

Parameters:

<NmeStringSt> ON | OFF
*RST: OFF

Usage: Asynchronous command

Manual operation: See "[User text](#)" on page 96

MMEMory:AUTonaming:DEFaultpath <Path>

Sets the path where data and settings files are stored. On the instrument, all user data is written to `home/storage/userData`. You can create subfolders in this folder.

Parameters:

<Path> String parameter

Usage: Asynchronous command

Manual operation: See "[Default path for all file operations](#)" on page 97

MMEMory:AUTonaming:RESall

Resets all autonaming settings to the default value, including the path.

Usage: Setting only
Asynchronous command

Manual operation: See "[Reset path](#)" on page 97

MMEMory:AUTonaming:RESPath

Resets the path for file operations to the factory default path.

Usage: Setting only
Asynchronous command

Manual operation: See "[Reset path](#)" on page 97

MMEMory:AUTonaming:TEXT <NameString>

Defines a text that can be included in the autonaming pattern.

Parameters:

<NameString> String parameter

Usage: Asynchronous command

Manual operation: See "[User text](#)" on page 96

CSV export

EXPort:RESult:DELimiter <Delimiter>

Selects the list separator symbol from a list. Available are semicolon, comma, space, tab and colon.

Parameters:

<Delimiter> SEMICOLON | COMMA | SPACE | TAB | COLON
*RST: COMMA

Manual operation: See "[CSV delimiter](#)" on page 98

17.7.6 Maintenance

| | |
|---------------------|-----|
| CALibration:DATE? | 459 |
| CALibration:TIME? | 459 |
| CALibration:RESult? | 459 |
| SERVice:REPort | 459 |
| SYSTem:APUP | 460 |

CALibration:DATE?

Returns the date of the last self-alignment.

Return values:

<Date>

Usage: Query only
Asynchronous command

Manual operation: See ["Date, Time, Overall alignment state"](#) on page 93

CALibration:TIME?

Returns the time of the last self-alignment.

Return values:

<Time>

Usage: Query only
Asynchronous command

Manual operation: See ["Date, Time, Overall alignment state"](#) on page 93

CALibration:RESult?

Returns the result of the last self-alignment and the current alignment status. In remote mode, *CAL? provides more detailed information.

Return values:

<ResultState> PASSEd | FAILed | NOALigndata
*RST: FAILed

Usage: Query only
Asynchronous command

Manual operation: See ["Date, Time, Overall alignment state"](#) on page 93

SERVice:REPort

Creates a service report.

The service report is a ZIP file with a complete bug report, all relevant setup information, reporting and log files, alignment files, and the instrument configuration.

If a USB flash drive is connected, the report is saved on the USB flash drive. Otherwise, the report is saved in the user data folder `/home/storage/userData`.

Usage: Event
Asynchronous command

Manual operation: See ["Create report"](#) on page 95

SYSTem:APUP <AutoPowerUp>

If enabled, the instrument powers up automatically when it is connected to the mains voltage.

Parameters:
<AutoPowerUp> ON | OFF
*RST: ON

Usage: Asynchronous command

Manual operation: See ["Auto power up"](#) on page 94

17.8 Acquisition and setup

17.8.1 Starting and stopping acquisition

| | |
|---------------------------------|-----|
| RUNCont | 460 |
| RUN | 460 |
| RUNSingle | 460 |
| SINGle | 460 |
| STOP | 461 |

RUNCont **RUN**

Starts the continuous acquisition.

Usage: Setting only
Asynchronous command

Manual operation: See ["Run/Stop"](#) on page 107

RUNSingle **SINGle**

Starts a defined number of acquisition cycles. The number of cycles is set with [ACquire:COUNT](#).

Usage: Setting only
Asynchronous command

Manual operation: See "Run Single" on page 107

STOP

Stops the running acquisition.

Usage: Event
Asynchronous command

Manual operation: See "Run/Stop" on page 107

17.8.2 Horizontal setup

| | |
|-----------------------------------|-----|
| AUToscale..... | 461 |
| TIMEbase:SCALE..... | 461 |
| TIMEbase:RANGe..... | 461 |
| TIMEbase:DIVisions?..... | 462 |
| TIMEbase:HORizontal:POSition..... | 462 |
| TIMEbase:REFerence..... | 462 |

AUToscale

Performs an autoset process: analyzes the enabled channel signals, and obtains appropriate horizontal, vertical, and trigger settings to display stable waveforms.

Rohde & Schwarz does not recommend using the autoset in remote control. To adjust the oscilloscope remotely, especially for automated testing applications, use the remote commands that adjust the horizontal, vertical and trigger settings.

Usage: Event
Asynchronous command

TIMEbase:SCALE <TimebaseScale>

Sets the horizontal scale, the time per division, for all waveforms in the time domain, for example, channel and math waveforms.

Parameters:

<TimebaseScale> Range: 200E-12 to 10E3
 Increment: 1E-12
 *RST: 20E-9
 Default unit: s/div

Usage: Asynchronous command

Manual operation: See "Time scale" on page 101

TIMEbase:RANGe <TimebaseRange>

Sets the time of one acquisition, which is the time across the 10 divisions of the diagram: *Acquisition time = Time scale * 10 divisions.*

Parameters:

<TimebaseRange> Range: Device specific to Device specific
 Increment: 1E-12
 *RST: Device specific
 Default unit: s

Usage: Asynchronous command

Manual operation: See "[Timebase range](#)" on page 101

TIMEbase:DIVisions?

Returns the number of horizontal divisions on the screen. The number cannot be changed.

Return values:

<HorizDivCnt> *RST: 10

Usage: Query only
 Asynchronous command

TIMEbase:HORizontal:POSition <Position>

Defines the time distance between the reference point and the trigger point, which is the zero point of the diagram. The horizontal position is also known as trigger offset.

Parameters:

<Position> Range: Device specific to 1E+26
 Increment: 1E-12
 *RST: 0
 Default unit: s

Usage: Asynchronous command

Manual operation: See "[Position](#)" on page 101

TIMEbase:REFerence <RescaleCtrPos>

Sets the position of the reference point in % of the screen. It defines which part of the waveform is shown.

Parameters:

<RescaleCtrPos> Range: 0 to 100
 Increment: 1
 *RST: 50
 Default unit: %

Usage: Asynchronous command

Manual operation: See "[Reference point](#)" on page 102

17.8.3 Roll mode

| | |
|---------------------------------|-----|
| TIMebase:ROLL:ENABLE..... | 463 |
| TIMebase:ROLL:MTIME..... | 463 |
| ACQuire:ROLLmode:OSCapture..... | 463 |
| ACQuire:ROLLmode:POINTS?..... | 464 |
| TIMebase:ROLL:STATe?..... | 464 |

TIMebase:ROLL:ENABLE <Mode>

Selects, if the roll mode is set automatically by the instrument or if it is turned off.

Parameters:

<Mode> AUTO | OFF
 *RST: AUTO

Usage: Asynchronous command

Manual operation: See "[Mode](#)" on page 103

TIMebase:ROLL:MTIME <MinAcquTime>

Sets the minimum acquisition time for automatic start of the roll mode.

Parameters:

<MinAcquTime> Range: 0.5 to 100000
 Increment: 1
 *RST: 2
 Default unit: s

Usage: Asynchronous command

Manual operation: See "[Start roll time](#)" on page 103

ACQuire:ROLLmode:OSCapture <OffScreenCapture>

If enabled, the analyzable waveform in roll mode is extended. Samples that arrive the left edge of the display are kept, they are moved to the invisible area on the left.

Parameters:

<OffScreenCapture> ON | OFF
 *RST: OFF

Example: See [Chapter 17.4.3, "Data transfer in roll mode"](#), on page 435.

Usage: Asynchronous command

Manual operation: See "[Off screen capture](#)" on page 103

ACQuire:ROLLmode:POINts?

Returns the record length of the roll mode. In roll mode, the complete record is always captured, independently of the displayed waveform. To process and analyze the complete roll waveform, enable [ACQuire:ROLLmode:OSCapture](#).

Return values:

<RecordLength> Range: 0 to 18446744073709551615
 Increment: 1
 *RST: 0
 Default unit: pts

Usage: Query only
 Asynchronous command

Manual operation: See "[Off screen capture](#)" on page 103

TIMEbase:ROLL:STATe?

Returns the status of the roll mode.

Return values:

<State> ON | OFF
 *RST: OFF

Usage: Query only
 Asynchronous command

Manual operation: See "[Mode](#)" on page 103

17.8.4 Vertical setup

The channel suffix <ch> selects the input channel that is affected by the command.

| | |
|--|-----|
| CHANnel<ch>:STATe | 464 |
| CHANnel<ch>:SCALE | 465 |
| CHANnel<ch>:RANGE | 465 |
| CHANnel<ch>:OFFSet | 465 |
| CHANnel<ch>:POSition | 466 |
| CHANnel<ch>:COUPling | 466 |
| CHANnel<ch>:INVert | 467 |
| CHANnel<ch>:SKEW:TIME | 467 |
| CHANnel<ch>:BANDwidth | 468 |
| CHANnel<ch>:EATScale | 468 |
| CHANnel<ch>:EATTenuation | 468 |
| CHANnel<ch>:IMPedance | 469 |

CHANnel<ch>:STATe <State>

Switches the selected channel signal on or off.

Suffix:
 <ch> 1 to 8, depending on instrument model. Index of the analog channel.

Parameters:
 <State> ON | OFF
 *RST: OFF

Usage: Asynchronous command

Manual operation: See "[Show channel](#)" on page 115

CHANnel<ch>:SCALE <Scale>

Sets the vertical scale, which defines the displayed amplitude of the selected waveform.

Suffix:
 <ch> 1 to 8, depending on instrument model. Index of the analog channel.

Parameters:
 <Scale> Range: 0.001 to 1
 Increment: 0.001
 *RST: 0.05
 Default unit: Depends on the connected probe

Usage: Asynchronous command

Manual operation: See "[\[Scale\]](#)" on page 39

CHANnel<ch>:RANGe <Range>

Sets the voltage range across the 10 vertical divisions of the diagram. The command is an alternative to [CHANnel<ch>:SCALE](#).

Suffix:
 <ch> 1 to 8, depending on instrument model. Index of the analog channel.

Parameters:
 <Range> Range: 0.01 to 10
 Increment: 0.01
 *RST: 0.5
 Default unit: V/div

Usage: Asynchronous command

CHANnel<ch>:OFFSet <Offset>

Sets the offset voltage, which corrects an offset-affected signal. The vertical center of the selected channel is shifted by the offset value and the signal is repositioned within the diagram.

Suffix:
 <ch> 1 to 8, depending on instrument model. Index of the analog channel.

Parameters:
 <Offset> Range: -1 to 1
 Increment: 0.01
 *RST: 0
 Default unit: V

Usage: Asynchronous command

Manual operation: See "[Position]" on page 39

CHANnel<ch>:POSition <Position>

Moves the selected signal up or down in the diagram. While the offset sets a voltage, position is a graphical setting given in divisions. The visual effect is the same as for offset.

Suffix:
 <ch> 1 to 8, depending on instrument model. Index of the analog channel.

Parameters:
 <Position> Positive values move up the waveform, negative values move it down.
 Range: -5 to 5
 Increment: 0.02
 *RST: 0
 Default unit: div

Usage: Asynchronous command

Manual operation: See "[Position]" on page 39

CHANnel<ch>:COUPling <Value>

Sets the connection of the channel signal, i.e. the input impedance (coupling) and a filter (termination). The command determines what part of the signal is used for waveform analysis and triggering.

Suffix:
 <ch> 1 to 8, depending on instrument model. Index of the analog channel.

Parameters:
 <Value> DC | DCLimit | AC

DC

Connection with 50 Ω termination, passes both DC and AC components of the signal.

DCLimit

Connection with 1 M Ω termination, passes both DC and AC components of the signal.

AC

Connection with 1 M Ω termination through DC capacitor, removes DC and very low-frequency components. The waveform is centered on zero volts.

Usage: Asynchronous command

Manual operation: See "[Coupling](#)" on page 116

CHANnel<ch>:INVert <InvertChannel>

Turns the inversion of the signal amplitude on or off. To invert means to reflect the voltage values of all signal components against the ground level.

Suffix:

<ch> 1 to 8, depending on instrument model. Index of the analog channel.

Parameters:

<InvertChannel> ON | OFF
 ON: inverted waveform
 OFF: normal waveform
 *RST: OFF

Usage: Asynchronous command

Manual operation: See "[Invert channel](#)" on page 116

CHANnel<ch>:SKEW:TIME <Offset>

Sets a skew value to compensate for the delay of the measurement setup or from the circuit specifics that the instrument cannot compensate automatically. It affects only the selected input channel.

Suffix:

<ch> 1 to 8, depending on instrument model. Index of the analog channel.

Parameters:

<Offset> Range: -1E-07 to 1E-07
 Increment: 1E-12
 *RST: 0
 Default unit: s

Usage: Asynchronous command

Manual operation: See "[Skew](#)" on page 117

CHANnel<ch>:BANDwidth <BandwidthLimit>

Sets the bandwidth limit. The specified bandwidth indicates the range of frequencies that the instrument can acquire and display accurately with less than 3 dB attenuation. Frequencies above the limit are removed from the signal, and noise is reduced.

Suffix:

<ch> 1 to 8, depending on instrument model. Index of the analog channel.

Parameters:

<BandwidthLimit> FULL | B2G | B1G5 | B1G | B700 | B500 | B350 | B200 | B100 | B50 | B20

FULL

Sets the bandwidth to the maximum bandwidth of the instrument. Bandwidth extension options are considered.

B700 | B500 | B350 | B200 | B100 | B50 | B20

Sets a bandwidth limit lower than the maximum. The number indicates the bandwidth limit in MHz.

B1G5 | B1G

Sets the bandwidth limit to 1500 MHz or 1000 MHz if these values are lower than the maximum.

*RST: FULL

Usage: Asynchronous command

Manual operation: See "[Bandwidth](#)" on page 117

CHANnel<ch>:EATScale <ExtAttScI>

Sets the attenuation scale for an external divider: linear or logarithmic.

Suffix:

<ch> 1 to 8, depending on instrument model. Index of the analog channel.

Parameters:

<ExtAttScI> LIN | LOG

*RST: LIN

Usage: Asynchronous command

Manual operation: See "[External Attenuation: Scale, Attenuation](#)" on page 119

CHANnel<ch>:EATTenuation <ExtAtt>

Consider a voltage divider that is part of the DUT before the measuring point. The external attenuation is included in the measurement, and the instrument shows the results that would be measured before the divider. External attenuation can be used with all probes.

Suffix:
 <ch> 1 to 8, depending on instrument model. Index of the analog channel.

Parameters:
 <ExtAtt> Values depend on the selected scale ([CHANnel<ch>:EATScale](#) on page 468) and the unit of the waveform. See "[External Attenuation: Scale, Attenuation](#)" on page 119. Limits below are for linear scale.
 Range: 0.005 to 1000000
 Increment: 0.01
 *RST: 1

Usage: Asynchronous command

Manual operation: See "[External Attenuation: Scale, Attenuation](#)" on page 119

CHANnel<ch>:IMPedance <Impedance>

Sets the impedance of the connected probe for power calculations and measurements.

Suffix:
 <ch> 1 to 8, depending on instrument model. Index of the analog channel.

Parameters:
 <Impedance> Range: 0.1 to 100000
 Increment: 1
 *RST: 50
 Default unit: Ω

Usage: Asynchronous command

Manual operation: See "[Impedance](#)" on page 119

17.8.5 Waveform data export

To set the export data format, see [FORMat \[:DATA\]](#).

[CHANnel<ch>\[:WAVeform<wf>\]:DATA:HEADer?](#)..... 469
[CHANnel<ch>\[:WAVeform<wf>\]:DATA\[:VALues\]?](#)..... 470

CHANnel<ch>[:WAVeform<wf>]:DATA:HEADer?

Returns the header of channel waveform data. The header contains attributes of the waveform.

Table 17-2: Header data

| Position | Meaning | Example |
|----------|-------------|--------------------------|
| 1 | XStart in s | -9.477E-008 = - 94,77 ns |
| 2 | XStop in s | 9.477E-008 = 94,77 ns |

| Position | Meaning | Example |
|----------|---|---------|
| 3 | Record length of the waveform in Samples | 200000 |
| 4 | Number of values per sample interval. For most waveforms, the result is 1. For peak detect and envelope waveforms, it is 2. If the number is 2, the number of returned values is twice the number of samples (record length). | 1 |

Suffix:

<ch> 1 to 8, depending on instrument model. Index of the analog channel.

<wf> 1, can be omitted

Example:

```
CHAN1:WAV1:DATA:HEAD?
-9.477E-008,9.477E-008,200000,1
```

Usage:

Query only
Asynchronous command

CHANnel<ch>[:WAVEform<wf>]:DATA[:VALues]? [<Offset>],[<Length>]

Returns the data of the channel waveform points for transmission from the instrument to the controlling computer. The data can be used in MATLAB, for example.

Without parameters, the complete waveform is retrieved. Using the offset and length parameters, data can be retrieved in smaller portions, which makes the command faster. If you send only one parameter, it is interpreted as offset, and the data is retrieved from offset to the end of the waveform.

To set the export format, use [FORMat \[: DATA \]](#) on page 439.

Suffix:

<ch> 1 to 8, depending on instrument model. Index of the analog channel.

<wf> 1, can be omitted

Query parameters:

<Offset> Number of offset waveform samples to be skipped.
Range: 0 to m. Limit: $n + m \leq \text{record length}$

<Length> Number of waveform points to be retrieved.
Range: 1 to n. Limit: $n + m \leq \text{record length}$

Return values:

<Data> List of values according to the format and content settings.

Example:

```
Retrieve the complete channel 1 waveform, only Y-values:
FORM ASC
CHAN1:WAV1:DATA?
<-- -0.125000,-0.123016,-0.123016,-0.123016,-0.123016,-0.123016,...
```

- Example:** Retrieve the first 10 values of the waveform:
 CHANnel:WAVeform:DATA:VALues? 0,10
 <-- -0.10079051554203,-0.098814234137535,-0.098814234137535,
 -0.096837945282459,-0.094861663877964,-0.094861663877964,
 -0.092885382473469,-0.090909093618393,-0.090909093618393,
 -0.088932812213898
- Example:** Skip 5 samples and retrieve the next 5 samples:
 CHANnel:WAVeform:DATA:VALues? 5,5
 <-- -0.094861663877964,-0.092885382473469,-0.090909093618393,
 -0.090909093618393,-0.088932812213898
- Usage:** Query only
 Asynchronous command

17.8.6 Acquisition setup

| | |
|------------------------|-----|
| ACQUIRE:AVAILABLE? | 471 |
| ACQUIRE:AVERAGE? | 471 |
| ACQUIRE:COUNT | 472 |
| ACQUIRE:CURRENT? | 472 |
| ACQUIRE:INTERPOLATE | 472 |
| ACQUIRE:POINTS[:VALUE] | 473 |
| ACQUIRE:POINTS:ARATE? | 473 |
| ACQUIRE:POINTS:MAXIMUM | 473 |
| ACQUIRE:POINTS:MODE | 473 |
| ACQUIRE:RESOLUTION | 474 |
| ACQUIRE:SRATE[:VALUE] | 474 |
| ACQUIRE:SRATE:MINIMUM | 475 |
| ACQUIRE:SRATE:MODE | 475 |
| ACQUIRE:SRREAL | 475 |
| ACQUIRE:TYPE | 475 |

ACQUIRE:AVAILABLE?

Number of acquisitions that is saved in the memory and available for history viewing. It is also the number of acquisitions in a fast segmentation acquisition series.

Return values:

```
<AcquisitionCount> Range: 0 to 4294967295
Increment: 1
*RST: 0
```

Usage: Query only
 Asynchronous command

Manual operation: See "[Available acqs](#)" on page 174

ACQUIRE:AVERAGE?

Returns the current number of acquired waveforms that contribute to the average.

Return values:

<CurrAverageCount> Range: 0 to 4294967295
 Increment: 1
 *RST: 0

Usage:

Query only
 Asynchronous command

Manual operation: See ["Current Average count"](#) on page 109

ACQUIRE:COUNT <MaxAcqCnt>

Sets the acquisition and average count, which has a double effect:

- It sets the number of waveforms acquired with `RUNSingle`.
- It defines the number of waveforms used to calculate the average waveform.

Parameters:

<MaxAcqCnt> Range: 1 to 16777215
 Increment: 1
 *RST: 1

Usage:

Asynchronous command

Manual operation: See ["N-single/Avg count"](#) on page 108

ACQUIRE:CURRENT?

Returns the current number of acquisitions that have been acquired.

Return values:

<CurrAcqCnt> Range: 0 to 18446744073709551615
 Increment: 1
 *RST: 0

Usage:

Query only
 Asynchronous command

ACQUIRE:INTERPOLATE <IntpolMd>

Selects the interpolation method.

Parameters:

<IntpolMd> LINear | SINX | SMHD

LINear

Linear interpolation between two adjacent sample points

SINX

Interpolation with a $\sin(x)/x$ function.

SMHD

Sample/Hold causes a histogram-like interpolation.

*RST: SINX

Usage: Asynchronous command

Manual operation: See "[Interpolation](#)" on page 109

ACQUIRE:POINTS:VALue] <RecordLength>

Sets the record length in manual record length mode. In automatic record length mode, it sets the maximum value of the record length for automatic calculation.

The record length is the number of waveform samples that are stored in one waveform record after processing, including interpolation.

Parameters:

<RecordLength> Range: 1000 to Device specific
 Increment: 2
 *RST: 1000
 Default unit: pts

Usage: Asynchronous command

Manual operation: See "[Record length](#), [Record length limit](#)" on page 108

ACQUIRE:POINTS:ARATE?

Returns the sample rate of the ADC, before waveform processing. The result is the interleaved sample rate or the non-interleaved one, depending on the channel usage.

Return values:

<ADCSampleRate> Range: 5 Gsample/s (interleaved), 2,5 Gsample/s (non-interleaved)
 Default unit: Hz

Usage: Query only
 Asynchronous command

ACQUIRE:POINTS:MAXimum <RecLengthLimit>

Sets the maximum record length, if [ACQUIRE:POINTS:MODE](#) is set to AUTO.

Parameters:

<RecLengthLimit> Range: 1000 to 800E+6
 Increment: 2
 *RST: 10E+6
 Default unit: pts

Usage: Asynchronous command

ACQUIRE:POINTS:MODE <RecLengthMode>

Selects the mode of the waveform record length adjustment.

Parameters:

<RecLengthMode> AUTO | MANual

AUTO

Record length is determined automatically and changes due to instrument internal adjustments.

MANual

The waveform record length is defined with `ACQUIRE:POINTS[:VALUE]`.

*RST: AUTO

Usage: Asynchronous command

Manual operation: See "[RL mode](#)" on page 108

ACQUIRE:RESolution <Resolution>

Defines the time between two waveform samples in the waveform record. It considers the processing of the captured samples including interpolation. A fine resolution with low values produces a more precise waveform record.

The resolution is the reciprocal value of `ACQUIRE:SRATE[:VALUE]`.

Parameters:

<Resolution> Range: 1E-15 to Device specific
 Increment: 1E-11
 *RST: Device specific
 Default unit: s

Usage: Asynchronous command

Manual operation: See "[Resolution](#)" on page 109

ACQUIRE:SRATE[:VALUE] <SampleRate>

Sets the number of waveform points per second in manual sample rate mode. In automatic sample rate mode, it sets the minimum value of the sample rate for automatic calculation.

The sample rate considers the samples of the ADC, and the processing of the captured samples including interpolation.

The value takes effect if `ACQUIRE:SRATE:MODE` is set to MANUAL.

Parameters:

<SampleRate> Range: Device specific to Device specific
 Increment: 1
 *RST: Device specific
 Default unit: Sa/s

Usage: Asynchronous command

Manual operation: See "[Sample rate, Min. sample rate](#)" on page 108

ACQUIRE:SRATE:MINIMUM <SampleRateMin>

Sets the minimum sample rate, if **ACQUIRE:SRATE:MODE** is set to **AUTO**.

Parameters:

<SampleRateMin> Increment: 1
 *RST: 2
 Default unit: Sa/s

Usage: Asynchronous command

ACQUIRE:SRATE:MODE <SampleRateMode>

Defines how the sample rate is set.

Parameters:

<SampleRateMode> **AUTO** | **MANual**

AUTO

Sample rate is determined automatically and changes due to instrument internal adjustments.

MANual

The sample rate is defined with **ACQUIRE:SRATE[:VALUE]**.

*RST: **AUTO**

Usage: Asynchronous command

Manual operation: See "[SR mode](#)" on page 107

ACQUIRE:SRREAL <HWSampleRate>

Returns the sample rate of the waveform after HW processing. Interpolation is not considered.

Parameters:

<HWSampleRate> Range: Device specific to ADC sample rate
 Increment: 0
 *RST: Device specific
 Default unit: Sa/s

Usage: Asynchronous command

ACQUIRE:TYPE <AcqMd>

Sets how the waveform is built from the captured samples.

Parameters:

<AcqMd> **SAMPlE** | **PDETECT** | **ENVELOPE** | **AVERAge**
 *RST: **SAMPlE**

Usage: Asynchronous command

Manual operation: See "[Acquisition mode](#)" on page 109

17.8.7 Fast segmentation

ACQUIRE:SEGMENTED:STATE <State>

If fast segmentation is enabled, the acquisitions are performed as fast as possible, without processing and displaying the waveforms. When acquisition has been stopped, the data is processed and the latest waveform is displayed. Older waveforms are stored in segments. You can display and analyze the segments using the history.

Parameters:

<State> ON | OFF
 *RST: OFF

Usage: Asynchronous command

Manual operation: See "[Fast segmentation](#)" on page 111

ACQUIRE:SEGMENTED:MAX <MaxAcqs>

If ON, the instrument acquires the maximum number of segments that can be stored in the memory. The maximum number depends on the current sample rate and record length settings.

If OFF, define the number of segments in a fast segmentation cycle with [ACQUIRE:COUNT](#).

Parameters:

<MaxAcqs> ON | OFF
 *RST: OFF

Usage: Asynchronous command

Manual operation: See "[Acquire maximum](#)" on page 110

17.8.8 Probes

- [Common probe settings](#).....476
- [Settings for active voltage probes](#).....481
- [Settings for current probes](#).....487
- [Probe attributes](#).....489

17.8.8.1 Common probe settings

The probe suffix <ch> selects the input channel to which the probe is connected.

| | |
|--|-----|
| PROBe<ch>:SETup:ATTenuation[:AUTO]? | 477 |
| PROBe<ch>:SETup:ATTenuation:MANual | 477 |
| PROBe<ch>:SETup:ATTenuation:DEFProbe | 477 |
| PROBe<ch>:SETup:ATTenuation:UNIT | 478 |
| PROBe<ch>:SETup:BANDwidth? | 478 |
| PROBe<ch>:SETup:OFFSet:TOMean | 479 |

| | |
|---|-----|
| PROBe<ch>:SETup:OFFSet:AZERo..... | 479 |
| PROBe<ch>:SETup:OFFSet:USEautozero..... | 479 |
| PROBe<ch>:SETup:NAME?..... | 480 |
| PROBe<ch>:SETup:STAtE?..... | 480 |
| PROBe<ch>:SETup:TYPE?..... | 480 |

PROBe<ch>:SETup:ATTenuation[:AUTO]?

Returns the attenuation of a detected or predefined probe.

Suffix:

<ch> 1 to 8, depending on instrument model. Index of the analog channel.

Return values:

<Attenuation> Range: 0.001 to 1000
 Increment: 0.1
 *RST: 1
 Default unit: V/V

Usage:

Query only
 Asynchronous command

Manual operation: See "[Manual attenuation](#)" on page 121

PROBe<ch>:SETup:ATTenuation:MANual <Attenuation>

Sets the attenuation for an unknown probe.

Suffix:

<ch> 1 to 8, depending on instrument model. Index of the analog channel.

Parameters:

<Attenuation> Range: 0.0001 to 10000
 Increment: 0.1
 *RST: 1
 Default unit: V/V

Usage:

Asynchronous command

Manual operation: See "[Manual attenuation](#)" on page 121

PROBe<ch>:SETup:ATTenuation:DEFProbe <PredefinedProbe>

Suffix:

<ch> 1 to 8, depending on instrument model. Index of the analog channel.

Parameters:

<PredefinedProbe> NONE | USER | ZC10 | ZC20 | ZC30 | ZD01A100 | ZD01A1000 | ZS10L | ZC02100 | ZC021000 | ZC03

USER

Probe is not detected and not known to the instrument. Set unit and attenuation manually.

ZC10 | ZC20 | ZC30 | ZS10L | ZC03

Type of the probe

ZD01A100 | ZD01A1000

High voltage differential probes, attenuation ratio according to the setting on the probe.

A100 = 100:1

A1000 = 1000:1

ZC02100 | ZC021000

Current probes 100 A or 1000 A according to the setting on the probe.

*RST: NONE

Usage: Asynchronous command

Manual operation: See "[Predefined probe, name and type of the probe](#)" on page 120

PROBe<ch>:SETup:ATTenuation:UNIT <Unit>

Returns the unit of the connected probe if the probe is detected or predefined. For unknown probes, you can select the required unit.

Suffix:

<ch> 1 to 8, depending on instrument model. Index of the analog channel.

Parameters:

<Unit> V | A | W
Voltage probe (V), current probe (A), power probe (W)
*RST: V

Usage: Asynchronous command

Manual operation: See "[Vertical unit](#)" on page 121

PROBe<ch>:SETup:BANDwidth?

Returns the bandwidth of the connected probe.

Suffix:

<ch> 1 to 8, depending on instrument model. Index of the analog channel.

Return values:

<Bandwidth> Range: 10000 to 20000000000
Increment: 10
*RST: 1500000000
Default unit: Hz

Usage: Query only
Asynchronous command

Manual operation: See "[Probe bandwidth](#)" on page 121

PROBe<ch>:SETup:OFFSet:TOMean

Compensates automatically for a DC component of the input signal using the result of a background mean measurement.

Suffix:
<ch> 1 to 8, depending on instrument model. Index of the analog channel.

Usage: Event
Asynchronous command

Manual operation: See "[Set offset to mean](#)" on page 121

PROBe<ch>:SETup:OFFSet:AZERo

Measures the zero error. Short the signal pin and the ground pin together and connect them to the ground of the DUT before sending the command.

Suffix:
<ch> 1 to 8, depending on instrument model. Index of the analog channel.

Usage: Event
Asynchronous command

Manual operation: See "[AutoZero, Use AutoZero](#)" on page 122

PROBe<ch>:SETup:OFFSet:USEautozero <UseAutoZeroOffset>

Includes the AutoZero offset in measurement results. The AutoZero error is detected with [PROBe<ch>:SETup:OFFSet:AZERo](#).

Suffix:
<ch> 1 to 8, depending on instrument model. Index of the analog channel.

Parameters:
<UseAutoZeroOffset> ON | OFF

*RST: OFF

Example:
PROB2:SET:OFFS:AZER
PROB2:SET:OFFS:USE ON
Detects the zero error and uses it for correction of measurement results.

Usage: Asynchronous command

Manual operation: See "[AutoZero, Use AutoZero](#)" on page 122

PROBe<ch>:SETup:NAME?

Queries the name of the probe.

Suffix:

<ch> 1 to 8, depending on instrument model. Index of the analog channel.

Return values:

<Name> Name string

Usage:

Query only
Asynchronous command

Manual operation: See ["Predefined probe, name and type of the probe"](#) on page 120

PROBe<ch>:SETup:STATe?

Queries if the probe at the specified input channel is active (detected) or not active (not detected). To switch the probe on, use [CHANnel<ch>:STATe](#).

Suffix:

<ch> 1 to 8, depending on instrument model. Index of the analog channel.

Return values:

<State> DETected | NDETECTED
*RST: NDETECTED

Usage:

Query only
Asynchronous command

Manual operation: See ["Predefined probe, name and type of the probe"](#) on page 120

PROBe<ch>:SETup:TYPE?

Queries the class of the probe.

Suffix:

<ch> 1 to 8, depending on instrument model. Index of the analog channel.

Return values:

<Type> String containing the probe class, e.g. None (no probe detected), passive, current, active diff., active single-ended.

Usage:

Query only
Asynchronous command

Manual operation: See ["Predefined probe, name and type of the probe"](#) on page 120

17.8.8.2 Settings for active voltage probes

The probe suffix <ch> selects the input channel to which the probe is connected.

| | |
|---|-----|
| PROBe<ch>:SETup:MODE..... | 481 |
| PROBe<ch>:SETup:ACCoupling..... | 482 |
| PROBe<ch>:SETup:CMOffset..... | 482 |
| PROBe<ch>:SETup:DISPlaydiff..... | 483 |
| PROBe<ch>:SETup:ZAXV..... | 483 |
| PROBe<ch>:PMETer:STATe..... | 483 |
| PROBe<ch>:PMETer:RESults:SINGle?..... | 484 |
| PROBe<ch>:PMETer:RESults:COMMon?..... | 484 |
| PROBe<ch>:PMETer:RESults:DIFFerential?..... | 484 |
| PROBe<ch>:PMETer:RESults:NEGative?..... | 485 |
| PROBe<ch>:PMETer:RESults:POSitive?..... | 485 |
| PROBe<ch>:SETup:ADVanced:AUDioverload..... | 486 |
| PROBe<ch>:SETup:ADVanced:FILTer..... | 486 |
| PROBe<ch>:SETup:ADVanced:RANGe..... | 486 |
| PROBe<ch>:SETup:ADVanced:PMTOffset..... | 487 |

PROBe<ch>:SETup:MODE <Mode>

The micro button is located on the probe head. Pressing this button, you initiate an action on the instrument directly from the probe. The button is disabled during internal automatic processes, for example, during self-alignment, autose, and level detection.

Select the action that you want to start from the probe.

Suffix:

<ch> 1 to 8, depending on instrument model. Index of the analog channel.

Parameters:

<Mode> RCONTinuous | RSINGle | AUToset | AZERo | OTMean | SITFile | NOACtion | FTRiglevel | PRSetup

RCONTinuous

Run continuous: the acquisition is running as long as the probe button is pressed.

RSINGle

Run single: starts a defined number of acquisitions (same as [Single] key).

AUToset

Starts the autose procedure.

AZERo

AutoZero: performs an automatic correction of the zero error.

OTMean

Set offset to mean: performs an automatic compensation for a DC component of the input signal.

SITFile

Save image to file: saves the display image in a file.

NOAction

Nothing is started on pressing the micro button.

FTRiglevel

Sets the trigger level automatically to $0.5 * (MaxPeak - MinPeak)$. The function is not available for an external trigger source.

PRSetup

Opens the "Probes Setup" dialog box.

*RST: RCONTinuous

Usage: Asynchronous command

Manual operation: See "[MicroButton](#)" on page 124

PROBe<ch>:SETup:ACCoupling <ProbeCouplingAC>

Enables AC coupling in R&S RT-ZPR power rail probes, which removes DC and very low-frequency components. The R&S RT-ZPR probe requires 50 Ω input termination, for which the channel AC coupling is not available. The probe setting allows AC coupling also at 50 Ω inputs.

Suffix:

<ch> 1 to 8, depending on instrument model. Index of the analog channel.

Parameters:

<ProbeCouplingAC> ON | OFF

*RST: OFF

Usage: Asynchronous command

Manual operation: See "[AC Coupling](#)" on page 127

PROBe<ch>:SETup:CMOffset <CMOffset>

Sets the common-mode offset to compensate for a common DC voltage that is applied to both input sockets (referenced to the ground socket). The setting is available for Rohde & Schwarz differential probes.

Suffix:

<ch> 1 to 8, depending on instrument model. Index of the analog channel.

Parameters:

<CMOffset> Range: -1E+26 to 1E+26

Increment: 0.001

*RST: 0

Default unit: V

Usage: Asynchronous command

Manual operation: See "[CM offset](#)" on page 126

PROBe<ch>:SETup:DISPlaydiff <DisplayDiff>

Selects the voltage to be measured by the R&S ProbeMeter of differential active probes:

Suffix:

<ch> 1 to 8, depending on instrument model. Index of the analog channel.

Parameters:

<DisplayDiff> DIFFerential | SINGleended

DIFFerential

Measures differential and common mode voltages

SINGleended

Measures the voltage between the positive/negative signal socket and the ground.

*RST: DIFFerential

Usage: Asynchronous command

Manual operation: See "[Display](#)" on page 126

PROBe<ch>:SETup:ZAXV <AttenuationZA15>

If you use the external attenuator R&S RT-ZA15 together with one of the differential active probes R&S RT-ZD10/20/30, enable "RT-ZA15 attenuator" to include the external attenuation in the measurements.

Suffix:

<ch> 1 to 8, depending on instrument model. Index of the analog channel.

Parameters:

<AttenuationZA15> ON | OFF

*RST: OFF

Usage: Asynchronous command

Manual operation: See "[RT-ZA15 attenuator](#)" on page 126

PROBe<ch>:PMETer:STATe <State>

Activates the integrated R&S ProbeMeter on probes with Rohde & Schwarz probe interface.

Suffix:

<ch> 1 to 8, depending on instrument model. Index of the analog channel.

Parameters:

<State> ON | OFF

*RST: OFF

Usage: Asynchronous command
Manual operation: See "[ProbeMeter](#)" on page 124

PROBe<ch>:PMETer:RESults:SINGle?

Returns the R&S ProbeMeter measurement result of single-ended active Rohde & Schwarz probes, the voltage measured between the probe tip and the ground.

Suffix:
 <ch> 1 to 8, depending on instrument model. Index of the analog channel.

Return values:
 <Result> Range: -1E+26 to 1E+26
 Increment: 0.001
 *RST: 0
 Default unit: V

Usage: Query only
 Asynchronous command

Manual operation: See "[ProbeMeter](#)" on page 124

PROBe<ch>:PMETer:RESults:COMMon?

Returns the R&S ProbeMeter measurement result of differential active R&S probes: the common mode voltage, which is the mean voltage between the signal sockets and the ground socket.

Suffix:
 <ch> 1 to 8, depending on instrument model. Index of the analog channel.

Return values:
 <Result> Range: -1E+26 to 1E+26
 Increment: 0.001
 *RST: 0
 Default unit: V

Usage: Query only
 Asynchronous command

Manual operation: See "[ProbeMeter](#)" on page 124

PROBe<ch>:PMETer:RESults:DIFFerential?

Returns the R&S ProbeMeter measurement result of differential active Rohde & Schwarz probes, the differential voltage - the voltage between the positive and negative signal sockets.

Suffix:
 <ch> 1 to 8, depending on instrument model. Index of the analog channel.

Return values:
 <Result> Range: -1E+26 to 1E+26
 Increment: 0.001
 *RST: 0
 Default unit: V

Usage: Query only
 Asynchronous command

Manual operation: See "[ProbeMeter](#)" on page 124

PROBe<ch>:PMETer:RESults:NEGative?

Returns the R&S ProbeMeter measurement result of differential active R&S probes, the voltage that is measured between the negative signal socket and the ground.

Suffix:
 <ch> 1 to 8, depending on instrument model. Index of the analog channel.

Return values:
 <Result> Range: -1E+26 to 1E+26
 Increment: 0.001
 *RST: 0
 Default unit: V

Usage: Query only
 Asynchronous command

Manual operation: See "[ProbeMeter](#)" on page 124

PROBe<ch>:PMETer:RESults:POSitive?

Returns the R&S ProbeMeter measurement result of differential active R&S probes: the voltage that is measured between the positive signal socket and the ground.

Suffix:
 <ch> 1 to 8, depending on instrument model. Index of the analog channel.

Return values:
 <Result> Range: -1E+26 to 1E+26
 Increment: 0.001
 *RST: 0
 Default unit: V

Usage: Query only
 Asynchronous command

Manual operation: See "[ProbeMeter](#)" on page 124

PROBe<ch>:SETup:ADVanced:AUDioverload <Sound>

Activates the acoustic overrange warning in the probe control box. The command is relevant for R&S RT-ZHD probes.

Suffix:

<ch> 1 to 8, depending on instrument model. Index of the analog channel.

Parameters:

<Sound> ON | OFF
*RST: OFF

Usage: Asynchronous command

Manual operation: See "[Audible overrange](#)" on page 129

PROBe<ch>:SETup:ADVanced:FILTer <State>

Activates the lowpass filter in the probe control box. The filter frequency depends on the probe type and is indicated on the probe control box.

Suffix:

<ch> 1 to 8, depending on instrument model. Index of the analog channel.

Parameters:

<State> ON | OFF
*RST: OFF

Usage: Asynchronous command

Manual operation: See "[Bandwidth limit](#)" on page 129

PROBe<ch>:SETup:ADVanced:RANGe <ProbeRange>

Sets the voltage range of an R&S RT-ZHD probe.

Suffix:

<ch> 1 to 8, depending on instrument model. Index of the analog channel.

Parameters:

<ProbeRange> AUTO | MHIGH | MLOW

AUTO

The voltage range is set with [CHANnel<ch>:SCALE](#).

MHIGH

Sets the higher voltage range of the connected probe. To query the value, use [PROBe<ch>:SETup:ATTenuation\[:AUTO\]?](#).

MLOW

Sets the lower voltage range of the connected probe. To query the value, use [PROBe<ch>:SETup:ATTenuation\[:AUTO\]?](#).

*RST: AUTO

Usage: Asynchronous command

Manual operation: See "[Range](#)" on page 129

PROBe<ch>:SETup:ADVanced:PMTOffset

Sets the measured ProbeMeter value as offset. Thus, the value is considered in measurements.

Suffix:

<ch> 1 to 8, depending on instrument model. Index of the analog channel.

Usage:

Setting only
Asynchronous command

Manual operation: See "[ProbeMeter to offset](#)" on page 128

17.8.8.3 Settings for current probes

The probe suffix <ch> selects the input channel to which the probe is connected.

PROBe<ch>:SETup:GAIN:AUTO?

Returns the gain of a detected or predefined current probe.

Suffix:

<ch> 1 to 8, depending on instrument model. Index of the analog channel.

Return values:

<Gain> Range: 0.001 to 1000
Increment: 0.1
*RST: 1
Default unit: A/V

Usage:

Query only
Asynchronous command

Manual operation: See "[Gain, Manual gain](#)" on page 130

PROBe<ch>:SETup:GAIN:MANual <Gain>

Sets the gain for an unknown current probe.

Suffix:

<ch> 1 to 8, depending on instrument model. Index of the analog channel.

Parameters:

<Gain> Range: 0.0001 to 10000
 Increment: 0.0001
 *RST: 1
 Default unit: V/V

Usage: Asynchronous command

Manual operation: See "[Gain, Manual gain](#)" on page 130

PROBe<ch>:SETup:DEGauss

Demagnetizes the core if it has been magnetized by switching the power on and off, or by an excessive input. Always carry out demagnetizing before measurement.

Suffix:

<ch> 1 to 8, depending on instrument model. Index of the analog channel.

Usage: Event
 Asynchronous command

Manual operation: See "[DeGauss](#)" on page 131

PROBe<ch>:SETup:OFFSet:ZADJust <ZeroAdjustValue>

Set the waveform to zero position. It corrects the effect of a voltage offset or temperature drift. To set the value by the instrument, use [PROBe<ch>:SETup:OFFSet:AZERo](#).

Suffix:

<ch> 1 to 8, depending on instrument model. Index of the analog channel.

Parameters:

<ZroAdjVal> Range: -100 to 100
 Increment: 0.1
 *RST: 0
 Default unit: %

Usage: Asynchronous command

Manual operation: See "[Zero adjust](#)" on page 131

PROBe<ch>:SETup:OFFSet:STPRobe

Saves the zero adjust value in the probe box. If you connect the probe to another channel or to another Rohde & Schwarz oscilloscope, the value is read out again, and you can use the probe without further adjustment.

Suffix:

<ch> 1 to 8, depending on instrument model. Index of the analog channel.

Usage: Event
Asynchronous command

Manual operation: See "Save to probe" on page 131

17.8.8.4 Probe attributes

| | |
|-----------------------------------|-----|
| PROBe<ch>:ID:PARTnumber?..... | 489 |
| PROBe<ch>:ID:PRDate?..... | 489 |
| PROBe<ch>:ID:SRNumber?..... | 489 |
| PROBe<ch>:ID:SWVersion?..... | 490 |
| PROBe<ch>:SETup:CAPacitance?..... | 490 |
| PROBe<ch>:SETup:IMPedance?..... | 490 |

PROBe<ch>:ID:PARTnumber?

Queries the Rohde & Schwarz part number of the probe.

Suffix:

<ch> 1 to 8, depending on instrument model. Index of the analog channel.

Return values:

<PartNumber> Part number in a string.

Usage:

Query only
Asynchronous command

PROBe<ch>:ID:PRDate?

Queries the production date of the probe.

Suffix:

<ch> 1 to 8, depending on instrument model. Index of the analog channel.

Return values:

<ProductionDate> Date in a string.

Usage:

Query only
Asynchronous command

PROBe<ch>:ID:SRNumber?

Queries the serial number of the probe.

Suffix:

<ch> 1 to 8, depending on instrument model. Index of the analog channel.

Return values:

<SerialNo> Serial number in a string.

Usage: Query only
Asynchronous command

PROBe<ch>:ID:SWVersion?

Queries the version of the probe firmware.

Suffix:
<ch> 1 to 8, depending on instrument model. Index of the analog channel.

Return values:
<Softwareversion> Version number in a string.

Usage: Query only
Asynchronous command

PROBe<ch>:SETup:CAPacitance?

Queries the input capacitance of the probe.

Suffix:
<ch> 1 to 8, depending on instrument model. Index of the analog channel.

Return values:
<InputCapacity> Range: 1E-13 to 1E-07
Default unit: F

Usage: Query only
Asynchronous command

PROBe<ch>:SETup:IMPedance?

Queries the termination of the probe.

Suffix:
<ch> 1 to 8, depending on instrument model. Index of the analog channel.

Return values:
<InputImpedance> Range: 0 to 1E+9
Default unit: Ω

Usage: Query only
Asynchronous command

17.8.9 High definition mode

| | |
|------------------------------|-----|
| HDEFinition:BWIDth..... | 491 |
| HDEFinition:RESolution?..... | 491 |
| HDEFinition:STATe..... | 491 |

HDEFinition:BWIDth <Bandwidth>

Sets the filter bandwidth for the high definition mode.

Parameters:

| | | |
|-------------|---------------|---------------|
| <Bandwidth> | Range: | 10000 to 2E+9 |
| | Increment: | 1000 |
| | *RST: | 100E+6 |
| | Default unit: | Hz |

Usage: Asynchronous command

Manual operation: See "[Bandwidth](#)" on page 112

HDEFinition:RESolution?

Displays the resulting vertical resolution in high definition mode. The higher the filter bandwidth, the lower the resolution.

Return values:

| | | |
|--------------|---------------|---------|
| <Resolution> | Range: | 0 to 18 |
| | Increment: | 0.1 |
| | *RST: | 0 |
| | Default unit: | bit |

Usage: Query only
Asynchronous command

Manual operation: See "[Resolution in bits](#)" on page 112

HDEFinition:STATe <State>

Enables high definition mode, which increases the numeric resolution of the waveform signal.

Parameters:

| | |
|---------|-------------------------------|
| <State> | ON OFF |
| | ON: high definition mode |
| | OFF: normal oscilloscope mode |
| | *RST: OFF |

Usage: Asynchronous command

Manual operation: See "[State](#)" on page 112

17.8.10 Reference clock

SENSe[:ROSCillator]:OUTPut[:ENABLE] <ReferenceOutput>

Sends the internal reference clock signal to the Ref Out 10MHz connector.

Parameters:

<ReferenceOutput> ON | OFF
 *RST: OFF

Usage:

SCPI confirmed
 Asynchronous command

Manual operation: See "[Output 10 MHz ref. signal](#)" on page 104

SENSe[:ROSCillator]:SOURce <RefSource>

Enables the use of an external 10 MHz reference signal instead of the internal reference clock.

Parameters:

<RefSource> INTernal | EXTernal
 *RST: INTernal

Usage:

Asynchronous command

Manual operation: See "[Use external ref. clock](#)" on page 104

17.9 Trigger

Trigger commands use several suffixes.

LEVel<n>, Noise<m>

The suffix indicates the analog channel, for which the command takes effect. C1 has suffix 1, C2 has suffix 2, and so on.

Event<ev>

The event suffix is always 1 and can be omitted.

Asynchronous commands

Some of the commands in the following chapter are asynchronous. An overlapping or asynchronous command does not automatically finish executing before the next command starts executing. If overlapping commands must be executed in a defined order, e.g. to avoid wrong measurement results, they must be serviced sequentially.

To prevent an overlapping execution of commands, one of the commands *OPC, *OPC? or *WAI can be used after the command or a command set.

For more information, see:

- www.rohde-schwarz.com/rc-via-sdpi, chapter "Command sequence and synchronization"

17.9.1 Common trigger settings

| | |
|---|-----|
| TRIGger:MEVents:MODE..... | 493 |
| TRIGger:EVENT<ev>:TYPE..... | 493 |
| TRIGger:EVENT<ev>:LEVel<n>[:VALue]..... | 493 |
| TRIGger:FINDlevel..... | 494 |
| TRIGger:EVENT<ev>:SOURce..... | 494 |

TRIGger:MEVents:MODE <Class>

Trigger on single event is the only supported mode.

Parameters:

<Class> SINGle
 *RST: SINGle

Usage: Asynchronous command

Manual operation: See "[Trigger on](#)" on page 136

TRIGger:EVENT<ev>:TYPE <Type>

Selects the trigger type.

Suffix:

<ev> 1, can be omitted

Parameters:

<Type> EDGE | GLITCh | WIDTH | RUNT | WINDow | TIMEout | INTerval |
 SLEWrate | ANEDge

ANEDge = analog edge trigger is the only trigger type if the
 extern trigger source is used.

*RST: EDGE

Usage: Asynchronous command

Manual operation: See "[Type](#)" on page 136

TRIGger:EVENT<ev>:LEVel<n>[:VALue] <Level>

Sets the trigger level for the specified event and source (channel).

If the trigger source is serial bus, the trigger level is set by the thresholds in the proto-
 col configuration.

Suffix:

<ev> 1, can be omitted

<n> 1 to 8, depending on instrument model. Index of the analog
 channel.

Parameters:

<Level> Range: -10 to 10
 Increment: 0.001
 *RST: 0
 Default unit: V

Usage: Asynchronous command

Manual operation: See "[Level](#)" on page 137

TRIGger:FINDlevel

Sets the trigger level automatically to $0.5 * (MaxPeak - MinPeak)$.

Usage: Event
 Asynchronous command

Manual operation: See "[Find level](#)" on page 137

TRIGger:EVENT<ev>:SOURCE <SourceDetailed>

Selects the source of the trigger signal for the selected trigger event. The trigger source works even if it is not displayed in a diagram.

All inputs can be used as trigger source.

Suffix:

<ev> 1, can be omitted

Parameters:

<SourceDetailed> C1 | C2 | C3 | C4 | C5 | C6 | C7 | C8 | EXTernanalog | LINE | D0
 | D1 | D2 | D3 | D4 | D5 | D6 | D7 | D8 | D9 | D10 | D11 | D12 |
 D13 | D14 | D15 | SBUS1 | SBUS2 | SBUS3 | SBUS4
 *RST: C1

Usage: Asynchronous command

Manual operation: See "[Source](#)" on page 136

17.9.2 Edge trigger

| | |
|-------------------------------------|-----|
| TRIGger:EVENT<ev>:EDGE:SLOPe..... | 494 |
| TRIGger:ANEDge:LEVel..... | 495 |
| TRIGger:ANEDge:COUPling..... | 495 |
| TRIGger:ANEDge:FILTer..... | 495 |
| TRIGger:ANEDge:CUToff:HIGHPass..... | 496 |
| TRIGger:ANEDge:CUToff:LOWPass..... | 496 |
| TRIGger:ANEDge:NREJect..... | 496 |

TRIGger:EVENT<ev>:EDGE:SLOPe <Slope>

Sets the edge direction for the trigger.

Suffix:
 <ev> 1, can be omitted

Parameters:
 <Slope> POSitive | NEGative | EITHer
 *RST: POSitive

Usage: Asynchronous command

Manual operation: See "[Slope](#)" on page 138

TRIGger:ANEDge:LEVel <ExtTrigLev>

Sets the trigger level for the external trigger source.

Parameters:
 <ExtTrigLev> Range: - 5 to 5
 Default unit: V

Usage: Asynchronous command

Manual operation: See "[Level](#)" on page 137

TRIGger:ANEDge:COUPling <Coupling>

Sets the connection of the external trigger signal, i.e. the input impedance and a termination. The coupling determines what part of the signal is used for triggering.

Parameters:
 <Coupling> DC | DCLimit | AC

DC
 Connection with 50 Ω termination, passes both DC and AC components of the signal.

DCLimit
 Connection with 1 M Ω termination, passes both DC and AC components of the signal.

AC
 Connection with 1 M Ω termination through DC capacitor, removes DC and very low-frequency components. The waveform is centered on zero volts.

*RST: DCLimit

Usage: Asynchronous command

Manual operation: See "[Coupling](#)" on page 139

TRIGger:ANEDge:FILTer <Filter>

Selects the filter mode for the external trigger signal.

Parameters:

<Filter> OFF | LFReject | RFReject
 *RST: OFF

Usage: Asynchronous command

Manual operation: See "[Filter, Cut-off](#)" on page 140

TRIGger:ANEDge:CUToff:HIGHpass <CutOffFreq>

Frequencies below the cutoff frequency are rejected, higher frequencies pass the filter.

Parameters:

<CutOffFreq> KHZ5 | KHZ50
 KHZ5 = 5 kHz
 KHZ50 = 50 kHz
 *RST: KHZ50

Usage: Asynchronous command

Manual operation: See "[Filter, Cut-off](#)" on page 140

TRIGger:ANEDge:CUToff:LOWPass <CutOffFreq>

Frequencies higher than the cutoff frequency are rejected, lower frequencies pass the filter.

Parameters:

<CutOffFreq> KHZ50 | MHZ50
 KHZ50 = 50 kHz
 MHZ50 = 50 MHz
 *RST: KHZ50

Usage: Asynchronous command

Manual operation: See "[Filter, Cut-off](#)" on page 140

TRIGger:ANEDge:NREJect <NoiseReject>

Enables an automatic hysteresis on the trigger level to avoid unwanted trigger events caused by noise.

Parameters:

<NoiseReject> ON | OFF
 *RST: OFF

Usage: Asynchronous command

Manual operation: See "[Trigger noise reject](#)" on page 140

17.9.3 Glitch trigger

| | |
|--|-----|
| TRIGger:EVENT<ev>:GLITch:POLarity..... | 497 |
| TRIGger:EVENT<ev>:GLITch:RANGe..... | 497 |
| TRIGger:EVENT<ev>:GLITch:WIDTh..... | 497 |

TRIGger:EVENT<ev>:GLITch:POLarity <Polarity>

Sets the polarity of a pulse, which is the direction of the first pulse slope.

Suffix:

<ev> 1, can be omitted

Parameters:

<Polarity> POSitive | NEGative | EITHer
*RST: POSitive

Usage: Asynchronous command

Manual operation: See "[Polarity](#)" on page 141

TRIGger:EVENT<ev>:GLITch:RANGe <RangeMode>

Selects which glitches are identified: shorter or longer than the width specified using [TRIGger:EVENT<ev>:GLITch:WIDTh](#).

Suffix:

<ev> 1, can be omitted

Parameters:

<RangeMode> SHORter | LONGer

SHORter

Glitches shorter than the specified width are identified.

LONGer

Glitches longer than the specified width are identified.

*RST: SHORter

Usage: Asynchronous command

Manual operation: See "[Range](#)" on page 141

TRIGger:EVENT<ev>:GLITch:WIDTh <Width>

Sets the length of a glitch. The instrument triggers on pulses shorter or longer than this value, depending on the value set with [TRIGger:EVENT<ev>:GLITch:RANGe](#).

Suffix:

<ev> 1, can be omitted

Parameters:

<Width> Range: 1E-10 to 10000
 Increment: 0.0001
 *RST: 1E-09
 Default unit: s

Usage: Asynchronous command

Manual operation: See "[Width](#)" on page 141

17.9.4 Width trigger

| | |
|--|-----|
| TRIGger:EVENT<ev>:WIDTH:DELTA | 498 |
| TRIGger:EVENT<ev>:WIDTH:POLarity | 498 |
| TRIGger:EVENT<ev>:WIDTH:RANGe | 498 |
| TRIGger:EVENT<ev>:WIDTH:WIDTH | 499 |

TRIGger:EVENT<ev>:WIDTH:DELTA <WidthDelta>

Defines a range around the width value.

Suffix:

<ev> 1, can be omitted

Parameters:

<WidthDelta> Range: 0 to 432
 Increment: 5E-10
 *RST: 0
 Default unit: s

Usage: Asynchronous command

Manual operation: See "[±Delta](#)" on page 143

TRIGger:EVENT<ev>:WIDTH:POLarity <Polarity>

Sets the polarity of a pulse, which is the direction of the first pulse slope.

Suffix:

<ev> 1, can be omitted

Parameters:

<Polarity> POSitive | NEGative | EITHer
 *RST: POSitive

Usage: Asynchronous command

Manual operation: See "[Polarity](#)" on page 142

TRIGger:EVENT<ev>:WIDTH:RANGe <RangeMode>

Selects how the range of a pulse width is defined.

| | |
|--------------------------|---|
| Suffix: | |
| <ev> | 1, can be omitted |
| Parameters: | |
| <RangeMode> | WITHin OUTSide SHORter LONGer |
| | *RST: WITHin |
| Usage: | Asynchronous command |
| Manual operation: | See " Range " on page 143 |

TRIGger:EVENT<ev>:WIDTh:WIDTh <Width>

Depending on the values of [TRIGger:EVENT<ev>:WIDTh:RANGe](#) the width sets:

- For the ranges `Within` and `Outside`, the width defines the center of a time range which is defined by the limits " $\pm\Delta$ " (see [TRIGger:EVENT<ev>:WIDTh:DELTA](#)).
- For the ranges `Shorter` and `Longer`, it defines the maximum and minimum time lapse, respectively.

| | |
|--------------------------|---|
| Suffix: | |
| <ev> | 1, can be omitted |
| Parameters: | |
| <Width> | Range: 1E-10 to 10000 |
| | Increment: 1E-07 |
| | *RST: 5E-09 |
| | Default unit: s |
| Usage: | Asynchronous command |
| Manual operation: | See " Width " on page 143 |

17.9.5 Runt trigger

| | |
|---|-----|
| TRIGger:EVENT<ev>:LEVel<n>:RUNT:LOWer | 499 |
| TRIGger:EVENT<ev>:LEVel<n>:RUNT:UPPer | 500 |
| TRIGger:EVENT<ev>:RUNT:DELTA | 500 |
| TRIGger:EVENT<ev>:RUNT:POLarity | 500 |
| TRIGger:EVENT<ev>:RUNT:RANGe | 501 |
| TRIGger:EVENT<ev>:RUNT:WIDTh | 501 |

TRIGger:EVENT<ev>:LEVel<n>:RUNT:LOWer <Level>

Sets the lower voltage limit.

| | |
|----------------|---|
| Suffix: | |
| <ev> | 1, can be omitted |
| <n> | 1 to 8, depending on instrument model. Index of the analog channel. |

Parameters:

<Level> Range: -10 to 10
 Increment: 0.001
 *RST: -0.1
 Default unit: V

Usage: Asynchronous command

Manual operation: See "[Lower level](#)" on page 144

TRIGger:EVENT<ev>:LEVel<n>:RUNT:UPPer <Level>

Sets the upper voltage limit.

Suffix:

<ev> 1, can be omitted

<n> 1 to 8, depending on instrument model. Index of the analog channel.

Parameters:

<Level> Range: -10 to 10
 Increment: 0.001
 *RST: 0.1
 Default unit: V

Usage: Asynchronous command

Manual operation: See "[Upper level](#)" on page 144

TRIGger:EVENT<ev>:RUNT:DELTA <WidthDelta>

Defines a range around the runt width specified using [TRIGger:EVENT<ev>:RUNT:WIDTH](#).

Available if [TRIGger:EVENT<ev>:RUNT:RANGE](#) is set to WITHin or OUTSide.

Suffix:

<ev> 1, can be omitted

Parameters:

<WidthDelta> Range: 1E-10 to 864
 Increment: 1E-07
 *RST: 1E-10
 Default unit: s

Usage: Asynchronous command

Manual operation: See "[±Delta](#)" on page 145

TRIGger:EVENT<ev>:RUNT:POLarity <Polarity>

Sets the polarity of a pulse, which is the direction of the first pulse slope.

| | |
|--------------------------|--|
| Suffix: | |
| <ev> | 1, can be omitted |
| Parameters: | |
| <Polarity> | POSitive NEGative EITHer |
| | *RST: POSitive |
| Usage: | Asynchronous command |
| Manual operation: | See " Polarity " on page 141 |

TRIGger:EVENT<ev>:RUNT:RANGe <Mode>

Defines the time limit of the runt pulse in relation to the [TRIGger:EVENT<ev>:RUNT:WIDTh](#) and [TRIGger:EVENT<ev>:RUNT:DELTA](#) settings.

| | |
|--------------------------|---|
| Suffix: | |
| <ev> | 1, can be omitted |
| Parameters: | |
| <Mode> | ANY LONGer SHORter WITHin OUTSide |
| | ANY |
| | Triggers on all runts fulfilling the level condition, without time limitation. |
| | LONGer |
| | Triggers on runts longer than the given runt width. |
| | SHORter |
| | Triggers on runts shorter than the given runt width. |
| | WITHin |
| | Triggers if the runt length is inside a given time range. The range is defined by runt width and $\pm\Delta$. |
| | OUTSide |
| | Triggers if the runt length is outside a given time range. The range is defined by runt width and $\pm\Delta$. |
| | *RST: ANY |
| Usage: | Asynchronous command |
| Manual operation: | See " Range " on page 145 |

TRIGger:EVENT<ev>:RUNT:WIDTh <Width>

Defines the upper or lower voltage threshold.

It is not available if [TRIGger:EVENT<ev>:RUNT:RANGe](#) is set to ANY.

| | |
|----------------|-------------------|
| Suffix: | |
| <ev> | 1, can be omitted |

Parameters:

<Width> Range: 1E-10 to 10000
 Increment: 1E-07
 *RST: 5E-09
 Default unit: s

Usage: Asynchronous command

Manual operation: See "[Runt width](#)" on page 145

17.9.6 Window trigger

| | |
|---|-----|
| TRIGger:EVENT<ev>:LEVel<n>:WINDow:LOWer | 502 |
| TRIGger:EVENT<ev>:LEVel<n>:WINDow:UPPer | 502 |
| TRIGger:EVENT<ev>:WINDow:DELTA | 503 |
| TRIGger:EVENT<ev>:WINDow:RANGe | 503 |
| TRIGger:EVENT<ev>:WINDow:TIME | 504 |
| TRIGger:EVENT<ev>:WINDow:WIDTh | 504 |

TRIGger:EVENT<ev>:LEVel<n>:WINDow:LOWer <Level>

Sets the lower voltage limit.

Suffix:

<ev> 1, can be omitted
 <n> 1 to 8, depending on instrument model. Index of the analog channel.

Parameters:

<Level> Range: -10 to 10
 Increment: 0.001
 *RST: -0.1
 Default unit: V

Usage: Asynchronous command

Manual operation: See "[Lower level](#)" on page 147

TRIGger:EVENT<ev>:LEVel<n>:WINDow:UPPer <Level>

Sets the upper voltage limit.

Suffix:

<ev> 1, can be omitted
 <n> 1 to 8, depending on instrument model. Index of the analog channel.

Parameters:

<Level> Range: 0 to 1000
 Increment: 1E-06
 *RST: 0.1
 Default unit: V

Usage: Asynchronous command

Manual operation: See "[Upper level](#)" on page 146

TRIGger:EVENT<ev>:WINDow:DELTA <WidthDelta>

Defines a range around the width value.

Suffix:

<ev> 1, can be omitted

Parameters:

<WidthDelta> Range: 0 to 432
 Increment: 5E-10
 *RST: 0
 Default unit: s

Usage: Asynchronous command

Manual operation: See "[±Delta](#)" on page 147

TRIGger:EVENT<ev>:WINDow:RANGe <RangeMode>

Selects how the signal run is compared with the window.

Suffix:

<ev> 1, can be omitted

Parameters:

<RangeMode> ENTer | EXIT | WITHin | OUTSide

ENTer

Triggers when the signal crosses the upper or lower level and thus enters the window made up of these two levels.

EXIT

Triggers when the signal leaves the window.

WITHin

Triggers if the signal stays between the upper and lower level for a specified time. The time is defined with [TRIGger:EVENT<ev>:WINDow:TIME](#).

[TRIGger:EVENT<ev>:WINDow:TIME](#).

OUTSide

Triggers if the signal stays above the upper level or below the lower level for a specified time. The time is defined with

[TRIGger:EVENT<ev>:WINDow:TIME](#).

*RST: ENTer

Usage: Asynchronous command

Manual operation: See "[Vertical condition](#)" on page 146

TRIGger:EVENT<ev>:WINDow:TIME <TimeRangeMode>

Available for `TRIGger:EVENT<ev>:WIDTh:RANGe` = `WITHin` and `OUTSide`.

Selects how the time limit of the window is defined.

You can specify the width with `TRIGger:EVENT<ev>:WIDTh:WIDTh` and the delta with `TRIGger:EVENT<ev>:WINDow:DELTA`.

Suffix:

<ev> 1, can be omitted

Parameters:

<TimeRangeMode> `WITHin` | `OUTSide` | `SHORter` | `LONGer`

WITHin

Triggers if the signal stays inside or outside the vertical window limits at least for the time *Width - Delta* and for *Width + Delta* at the most.

OUTSide

"Outside" is the opposite definition of "Within". The instrument triggers if the signal stays inside or outside the vertical window limits for a time shorter than *Width - Delta* or longer than *Width + Delta*.

SHORter

Triggers if the signal crosses vertical limits before the specified width time is reached.

LONGer

Triggers if the signal crosses vertical limits before the specified width time is reached.

*RST: `WITHin`

Usage: Asynchronous command

Manual operation: See "[Time condition](#)" on page 147

TRIGger:EVENT<ev>:WINDow:WIDTh <Width>

Depending on the values of `TRIGger:EVENT<ev>:WINDow:RANGe` the width sets:

- For the ranges `Within` and `Outside`, the width defines the center of a time range. The range is defined by the limits " $\pm\Delta$ ", see `TRIGger:EVENT<ev>:WINDow:DELTA`.
- For the ranges `Shorter` and `Longer`, it defines the maximum and minimum time lapse, respectively.

Suffix:

<ev> 1, can be omitted

Parameters:

<Width> Range: 1E-10 to 10000
 Increment: 1E-07
 *RST: 5E-09
 Default unit: s

Usage: Asynchronous command

Manual operation: See "[Width](#)" on page 147

17.9.7 Timeout trigger

[TRIGger:EVENT<ev>:TIMEout:RANGe](#)..... 505

[TRIGger:EVENT<ev>:TIMEout:TIME](#).....505

TRIGger:EVENT<ev>:TIMEout:RANGe <TimeoutMode>

Sets the relation of the signal level to the trigger level for the timeout trigger.

Suffix:

<ev> 1, can be omitted

Parameters:

<TimeoutMode> HIGH | LOW | EITHer
 HIGH = stays high, the signal level stays above the trigger level.
 LOW = stays low, the signal level stays below the trigger level.
 EITHer = stays high or low.
 *RST: HIGH

Usage: Asynchronous command

Manual operation: See "[Range](#)" on page 148

TRIGger:EVENT<ev>:TIMEout:TIME <Time>

Sets the time limit for the timeout at which the instrument triggers.

Suffix:

<ev> 1, can be omitted

Parameters:

<Time> Range: 1E-10 to 10000
 Increment: 1E-07
 *RST: 1E-07
 Default unit: s

Usage: Asynchronous command

Manual operation: See "[Time](#)" on page 148

17.9.8 Interval trigger

| | |
|---------------------------------------|-----|
| TRIGger:EVENT<ev>:INTerval:DELTA..... | 506 |
| TRIGger:EVENT<ev>:INTerval:RANGE..... | 506 |
| TRIGger:EVENT<ev>:INTerval:SLOPe..... | 507 |
| TRIGger:EVENT<ev>:INTerval:WIDTh..... | 507 |

TRIGger:EVENT<ev>:INTerval:DELTA <WidthDelta>

Sets a range around the interval width value specified with `TRIGger:EVENT<ev>:INTerval:WIDTh`.

Suffix:

<ev> 1, can be omitted

Parameters:

<WidthDelta> Range: 0 to 10
 Increment: 1E-07
 *RST: 0
 Default unit: s

Usage: Asynchronous command

Manual operation: See "[±Delta](#)" on page 150

TRIGger:EVENT<ev>:INTerval:RANGE <RangeMode>

Defines the range of an interval in relation to the interval width specified using `TRIGger:EVENT<ev>:INTerval:WIDTh` and `TRIGger:EVENT<ev>:INTerval:DELTA`.

Suffix:

<ev> 1, can be omitted

Parameters:

<RangeMode> WITHin | OUTSide | SHORter | LONGer

WITHin

Triggers on pulses inside a given range. The range is defined by the interval width $\pm\delta$.

OUTSide

Triggers on pulses outside a given range. The range is defined by the interval width $\pm\delta$.

SHORter

Triggers on pulses shorter than the given interval width.

LONGer

Triggers on pulses longer than the given interval width.

*RST: OUTSide

Usage: Asynchronous command

Manual operation: See "[Range](#)" on page 149

TRIGger:EVENT<ev>:INTERval:SLOPe <Slope>

Sets the edge for the trigger. You can analyze the interval between positive edges or between negative edges.

Suffix:

<ev> 1, can be omitted

Parameters:

<Slope> POSitive | NEGative | EITHer
*RST: POSitive

Usage: Asynchronous command

Manual operation: See "[Slope](#)" on page 149

TRIGger:EVENT<ev>:INTERval:WIDTh <Width>

Sets the time between two pulses for the interval trigger.

Suffix:

<ev> 1, can be omitted

Parameters:

<Width> Range: 1E-10 to 10000
Increment: 1E-07
*RST: 5E-09
Default unit: s

Usage: Asynchronous command

Manual operation: See "[Interv. width](#)" on page 150

17.9.9 Slew rate trigger

| | |
|---|-----|
| TRIGger:EVENT<ev>:LEVel<n>:SLEW:LOWer | 507 |
| TRIGger:EVENT<ev>:LEVel<n>:SLEW:UPPer | 508 |
| TRIGger:EVENT<ev>:SLEW:DELTA | 508 |
| TRIGger:EVENT<ev>:SLEW:RANGe | 508 |
| TRIGger:EVENT<ev>:SLEW:RATE | 509 |
| TRIGger:EVENT<ev>:SLEW:SLOPe | 509 |

TRIGger:EVENT<ev>:LEVel<n>:SLEW:LOWer <Level>

Sets the lower voltage threshold. When the signal crosses this level, the slew rate measurement starts or stops depending on the selected slope.

Suffix:

<ev> 1, can be omitted

<n> 1 to 8, depending on instrument model. Index of the analog channel.

Parameters:

<Level> Range: -10 to 10
 Increment: 0.001
 *RST: -0.1
 Default unit: V

Usage: Asynchronous command

Manual operation: See "[Lower level](#)" on page 151

TRIGger:EVENT<ev>:LEVel<n>:SLEW:UPPer <Level>

Sets the upper voltage threshold. When the signal crosses this level, the slew rate measurement starts or stops depending on the selected slope.

Suffix:

<ev> 1, can be omitted
 <n> 1 to 8, depending on instrument model. Index of the analog channel.

Parameters:

<Level> Range: -10 to 10
 Increment: 0.001
 *RST: 0.1
 Default unit: V

Usage: Asynchronous command

Manual operation: See "[Upper level](#)" on page 151

TRIGger:EVENT<ev>:SLEW:DELTA <TimeDelta>

Defines a time range around the given slew rate.

Suffix:

<ev> 1, can be omitted

Parameters:

<TimeDelta> Range: 0 to 10
 Increment: 1E-07
 *RST: 0
 Default unit: s

Usage: Asynchronous command

Manual operation: See "[±Delta](#)" on page 152

TRIGger:EVENT<ev>:SLEW:RANGe <RangeMode>

Selects how the time limit for the slew rate is defined. The time measurement starts when the signal crosses the first trigger level - the upper or lower limit depending on the selected slope. The measurement stops when the signal crosses the second level.

You can select the rate with `TRIGger:EVENT<ev>:SLEW:RATE` and set the delta with `TRIGger:EVENT<ev>:SLEW:DELTA`.

Suffix:

<ev> 1, can be omitted

Parameters:

<RangeMode> INSRange | OUTRange | LTHan | GTHan

INSRange

Triggers on pulses inside a given range. The range is defined by the slew rate $\pm\delta$.

OUTRange

Triggers on pulses outside a given range. The range is defined by the slew rate $\pm\delta$.

LTHan

Triggers on pulses shorter than the given slew rate.

GTHan

Triggers on pulses longer than the given slew rate.

*RST: GTHan

Usage: Asynchronous command

Manual operation: See "[Range](#)" on page 152

TRIGger:EVENT<ev>:SLEW:RATE <Time>

For `TRIGger:EVENT<ev>:SLEW:RATE = INSRange` and `OUTRange`, the slew rate defines the center of a range which is defined by the limits " $\pm\Delta$ ".

For `TRIGger:EVENT<ev>:SLEW:RATE = LTHan` and `GTHan`, the slew rate defines the maximum and minimum slew rate limits, respectively. When the signal crosses this level, the slew rate measurement starts or stops depending on the selected slope (see `TRIGger:EVENT<ev>:SLEW:SLOPe`).

Suffix:

<ev> 1, can be omitted

Parameters:

<Time> Range: 1E-10 to 10000
Increment: 1E-07
*RST: 1E-10
Default unit: s

Usage: Asynchronous command

Manual operation: See "[Slew rate](#)" on page 152

TRIGger:EVENT<ev>:SLEW:SLOPe <Slope>

Sets the edge direction for the trigger.

| | |
|--------------------------|---|
| Suffix: | |
| <ev> | 1, can be omitted |
| Parameters: | |
| <Slope> | POSitive NEGative EITHer |
| | *RST: POSitive |
| Usage: | Asynchronous command |
| Manual operation: | See " Slope " on page 151 |

17.9.10 Trigger mode, holdoff

| | |
|--------------------------------|-----|
| TRIGger:MODE..... | 510 |
| TRIGger:FORCe..... | 510 |
| TRIGger:HOLDoff:MODE..... | 511 |
| TRIGger:HOLDoff:AUTotime?..... | 511 |
| TRIGger:HOLDoff:SCALing..... | 512 |
| TRIGger:HOLDoff:EVENTs..... | 512 |
| TRIGger:HOLDoff:MAX..... | 512 |
| TRIGger:HOLDoff:MIN..... | 513 |
| TRIGger:HOLDoff:TIME..... | 513 |

TRIGger:MODE <TriggerMode>

Sets the trigger mode which determines the behavior of the instrument with and without a trigger event.

Parameters:

<TriggerMode> AUTO | NORMal | FREerun

AUTO

The instrument triggers repeatedly after a time interval if the trigger conditions are not fulfilled. If a real trigger occurs, it takes precedence. The time interval depends on the time base.

NORMal

The instrument acquires a waveform only if a trigger occurs.

FREerun

The instrument triggers after a very short time interval - faster than in AUTO mode. Real triggers are ignored.

*RST: AUTO

Usage: Asynchronous command

Manual operation: See "[Trigger mode](#)" on page 153

TRIGger:FORCe

Provokes an immediate single acquisition. Force the trigger if the acquisition is running in normal mode and no valid trigger occurs. Thus, you can confirm that a signal is available and use the waveform display to determine how to trigger on it.

- Usage:** Setting only
Asynchronous command
- Manual operation:** See "[Force trigger](#)" on page 154

TRIGger:HOLDoff:MODE <Mode>

Selects the method to define the holdoff condition.

The trigger holdoff defines when the next trigger after the current will be recognized. Thus, it affects the next trigger to occur after the current one. Holdoff helps to obtain stable triggering when the oscilloscope is triggering on undesired events.

Holdoff settings are not available if the trigger source is an external trigger input or serial bus, and if you trigger on a sequence of events.

Parameters:

<Mode>

TIME | EVENTs | RANDom | AUTO | OFF

TIME

Defines the holdoff directly as a time period. The next trigger occurs only after the holdoff time has passed, which is defined using [TRIGger:HOLDoff:TIME](#)).

EVENTs

Defines the holdoff as a number of trigger events. The next trigger occurs only when this number of events is reached. The number of triggers to be skipped is defined with [TRIGger:HOLDoff:EVENTs](#).

RANDom

Defines the holdoff as a random time limited by [TRIGger:HOLDoff:MIN](#) and [TRIGger:HOLDoff:MAX](#). For each acquisition cycle, the instrument selects a new random holdoff time from the specified range.

AUTO

The holdoff time is calculated automatically based on the current horizontal scale.

OFF

No holdoff

*RST: OFF

- Usage:** Asynchronous command
- Manual operation:** See "[Holdoff mode](#)" on page 154

TRIGger:HOLDoff:AUTotime?

Returns the resulting holdoff time, if [TRIGger:HOLDoff:MODE](#) is set to AUTO: *Auto time = Auto time scaling * Horizontal scale*. The auto time scaling factor is defined with [TRIGger:HOLDoff:SCALing](#).

Return values:

<AutoTime> Range: 1E-07 to 10
 Increment: 0.0002
 *RST: 0.001
 Default unit: s

Usage: Query only
 Asynchronous command

Manual operation: See "[Holdoff mode](#)" on page 154

TRIGger:HOLDoff:SCALing <AutoTimeScI>

Sets the auto time scaling factor that the horizontal scale is multiplied with, if [TRIGger:HOLDoff:MODETRIGger:HOLDoff:MODE](#) is set to AUTO.

*Auto time = Auto time scaling * Horizontal scale*

The next trigger occurs only after this time has passed.

Parameters:

<AutoTimeScI> Range: 0.001 to 1000
 Increment: 1
 *RST: 0.5

Usage: Asynchronous command

Manual operation: See "[Holdoff mode](#)" on page 154

TRIGger:HOLDoff:EVENTs <Events>

Defines the number of triggers to be skipped, if [TRIGger:HOLDoff:MODETRIGger:HOLDoff:MODE](#) is set to [EVENTs](#). The next trigger only occurs when this number of events is reached.

Parameters:

<Events> Range: 1 to 2147483647
 Increment: 10
 *RST: 1

Usage: Asynchronous command

Manual operation: See "[Holdoff mode](#)" on page 154

TRIGger:HOLDoff:MAX <RandomMaxTime>

Defines the upper limit for the random time holdoff, if [TRIGger:HOLDoff:MODE](#) [TRIGger:HOLDoff:MODETRIGger:HOLDoff:MODE](#) is set to [RANDom](#).

Parameters:

<RandomMaxTime> Range: 1E-07 to 10
 Increment: 0.0002
 *RST: 0.002
 Default unit: s

Usage: Asynchronous command

Manual operation: See "Holdoff mode" on page 154

TRIGger:HOLDoff:MIN <RandomMinTime>

Defines the lower limit for the random time holdoff, if TRIGger:HOLDoff:MODE
TRIGger:HOLDoff:MODETRIGger:HOLDoff:MODE is set to RANDom.

Parameters:

<RandomMinTime> Range: 1E-07 to 5
Increment: 0.0002
*RST: 0.001
Default unit: s

Usage: Asynchronous command

Manual operation: See "Holdoff mode" on page 154

TRIGger:HOLDoff:TIME <Time>

Defines the holdoff time period, if TRIGger:HOLDoff:MODE is set to TIME. The next trigger occurs only after this time has passed.

Parameters:

<Time> Range: 1E-07 to 10
Increment: 0.0002
*RST: 0.001
Default unit: s

Usage: Asynchronous command

Manual operation: See "Holdoff mode" on page 154

17.9.11 Hysteresis

| | |
|-----------------------------------|-----|
| TRIGger:NOISe<m>:ABSolute..... | 513 |
| TRIGger:NOISe<m>:EFFective?..... | 514 |
| TRIGger:NOISe<m>:MODE..... | 514 |
| TRIGger:NOISe<m>:PERDivision..... | 514 |
| TRIGger:NOISe<m>:RELative..... | 515 |
| TRIGger:NOISe<m>[:STATE]..... | 515 |

TRIGger:NOISe<m>:ABSolute <Absolute>

Defines a range in absolute values around the trigger level. If the signal oscillates inside this range and thus crosses the trigger level, no trigger event occurs.

Suffix:

<m> 1 to 8, depending on instrument model. Index of the analog channel.

Parameters:

<Absolute>

Usage: Asynchronous command**Manual operation:** See "[Absolute hysteresis](#)" on page 156**TRIGger:NOISe<m>:EFFective?**

Returns the hysteresis that is set by the instrument in automatic hysteresis mode.

Suffix:

<m> 1 to 8, depending on instrument model. Index of the analog channel.

Return values:

<Effective> numeric value

Usage: Query only
Asynchronous command**Manual operation:** See "[HW hysteresis](#)" on page 155**TRIGger:NOISe<m>:MODE <Mode>**

Selects whether the hysteresis is defined in absolute or relative values. The setting is available only in manual hysteresis mode.

Suffix:

<m> 1 to 8, depending on instrument model. Index of the analog channel.

Parameters:

<Mode> ABS | REL

Usage: Asynchronous command**Manual operation:** See "[Hysteresis mode](#)" on page 155**TRIGger:NOISe<m>:PERDivision <InDivision>**

Defines a range in divisions around the trigger level in division units. If the signal oscillates inside this range and crosses the trigger level thereby, no trigger event occurs.

Suffix:

<m> 1 to 8, depending on instrument model. Index of the analog channel.

Parameters:<InDivision> Range: 0 to 5
Increment: 0.01
*RST: 0
Default unit: div**Usage:** Asynchronous command

Manual operation: See "[Relative hysteresis](#)" on page 156

TRIGger:NOISe<m>:RELative <Relative>

Defines a range in divisions around the trigger level as percentage. If the signal oscillates inside this range and crosses the trigger level thereby, no trigger event occurs.

Suffix:

<m> 1 to 8, depending on instrument model. Index of the analog channel.

Parameters:

<Relative> Range: 0 to 50
 Increment: 1
 *RST: 0
 Default unit: %

Usage: Asynchronous command

Manual operation: See "[Relative hysteresis](#)" on page 156

TRIGger:NOISe<m>[:STATe] <Mode>

Selects how the hysteresis is set.

Suffix:

<m> 1 to 8, depending on instrument model. Index of the analog channel.

Parameters:

<Mode> AUTO | MANual

AUTO

Automatic mode is the recommended mode. The hysteresis is set by the instrument to reject the internal noise of the instrument.

MANual

The hysteresis is defined with [TRIGger:NOISe<m>:ABSolute](#) or [TRIGger:NOISe<m>:RELative](#).

Usage: Asynchronous command

17.9.12 Channel filter

| | |
|--|-----|
| TRIGger:FILTermode | 515 |
| TRIGger:LFReject | 516 |
| TRIGger:RFReject | 516 |

TRIGger:FILTermode <Mode>

Selects the filter mode for the trigger channel.

Parameters:

<Mode> OFF | LFReject | RFReject
 *RST: OFF

Usage: Asynchronous command

Manual operation: See ["Trigger filter mode"](#) on page 156

TRIGger:LFReject <Bandwidth>

Sets the limit frequency limit for the highpass filter of the trigger signal. Frequencies lower than this value are rejected, higher frequencies pass the filter.

Parameters:

<Bandwidth> Range: 50 kHz
 *RST: 50 kHz
 Default unit: Hz

Usage: Asynchronous command

Manual operation: See ["LF reject BW"](#) on page 157

TRIGger:RFReject <Bandwidth>

Sets the limit frequency limit for the lowpass filter of the trigger signal. Frequencies higher than this value are rejected, lower frequencies pass the filter.

Parameters:

<Bandwidth> Range: 1E+3 to 500E+6
 Increment: 1000
 *RST: 1E+6
 Default unit: Hz

Usage: Asynchronous command

Manual operation: See ["RF reject BW"](#) on page 157

17.9.13 Actions on trigger

| | |
|--|-----|
| TRIGger:ACTions:OUT:STATe | 516 |
| TRIGger:ACTions:OUT:SOURce | 517 |
| TRIGger:ACTions:OUT:DELay | 517 |
| TRIGger:ACTions:OUT:PLENgtH | 517 |
| TRIGger:ACTions:OUT:POLarity | 517 |

TRIGger:ACTions:OUT:STATe <State>

Activates the outgoing pulse on the [Trigger Out] connector on the rear panel.

Parameters:

<State> ON | OFF
 *RST: OFF

Usage: Asynchronous command

Manual operation: See ["Trigger out"](#) on page 157

TRIGger:ACTions:OUT:SOURce <SignalSource>

Defines when the trigger out signal is initiated: at the trigger point, when waiting for the trigger, or when the post-trigger time is finished.

Parameters:

<SignalSource> TRIG | TRIGGER | POST | POSTTRIGGER | WAIT | WAITTRIGGER
 TRIG = TRIGGER, POST = POSTTRIGGER, WAIT = WAIT-TRIGGER
 *RST: TRIG

Usage: Asynchronous command

Manual operation: See ["Signal source"](#) on page 158

TRIGger:ACTions:OUT:DELay <Delay>

Defines the delay of the first pulse edge to the trigger point. The minimum delay is 600 ns.

Parameters:

<Delay> Range: 8E-07 to 1
 Increment: 4E-09
 *RST: 8E-07
 Default unit: s

Usage: Asynchronous command

Manual operation: See ["Delay"](#) on page 158

TRIGger:ACTions:OUT:PLENght <PulseLength>

Sets the length of the trigger out pulse.

Parameters:

<PulseLength> Range: 1.6E-08 to 0.05
 Increment: 1.6E-08
 *RST: 9.6E-08
 Default unit: s

Usage: Asynchronous command

Manual operation: See ["Pulse length"](#) on page 158

TRIGger:ACTions:OUT:POLarity <Polarity>

Sets the polarity of the trigger out pulse, which is the direction of the first pulse edge.

Parameters:

<Polarity> POSitive | NEGative
 *RST: POSitive

Usage: Asynchronous command

Manual operation: See "Polarity" on page 158

17.10 Waveform analysis

Some of the commands in the following chapter are asynchronous. An overlapping or asynchronous command does not automatically finish executing before the next command starts executing. If overlapping commands must be executed in a defined order, e.g. to avoid wrong measurement results, they must be serviced sequentially.

To prevent an overlapping execution of commands, one of the commands *OPC, *OPC? or *WAI can be used after the command or a command set.

For more information, see:

- www.rohde-schwarz.com/rc-via-scpi, chapter "Command sequence and synchronization"
- [Zoom](#)..... 518
- [Mathematics](#)..... 526
- [History](#)..... 531
- [Reference waveforms](#)..... 534

17.10.1 Zoom

| | |
|---|-----|
| LAYout<ly>:ZOOM<zo>[:ENABle]..... | 519 |
| LAYout<ly>:ZOOM<zo>:COUNT?..... | 519 |
| LAYout<ly>:ZOOM<zo>:HORizontal:ABSolute:POSition..... | 519 |
| LAYout<ly>:ZOOM<zo>:HORizontal:ABSolute:SPAN..... | 520 |
| LAYout<ly>:ZOOM<zo>:HORizontal:ABSolute:START..... | 520 |
| LAYout<ly>:ZOOM<zo>:HORizontal:ABSolute:STOP..... | 520 |
| LAYout<ly>:ZOOM<zo>:HORizontal:ABSolute:WIDTH..... | 521 |
| LAYout<ly>:ZOOM<zo>:HORizontal:MODE..... | 521 |
| LAYout<ly>:ZOOM<zo>:HORizontal:RELative:POSition..... | 521 |
| LAYout<ly>:ZOOM<zo>:HORizontal:RELative:SPAN..... | 522 |
| LAYout<ly>:ZOOM<zo>:HORizontal:RELative:START..... | 522 |
| LAYout<ly>:ZOOM<zo>:HORizontal:RELative:STOP..... | 522 |
| LAYout<ly>:ZOOM<zo>:HORizontal:RELative:WIDTH..... | 523 |
| LAYout<ly>:ZOOM<zo>:SOURce..... | 523 |
| LAYout<ly>:ZOOM<zo>:VERTical:ABSolute:POSition..... | 523 |
| LAYout<ly>:ZOOM<zo>:VERTical:ABSolute:RANGe..... | 524 |
| LAYout<ly>:ZOOM<zo>:VERTical:ABSolute:SPAN..... | 524 |
| LAYout<ly>:ZOOM<zo>:VERTical:ABSolute:START..... | 524 |
| LAYout<ly>:ZOOM<zo>:VERTical:ABSolute:STOP..... | 524 |
| LAYout<ly>:ZOOM<zo>:VERTical:MODE..... | 525 |

| | |
|---|-----|
| LAYout<ly>:ZOOM<zo>:VERTical:RELative:POSition..... | 525 |
| LAYout<ly>:ZOOM<zo>:VERTical:RELative:START..... | 525 |
| LAYout<ly>:ZOOM<zo>:VERTical:RELative:STOP..... | 526 |
| LAYout<ly>:ZOOM<zo>:VERTical:RELative:WIDTh..... | 526 |
| LAYout<ly>:ZOOM<zo>:VERTical:RELative:SPAN..... | 526 |

LAYout<ly>:ZOOM<zo>[:ENABLE] <State>

Enables the zoom.

Suffix:

<ly> 1...8, index of the SmartGrid layout

<zo> 1...8, index of the zoom

Parameters:

<State> ON | OFF

Example: See [Chapter 17.4.1, "SmartGrid layout with zoom"](#), on page 430.

Usage: Asynchronous command

Manual operation: See ["State"](#) on page 161

LAYout<ly>:ZOOM<zo>:COUNT?

Returns the max number of available zooms.

Suffix:

<ly> 1...8, index of the SmartGrid layout

<zo> 1...8, index of the zoom

Return values:

<Count>

Usage: Query only
Asynchronous command

LAYout<ly>:ZOOM<zo>:HORizontal:ABSolute:POSition <Center>

Defines the x-value of the centerpoint of the zoom area in absolute values.

Suffix:

<ly> 1...8, index of the SmartGrid layout

<zo> 1...8, index of the zoom

Parameters:

<Center> Range: -1E+26 to 1E+26
Increment: 0.01
*RST: 0

Usage: Asynchronous command

Manual operation: See ["Position range"](#) on page 162

**LAYout<ly>:ZOOM<zo>:HORizontal:ABSolute:SPAN **

Defines the width of the zoom area in absolute values.

Suffix:

<ly> 1...8, index of the SmartGrid layout

<zo> 1...8, index of the zoom

Parameters:

 Range: 0 to 1E+26

Increment: 0.01

*RST: 0.01

Usage: Asynchronous command

Manual operation: See "[Position range](#)" on page 162

LAYout<ly>:ZOOM<zo>:HORizontal:ABSolute:START <Start>

Defines the lower limit of the zoom area on the x-axis in absolute values.

Suffix:

<ly> 1...8, index of the SmartGrid layout

<zo> 1...8, index of the zoom

Parameters:

<Start> Range: -1E+26 to 1E+26

Increment: 0.01

*RST: 0.01

Usage: Asynchronous command

Manual operation: See "[Start Stop](#)" on page 162

LAYout<ly>:ZOOM<zo>:HORizontal:ABSolute:STOP <Stop>

Defines the upper limit of the zoom area on the x-axis in absolute values.

Suffix:

<ly> 1...8, index of the SmartGrid layout

<zo> 1...8, index of the zoom

Parameters:

<Stop> Range: -1E+26 to 1E+26

Increment: 0.01

*RST: 0.01

Usage: Asynchronous command

Manual operation: See "[Start Stop](#)" on page 162

**LAYout<ly>:ZOOM<zo>:HORizontal:ABSolute:WIDTh **

Defines the width of the zoom area in absolute values.

Suffix:

<ly> 1...8, index of the SmartGrid layout
<zo> 1...8, index of the zoom

Parameters:

 Range: 0 to 1E+26
Increment: 0.01
*RST: 0.01

Usage: Asynchronous command

LAYout<ly>:ZOOM<zo>:HORizontal:MODE <Mode>

Defines if absolute or relative values are used to specify the x-axis values. Since the zoom area refers to the active signal, relative values ensure that the zoom area remains the same.

Suffix:

<ly> 1...8, index of the SmartGrid layout
<zo> 1...8, index of the zoom

Parameters:

<Mode> ABS | REL
*RST: ABS

Example: See [Chapter 17.4.1, "SmartGrid layout with zoom"](#), on page 430.

Usage: Asynchronous command

Manual operation: See ["Mode"](#) on page 162

LAYout<ly>:ZOOM<zo>:HORizontal:RELative:POSition <RelativeCenter>

Defines the x-value of the centerpoint of the zoom area in relative values.

Suffix:

<ly> 1...8, index of the SmartGrid layout
<zo> 1...8, index of the zoom

Parameters:

<RelativeCenter> Relative position of the centerpoint (x-value)
Range: 0 to 100
Increment: 0.1
*RST: 100
Default unit: %

Usage: Asynchronous command

Manual operation: See ["Position range"](#) on page 162

LAYout<ly>:ZOOM<zo>:HORizontal:RELative:SPAN <RelativeSpan>

Defines the width of the zoom area in relative values.

Suffix:

<ly> 1...8, index of the SmartGrid layout
<zo> 1...8, index of the zoom

Parameters:

<RelativeSpan> Range: 1E-15 to 100
Increment: 0.1
*RST: 1
Default unit: %

Usage: Asynchronous command

Manual operation: See ["Position range"](#) on page 162

LAYout<ly>:ZOOM<zo>:HORizontal:RELative:START <RelativeStart>

Defines the lower limit of the zoom area on the x-axis in relative values.

Suffix:

<ly> 1...8, index of the SmartGrid layout
<zo> 1...8, index of the zoom

Parameters:

<RelativeStart> Range: 0 to 100
Increment: 0.1
*RST: 0
Default unit: %

Example: See [Chapter 17.4.1, "SmartGrid layout with zoom"](#), on page 430.

Usage: Asynchronous command

Manual operation: See ["Start Stop"](#) on page 162

LAYout<ly>:ZOOM<zo>:HORizontal:RELative:STOP <RelativeStop>

Defines the upper limit of the zoom area on the x-axis in relative values.

Suffix:

<ly> 1...8, index of the SmartGrid layout
<zo> 1...8, index of the zoom

Parameters:

<RelativeStop> Range: 0 to 100
Increment: 0.1
*RST: 100
Default unit: %

Example: See [Chapter 17.4.1, "SmartGrid layout with zoom"](#), on page 430.

Usage: Asynchronous command
Manual operation: See ["Start Stop"](#) on page 162

LAYout<ly>:ZOOM<zo>:HORizontal:RELative:WIDTh <RelativeSpan>

Defines the width of the zoom area in relative values.

Suffix:
 <ly> 1...8, index of the SmartGrid layout
 <zo> 1...8, index of the zoom

Parameters:
 <RelativeSpan> Range: 1E-15 to 100
 Increment: 0.1
 *RST: 1
 Default unit: %

Usage: Asynchronous command

LAYout<ly>:ZOOM<zo>:SOURce <Diagram>

Indicates which of the waveform diagrams is selected for zooming. The number is displayed on the screen in the middle of each diagram.

Suffix:
 <ly> 1...8, index of the SmartGrid layout
 <zo> 1...8, index of the zoom

Parameters:
 <Diagram> Index of the diagram, which is zoomed.

Example: See [Chapter 17.4.1, "SmartGrid layout with zoom"](#), on page 430.

Usage: Asynchronous command
Manual operation: See ["Diagram"](#) on page 161

LAYout<ly>:ZOOM<zo>:VERTical:ABSolute:POSition <Center>

Defines the y-value of the centerpoint of the zoom area in absolute values.

Suffix:
 <ly> 1...8, index of the SmartGrid layout
 <zo> 1...8, index of the zoom

Parameters:
 <Center> Range: -1E+26 to 1E+26
 Increment: 0.01
 *RST: 0.01

Usage: Asynchronous command

Manual operation: See ["Position range"](#) on page 162

**LAYout<ly>:ZOOM<zo>:VERTical:ABSolute:RANGe **

**LAYout<ly>:ZOOM<zo>:VERTical:ABSolute:SPAN **

Defines the height of the zoom area in absolute values.

Suffix:

<ly> 1...8, index of the SmartGrid layout

<zo> 1...8, index of the zoom

Parameters:

 Range: 0 to 1E+26

Increment: 0.01

*RST: 0.01

Usage: Asynchronous command

Manual operation: See ["Position range"](#) on page 162

LAYout<ly>:ZOOM<zo>:VERTical:ABSolute:STARt <Start>

Defines the lower limit of the zoom area on the y-axis in absolute values.

Suffix:

<ly> 1...8, index of the SmartGrid layout

<zo> 1...8, index of the zoom

Parameters:

<Start> Range: -1E+26 to 1E+26

Increment: 0.01

*RST: 0.01

Usage: Asynchronous command

Manual operation: See ["Start Stop"](#) on page 162

LAYout<ly>:ZOOM<zo>:VERTical:ABSolute:STOP <Stop>

Defines the upper limit of the zoom area on the y-axis in absolute values.

Suffix:

<ly> 1...8, index of the SmartGrid layout

<zo> 1...8, index of the zoom

Parameters:

<Stop> Range: -1E+26 to 1E+26

Increment: 0.01

*RST: 0.01

Usage: Asynchronous command

Manual operation: See ["Start Stop"](#) on page 162

LAYout<ly>:ZOOM<zo>:VERTical:MODE <Mode>

Defines if absolute or relative values are used to specify the y-axis values. Since the zoom area refers to the active signal, relative values ensure that the zoom area remains the same.

Suffix:

<ly> 1...8, index of the SmartGrid layout
 <zo> 1...8, index of the zoom

Parameters:

<Mode> ABS | REL
 *RST: REL

Usage: Asynchronous command

Manual operation: See "[Mode](#)" on page 162

LAYout<ly>:ZOOM<zo>:VERTical:RELative:POSition <RelativeCenter>

Defines the y-value of the centerpoint of the zoom area in relative values.

Suffix:

<ly> 1...8, index of the SmartGrid layout
 <zo> 1...8, index of the zoom

Parameters:

<RelativeCenter> Range: 0 to 100
 Increment: 0.1
 *RST: 50
 Default unit: %

Usage: Asynchronous command

Manual operation: See "[Position range](#)" on page 162

LAYout<ly>:ZOOM<zo>:VERTical:RELative:STARt <RelativeStart>

Defines the lower limit of the zoom area on the y-axis in relative values.

Suffix:

<ly> 1...8, index of the SmartGrid layout
 <zo> 1...8, index of the zoom

Parameters:

<RelativeStart> Range: 0 to 100
 Increment: 0.1
 *RST: 0
 Default unit: %

Usage: Asynchronous command

Manual operation: See "[Start Stop](#)" on page 162

LAYout<ly>:ZOOM<zo>:VERTical:RELative:STOP <RelativeStop>

Defines the upper limit of the zoom area on the x-axis, in relative values.

Suffix:

<ly> 1...8, index of the SmartGrid layout
 <zo> 1...8, index of the zoom

Parameters:

<RelativeStop> Range: 0 to 100
 Increment: 0.1
 *RST: 100
 Default unit: %

Usage: Asynchronous command

Manual operation: See ["Start Stop"](#) on page 162

LAYout<ly>:ZOOM<zo>:VERTical:RELative:WIDTH <RelativeSpan>**LAYout<ly>:ZOOM<zo>:VERTical:RELative:SPAN** <RelativeSpan>

Defines the height of the zoom area in relative values.

Suffix:

<ly> 1...8, index of the SmartGrid layout
 <zo> 1...8, index of the zoom

Parameters:

<RelativeSpan> Range: 1E-15 to 100
 Increment: 0.1
 *RST: 100
 Default unit: %

Usage: Asynchronous command

Manual operation: See ["Position range"](#) on page 162

17.10.2 Mathematics

| | |
|---|-----|
| CALCulate:MATH<m>:STATe..... | 526 |
| CALCulate:MATH<m>[:EXPRession][:DEFine]..... | 527 |
| CALCulate:MATH<m>:VERTical:SCALE[:VALue]..... | 528 |
| CALCulate:MATH<m>:VERTical:OFFSet..... | 528 |
| CALCulate:MATH<m>:ENVSelection..... | 529 |
| CALCulate:MATH<m>:VERTical:SCALE:MODE..... | 529 |
| CALCulate:MATH<m>:DATA:HEADer?..... | 529 |
| CALCulate:MATH<m>:DATA:STYPe?..... | 530 |
| CALCulate:MATH<m>:DATA[:VALues]?..... | 530 |

CALCulate:MATH<m>:STATe <First>

Activates the selected Math channel and displays the defined math waveforms.

Suffix:

<m> 1...8, index of the math waveform

Parameters:

<First> ON | OFF

Usage:

Asynchronous command

Manual operation: See "Display" on page 166**CALCulate:MATH<m>[:EXPRession][:DEFine] <Expression>**

Defines the math expression to be calculated for the specified math channel.

| Operation | <Expression> | Comment |
|--------------------------------|------------------------------|--|
| Addition | "C1+C2" | |
| Subtraction | "C1-C2" | |
| Multiplication | "C1*C2" | |
| Division | "C1/C2" | 0/0 = 0
+1 / 0 = Clip+
-1 / 0 = Clip- |
| Inverting | "-C1" | |
| Absolute value | "Abs(C1)" | |
| Derivation | "Derivation(C1,NoiseReject)" | NoiseReject can get any value between 1 and 5000 points
Default = 50 |
| Integral | "Integral(C1)" | |
| Logarithm (based on 10) | "Log(C1)" | Uses the absolute value of the source in calculation.
Log(0) = Clip - |
| Natural logarithm (based on e) | "Ln(C1)" | Uses the absolute value of the source in calculation.
Log(0) = Clip - |
| Binary logarithm (based on 2) | "Ld(C1)" | Uses the absolute value of the source in calculation.
Log(0) = Clip - |
| Square | "Pow(C1)" | |
| Square root | "Sqrt(C1)" | Uses the absolute value of the source in calculation. |

| Operation | <Expression> | Comment |
|-----------|---|--|
| Rescale | "Rescale(C1,a,b)" | a = scale, default = 1
b = offset, default = 0 |
| FIR | "FIR(Type,C1,Cut-Off,Characteristics)"

Examples:
"FIR(highpass,C1,10000000,Gaussian)"
"FIR(lowpass,C1,10000000,rectangle)" | Type = lowpass, highpass
Cut-Off = limit frequency
Characteristics = Gaussian, rectangle
Cut-Off can get any value between
4 GHz and 1 kHz |

Suffix:

<m> 1...8, index of the math waveform

Parameters:

<Expression> String with regular expression for calculation

Example:

CALC:MATH 'C1*C2'

Defines the multiplication of waveforms channel 1 and channel 2.

Usage:

Asynchronous command

Manual operation: See "[Operator](#)" on page 167

CALCulate:MATH<m>:VERTical:SCALE[:VALue] <VerticalScale>

Sets the scale of the y-axis in the math function diagram. The value is defined as "<unit> per division", e.g. *50 mV/div*. In this case, the horizontal grid lines are displayed in intervals of 50 mV.

Suffix:

<m> 1...8, index of the math waveform

Parameters:

<VerticalScale> Range: 1E-12 to 100E+12
Increment: 1E-05
*RST: 0.5
Default unit: V

Usage:

Asynchronous command

Manual operation: See "[\[Scale\]](#)" on page 39

CALCulate:MATH<m>:VERTical:OFFSet <VerticalOffset>

Sets a voltage offset to adjust the vertical position of the math function on the screen. Negative values move the waveform up, positive values move it down.

Suffix:

<m> 1...8, index of the math waveform

Parameters:

<VerticalOffset> Range: -100E12 to 100E12
 Increment: 0.01
 *RST: 0
 Default unit: div

Usage: Asynchronous command

Manual operation: See "[Vertical offset](#)" on page 169

CALCulate:MATH<m>:ENVSelection <EnvelopeCurve>

Selects the upper or lower part of the input waveform for mathematic calculation, or a combination of both.

Suffix:

<m> 1...8, index of the math waveform

Parameters:

<EnvelopeCurve> MIN | MAX | BOTH
 *RST: BOTH

Usage: Asynchronous command

Manual operation: See "[Envelope wfm selection](#)" on page 168

CALCulate:MATH<m>:VERTical:SCALE:MODE <VertScIMd>

Sets how the vertical scale is adapted to the current measurement results. By default, scaling is done automatically to provide an optimal display. However, if necessary, you can define scaling values manually to suit your requirements.

Suffix:

<m> 1...8, index of the math waveform

Parameters:

<VertScIMd> MANual | AUTO
 *RST: AUTO

Usage: Asynchronous command

Manual operation: See "[Scale mode](#)" on page 169

CALCulate:MATH<m>:DATA:HEADer?

Returns the header of math waveform data. The header contains attributes of the waveform.

Table 17-3: Header data

| Position | Meaning | Example |
|----------|-------------|--------------------------|
| 1 | XStart in s | -9.477E-008 = - 94,77 ns |
| 2 | XStop in s | 9.477E-008 = 94,77 ns |

| Position | Meaning | Example |
|----------|---|---------|
| 3 | Record length of the waveform in Samples | 200000 |
| 4 | Number of values per sample interval. For most waveforms, the result is 1. For envelope waveforms, it is 2. If the number is 2, the number of returned values is twice the number of samples (record length). | 1 |

Suffix:

<m> 1...8, index of the math waveform

Example:

```
CALC:MATH1:DATA:HEAD?
-9.477E-008,9.477E-008,200000,1
```

Usage:

Query only
Asynchronous command

CALCulate:MATH<m>:DATA:STYPe?

Returns the signal type of the source of the math waveform.

Suffix:

<m> 1...8, index of the math waveform

Return values:

<SignalType> SOUR | CORR | MEAS | NONE
 SOURce = normal signal
 CORRection = correlated signal, specific math signal
 MEAsurement = result of a measurement
 NONE = undefined

Usage:

Query only
Asynchronous command

CALCulate:MATH<m>:DATA[:VALues]? [<Offset>],[<Length>]

Returns the data of the math waveform points for transmission from the instrument to the controlling computer. The data can be used in MATLAB, for example.

To set the export format, use [FORMat \[:DATA\]](#).

Suffix:

<m> 1...8, index of the math waveform

Query parameters:

<Offset> Number of offset waveform points to be skipped.

<Length> Number of waveform points to be retrieved.

Return values:

<Data> List of values according to the format and content settings.

Example:

```
:CALCulate:MATH1:DATA:VALues? 100,10
Returns 10 points from the start index 100.
```

Usage: Query only
Asynchronous command

17.10.3 History

| | |
|-----------------------------------|-----|
| ACQUIRE:HISTORY:CURRENT..... | 531 |
| ACQUIRE:HISTORY:PLAY..... | 531 |
| ACQUIRE:HISTORY:REPLAY..... | 531 |
| ACQUIRE:HISTORY:START..... | 532 |
| ACQUIRE:HISTORY:STOP..... | 532 |
| ACQUIRE:HISTORY:TPACq..... | 532 |
| ACQUIRE:HISTORY:TSABbsolute?..... | 532 |
| ACQUIRE:HISTORY:TSDate?..... | 533 |
| ACQUIRE:HISTORY:TSRelative?..... | 533 |
| ACQUIRE:HISTORY:TSReference?..... | 533 |
| ACQUIRE:HISTORY[:STATe]..... | 534 |

ACQUIRE:HISTORY:CURRENT <CurrentAcqIndex>

Accesses a particular acquisition in the memory to display it, or to save it. The newest acquisition always has the index "0". Older acquisitions have a negative index.

Parameters:

<CurrentAcqIndex> Range: -2147483648 to 0
Increment: 1
*RST: 0

Usage: Asynchronous command

Manual operation: See "Current acq" on page 172

ACQUIRE:HISTORY:PLAY

Starts and stops the replay of the history waveforms.

Usage: Event
Asynchronous command

Manual operation: See "Player" on page 172

ACQUIRE:HISTORY:REPLay <AutoRepeat>

If enabled, the replay of the history waveform sequence repeats automatically.

Otherwise, the replay stops at the stop index set with [ACQUIRE:HISTORY:STOP](#) on page 532.

Parameters:

<AutoRepeat> ON | OFF
*RST: OFF

Usage: Asynchronous command

Manual operation: See ["Auto repeat"](#) on page 174

ACQUIRE:HISTORY:START <StartAcqIndex>

Sets the index of the first (oldest) acquisition to be displayed or exported. The index is always negative.

Parameters:

<StartAcqIndex> Range: -2147483648 to 0
 Increment: 1
 *RST: 0

Usage: Asynchronous command

Manual operation: See ["Start acq"](#) on page 172

ACQUIRE:HISTORY:STOP <StopAcqIndex>

Sets the index of the last (newest) acquisition to be displayed or exported. The newest acquisition of the complete acquisition series always has the index "0".

Parameters:

<StopAcqIndex> Range: -2147483648 to 0
 Increment: 1
 *RST: 0

Usage: Asynchronous command

Manual operation: See ["Stop acq"](#) on page 172

ACQUIRE:HISTORY:TPACq <TimePerAcq>

Sets the display time for one acquisition. The shorter the time, the faster the replay is.

Parameters:

<TimePerAcq> Range: 4E-05 to 10
 Increment: 1
 *RST: 0.05
 Default unit: s

Usage: Asynchronous command

Manual operation: See ["Display time"](#) on page 173

ACQUIRE:HISTORY:TSABsolute?

Returns the absolute daytime of the current acquisition ([ACQUIRE:HISTORY:CURRENT](#)).

Return values:

<TimeAbsString> String containing the time and unit

Usage: Query only
Asynchronous command

Manual operation: See ["Time stamp"](#) on page 173

ACQUIRE:HISTORY:TSDATE?

Returns the date of the current acquisition ([ACQUIRE:HISTORY:CURRENT](#)).

Return values:

<DateAbsString> String parameter with acquisition date

Usage: Query only
Asynchronous command

Manual operation: See ["Time stamp"](#) on page 173

ACQUIRE:HISTORY:TSRELATIVE?

Returns the relative time of the current acquisition - the time difference to the newest acquisition (index = 0).

See also: [ACQUIRE:HISTORY:CURRENT](#).

Return values:

<TimeRelativ> Range: -1E+26 to 1E+26
Increment: 1
*RST: 0
Default unit: s

Usage: Query only
Asynchronous command

Manual operation: See ["Time stamp"](#) on page 173

ACQUIRE:HISTORY:TSREFERENCE?

Returns the relative time of the currently selected acquisition and the internal reference time (horizontal alignment) in history view in relation to the acquisition with index 0.

Return values:

<TimeRelIntRef> Range: -1E+26 to 1E+26
Increment: 1
*RST: 0
Default unit: s

Usage: Query only
Asynchronous command

Manual operation: See ["Time stamp"](#) on page 173

ACQuire:HISTory[:STATe] <State>

Enables the history mode and allows you to save history waveforms to file.

Parameters:

<State> ON | OFF
 *RST: OFF

Usage: Asynchronous command

Manual operation: See "[Show history](#)" on page 172

17.10.4 Reference waveforms

- [Setup](#).....534
- [Scaling](#).....537
- [Reference waveform data export](#).....541

17.10.4.1 Setup

| | |
|--|-----|
| REFCurve<rc>:ABORt | 534 |
| REFCurve<rc>:CLEar | 534 |
| REFCurve<rc>:NAME | 535 |
| REFCurve<rc>:OFFSet | 535 |
| REFCurve<rc>:OPEN | 535 |
| REFCurve<rc>:RESTore | 535 |
| REFCurve<rc>:SAVE | 536 |
| REFCurve<rc>:SOURce | 536 |
| REFCurve<rc>:STATe | 536 |
| REFCurve<rc>:UPDate | 537 |

REFCurve<rc>:ABORt

Aborts a running reference waveform export, which was started with [REFCurve<rc>:SAVE](#), or a running reference waveform update, which was started with [REFCurve<rc>:UPDate](#) on page 537.

Suffix:

<rc> 1...8, index of the reference waveform

Usage:

Event
 Asynchronous command

Manual operation: See "[Save](#)" on page 178

REFCurve<rc>:CLEar

The selected reference waveform disappears, its memory is deleted.

Suffix:

<rc> 1...8, index of the reference waveform

Usage: Setting only
Asynchronous command

Manual operation: See "[Clear](#)" on page 178

REFCurve<rc>:NAME <Name>

Defines the name of the reference waveform file to be loaded, saved or deleted.

Suffix:
<rc> 1...8, index of the reference waveform

Parameters:
<Name>

Usage: Asynchronous command

REFCurve<rc>:OFFSet <VerticalOffset>

The vertical offset moves the reference waveform vertically. Enter a value with the unit of the waveform.

Suffix:
<rc> 1...8, index of the reference waveform

Parameters:
<VerticalOffset> Range: -1E+26 to 1E+26
Increment: 1E-06
*RST: 0
Default unit: V

Usage: Asynchronous command

Manual operation: See "[Vertical offset](#)" on page 181

REFCurve<rc>:OPEN

Loads the reference waveform file selected by [REFCurve<rc>:NAME](#) on page 535. Note that reference waveforms can be loaded only from `.ref` files.

Suffix:
<rc> 1...8, index of the reference waveform

Usage: Event
Asynchronous command

Manual operation: See "[Recall](#)" on page 178

REFCurve<rc>:REStore

Applies the original settings of the reference waveform to the horizontal and vertical settings of the selected waveform.

Suffix:
 <rc> 1...8, index of the reference waveform

Usage: Setting only
 Asynchronous command

Manual operation: See ["Restore settings"](#) on page 180

REFCurve<rc>:SAVE

Saves the reference waveform to the file selected by [REFCurve<rc>:NAME](#).

Suffix:
 <rc> 1...8, index of the reference waveform

Usage: Event
 Asynchronous command

Manual operation: See ["Save"](#) on page 178

REFCurve<rc>:SOURCE <Source>

Selects the source waveform from the active waveforms, e.g. input channels, math waveforms, or spectrum.

Suffix:
 <rc> 1...8, index of the reference waveform

Parameters:
 <Source> C1 | C2 | C3 | C4 | C5 | C6 | C7 | C8 | M1 | M2 | M3 | M4 | M5 |
 M6 | M7 | M8 | R1 | R2 | R3 | R4 | R5 | R6 | R7 | R8 | SPEC-
 MAXH1 | SPECMINH1 | SPECNORM1 | SPECAVER1
 Source of the reference waveform.

Usage: Asynchronous command

Manual operation: See ["Source"](#) on page 178

REFCurve<rc>:STATE <State>

Enables the display of the reference waveform in the diagram.

Suffix:
 <rc> 1...8, index of the reference waveform

Parameters:
 <State> ON | OFF
 *RST: OFF

Usage: Asynchronous command

Manual operation: See ["Show"](#) on page 178

REFCurve<rc>:UPDate

Copies the selected source waveform with all its settings to the memory of the reference waveform. If there is a previously defined reference waveform in this memory, it is updated by the current source waveform. If the acquisition is running, the reference waveform is a snapshot.

Suffix:

<rc> 1...8, index of the reference waveform

Usage:

Event
Asynchronous command

Manual operation: See "[Create/update](#)" on page 178

17.10.4.2 Scaling

| | |
|--|-----|
| REFCurve<rc>:AXIS[:XMODE] | 537 |
| REFCurve<rc>:SCALE | 537 |
| REFCurve<rc>:POSITION | 538 |
| REFCurve<rc>:HMODE | 538 |
| REFCurve<rc>:RESCale:HORizontal:FACTor | 538 |
| REFCurve<rc>:RESCale:HORizontal:OFFSet | 539 |
| REFCurve<rc>:RESCale:HORizontal:STATE | 539 |
| REFCurve<rc>:RESCale:VERTical:FACTor | 539 |
| REFCurve<rc>:RESCale:VERTical:OFFSet | 540 |
| REFCurve<rc>:RESCale:VERTical:STATE | 540 |
| REFCurve<rc>:TOORiginal | 540 |
| REFCurve<rc>:VMODE | 541 |

REFCurve<rc>:AXIS[:XMODE] <XAxisMode>

Defines the scaling method for the frequency (x-axis) of the reference curve.

Suffix:

<rc> 1...8, index of the reference waveform

Parameters:

<XAxisMode> LIN | LOG
 LIN: Linear scaling
 LOG: Logarithmic scaling
 *RST: LIN

Usage:

Asynchronous command

REFCurve<rc>:SCALE <VerticalScale>

Sets the vertical scale, which defines the displayed amplitude of the selected waveform.

Suffix:

<rc> 1...8, index of the reference waveform

Parameters:

<VerticalScale> Range: 1E-15 to 1E+26
 Increment: 1E-05
 *RST: 0.5
 Default unit: Unit of the source waveform

Usage: Asynchronous command

Manual operation: See "[Scale]" on page 39

REFCurve<rc>:POSITION <VertPosi>

Available, if **REFCurve<rc>:VMODE** is set to **INDEPENDENT**.

Moves the reference waveform up or down in the diagram.

Suffix:

<rc> 1...8, index of the reference waveform

Parameters:

<VertPosi> Range: -1E+26 to 1E+26
 Increment: 0.02
 *RST: 0
 Default unit: div

Usage: Asynchronous command

Manual operation: See "[Vertical position](#)" on page 181

REFCurve<rc>:HMODE <HorizontalMode>

Selects the coupling of horizontal settings.

Suffix:

<rc> 1...8, index of the reference waveform

Parameters:

<HorizontalMode> ORIGINAL | COUPled
ORIGINAL
 Horizontal scaling and reference point of the source waveform are used.
COUPled
 The current horizontal settings of the diagram are used.
 *RST: ORIGINAL

Usage: Asynchronous command

Manual operation: See "[Mode](#)" on page 183

REFCurve<rc>:RESCale:HORIZONTAL:FACTOR <ScaleFactor>

Sets the horizontal scale factor. A factor greater than 1 stretches the waveform horizontally, a factor lower than 1 compresses the curve.

Suffix:

<rc> 1...8, index of the reference waveform

Parameters:

<ScaleFactor> Range: 1E-14 to 1000000000000000
 Increment: 0.1
 *RST: 1

Usage:

Asynchronous command

Manual operation: See "[Scale factor](#)" on page 183

REFCurve<rc>:RESCale:HORizontal:OFFSet <Offset>

Moves the waveform horizontally. Enter a value with a time unit suitable for the time scale of the diagram.

Positive values shift the waveform to the right, negative values shift it to the left.

Suffix:

<rc> 1...8, index of the reference waveform

Parameters:

<Offset> Range: -5000000 to 5000000
 Increment: 0.01
 *RST: 0
 Default unit: s

Usage:

Asynchronous command

Manual operation: See "[Horizontal offset](#)" on page 183

REFCurve<rc>:RESCale:HORizontal:STATe <State>

If enabled, the horizontal offset and factor are applied to the reference waveform.

Stretching and offset change the display of the waveform independent of the horizontal settings of the source waveform and of the horizontal diagram settings.

Suffix:

<rc> 1...8, index of the reference waveform

Parameters:

<State> ON | OFF
 *RST: OFF

Usage:

Asynchronous command

Manual operation: See "[Enable](#)" on page 183

REFCurve<rc>:RESCale:VERTical:FACTor <ScaleFactor>

Sets the vertical scale factor. A factor greater than 1 stretches the waveform vertically, a factor lower than 1 compresses the curve.

Suffix:

<rc> 1...8, index of the reference waveform

Parameters:

<ScaleFactor> Range: -100000000 to 100000000
 Increment: 0.1
 *RST: 1

Usage: Asynchronous command

Manual operation: See "[Scale factor](#)" on page 182

REFCurve<rc>:RESCale:VERTical:OFFSet <Offset>

The vertical offset moves the reference waveform vertically. Enter a value with the unit of the waveform.

Like vertical offset of a channel waveform, the offset of a reference waveform is subtracted from the measured value. Negative values shift the waveform up, positive values shift it down.

Suffix:

<rc> 1...8, index of the reference waveform

Parameters:

<Offset> Range: -100000000 to 100000000
 Increment: 1E-06
 *RST: 0
 Default unit: V

Usage: Asynchronous command

Manual operation: See "[Vertical offset](#)" on page 182

REFCurve<rc>:RESCale:VERTical:STATe <State>

If enabled, the vertical offset and factor are applied to the reference waveform.

Stretching and offset change the display of the waveform independent of the vertical scale and position.

Suffix:

<rc> 1...8, index of the reference waveform

Parameters:

<State> ON | OFF
 *RST: OFF

Usage: Asynchronous command

Manual operation: See "[Enable](#)" on page 182

REFCurve<rc>:TOORiginal

Available, if [REFCurve<rc>:VMODE](#) is set to INDependent.

Restores the original vertical settings of the reference waveform (vertical scale, position, and offset).

Suffix:

<rc> 1...8, index of the reference waveform

Usage:

Setting only
Asynchronous command

Manual operation: See ["Set to original"](#) on page 181

REFCurve<rc>:VMODE <VerticalMode>

Selects the coupling of vertical settings.

Suffix:

<rc> 1...8, index of the reference waveform

Parameters:

<VerticalMode> COUPled | INDEpendent

COUPled

Vertical position and scale of the source are used.

INDEpendent

Scaling and position can be set specific to the reference waveform.

*RST: INDEpendent

Usage:

Asynchronous command

Manual operation: See ["Mode"](#) on page 180

17.10.4.3 Reference waveform data export

Commands to transmit the data of reference waveforms are listed below. Commands for saving waveform data to file are described in [Chapter 17.11.4, "Waveform export to file"](#), on page 550.

| | |
|---|-----|
| REFCurve<rc>:DATA:STYPe? | 541 |
| REFCurve<rc>:DATA:HEADer? | 542 |
| REFCurve<rc>:DATA[:VALues]? | 542 |

REFCurve<rc>:DATA:STYPe?

Returns the signal type of the source of the reference waveform.

Suffix:

<rc> 1...8, index of the reference waveform

Return values:

<SignalType>

Usage:

Query only
Asynchronous command

REFCurve<rc>:DATA:HEADer?

Returns information on the reference waveform.

Table 17-4: Header data

| Position | Meaning | Example |
|----------|--|--------------------------|
| 1 | XStart in s | -9.477E-008 = - 94,77 ns |
| 2 | XStop in s | 9.477E-008 = 94,77 ns |
| 3 | Record length of the waveform in Samples | 200000 |
| 4 | Number of values per sample interval. Depends on the source waveform from which the reference waveform was created | 1 |

Suffix:

<rc> 1...8, index of the reference waveform

Example:

```
REFC:DATA:HEAD?
-9.477E-008,9.477E-008,200000,1
```

Usage:

Query only
Asynchronous command

REFCurve<rc>:DATA[:VALues]? [<Offset>],[<Length>]

Returns the data of the channel waveform points for transmission from the instrument to the controlling computer. The data can be used in MATLAB, for example.

To set the export format, use [FORMat \[:DATA\]](#) on page 439.

Suffix:

<rc> 1...8, index of the reference waveform

Query parameters:

<Offset> Number of offset waveform points to be skipped.
Range: 0 to m. Limit: $n + m \leq \text{record length}$

<Length> Number of waveform points to be retrieved.
Range: 1 to n. Limit: $n + m \leq \text{record length}$

Return values:

<Data> List of values according to the format and content settings.

Usage:

Query only
Asynchronous command

17.11 Data management

Some of the commands in the following chapter are asynchronous. An overlapping or asynchronous command does not automatically finish executing before the next command starts executing. If overlapping commands must be executed in a defined order, e.g. to avoid wrong measurement results, they must be serviced sequentially.

To prevent an overlapping execution of commands, one of the commands `*OPC`, `*OPC?` or `*WAI` can be used after the command or a command set.

For more information, see:

- www.rohde-schwarz.com/rc-via-sdpi, chapter "Command sequence and synchronization"

17.11.1 Instrument settings

The Mass MEMory subsystem provides commands to access the storage media and to save and reload instrument settings.

File and directory names

The `<file_name>` and `<directory_name>` parameters are strings. Some commands use a fixed directory; for others the `<file_name>` can contain the complete path including the drive name and all subdirectories. If no complete path is specified, the file location is relative to the current directory, queried with `MMEemory:CDIRectory?`. The filename itself may contain the period as a separator for extensions.

File and directory names can be chosen according to Windows™ conventions; the restrictions placed on filenames known from DOS systems do not apply. All letters and numbers are allowed, as well as the special characters `"_"`, `"^"`, `"$"`, `"~"`, `"!"`, `"#"`, `"%"`, `"&"`, `"-"`, `"{"`, `"}"`, `"("`, `)"`, `"@"` and `"'"`. Reserved filenames are CON, AUX, COM1, ..., COM4, LPT1, ..., LPT3, NUL and PRN.

The use of wildcards `?` and `*` is not allowed.

| | |
|--|-----|
| <code>MMEemory:DRIVes?</code> | 544 |
| <code>MMEemory:DCATalog?</code> | 544 |
| <code>MMEemory:DCATalog:LENGth?</code> | 544 |
| <code>MMEemory:CDIRectory</code> | 545 |
| <code>MMEemory:MDIRectory</code> | 545 |
| <code>MMEemory:RDIRectory</code> | 545 |
| <code>MMEemory:CATalog?</code> | 545 |
| <code>MMEemory:CATalog:LENGth?</code> | 546 |
| <code>MMEemory:COpy</code> | 546 |
| <code>MMEemory:MOVe</code> | 547 |
| <code>MMEemory:DELeTe</code> | 547 |
| <code>MMEemory:DATA</code> | 547 |
| <code>MMEemory:ATTRibute</code> | 548 |
| <code>MMEemory:SAV</code> | 548 |
| <code>MMEemory:RCL</code> | 549 |
| <code>MMEemory:STORe:STATe</code> | 549 |

| | |
|---|-----|
| MMEMory:LOAD:STATE | 549 |
| MMEMory:GENerator:RCL | 549 |
| MMEMory:GENerator:SAV | 550 |

MMEMory:DRIVes?

Returns the path list of available drives.

Return values:

<Drive> List of strings, for example:
 Instrument only: "/home/storage/userData"
 Instrument with connected USB flash drive:
 "/home/storage/userData", "/run/media/usb/MYDATA"
 . MYDATA is the partition name, which is also shown in the file explorer.
 Instrument with connected USB flash drive:
 "/home/storage/userData", "/run/media/usb/8AF8-3EBA"
 . 8AF8-3EBA is an example ID. ID is used if the partition does not have a name, or the name cannot be read.

Usage: Query only

MMEMory:DCATalog? [<PathName>]

Returns the subdirectories of the current or of a specified directory.

Query parameters:

<PathName> String parameter to specify the directory. If the directory is omitted, the command queries the contents of the current directory, to be set and queried with [MMEMory:CDIRectory](#).

Return values:

<FileEntry> Names of the subdirectories separated by colons. The first two strings are related to the parent directory.

Example: MMEM:DCAT?

Usage: Query only

MMEMory:DCATalog:LENGth? [<PathName>]

Returns the number of subdirectories of the current or of a specified directory. The number includes the parent directory strings "." and ".." and corresponds to the number of strings returned by the [MMEMory:DCATalog?](#) command.

Query parameters:

<PathName> String parameter to specify the directory. If the directory is omitted, the command queries the contents of the current directory, to be set and queried with [MMEMory:CDIRectory](#).

Return values:

<FileEntryCount> Number of parent directories and subdirectories.

Example: MMEM:DCAT:LENG?
5

Usage: Query only

MMEMory:CDIRectory [<DirectoryName>]

Changes the default directory for file access.

Parameters:

<DirectoryName> String parameter to specify the directory.
*RST: ""

Example: MMEM:CDIR 'home/storage/userData/Waveforms'

Usage: SCPI confirmed

MMEMory:MDIRectory <DirectoryName>

Creates a new directory with the specified name.

Setting parameters:

<DirectoryName> String parameter to specify the new directory. If the path consists of several subdirectories, the complete tree is created if necessary.

Example: MMEM:MDIR 'home/storage/userData/Waveforms'

Usage: Setting only

MMEMory:RDIRectory <DirectoryName>

Deletes the specified directory.

Setting parameters:

<DirectoryName> String parameter to specify the directory to be deleted. This directory must be empty, otherwise it is not deleted.

Example: MMEM:RDIR 'home/storage/userData/Test'

Usage: Setting only

MMEMory:CATalog? [<PathName>][, <Format>]

Returns a list of files contained in the specified directory. The result corresponds to the number of files returned by the MMEMory:CATalog:LENGth command.

Query parameters:

<PathName> String parameter to specify the directory. If the directory is omitted, the command queries directory specified with [MMEMory:CDIRectory](#).

| | |
|-----------------------|--|
| <Format> | ALL WTIME
ALL: Extended result including file, date, time and attributes
WTIME: Extended result including file, date, time |
| Return values: | |
| <UsedMemory> | Total amount of storage currently used in the directory, in bytes. |
| <FreeMemory> | Total amount of storage available in the directory, in bytes. |
| <FileEntry> | All files and subdirectories of the directory are listed with their filename, format and size in bytes. The first two strings are related to the parent directory. |
| Example: | <pre>MMEM:CAT? 'home/storage/userData' 529479,1831777894400,".",DIR,0","..",DIR,0", "Backup,DIR,0","CSS,DIR,0","DATEN,DIR,0", "Commands.jar,BIN,529479","FAVORITES,DIR,0", "LOG,DIR,0","DATA,DIR,0","test,DIR,0", "TotalCMD,DIR,0"</pre> |
| Usage: | Query only
SCPI confirmed |

MMEMory:CATalog:LENGth? [<PathName>]

Returns the number of files and subdirectories of the current or specified directory. The number includes the parent directory strings "." and ".." and it corresponds to the number of <FileEntry> strings returned by the [MMEMory:CATalog?](#) command.

Query parameters:

<PathName>	String parameter, directory to be queried. If the directory is omitted, the current directory is queried, specified with MMEMory:CDIRectory .
------------	---

Return values:

<Count>	Number of files and subdirectories including parent directory entries.
---------	--

Example:

```
MMEM:CDIR 'home/storage/userData'
MMEM:CAT:LENG?
11
```

Usage: Query only

MMEMory:COPIY <FileSource>[, <FileDestination>]

Copies an existing file to a new file.

Setting parameters:

<FileSource>	String parameter. Contains name and path of the file to be copied. Wildcards (* and ?) are allowed.
--------------	---

<FileDestination> String parameter. Contains name and path of the new file. If the file already exists, it is overwritten without notice. If no file destination is specified, the source file is written to the current directory specified with [MMEMemory:CDIRectory](#).

Usage: Setting only
SCPI confirmed

MMEMemory:MOVE <FileSource>, <FileDestination>

Moves the specified file to a new location on the same drive and renames it.

Setting parameters:

<FileSource> String parameter, contains name and path of the file to be copied. Wildcards (* and ?) are allowed. Therefore, specify a directory for <FileDestination>. Renaming is not possible.

<FileDestination> String parameter. Contains name and path of the new file. If no path is specified, the <FileSource> directory is used - the file is renamed.

Usage: Setting only
SCPI confirmed

MMEMemory:DELeTe <FileName>

Removes the specified file/files. To delete directories, use [MMEMemory:RDIRectory](#).

Setting parameters:

<FileName> String parameter to specify the name and directory of the file to be removed. Wildcards (* and ?) are allowed. If no path is defined, the current directory is used, specified with [MMEMemory:CDIRectory](#).

Example: `MMEM:DEL '* .CFG'`
Deletes all CFG files from the current directory.

Usage: Setting only
SCPI confirmed

MMEMemory:DATA <FileName>, <Data>

MMEMemory:DATA? <FileName>

Stores data in the specified file to the storage location specified using [MMEMemory:CDIRectory](#).

Parameters:**<Data>** <block>

488.2 block data format. The delimiter EOI must be selected to achieve correct data transfer.

The block begins with character '#'. The next digit is the length of the length information, followed by this given number of digits providing the number of bytes in the following binary data.

Parameters for setting and query:**<FileName>** String parameter, the name of the file the data is stored to.**Example:**

```
MMEM:DATA 'abc.txt', #216This is the file
#2: the length information has two digits.
16: the binary data has 16 bytes.
```

Example:

```
MMEM:DATA? 'abc.txt'
Returns the data from file abc.txt.
```

MMEMory:ATTRibute <FileName>, <Attributes>**MMEMory:ATTRibute?** <FileName>

Sets file attributes for the specified file/files. The command can be used for files only.

Setting parameters:

<Attributes> String with attributes and setting information.
 '+' before the attribute: sets the attribute
 '-' before the attribute: deletes the attribute
 'R': read only
 'H': hidden file

Parameters for setting and query:**<FileName>** String parameter, contains name and path of the file. Wildcards (* and ?) are allowed.**Return values:****<FileEntry>** String containing: "<file_name>,<file_attributes>"**MMEMory:SAV** <FileDestination>

Stores the current instrument settings to the specified file.

Waveform generator settings are not included.

This command has the same effect as the combination of *SAV and MMEMory:STORe:STATe.

Parameters:**<FileDestination>** String parameter specifying path and filename of the target file. Wildcards are not allowed.**Usage:** Event

MMEMory:RCL <FileSource>

Restores the instrument settings from the specified file.

The stored instrument settings do not include waveform generator settings.

This command has the same effect as the combination of **MMEMory:LOAD:STATe** and ***RCL**.

Parameters:

'<FileSource>' String parameter specifying the path and filename of the source file. Wildcards are not allowed.

Usage: Event

MMEMory:STORE:STATe <MemoryNumber>, <FileName>

Stores the instrument settings from the specified internal memory to the specified file. To store the current instrument settings to the internal memory, use ***SAV** first.

Setting parameters:

<MemoryNumber> Number of the internal memory
Range: 1 to 99

<FileName> String parameter specifying the complete path and filename of the source file.

Usage: Setting only

MMEMory:LOAD:STATe <MemoryNumber>, <FileName>

Loads the instrument settings from the specified file to the specified internal memory. After the file has been loaded, the settings must be activated using a ***RCL** command.

Setting parameters:

<MemoryNumber> Number of the internal memory
Range: 1 to 99

<FileName> String parameter specifying the complete path and filename of the source file.

Usage: Setting only

MMEMory:GENerator:RCL <FilePath>

Restores the waveform generator settings from the specified file.

Parameters:

<FilePath> String parameter specifying the path and filename of the settings file.

Usage: Asynchronous command

MMEMory:GENerator:SAV <FilePath>

Stores the current waveform generator settings to the specified file.

Parameters:

<FilePath> String parameter specifying path and filename of the settings file.

Usage: Asynchronous command

17.11.2 Saveset

SAVeset:CONFig:PREView <IncludeImage>

If set to **OFF**, the saveset is stored without the preview image to reduce the file size.

Use the command each time before you save a saveset.

Parameters:

<IncludeImage> ON | OFF
*RST: ON

Usage: Asynchronous command

17.11.3 Gen saveset

GENerator:RCL <filePath>

Restores the waveform generator from the specified file.

Parameters:

<filePath> String parameter specifying the path and filename of the source file.

Usage: Asynchronous command

GENerator:SAV <filePath>

Stores the current waveform generator settings to the specified file.

Parameters:

<filePath> String parameter specifying path and filename of the target file.

Usage: Asynchronous command

17.11.4 Waveform export to file

EXPort:WAVeform:NAME.....	551
EXPort:WAVeform:SAVE.....	551
EXPort:WAVeform:ABORt.....	551
EXPort:WAVeform:SCOPE.....	551

EXPort:WAVeform:SOURce	552
EXPort:WAVeform:START	552
EXPort:WAVeform:STOP	553
EXPort:WAVeform:GATE	553
EXPort:WAVeform:CURSorset	553

EXPort:WAVeform:NAME <name>

Sets the path, the filename and the file format of the export file.

Parameters:

<name> String with path and filename with extension *xml, *ref, *csv.
For local storage, the path is
always /home/storage/userData.

Example:

```
EXP:WAV:NAME
'/home/storage/userData/Export_C1.csv'
EXP:WAV:SCOP DISP
EXP:WAV:SAVE
Saves the visible waveform data of channel 1 in xml format
to /home/storage/userData/Export_C1.csv.
```

Usage: Asynchronous command

Manual operation: See "[Save settings](#)" on page 272

EXPort:WAVeform:SAVE

Saves the waveform to the file specified with [EXPort:WAVeform:NAME](#).

Usage: Event
Asynchronous command

Manual operation: See "[Save settings](#)" on page 272

EXPort:WAVeform:ABORT

Aborts a running waveform export, which was started with [EXPort:WAVeform:SAVE](#).

Usage: Event
Asynchronous command

EXPort:WAVeform:SCOPE <Scope>

Defines the part of the waveform record that has to be stored.

Parameters:

<Scope> DISPLAY | ALL | CURSor | GATE | MANual
DISPlay
Waveform data that is displayed in the diagram.

ALL

Complete waveform, which is usually longer than the displayed waveform.

CURSor

Data between the cursor lines if a cursor measurement is defined for the source waveform.

GATE

Data included in the measurement gate if a gated measurement is defined for the source waveform.

MANual

Saves the data between user-defined start and stop values to be set with `EXPort:WAVeform:STARt` and `EXPort:WAVeform:STOP`.

*RST: DISPlay

Example: See [Chapter 17.4.3, "Data transfer in roll mode"](#), on page 435.

Usage: Asynchronous command

Manual operation: See ["Export mode"](#) on page 272

EXPort:WAVeform:SOURce <Source>

Selects the waveform to be exported to file.

Parameters:

<Source> C1 | C2 | C3 | C4 | C5 | C6 | C7 | C8 | D0 | D1 | D2 | D3 | D4 | D5
| D6 | D7 | D8 | D9 | D10 | D11 | D12 | D13 | D14 | D15 | M1 | M2
| M3 | M4 | M5 | M6 | M7 | M8 | R1 | R2 | R3 | R4 | R5 | R6 | R7 |
R8 | SPECMAXH1 | SPECMINH1 | SPECNORM1 | SPECA-
VER1 | HARMonics1 | HARMonics2 | HARMonics3 |

Usage: Asynchronous command

Manual operation: See ["Source"](#) on page 272

EXPort:WAVeform:STARt <Start>

Sets the start time value of the waveform section for export, if `EXPort:WAVeform:SCOPE` on page 551 is set to `Manual`.

Parameters:

<Start> Range: -1E+26 to 1E+26
Increment: 0.01
*RST: 0.01
Default unit: s

Usage: Asynchronous command

Manual operation: See ["Export mode"](#) on page 272

EXPort:WAVeform:STOP <Stop>

Sets the end time value of the waveform section for export, if [EXPort:WAVeform:SCOPE](#) on page 551 is set to `Manual`.

Parameters:

<Stop> Range: -1E+26 to 1E+26
 Increment: 0.01
 *RST: 0.01
 Default unit: s

Usage: Asynchronous command

Manual operation: See "[Export mode](#)" on page 272

EXPort:WAVeform:GATE

Selects the gate to be used for limited data export if [EXPort:WAVeform:SCOPE](#) is set to `GATE`.

Usage: Asynchronous command

Manual operation: See "[Export mode](#)" on page 272

EXPort:WAVeform:CURSorset <Cursorset>

Sets the cursor set to be used for limited data export if [EXPort:WAVeform:SCOPE](#) is set to `CURSor`.

Parameters:

<Cursorset> CURSOR1 | CURSor1 | CURSOR2 | CURSor2 | CURSOR3 |
 CURSor3 | CURSOR4 | CURSor4
 CURSORx = CURSorx

Usage: Asynchronous command

Manual operation: See "[Export mode](#)" on page 272

17.11.5 Results

EXPort:RESult:NAME	553
EXPort:RESult:SAVE	554
EXPort:RESult:SElect:CURSor	554
EXPort:RESult:SElect:MEASurement	554

EXPort:RESult:NAME <FilePath>

Sets the path, the filename and the file format of the export file.

Parameters:

<FilePath> String with path and file name with extension `.csv`.

Usage: Asynchronous command

EXPort:RESult:SAVE

Saves the results to file. The target file is set using `EXPort:RESult:NAME`. To select the results to be exported, use `EXPort:RESult:SElect:CURSor` and `EXPort:RESult:SElect:MEASurement`.

Usage: Event
Asynchronous command

EXPort:RESult:SElect:CURSor <CursorResult>

Includes the current cursor results in the export file.

Parameters:

<CursorResult> ON | OFF
*RST: OFF

Usage: Asynchronous command

EXPort:RESult:SElect:MEASurement <MeasResult>

Includes the current automatic measurement results in the export file.

Parameters:

<MeasResult> ON | OFF
*RST: OFF

Usage: Asynchronous command

17.11.6 Screenshots

The `HCOPY` subsystem and some other commands control the output of display information for documentation purposes. The instrument allows two independent output configurations which can be set separately with the suffix.

Note that the remote mode is intended for maximum performance. Therefore, the display does not follow the remote commands constantly. To get a correct screenshot, turn the display on using `SYSTEM:DISPlay:UPDate`.

<code>HCOPY:DESTination<m></code>	555
<code>MMEMemory:NAME</code>	555
<code>HCOPY:DEVIce<m>:LANGuage</code>	555
<code>HCOPY:DEVIce<m>:INVerse</code>	555
<code>HCOPY:IMMEDIATE<m>:NEXT</code>	556
<code>HCOPY:IMMEDIATE<m>[:DUM]</code>	556
<code>HCOPY:ISBA</code>	556
<code>HCOPY:SSD</code>	557
<code>HCOPY:WBKG</code>	557

HCOPY:DESTination<m> <medium>

Selects the output medium: file or clipboard.

Suffix:

<m> 1..2
Selects the output configuration.

Parameters:

<medium> MMEM | CLIPBOARD
MMEM: saves image to a file.
CLIPBOARD: directs the image to the clipboard.
*RST: MMEM

Usage: Asynchronous command

Manual operation: See ["Directory"](#) on page 282

MMEMory:NAME <FileName>

Defines the filename for a screenshot that is stored to a file.

Parameters:

<FileName> String parameter specifying path and filename of the screenshot.

Example: See [Chapter 17.4.2, "Saving screenshots to file"](#), on page 434.

Usage: SCPI confirmed
Asynchronous command

HCOPY:DEvice<m>:LANGuage <FileFormat>

Defines the file format for output of the screenshot to file.

To set the output to file, use [HCOPY:DESTination<m>](#) with parameter 'MMEM'.

Suffix:

<m> 1..2
Selects the output configuration.

Parameters:

<FileFormat> PNG | JPG
*RST: PNG

Usage: Asynchronous command

HCOPY:DEvice<m>:INVerse <InverseColor>

Inverts the colors of the output, i.e. a dark waveform is shown on a white background.

See also [HCOPY:WBKG](#) and [White background](#).

Suffix:
 <m> 1..2
 Selects the output configuration.

Parameters:
 <InverseColor> ON | OFF
 *RST: OFF

Usage: Asynchronous command

Manual operation: See "Inverse color" on page 282

HCOPY:IMMEDIATE<m>:NEXT

Starts the output of the next display image, depending on the [HCOPY:DESTINATION<m>](#) destination setting.

If the screenshot is saved to a file, the file name used in the last saving process is automatically counted up to the next unused name.

Suffix:
 <m> 1..2
 Selects the output configuration.

Usage: Asynchronous command

HCOPY:IMMEDIATE<m>[:DUM]

Starts the immediate output of the display image, depending on the [HCOPY:DESTINATION<m>](#) destination setting.

To get a correct screenshot of the diagrams, results, and dialog boxes, turn on the display using [SYSTEM:DISPLAY:UPDATE](#).

Suffix:
 <m> 1..2
 Selects the output configuration.

Usage: Event
 Asynchronous command

HCOPY:ISBA <IncludeSignBarScpi>

If enabled, the screenshot shows the signal bar below the diagram area.

Parameters:
 <IncludeSignBarScpi>ON | OFF
 *RST: ON

Usage: Asynchronous command

Manual operation: See "Include signal bar" on page 282

HCOPY:SSD <ShwSetDialogScpi>

If enabled, the currently open dialog box is included in the screenshot.

Parameters:

<ShwSetDialogScpi> ON | OFF

*RST: OFF

Usage: Asynchronous command

Manual operation: See ["Show setup dialog"](#) on page 282

HCOPY:WBKG <WhiteBackground>

Inverts the background color, so you can picture waveforms with normal waveform colors on white background.

If both `HCOPY:WBKG` and `HCOPY:DEVICE<m>:INVERSE` are ON, the instrument inverts the background twice, and it appears black.

Parameters:

<WhiteBackground> ON | OFF

*RST: OFF

Usage: Asynchronous command

Manual operation: See ["White background"](#) on page 282

17.12 Automatic measurements

This chapter contains all remote commands to set up automatic measurements and to analyze the measurement results.

Measurement suffix <mg>

The suffix <mg> indicates the number of the measurement, for which the command takes effect.

17.12.1 General settings

MEASurement<mg>:COUNT?	558
MEASurement<mg>[:ENABLE]	558
MEASurement<mg>:SOURCE	558
MEASurement<mg>:FSRC	558
MEASurement<mg>:SSRC	559
MEASurement<mg>:MAIN	559
MEASurement<mg>:ENVSelect	559

MEASurement<mg>:COUNT?

Returns the maximum number of measurements, which is the maximum value for the <mg> suffix.

Suffix:

<mg> Irrelevant, omit the suffix.

Return values:

<Count> Maximum number of measurements

Usage:

Query only
Asynchronous command

MEASurement<mg>[:ENABLE] <First>

Switches the indicated measurement on or off.

Suffix:

<mg> 1...24, index of the measurement

Parameters:

<First> ON | OFF

Usage:

Asynchronous command

MEASurement<mg>:SOURCE <SignalSource>,[<SignalSource2>]

Sets the source of the measurement.

Suffix:

<mg> 1...24, index of the measurement

Parameters:

<SignalSource> NONE | C1 | C2 | C3 | C4 | C5 | C6 | C7 | C8 | D0 | D1 | D2 | D3 | D4 | D5 | D6 | D7 | D8 | D9 | D10 | D11 | D12 | D13 | D14 | D15 | M1 | M2 | M3 | M4 | M5 | M6 | M7 | M8

<SignalSource2> NONE | C1 | C2 | C3 | C4 | C5 | C6 | C7 | C8 | D0 | D1 | D2 | D3 | D4 | D5 | D6 | D7 | D8 | D9 | D10 | D11 | D12 | D13 | D14 | D15 | M1 | M2 | M3 | M4 | M5 | M6 | M7 | M8

Usage:

Asynchronous command

Manual operation: See "[Source](#)" on page 206

MEASurement<mg>:FSRC <Source>

Defines the first measurement source.

The command is an alternative to [MEASurement<mg>:SOURCE](#).

Suffix:

<mg> 1...24, index of the measurement

Parameters:

<Source> NONE | C1 | C2 | C3 | C4 | C5 | C6 | C7 | C8 | D0 | D1 | D2 | D3 | D4 | D5 | D6 | D7 | D8 | D9 | D10 | D11 | D12 | D13 | D14 | D15 | M1 | M2 | M3 | M4 | M5 | M6 | M7 | M8

Usage: Asynchronous command

MEASurement<mg>:SSRC <Source2>

Defines the second measurement source.

The command is an alternative to [MEASurement<mg>:SOURCE](#).

Suffix:

<mg> 1...24, index of the measurement

Parameters:

<Source2> NONE | C1 | C2 | C3 | C4 | C5 | C6 | C7 | C8 | D0 | D1 | D2 | D3 | D4 | D5 | D6 | D7 | D8 | D9 | D10 | D11 | D12 | D13 | D14 | D15 | M1 | M2 | M3 | M4 | M5 | M6 | M7 | M8

Usage: Asynchronous command

Manual operation: See "[Clock source](#)" on page 209

MEASurement<mg>:MAIN <MeasType>

Defines the measurement that is used as a source for math calculations and result analysis.

Suffix:

<mg> 1...24, index of the measurement

Parameters:

<MeasType> HIGH | LOW | AMPLitude | MAXimum | MINimum | PDELta | MEAN | RMS | STDDev | CRESst | POVershoot | NOVershoot | AREA | RTIME | FTIME | PPULse | NPULse | PERiod | FREQuency | PDCYcle | NDCYcle | CYCarea | CYCMean | CYCRms | CYCStddev | CMAXimum | CMINimum | CPDelta | PULCnt | DELay | PHASe | BWIDth | EDGecount | SETup | HOLD | SHT | SHR | DTOTrigger | SLERising | SLEFalling

Usage: Asynchronous command

MEASurement<mg>:ENVSelect <EnvelopeCurve>

Relevant only for measurements on envelope waveforms. It selects the envelope to be used for measurement.

Prerequisites:

- [ACQUIRE:TYPE](#) on page 475 is set to ENVELOpe.

Suffix:

<mg> 1...24, index of the measurement

Parameters:

<EnvelopeCurve> MIN | MAX | BOTH

MIN

Measures on the lower envelope.

MAX

Measures on the upper envelope.

BOTH

The envelope is ignored, and the waveform is measured as usual.

*RST: BOTH

Usage:

Asynchronous command

Manual operation: See "Envelope" on page 208

17.12.2 Measurement-specific settings

MEASurement<mg>:AMPTime:CSLope.....	560
MEASurement<mg>:AMPTime:ESLope.....	560
MEASurement<mg>:AMPTime:PTCount.....	561
MEASurement<mg>:AMPTime:PSLope.....	561
MEASurement<mg>:AMPTime:DElay<n>:DIRection.....	561
MEASurement<mg>:AMPTime:DTOTrigger<n>:SLOPe.....	562
MEASurement<mg>:AMPTime:DElay<n>:SLOPe.....	562
MEASurement<mg>:GATE.....	563
MEASurement<mg>:REFLevel<sc>:REFerence.....	563

MEASurement<mg>:AMPTime:CSLope <SetHoldClkSlp>

Sets the edge of the clock from which the setup and hold times are measured.

Suffix:

<mg> 1...24, index of the measurement

Parameters:

<SetHoldClkSlp> POSitive | NEGative | EITHer

*RST: POSitive

Usage:

Asynchronous command

Manual operation: See "Clock slope" on page 210

MEASurement<mg>:AMPTime:ESLope <EdgesSlope>

Sets the edge direction to be counted: rising edges, falling edges, or both. The setting is only relevant for edge count measurement `MEASurement<mg>:MAIN` is set to `EDGecount`.

Suffix:
 <mg> 1...24, index of the measurement

Parameters:
 <EdgesSlope> POSitive | NEGative | EITHer
 *RST: POSitive

Usage: Asynchronous command

Manual operation: See "[Edges slope](#)" on page 208

MEASurement<mg>:AMPTime:PTCount <PulseCount>

Sets the number of positive pulses for the pulse train measurement. It measures the duration of N positive pulses from the rising edge of the first pulse to the falling edge of the N-th pulse.

Suffix:
 <mg> 1...24, index of the measurement

Parameters:
 <PulseCount> Range: 1 to 2147483647
 Increment: 1
 *RST: 1

Usage: Asynchronous command

Manual operation: See "[Pulse count](#)" on page 208

MEASurement<mg>:AMPTime:PSLope <PulsesSlope>

Sets the first slope of the pulses to be counted. The setting is only relevant for pulse count measurement ([MEASurement<mg>:MAIN](#) is set to `PULCnt`).

Suffix:
 <mg> 1...24, index of the measurement

Parameters:
 <PulsesSlope> POSitive | NEGative | EITHer
 *RST: POSitive

Usage: Asynchronous command

Manual operation: See "[Pulse slope](#)" on page 208

MEASurement<mg>:AMPTime:DELay<n>:DIRection <EdgeCountDir>

Selects the direction for counting slopes for each source: from the beginning of the waveform, or from the end.

Suffix:
 <mg> 1...24, index of the measurement

<n> 1..2
Selects the source number.

Parameters:

<EdgeCountDir> FRFI | FRLA
FRFI - FRom FIrst, counting starts with the first edge of the waveform.
FRLA - FRom LAst, counting starts with the last edge of the waveform.
*RST: FRFI

Usage: Asynchronous command

Manual operation: See "[Direction](#)" on page 211

MEASurement<mg>:AMPTime:DTOTrigger<n>:SLOPe <DlyTrigSlp>

Sets the edge direction to be used for delay measurement.

Suffix:

<mg> 1...24, index of the measurement

<n> 1..2
Selects the source number.

Parameters:

<DlyTrigSlp> POSitive | NEGative | EITHer
*RST: POSitive

Usage: Asynchronous command

Manual operation: See "[Delay to trigger measurement settings](#)" on page 211

MEASurement<mg>:AMPTime:DELay<n>:SLOPe <Slope>

Sets the edge of each source, between which the delay is measured.

Suffix:

<mg> 1...24, index of the measurement

<n> 1..2
Selects the source number.

Parameters:

<Slope> POSitive | NEGative | EITHer
*RST: POSitive

Usage: Asynchronous command

Manual operation: See "[Slope](#)" on page 211

MEASurement<mg>:GATE <Gate>

Sets the gate of the indicated measurement. Enable a gate before you assign a measurement to it (`GATE<g>:ENABLE =ON`).

The query returns 0, if no gate is assigned.

Suffix:

<mg> 1...24, index of the measurement

Parameters:

<Gate> Number of the gate to be used

Usage: Asynchronous command

Manual operation: See "[Measurements gated by G<x>](#)" on page 198

MEASurement<mg>:REFLevel<sc>:REFerence <RefLevelSet>

Selects the set of reference levels that is used for the measurement and for the indicated source. Each source of the measurement can have its own reference level set.

Suffix:

<mg> 1...24, index of the measurement

<sc> 1...3

Source waveform, to which the reference level set is applied.

Parameters:

<RefLevelSet> Number of the reference level set. Define the reference level set before you use it.

Example:

```
MEASurement1:MAIN DELay
MEASurement1:SOURce C1,C2
MEASurement1:REFLevel1:REFerence 1
MEASurement1:REFLevel2:REFerence 2
```

Measurement 1 is a delay measurement on channel 1 and channel 2. C1 is the first source and uses reference level set 1 (RL1). C2 is the second source and uses reference level set 2 (RL2).

Usage: Asynchronous command

Manual operation: See "[Reference levels](#)" on page 207

17.12.3 Results

MEASurement<mg>:RESult[:ACTual]?.....	564
MEASurement<mg>:RESult:AVG?.....	564
MEASurement<mg>:RESult:NPEak?.....	564
MEASurement<mg>:RESult:PPEak?.....	564
MEASurement<mg>:RESult:RELiability?.....	564
MEASurement<mg>:RESult:RMS?.....	564
MEASurement<mg>:RESult:WFMCount?.....	564

MEASurement<mg>:RESult:EVTCount?	564
MEASurement<mg>:RESult:STDDDev?	564
MEASurement<mg>:RESult:START?	564
MEASurement<mg>:RESult:STOP?	564
MEASurement<mg>:RESult:EVENTs:COUNT?	565
MEASurement<mg>:RESult:EVENTs:START?	565
MEASurement<mg>:RESult:EVENTs:STOP?	565
MEASurement<mg>:RESult:EVENTs:VALue?	566

MEASurement<mg>:RESult[:ACTual]?
MEASurement<mg>:RESult:AVG?
MEASurement<mg>:RESult:NPEak?
MEASurement<mg>:RESult:PPEak?
MEASurement<mg>:RESult:RELIability? [<MeasType>]
MEASurement<mg>:RESult:RMS?
MEASurement<mg>:RESult:WFMCount?
MEASurement<mg>:RESult:EVTCount?
MEASurement<mg>:RESult:STDDDev?

Return the statistic results of the specified measurement. If no parameter is specified, the result of the main measurement is returned. The main measurement is defined using `MEASurement<mg>:MAIN`.

- [:ACTual]: current measurement result
- AVG: average of the measurement results
- EVTCount: number of measurement results in the measurement
- NPEak: negative peak value of the measurement results
- PPEak: positive peak value of the measurement results
- RELIability: reliability of the measurement result
- RMS: RMS value of the measurement results
- STDDDev: standard deviation of the measurement results

Suffix:

<mg> 1...24, index of the measurement

Return values:

<StdDev> Range: -1E+26 to 1E+26
Increment: 1E-10
*RST: 0

Usage:

Query only
Asynchronous command

MEASurement<mg>:RESult:START?
MEASurement<mg>:RESult:STOP?

Return the start and stop times of the specified measurement. The parameter defines the measurement. If no parameter is specified, the result of the main measurement is returned. The main measurement is defined using `MEASurement<mg>:MAIN`.

Suffix:
 <mg> 1...24, index of the measurement

Return values:
 <Stop> Range: -1E+26 to 1E+26
 Increment: 0
 *RST: 0

Usage: Query only
 Asynchronous command

MEASurement<mg>:RESult:EVENTs:COUNT?

Returns the number of measured events in one acquisition.

The command is relevant for measurements of all events, see [MEASurement<mg>:MULTiple](#).

Suffix:
 <mg> 1...24, index of the measurement

Return values:
 <Count> Number of events

Usage: Query only
 Asynchronous command

MEASurement<mg>:RESult:EVENTs:START? <EventIndex>

Returns the start time of the indicated measured event.

The command is relevant for measurements of all events, see [MEASurement<mg>:MULTiple](#).

Suffix:
 <mg> 1...24, index of the measurement

Setting parameters:
 <EventIndex> Index number of the measured event.

Return values:
 <EventStart> Range: -1E+26 to 1E+26
 Increment: 0
 *RST: 0

Usage: Query only
 Asynchronous command

MEASurement<mg>:RESult:EVENTs:STOP? <EventIndex>

Returns the end time of the indicated measured event.

The command is relevant for measurements of all events, see [MEASurement<mg>:MULTiple](#).

Suffix:
 <mg> 1...24, index of the measurement

Setting parameters:
 <EventIndex> Index number of the measured event.

Return values:
 <EventStop> Range: -1E+26 to 1E+26
 Increment: 0
 *RST: 0

Usage: Query only
 Asynchronous command

MEASurement<mg>:RESult:EVENTs:VALue? <MeasResEvtIdx>

Returns the measured value of the indicated measured event.

The command is relevant for measurements of all events, see [MEASurement<mg>:MULTiple](#).

Suffix:
 <mg> 1...24, index of the measurement

Setting parameters:
 <EventIndex> Index number of the measured event.

Return values:
 <EventValue> Range: -1E+26 to 1E+26
 Increment: 1E-10
 *RST: 0

Usage: Query only
 Asynchronous command

17.12.4 Statistics

MEASurement<mg>:STATistics:ARESet	566
MEASurement<mg>:STATistics[:ENABle]	567
MEASurement<mg>:MULTiple	567
MEASurement<mg>:MNOMeas	567

MEASurement<mg>:STATistics:ARESet

Resets the statistics for all measurements.

Suffix:
 <mg> Irrelevant, omit the suffix.

Usage: Setting only
 Asynchronous command

Manual operation: See "[Clear results](#)" on page 212

MEASurement<mg>:STATistics[:ENABLE] <GlobalEnable>

Enables statistics calculation for all measurements.

Suffix:

<mg> Irrelevant, omit the suffix.

Parameters:

<GlobalEnable> ON | OFF
*RST: OFF

Usage: Asynchronous command

Manual operation: See "[Statistics](#)" on page 212

MEASurement<mg>:MULTiple <GlobalMeassAll>

If ON, the measurement is performed repeatedly if the measured parameter occurs several times inside the acquisition or defined gate. All results are included in evaluation, e.g. in statistics. To set the number of results to be considered, use [MEASurement<mg>:MNOMeas](#).

Suffix:

<mg> Irrelevant, omit the suffix.

Parameters:

<GlobalMeassAll> ON | OFF
*RST: OFF

Usage: Asynchronous command

Manual operation: See "[Measure all events](#)" on page 212

MEASurement<mg>:MNOMeas <MaxMeasPerAcq>

Sets the maximum number of measurements per acquisition if [MEASurement<mg>:MULTiple](#) is on. The setting affects all measurements.

Suffix:

<mg> Irrelevant, omit the suffix.

Parameters:

<MaxMeasPerAcq> Range: 2 to 1E6
Increment: 1
*RST: 1E6

Usage: Asynchronous command

Manual operation: See "[Max. No. of events](#)" on page 213

17.12.5 Gate

GATE<g>:ENABle.....	568
GATE<g>:GCOupling.....	568
GATE<g>:CURSor.....	569
GATE<g>:ZDIagram.....	569
GATE<g>:MODE.....	569
GATE<g>:ABSolute:STARt.....	570
GATE<g>:ABSolute:STOP.....	570
GATE<g>:RELative:STARt.....	570
GATE<g>:RELative:STOP.....	570
GATE<g>:SHOW.....	570

GATE<g>:ENABle <First>

Enables the gate.

Suffix:

<g> 1...8, index of the gate

Parameters:

<First> ON | OFF

Usage: Asynchronous command

Manual operation: See "[+](#) Add" on page 197

GATE<g>:GCOupling <CouplingMode>

The gate coupling mode selects how the gate area is defined.

Suffix:

<g> 1...8, index of the gate

Parameters:

<CouplingMode> MANual | CURSor | ZOOM | SPECTrum

MANual

Manually define the gate with a user-defined start and stop values.

CURSor

Cursor coupling is available if a cursor is defined. The gate area is defined by the cursor lines of an active cursor measurement.

ZOOM

Zoom coupling is available if a zoom is defined. The gate area is defined identically to the zoom area - if you change the zoom, the gate changes as well.

SPECTrum

Spectrum coupling is available if a spectrum is enabled.

*RST: MANual

Usage: Asynchronous command

Manual operation: See "[Coupling mode](#)" on page 198

GATE<g>:CURSor <Cursorset>

Available for `GATE<g>:GCoupling = CURSor`.

Selects the cursor set to be used for measurement gating. The gate area is defined by the cursor lines.

Suffix:

<g> 1...8, index of the gate

Parameters:

<Cursorset> CURSOR1 | CURSor1 | CURSOR2 | CURSor2 | CURSOR3 |
CURSor3 | CURSOR4 | CURSor4
CURSORx = CURSorx
*RST: CURSOR1

Usage: Asynchronous command

Manual operation: See "[Coupling mode](#)" on page 198

GATE<g>:ZDiagram <SignalSource>,[<SignalSource2>]

GATE<g>:ZDiagram? <SignalSource>

Available for `GATE<g>:GCoupling = ZOOM`.

The gate area is defined identically to the zoom area for the selected zoom diagram.

Suffix:

<g> 1...8, index of the gate

Parameters:

<SignalSource2>

Parameters for setting and query:

<SignalSource>

Usage: Asynchronous command

Manual operation: See "[Coupling mode](#)" on page 198

GATE<g>:MODE <Mode>

Selects if the gate settings are configured using absolute or relative values.

Suffix:

<g> 1...8, index of the gate

Parameters:

<Mode> ABS | REL
*RST: ABS

Usage: Asynchronous command

Manual operation: See "Mode" on page 198

GATE<g>:ABSolute:START <Start>

GATE<g>:ABSolute:STOP <Stop>

Define the absolute start and end values for the gate, respectively.

Available, if `GATE<g>:GCoupling = MANUa1` and `GATE<g>:MODE =ABS`.

Suffix:

<g> 1...8, index of the gate

Parameters:

<Stop> Range: -1E+26 to 1E+26
Increment: 0.01
*RST: 0.01

Usage: Asynchronous command

Manual operation: See "Mode" on page 198

GATE<g>:RELative:START <RelativeStart>

GATE<g>:RELative:STOP <RelativeStop>

Define the relative start and end values for the gate, respectively.

Available, if `GATE<g>:GCoupling = MANUa1` and `GATE<g>:MODE =REL`.

Suffix:

<g> 1...8, index of the gate

Parameters:

<RelativeStop> Range: 0 to 100
Increment: 0.1
*RST: 100
Default unit: %

Usage: Asynchronous command

Manual operation: See "Mode" on page 198

GATE<g>:SHOW <DisplayState>

If enabled, the gate area is indicated in the source diagram.

Suffix:

<g> 1...8, index of the gate

Parameters:

<DisplayState> ON | OFF
*RST: ON

Usage: Asynchronous command

17.12.6 Reference levels

REFLevel<rl>:ENABLE.....	571
REFLevel<rl>:LMODe.....	571
REFLevel<rl>:ABSolute:HYSTeresis.....	571
REFLevel<rl>:ABSolute:LLEVel.....	572
REFLevel<rl>:ABSolute:MLEVel.....	572
REFLevel<rl>:ABSolute:ULEVel.....	572
REFLevel<rl>:RELative:HYSTeresis.....	573
REFLevel<rl>:RELative:LOWer.....	573
REFLevel<rl>:RELative:MIDDLE.....	573
REFLevel<rl>:RELative:MODE.....	574
REFLevel<rl>:RELative:UPPer.....	574

REFLevel<rl>:ENABLE <First>

Enables the specified reference level.

Suffix:

<rl> 1...8, index of the reference level set

Parameters:

<First> ON | OFF

Usage:

Asynchronous command

Manual operation: See "RLx" on page 200

REFLevel<rl>:LMODe <LevelMode>

Defines if the reference level is set in absolute or relative values.

Suffix:

<rl> 1...8, index of the reference level set

Parameters:

<LevelMode> ABS | REL
*RST: REL

Usage:

Asynchronous command

Manual operation: See "Level mode" on page 201

REFLevel<rl>:ABSolute:HYSTeresis <HystAbs>

Defines a hysteresis for the middle reference level. A rise or fall from the middle reference value that does not exceed the hysteresis is rejected as noise.

Suffix:

<rl> 1...8, index of the reference level set

Parameters:

<HystAbs> Range: 0 to 1E+26
 Increment: 0.001
 *RST: 0.005
 Default unit: V

Usage: Asynchronous command

Manual operation: See "[Hysteresis](#)" on page 201

REFLevel<rl>:ABSolute:LLEVEL <LowerLevel>

Sets the lower reference level in absolute values. This is required, e.g., to determine a fall.

Suffix:

<rl> 1...8, index of the reference level set

Parameters:

<LowerLevel> Range: -1E+26 to 1E+26
 Increment: 0.001
 *RST: 0
 Default unit: V

Usage: Asynchronous command

Manual operation: See "[Upper level, Middle level, Lower level](#)" on page 201

REFLevel<rl>:ABSolute:MLEVEL <MiddleLevel>

Sets the middle reference level in absolute values.

Suffix:

<rl> 1...8, index of the reference level set

Parameters:

<MiddleLevel> Range: -1E+26 to 1E+26
 Increment: 0.001
 *RST: 0
 Default unit: V

Usage: Asynchronous command

Manual operation: See "[Upper level, Middle level, Lower level](#)" on page 201

REFLevel<rl>:ABSolute:ULEVEL <UpperLevel>

Sets the upper reference level in absolute values. This is required to determine a rise.

Suffix:

<rl> 1...8, index of the reference level set

Parameters:

<UpperLevel> Range: -1E+26 to 1E+26
 Increment: 0.001
 *RST: 0
 Default unit: V

Usage: Asynchronous command

Manual operation: See "[Upper level, Middle level, Lower level](#)" on page 201

REFLevel<rl>:RELative:HYSTerisis <HystRel>

Defines a hysteresis for the middle reference level. A rise or fall from the middle reference value that does not exceed the hysteresis is rejected as noise.

Suffix:

<rl> 1...8, index of the reference level set

Parameters:

<HystRel> Range: 0 to 50
 Increment: 1
 *RST: 10
 Default unit: %

Usage: Asynchronous command

Manual operation: See "[Hysteresis](#)" on page 201

REFLevel<rl>:RELative:LOWer <LowRefLevRel>

Sets the lower relative reference level if [REFLevel<rl>:RELative:MODE](#) is set to USER.

Suffix:

<rl> 1...8, index of the reference level set

Parameters:

<LowRefLevRel> Range: -100 to 200
 Increment: 1
 *RST: 10
 Default unit: %

Usage: Asynchronous command

Manual operation: See "[Upper level, Middle level, Lower level](#)" on page 201

REFLevel<rl>:RELative:MIDDLE <MidRefLevRel>

Sets the middle relative reference level if [REFLevel<rl>:RELative:MODE](#) is set to USER.

Suffix:

<rl> 1...8, index of the reference level set

Parameters:

<MidRefLevRel> Range: -100 to 200
 Increment: 1
 *RST: 50
 Default unit: %

Usage: Asynchronous command

Manual operation: See "[Upper level, Middle level, Lower level](#)" on page 201

REFLevel<rl>:RELative:MODE <RelativeLevels>

The lower, middle and upper reference levels, defined as percentages of the high signal level.

Suffix:

<rl> 1...8, index of the reference level set

Parameters:

<RelativeLevels> FIVE | TEN | TWENTy | USER

FIVE

5/50/95

TEN

10/50/90

TWENTy

20/50/80

USER

Set the reference levels to individual values with

[REFLevel<rl>:RELative:LOWer](#), [REFLevel<rl>:RELative:MIDDLE](#), and [REFLevel<rl>:RELative:UPPer](#).

*RST: TEN

Usage: Asynchronous command

Manual operation: See "[Relative levels](#)" on page 201

REFLevel<rl>:RELative:UPPer <UppRefLevRel>

Sets the upper relative reference level if [REFLevel<rl>:RELative:MODE](#) is set to USER.

Suffix:

<rl> 1...8, index of the reference level set

Parameters:

<UppRefLevRel> Range: -100 to 200
 Increment: 1
 *RST: 90
 Default unit: %

Usage: Asynchronous command

Manual operation: See "[Upper level, Middle level, Lower level](#)" on page 201

17.12.7 Tracks

MEASurement<mg>:TRACk[:STATe]	575
MEASurement<mg>:TRACk:AUTO	575
MEASurement<mg>:TRACk:CONTiuous	575
MEASurement<mg>:TRACk:OFFSet	576
MEASurement<mg>:TRACk:SCALE	576
MEASurement<mg>:TRACk:DATA:HEADer?	576
MEASurement<mg>:TRACk:DATA[:VALues]?	577

MEASurement<mg>:TRACk[:STATe] <State>

Enables or disables the track for the selected measurement.

Suffix:

<mg> 1...24, index of the measurement

Parameters:

<State> ON | OFF
*RST: OFF

Usage: Asynchronous command

Manual operation: See "[State](#)" on page 214

MEASurement<mg>:TRACk:AUTO

Sets the vertical scale and the offset of the track, so that the complete height of the diagram is used.

Suffix:

<mg> 1...24, index of the measurement

Usage:

Event
Asynchronous command

Manual operation: See "[Fit to screen](#)" on page 214

MEASurement<mg>:TRACk:CONTiuous <AutoScale>

Performs an automatic scaling whenever the track does not fit in the diagram during the measurement period.

Suffix:

<mg> 1...24, index of the measurement

Parameters:

<AutoScale> ON | OFF
*RST: ON

Usage: Asynchronous command
Manual operation: See "Auto Scale" on page 214

MEASurement<mg>:TRACk:OFFSet <VerticalOffset>

Sets or queries the offset of the track waveform.

If MEASurement<mg>:TRACk:CONTiunous is ON, use the command to query the current value.

If MEASurement<mg>:TRACk:CONTiunous is OFF, the command sets the offset.

Suffix:
 <mg> 1...24, index of the measurement

Parameters:
 <VerticalOffset> Range: -1E+26 to 1E+26
 Increment: 1E-06
 *RST: 0
 Default unit: div

Usage: Asynchronous command
Manual operation: See "Meas offset" on page 215

MEASurement<mg>:TRACk:SCALe <VerticalScale>

Sets or queries the vertical scale of the track diagram.

If MEASurement<mg>:TRACk:CONTiunous is ON, use the command to query the current value.

If MEASurement<mg>:TRACk:CONTiunous is OFF, the command sets the scale.

Suffix:
 <mg> 1...24, index of the measurement

Parameters:
 <VerticalScale> Range: 1E-26 to 1E+26
 Increment: 1E-05
 *RST: 0.5
 Default unit: V/div

Usage: Asynchronous command
Manual operation: See "Meas scale" on page 214

MEASurement<mg>:TRACk:DATA:HEADer?

Returns the header of track data.

Table 17-5: Header data

Position	Meaning	Example
1	XStart, acquisition time before trigger, in s	-5E-008 = - 50 ns
2	XStop, acquisition time after trigger, in s	5E-008 = 50 ns
3	Number of measurement events = number of points in the track waveform	1000
4	Always 1	1

Suffix:

<mg> 1...24, index of the measurement

Usage:

Query only
Asynchronous command

MEASurement<mg>:TRACk:DATA[:VALues]? [<Offset>],[<Length>]

Returns the data of the indicated track waveform for transmission from the instrument to the controlling computer. The data can be used in MATLAB, for example.

Without parameters, the complete waveform is retrieved. Using the offset and length parameters, data can be retrieved in smaller portions, which makes the command faster. If you send only one parameter, it is interpreted as offset, and the data is retrieved from offset to the end of the waveform.

Suffix:

<mg> 1...24, index of the measurement

Query parameters:

<Offset> Number of offset track points, which are ignored in the data transfer.

[<Length>] Number of track points to be retrieved.

Return values:

<Data> List of values according to the format and content settings.

Usage:

Query only
Asynchronous command

17.13 Cursor measurements

Some of the commands in the following chapter are asynchronous. An overlapping or asynchronous command does not automatically finish executing before the next command starts executing. If overlapping commands must be executed in a defined order, e.g. to avoid wrong measurement results, they must be serviced sequentially.

To prevent an overlapping execution of commands, one of the commands *OPC, *OPC? or *WAI can be used after the command or a command set.

For more information, see:

- www.rohde-schwarz.com/rc-via-scp, chapter "Command sequence and synchronization"
- [Cursor setup](#).....578
- [Cursor results](#).....584
- [Peak search using cursors](#).....585
- [Cursor appearance](#).....587

17.13.1 Cursor setup

CURSor<cu>:AOFF	578
CURSor<cu>:COUNT?	578
CURSor<cu>:STATe	579
CURSor<cu>:FUNction	579
CURSor<cu>:SOURce	579
CURSor<cu>:USSource	580
CURSor<cu>:SSource	580
CURSor<cu>:X1Position	580
CURSor<cu>:X2Position	581
CURSor<cu>:Y1Position	581
CURSor<cu>:Y2Position	581
CURSor<cu>:TRACking[:STATe]	582
CURSor<cu>:LABel	582
CURSor<cu>:SIAD	582
CURSor<cu>:XCoupling	582
CURSor<cu>:YCOupling	583
CURSor<cu>:X1ENvelope	583
CURSor<cu>:X2ENvelope	583

CURSor<cu>:AOFF

Switches all cursors off.

Suffix:

<cu> Irrelevant, omit the suffix.

Usage:

Setting only
Asynchronous command

CURSor<cu>:COUNT?

Returns the maximum number of cursor sets, which is the maximum value for the cursor suffix.

Suffix:

<cu> Irrelevant, omit the suffix.

Return values:

<Count> Number of cursor sets

Usage: Query only
Asynchronous command

CURSor<cu>:STATe <State>

Enables the selected cursor measurement.

Suffix:
<cu> 1...4, index of the cursor set

Parameters:
<State> ON | OFF
*RST: OFF

Usage: Asynchronous command

Manual operation: See "[Show cursor](#)" on page 188

CURSor<cu>:FUNCTion <Type>

Defines the cursor type to be used for the measurement.

Suffix:
<cu> 1...4, index of the cursor set

Parameters:
<Type> VERTical | HORizontal | PAIRed
HORizontal
A pair of horizontal cursor lines.
VERTical
A pair of vertical cursor lines.
PAIRed
Both vertical and horizontal cursor line pairs.
*RST: PAIRed

Usage: Asynchronous command

Manual operation: See "[Type](#)" on page 188

CURSor<cu>:SOURce <Source>

Selects the cursor source.

Suffix:
<cu> 1...4, index of the cursor set

Parameters:
<Source> C1 | C2 | C3 | C4 | C5 | C6 | C7 | C8 | D0 | D1 | D2 | D3 | D4 | D5
| D6 | D7 | D8 | D9 | D10 | D11 | D12 | D13 | D14 | D15 | SBUS1 |
SBUS2 | SBUS3 | SBUS4 | M1 | M2 | M3 | M4 | M5 | M6 | M7 |
M8 | SPECMAXH1 | SPECMINH1 | SPECNORM1 | SPECAL-
VER1

Usage: Asynchronous command
Manual operation: See "[Source](#)" on page 189

CURSor<cu>:USSource <UseSource2>

Enables the second cursor source. To select the second source, use CURSor<cu>:SSource.

If enabled, the second cursor lines Cx.2 measure on the second source. Using a second source, you can measure differences between two channels with cursors.

Suffix:
 <cu> 1...4, index of the cursor set

Parameters:
 <UseSource2> ON | OFF
 *RST: OFF

Usage: Asynchronous command
Manual operation: See "[Second source, Source 2](#)" on page 188

CURSor<cu>:SSource <Source2>

Selects the second cursor source.

Suffix:
 <cu> 1...4, index of the cursor set

Parameters:
 <Source2> C1 | C2 | C3 | C4 | C5 | C6 | C7 | C8 | D0 | D1 | D2 | D3 | D4 | D5 | D6 | D7 | D8 | D9 | D10 | D11 | D12 | D13 | D14 | D15 | SBUS1 | SBUS2 | SBUS3 | SBUS4 | M1 | M2 | M3 | M4 | M5 | M6 | M7 | M8 | SPECMAXH1 | SPECMINH1 | SPECNORM1 | SPECAL-VER1

Second source of the cursor measurement.

Usage: Asynchronous command
Manual operation: See "[Second source, Source 2](#)" on page 188

CURSor<cu>:X1Position <X1Position>

Defines the position of the left vertical cursor line.

Suffix:
 <cu> 1...4, index of the cursor set

Parameters:
 <X1Position> Range: 0 to 500
 Increment: 0.1
 *RST: depends on time scale, at 25% of the time axis
 Default unit: s

Usage: Asynchronous command
Manual operation: See "[X1 position, X2 position](#)" on page 189

CURSor<cu>:X2Position <X2Position>

Defines the position of the right vertical cursor line.

Suffix:
 <cu> 1...4, index of the cursor set

Parameters:
 <X2Position> Range: 0 to 500
 Increment: 0.1
 *RST: depends on time scale, at 75% of the time axis
 Default unit: s

Usage: Asynchronous command
Manual operation: See "[X1 position, X2 position](#)" on page 189

CURSor<cu>:Y1Position <YPosition1>

Defines the position of the lower horizontal cursor line.

If [CURSor<cu>:TRACking\[:STATe\]](#) is enabled, the y-positions are set automatically. The query returns the measurement result - the lower vertical value of the waveform.

Suffix:
 <cu> 1...4, index of the cursor set

Parameters:
 <YPosition1> Range: -50 to 50
 Increment: 0.01
 *RST: 0

Usage: Asynchronous command
Manual operation: See "[Y1 position, Y2 position](#)" on page 189

CURSor<cu>:Y2Position <YPosition2>

Defines the position of the upper horizontal cursor line.

If [CURSor<cu>:TRACking\[:STATe\]](#) is enabled, the y-positions are set automatically. The query returns the measurement result - the upper vertical value of the waveform.

Suffix:
 <cu> 1...4, index of the cursor set

Parameters:
 <YPosition2> Range: -50 to 50
 Increment: 0.01
 *RST: 0

Usage: Asynchronous command
Manual operation: See "[Y1 position, Y2 position](#)" on page 189

CURSor<cu>:TRACking[:STATe] <TrackCurve>

If enabled, the horizontal cursor lines tracks the waveform.

Suffix:
 <cu> 1...4, index of the cursor set

Parameters:
 <TrackCurve> ON | OFF
 *RST: ON

Usage: Asynchronous command
Manual operation: See "[Track waveform](#)" on page 189

CURSor<cu>:LABel <ShowLabel>

Shows the cursor labels in the diagram.

Suffix:
 <cu> 1...4, index of the cursor set

Parameters:
 <ShowLabel> ON | OFF
 *RST: OFF

Usage: Asynchronous command
Manual operation: See "[Show label](#)" on page 191

CURSor<cu>:SIAD <ShwInAllDiags>

Shows the enabled cursor measurements in all active diagrams of the same (time/spectrum) domain.

Suffix:
 <cu> 1...4, index of the cursor set

Parameters:
 <ShwInAllDiags> ON | OFF
 *RST: ON

Usage: Asynchronous command
Manual operation: See "[Show in all diagrams](#)" on page 190

CURSor<cu>:XCOupling <Coupling>

Defines the positioning mode of the vertical cursor.

Suffix:

<cu> 1...4, index of the cursor set

Parameters:

<Coupling> ON | OFF

ON

Moving one cursor line moves the other cursor line too. The cursor lines always remain a fixed distance.

OFF

Each cursor line is positioned independently.

*RST: OFF

Usage:

Asynchronous command

Manual operation: See "X, Y" on page 190

CURSor<cu>:YCOupling <Coupling>

Defines the positioning mode of the horizontal cursor. If the horizontal cursor lines track the waveform, the y-coupling is irrelevant (**CURSor<cu>:TRACking[:STATe]** is ON).

Suffix:

<cu> 1...4, index of the cursor set

Parameters:

<Coupling> ON | OFF

ON

Moving one cursor line moves the other cursor line too. The cursor lines always remain a fixed distance.

OFF

Each cursor line is positioned independently.

*RST: OFF

Usage:

Asynchronous command

Manual operation: See "X, Y" on page 190

CURSor<cu>:X1ENvelope <EnvelopeSelect>**CURSor<cu>:X2ENvelope <EnvelopeSelect>**

Define which horizontal cursor is positioned to the maximum and which to the minimum envelope values.

Prerequisites:

- **ACQUIRE:TYPE** on page 475 is set to **ENVELOpe**.
- **CURSor<cu>:TRACking[:STATe]** is set to **ON**.
- **CURSor<cu>:FUNCTion** is set to **PAIRed**.

Suffix:

<cu> 1...4, index of the cursor set

Parameters:

<EnvelopeSelect> MIN | MAX

MIN

The horizontal cursor is set to the crossing point of the vertical cursor with the minimum waveform envelope.

MAX

The horizontal cursor is set to the crossing point of the vertical cursor with the maximum waveform envelope.

*RST: MAX

Usage:

Asynchronous command

Manual operation: See "Envelope, Envelope 2" on page 189

17.13.2 Cursor results

CURSor<cu>:XDELta[:VALue]?	584
CURSor<cu>:XDELta:INVerse?	584
CURSor<cu>:YDELta[:VALue]?	585
CURSor<cu>:YDELta:SLOPe	585

CURSor<cu>:XDELta[:VALue]?

Queries the delta value (distance) of two vertical cursor lines.

Suffix:

<cu> 1...4, index of the cursor set

Return values:

<Delta> Range: -1E+26 to 1E+26
Increment: 0.1
*RST: 0
Default unit: s

Usage:

Query only
Asynchronous command

CURSor<cu>:XDELta:INVerse?

Queries the inverse value of the delta value (distance) of the two vertical cursor lines.

Suffix:

<cu> 1...4, index of the cursor set

Return values:

<DeltaInverse> Range: -1E+26 to 1E+26
Increment: 0.1
*RST: 0
Default unit: Hz

Usage: Query only
Asynchronous command

CURSor<cu>:YDELta[:VALue]?

Queries the delta value (distance) of the two horizontal cursor lines.

Suffix:
<cu> 1...4, index of the cursor set

Return values:
<Delta> Range: -1E+26 to 1E+26
Increment: 0
*RST: 0

Usage: Query only
Asynchronous command

CURSor<cu>:YDELta:SLOPe <DeltaSlope>

Returns the inverse value of the voltage difference - the reciprocal of the vertical distance of two horizontal cursor lines: $1/\Delta V$.

Suffix:
<cu> 1...4, index of the cursor set

Parameters:
<DeltaSlope> Range: -1E+26 to 1E+26
Increment: 0
*RST: 0

Usage: Asynchronous command

17.13.3 Peak search using cursors

CURSor<cu>:FFT:SETCenter.....	585
CURSor<cu>:FFT:TOCenter.....	586
CURSor<cu>:MAXimum[:PEAK].....	586
CURSor<cu>:MAXimum:LEFT.....	586
CURSor<cu>:MAXimum:RIGHT.....	586
CURSor<cu>:MAXimum:NEXT.....	587
CURSor<cu>:PEXCursion.....	587
CURSor<cu>:THReshold.....	587

CURSor<cu>:FFT:SETCenter

Sets the center frequency to the frequency value that is measured at cursor line Cu1.

Suffix:
<cu> 1...4, index of the cursor set

Usage: Setting only
Asynchronous command

Manual operation: See "[Set center frequency to](#)" on page 192

CURSor<cu>:FFT:TOCenter

Sets the vertical cursor line Cu1 to the center frequency.

Suffix:
<cu> 1...4, index of the cursor set

Usage: Setting only
Asynchronous command

Manual operation: See "[Center frequency](#)" on page 192

CURSor<cu>:MAXimum[:PEAK]

Sets both cursors to the absolute peak value.

Suffix:
<cu> 1...4, index of the cursor set

Usage: Event
Asynchronous command

Manual operation: See "[Absolute peak](#)" on page 191

CURSor<cu>:MAXimum:LEFT

Cursor 2 is set to the next peak to the left of the current position.

Suffix:
<cu> 1...4, index of the cursor set

Usage: Event
Asynchronous command

Manual operation: See "[Next peak left](#)" on page 192

CURSor<cu>:MAXimum:RIGHT

Cursor 2 is set to the next peak to the right of the current position.

Suffix:
<cu> 1...4, index of the cursor set

Usage: Event
Asynchronous command

Manual operation: See "[Next peak right](#)" on page 192

CURSor<cu>:MAXimum:NEXT

Cursor 2 is set to the next smaller absolute peak from the current position.

Suffix:

<cu> 1...4, index of the cursor set

Usage:

Event
Asynchronous command

Manual operation: See ["Next peak"](#) on page 192

CURSor<cu>:PEXCursion <Value>

Sets the minimum level by which the waveform must rise or fall so that it will be identified as a maximum or a minimum by the search functions.

Suffix:

<cu> 1...4, index of the cursor set

Parameters:

<Value>

Usage:

Asynchronous command

Manual operation: See ["Peak excursion"](#) on page 192

CURSor<cu>:THReshold <Value>

Sets an absolute threshold as an additional condition for the peak search. Only peaks that exceed the threshold are detected.

Suffix:

<cu> 1...4, index of the cursor set

Parameters:

<Value>

Usage:

Asynchronous command

Manual operation: See ["Threshold"](#) on page 192

17.13.4 Cursor appearance

CURSor<cu>:STYLe <Style>

Defines how the cursor is displayed in the diagram.

Suffix:

<cu> 1...4, index of the cursor set

Parameters:

<Style> LINES | LRHombus | VLRHombus | RHOMbus

LINes

The cursors are displayed as lines.

LRHombus

The cursors are displayed as lines. The intersections of the cursors with the waveforms are displayed by rhombus-shaped points.

VLRHombus

The cursors are displayed only as vertical lines. The intersections of the cursors with the waveforms are displayed by rhombus-shaped points.

RHOMbus

The intersections of the cursors with the waveforms are displayed by rhombus-shaped points.

*RST: LINes

Usage: Asynchronous command

Manual operation: See "Cursor style" on page 188

17.14 Spectrum analysis

17.14.1 Spectrum setup

| | |
|--|-----|
| CALCulate:SPECTrum<sp>:FREQUency:BANDwidth[:RESolution]:AUTO..... | 589 |
| CALCulate:SPECTrum<sp>:FREQUency:BANDwidth[:RESolution]:RATIo..... | 589 |
| CALCulate:SPECTrum<sp>:FREQUency:BANDwidth[:RESolution][:VALue]..... | 589 |
| CALCulate:SPECTrum<sp>:FREQUency:CENTer..... | 590 |
| CALCulate:SPECTrum<sp>:FREQUency:SCALE..... | 590 |
| CALCulate:SPECTrum<sp>:FREQUency:SPAN..... | 590 |
| CALCulate:SPECTrum<sp>:FREQUency:STARt..... | 591 |
| CALCulate:SPECTrum<sp>:FREQUency:STOP..... | 591 |
| CALCulate:SPECTrum<sp>:FREQUency:WINDow:TYPE..... | 591 |
| CALCulate:SPECTrum<sp>:MAGNitude:LEVel..... | 592 |
| CALCulate:SPECTrum<sp>:MAGNitude:RANGe..... | 592 |
| CALCulate:SPECTrum<sp>:MAGNitude:SCALE..... | 593 |
| CALCulate:SPECTrum<sp>:PRESet..... | 593 |
| CALCulate:SPECTrum<sp>:SOURce..... | 593 |
| CALCulate:SPECTrum<sp>:STATe..... | 594 |
| CALCulate:SPECTrum<sp>:THReshold..... | 594 |
| CALCulate:SPECTrum<sp>:PEXCursion..... | 594 |
| CALCulate:SPECTrum<sp>:WAVEform:AVERAge:COUNT..... | 595 |
| CALCulate:SPECTrum<sp>:WAVEform:AVERAge:ENABLE..... | 595 |
| CALCulate:SPECTrum<sp>:WAVEform:MAXimum:ENABLE..... | 595 |
| CALCulate:SPECTrum<sp>:WAVEform:MINimum:ENABLE..... | 595 |
| CALCulate:SPECTrum<sp>:WAVEform:NORMAl[:ENABLE]..... | 596 |

CALCulate:SPECTrum<sp>:FREQuency:BANDwidth[:RESolution]:AUTO
 <AutoRBW>

Couples the frequency span to the "RBW" setting.

Suffix:

<sp> 1...4, index of the spectrum

Parameters:

<AutoRBW> ON | OFF
 *RST: ON

Usage: Asynchronous command

Manual operation: See "Auto RBW" on page 223

CALCulate:SPECTrum<sp>:FREQuency:BANDwidth[:RESolution]:RATio
 <SpanRBWRatio>

Defines the coupling ratio for Span/RBW.

Available, if [CALCulate:SPECTrum<sp>:FREQuency:BANDwidth\[:RESolution\]:AUTO](#) is set to ON.

Suffix:

<sp> 1...4, index of the spectrum

Parameters:

<SpanRBWRatio> Range: 10 to 10000
 Increment: 1
 *RST: 1000

Usage: Asynchronous command

Manual operation: See "Span/RBW" on page 223

CALCulate:SPECTrum<sp>:FREQuency:BANDwidth[:RESolution][:VALue]
 <RBW>

Queries or defines the used resolution bandwidth.

Suffix:

<sp> 1...4, index of the spectrum

Parameters:

<RBW> Range: 0.0002 to 2000000
 Increment: 0.01
 *RST: 2000000
 Default unit: Hz

Usage: Asynchronous command

Manual operation: See "RBW" on page 223

CALCulate:SPECTrum<sp>:FREQUENCY:CENTer <Center>

Defines the position of the displayed frequency range, which is (Center - Span/2) to (Center + Span/2). The width of the range is defined using the frequency span setting.

Suffix:

<sp> 1...4, index of the spectrum

Parameters:

<Center> Range: -1E+26 to 1E+26
Increment: 0.01
*RST: 0

Usage: Asynchronous command

Manual operation: See "[Center](#)" on page 223

CALCulate:SPECTrum<sp>:FREQUENCY:SCALE <XAxisMode>

Defines the scaling method for the frequency axis (x-axis) of the spectrogram.

Suffix:

<sp> 1...4, index of the spectrum

Parameters:

<XAxisMode> LIN | LOG
LIN: linear scaling
LOG: logarithmic scaling
*RST: LIN

Usage: Asynchronous command

Manual operation: See "[Frequency axis](#)" on page 226

**CALCulate:SPECTrum<sp>:FREQUENCY:SPAN **

The span is specified in Hertz and defines the width of the displayed frequency range, which is (Center - Span/2) to (Center + Span/2). The position of the span is defined using the "Center" setting.

Suffix:

<sp> 1...4, index of the spectrum

Parameters:

 Range: 0 to 1E+26
Increment: 0.01
*RST: 0.01

Usage: Asynchronous command

Manual operation: See "[Span](#)" on page 223

CALCulate:SPECTrum<sp>:FREQUENCY:START <Start>

Defines the start frequency of the displayed frequency span.

Suffix:

<sp> 1...4, index of the spectrum

Parameters:

<Start> Range: -1E+26 to 1E+26
Increment: 0.01
*RST: 0.01

Usage: Asynchronous command

Manual operation: See "[Start](#)" on page 223

CALCulate:SPECTrum<sp>:FREQUENCY:STOP <Stop>

Sets the stop frequency of the displayed frequency span.

Suffix:

<sp> 1...4, index of the spectrum

Parameters:

<Stop> Range: -1E+26 to 1E+26
Increment: 0.01
*RST: 0.01

Usage: Asynchronous command

Manual operation: See "[Stop](#)" on page 223

CALCulate:SPECTrum<sp>:FREQUENCY:WINDOW:TYPE <WindowFunction>

Selects the window type. Windowing helps minimize the discontinuities at the end of the measured signal interval and thus reduces the effect of spectral leakage, increasing the frequency resolution.

Various different window functions are provided in the R&S MXO 5 to suit different input signals. Each of the window functions has specific characteristics, including some advantages and some trade-offs. Consider these characteristics carefully to find the optimum solution for the measurement task.

Suffix:

<sp> 1...4, index of the spectrum

Parameters:

<WindowFunction> RECTangular | HAMMING | HANN | BLACKharris | GAUSSian | FLATTOP2 | FLATtop2 | KAISerbessel

RECTangular

The rectangular window has the best frequency resolution, but a poor amplitude accuracy and is recommended for separating two tones with almost equal amplitudes and a small frequency distance.

HAMMING

The Hamming window is bell shaped and has a good frequency resolution and fair amplitude accuracy. It is recommended for frequency response measurements and sine waves, periodic signals and narrowband noise.

HANN

The Hann window is bell shaped and has a slightly worse frequency resolution but smaller sidelobe level than the Hamming window. The applications are the same.

BLACKHARRIS

The Blackman window is bell shaped and has a poor frequency resolution, but very good amplitude accuracy. It is recommended mainly for signals with single frequencies to detect harmonics.

GAUSSIAN

Good frequency resolution and best magnitude resolution, recommended for weak signals and short duration

FLATTOP2 = FLATTOP2

The flat top window has a poor frequency resolution, but the best amplitude accuracy and the sharpest sidelobe. It is recommended for accurate single tone amplitude measurements.

KAISERBESSEL

The kaiser-bessel window has a fair frequency resolution and good amplitude accuracy, and a very high sidelobe level. It is recommended for separating two tones with differing amplitudes and a small frequency distance.

*RST: BLACKHARRIS

Usage: Asynchronous command

Manual operation: See "[Window type](#)" on page 224

CALCulate:SPECTrum<sp>:MAGNitude:LEVel <VerticalMax>

Sets the maximum displayed value on the vertical scale.

Suffix:

<sp> 1...4, index of the spectrum

Parameters:

<VerticalMax> Range: -1E+26 to 10000000000000000
 Increment: 1
 *RST: 10

Usage: Asynchronous command

Manual operation: See "[Vertical maximum](#)" on page 226

CALCulate:SPECTrum<sp>:MAGNitude:RANGe <VerticalRange>

Sets the range of the spectrum values to be displayed.

Suffix:

<sp> 1...4, index of the spectrum

Parameters:

<VerticalRange> Range: 0 to 1000000000000000
 Increment: 0.01
 *RST: 100

Usage:

Asynchronous command

Manual operation: See "[Vertical range](#)" on page 226

CALCulate:SPECTrum<sp>:MAGNitude:SCALE <Unit>

Sets the unit for the y-axis.

Suffix:

<sp> 1...4, index of the spectrum

Parameters:

<Unit> LINear | DB | DBM | DBV | DBUV | DBS | DBHZ
 *RST: DBM

Usage:

Asynchronous command

Manual operation: See "[Magnitude unit](#)" on page 225

CALCulate:SPECTrum<sp>:PRESet

Presets the spectrum measurement.

Suffix:

<sp> 1...4, index of the spectrum

Usage:

Setting only
 Asynchronous command

Manual operation: See "[Spectrum preset](#)" on page 225

CALCulate:SPECTrum<sp>:SOURce <Source>

Selects the source for the spectrum.

Suffix:

<sp> 1...4, index of the spectrum

Parameters:

<Source> C1 | C2 | C3 | C4 | C5 | C6 | C7 | C8 | M1 | M2 | M3 | M4 | M5 |
 M6 | M7 | M8 | R1 | R2 | R3 | R4 | R5 | R6 | R7 | R8

Usage:

Asynchronous command

Manual operation: See "[Source](#)" on page 222

CALCulate:SPECTrum<sp>:STATe <State>

Enables the spectrum.

Suffix:

<sp> 1...4, index of the spectrum

Parameters:

<State> ON | OFF
*RST: OFF

Usage: Asynchronous command

Manual operation: See ["Display"](#) on page 222

CALCulate:SPECTrum<sp>:THReshold <Threshold>

Sets an absolute threshold as an additional condition for the peak search. Only peaks that exceed the threshold are detected.

Suffix:

<sp> 1...4, index of the spectrum

Parameters:

<Threshold> Range: -500 to 500
Increment: 1
*RST: -70
Default unit: dBm

Usage: Asynchronous command

Manual operation: See ["Threshold"](#) on page 192

CALCulate:SPECTrum<sp>:PEXCursion <PeakExcursion>

Defines a relative threshold, the minimum level value by which the waveform must rise by to be considered as a peak. For the peak to be considered, the excursion threshold must be met both on the left and the right sides of the peak.

To avoid identifying noise peaks, enter a peak excursion value that is higher than the noise levels.

Suffix:

<sp> 1...4, index of the spectrum

Parameters:

<PeakExcursion> Range: 0 to 100
Increment: 1
*RST: 5
Default unit: dB

Usage: Asynchronous command

Manual operation: See ["Peak excursion"](#) on page 192

CALCulate:SPECTrum<sp>:WAVEform:AVERAge:COUNT <AverageCount>

Sets the number of segments used for the averaging of the spectrum.

Suffix:

<sp> 1...4, index of the spectrum

Parameters:

<AverageCount> Range: 2 to 65534
Increment: 1
*RST: 1000

Usage: Asynchronous command

Manual operation: See "[Traces](#)" on page 224

CALCulate:SPECTrum<sp>:WAVEform:AVERAge:ENABLE <Enable>

Enables the average trace.

Suffix:

<sp> 1...4, index of the spectrum

Parameters:

<Enable> ON | OFF

Usage: Asynchronous command

Manual operation: See "[Traces](#)" on page 224

CALCulate:SPECTrum<sp>:WAVEform:MAXimum:ENABLE <Enable>

Enables the maximum trace.

Suffix:

<sp> 1...4, index of the spectrum

Parameters:

<Enable> ON | OFF

Usage: Asynchronous command

Manual operation: See "[Traces](#)" on page 224

CALCulate:SPECTrum<sp>:WAVEform:MINimum:ENABLE <Enable>

Enables the minimum trace.

Suffix:

<sp> 1...4, index of the spectrum

Parameters:

<Enable> ON | OFF

Usage: Asynchronous command

Manual operation: See ["Traces"](#) on page 224

CALCulate:SPECTrum<sp>:WAVEform:NORMAl[:ENABLE] <Enable>

Enables the normal spectrum trace.

Suffix:

<sp> 1...4, index of the spectrum

Parameters:

<Enable> ON | OFF

Usage:

Asynchronous command

Manual operation: See ["Traces"](#) on page 224

17.14.2 Spectrum gate

| | |
|--|-----|
| CALCulate:SPECTrum<sp>:GATE:POSition | 596 |
| CALCulate:SPECTrum<sp>:GATE:START | 596 |
| CALCulate:SPECTrum<sp>:GATE:STOP | 597 |
| CALCulate:SPECTrum<sp>:GATE:WIDTH | 597 |

CALCulate:SPECTrum<sp>:GATE:POSition <Center>

Sets the position of the displayed frequency range.

Suffix:

<sp> 1...4, index of the spectrum

Parameters:

<Center> Range: -1E+26 to 1E+26
Increment: 0.01
*RST: 0

Usage:

Asynchronous command

Manual operation: See ["Position"](#) on page 227

CALCulate:SPECTrum<sp>:GATE:START <Start>

Sets the starting value for the gate.

Suffix:

<sp> 1...4, index of the spectrum

Parameters:

<Start> Range: -1E+26 to 1E+26
Increment: 0.01
*RST: 0.01

Usage:

Asynchronous command

Manual operation: See ["Start"](#) on page 226

CALCulate:SPECTrum<sp>:GATE:STOP <Stop>

Sets the end value for the gate.

Suffix:

<sp> 1...4, index of the spectrum

Parameters:

<Stop> Range: -1E+26 to 1E+26
Increment: 0.01
*RST: 0.01

Usage: Asynchronous command

Manual operation: See "Stop" on page 227

**CALCulate:SPECTrum<sp>:GATE:WIDTH **

Defines the width of the displayed gate.

Suffix:

<sp> 1...4, index of the spectrum

Parameters:

 Range: 0 to 1E+26
Increment: 0.01
*RST: 0.01

Usage: Asynchronous command

Manual operation: See "Width" on page 227

17.14.3 Peak list

| | |
|--|-----|
| CALCulate:SPECTrum<sp>:PLISt:COUNT? | 597 |
| CALCulate:SPECTrum<sp>:PLISt[:STATe] | 598 |
| CALCulate:SPECTrum<sp>:PLISt:MAXCount | 598 |
| CALCulate:SPECTrum<sp>:PLISt:MODE | 598 |
| CALCulate:SPECTrum<sp>:PLISt:SOURce | 599 |
| CALCulate:SPECTrum<sp>:PLISt:SPOW | 599 |
| CALCulate:SPECTrum<sp>:PLISt:RESult[:VALue]? | 599 |
| CALCulate:SPECTrum<sp>:PLISt:SORT:COLumn | 599 |
| CALCulate:SPECTrum<sp>:PLISt:SORT:ORDER | 600 |
| CALCulate:SPECTrum<sp>:PLISt:LAbel:FREQUency[:STATe] | 600 |
| CALCulate:SPECTrum<sp>:PLISt:LAbel:MAXCount | 600 |
| CALCulate:SPECTrum<sp>:PLISt:LAbel:INVert | 601 |
| CALCulate:SPECTrum<sp>:PLISt:LAbel:MAXCount | 601 |
| CALCulate:SPECTrum<sp>:PLISt:LAbel[:STATe] | 601 |

CALCulate:SPECTrum<sp>:PLISt:COUNT?

Returns the current number of peak list results.

Suffix:
 <sp> 1...4, index of the spectrum

Return values:
 <Count>

Usage: Query only
 Asynchronous command

CALCulate:SPECTrum<sp>:PLISt[:STATe] <ShowTable>

Enables the display of the peak table.

Suffix:
 <sp> 1...4, index of the spectrum

Parameters:
 <ShowTable> ON | OFF
 *RST: OFF

Usage: Asynchronous command

Manual operation: See "[Peak table](#)" on page 228

CALCulate:SPECTrum<sp>:PLISt:MAXCount <MaxNoRes>

Sets the maximum number of measurement results that are listed in the result table.

Suffix:
 <sp> 1...4, index of the spectrum

Parameters:
 <MaxNoRes> Range: 1 to 1000
 Increment: 1
 *RST: 10

Usage: Asynchronous command

Manual operation: See "[Max results](#)" on page 230

CALCulate:SPECTrum<sp>:PLISt:MODE <ResultMode>

Selects how the measurement results are displayed.

Suffix:
 <sp> 1...4, index of the spectrum

Parameters:
 <ResultMode> ABS | REL
 *RST: ABS

Usage: Asynchronous command

Manual operation: See "[Result mode](#)" on page 230

CALCulate:SPECTrum<sp>:PLISt:SOURce <Source>

Selects the source of the peak table. You can select one of the traces that is enabled with [Traces](#).

Suffix:

<sp> 1...4, index of the spectrum

Parameters:

<Source> SPECMAXH1 | SPECMINH1 | SPECNORM1 | SPECAVER1

Usage:

Asynchronous command

Manual operation: See "[Source](#)" on page 230

CALCulate:SPECTrum<sp>:PLISt:SPOW <ShwPeaksOnWfm>

Displays a box with a description for each detected peak in the spectrum, including the magnitude.

If [CALCulate:SPECTrum<sp>:PLISt:LABel:FREQuency\[:STATE\]](#) is ON, the frequency values are also displayed.

Suffix:

<sp> 1...4, index of the spectrum

Parameters:

<ShwPeaksOnWfm> ON | OFF

*RST: OFF

Usage:

Asynchronous command

Manual operation: See "[Peak on waveform](#)" on page 228

CALCulate:SPECTrum<sp>:PLISt:RESult[:VALue]?

Returns the current peak list measurement results.

Suffix:

<sp> 1...4, index of the spectrum

Usage:

Query only
Asynchronous command

CALCulate:SPECTrum<sp>:PLISt:SORT:COLumn <ResultColumn>

Sorts the results in the spectrum peak list table either according to the frequency or according to the value.

Suffix:

<sp> 1...4, index of the spectrum

Parameters:

<ResultColumn> FREQ | VAL
 *RST: FREQ

Usage: Asynchronous command

CALCulate:SPECTrum<sp>:PLISt:SORT:ORDER <ResultOrder>

Defines if the spectrum peak list results are sorted in an ascending (increasing) or descending (decreasing) order.

Suffix:

<sp> 1...4, index of the spectrum

Parameters:

<ResultOrder> ASC | DESC
 ASC: ascending
 DESC: descending
 *RST: ASC

Usage: Asynchronous command

CALCulate:SPECTrum<sp>:PLISt:LABel:FREQUency[:STATE] <ShowFrequency>

Includes the frequency of the detected peak in the diagram labels.

Suffix:

<sp> 1...4, index of the spectrum

Parameters:

<ShowFrequency> ON | OFF
 *RST: ON

Usage: Asynchronous command

Manual operation: See "[Show frequency](#)" on page 230

CALCulate:SPECTrum<sp>:PLISt:LABel:MAXCount <MaxNumberPeaks>

Sets the maximum number of measurement results that are listed in the result table.

Suffix:

<sp> 1...4, index of the spectrum

Parameters:

<MaxNumberPeaks> Range: 1 to 100
 Increment: 1
 *RST: 10

Usage: Asynchronous command

CALCulate:SPECTrum<sp>:PLISt:LABel:INVert <Inverse>

Inverts the colors of the peak list labels, the peak boxes are shown with a white background.

Suffix:

<sp> 1...4, index of the spectrum

Parameters:

<Inverse> ON | OFF
*RST: OFF

Usage: Asynchronous command

CALCulate:SPECTrum<sp>:PLISt:LABel:MAXCount <MaxNumberPeaks>

Sets the maximum number of measurement results that are listed in the result table.

Suffix:

<sp> 1...4, index of the spectrum

Parameters:

<MaxNumberPeaks> Range: 1 to 100
Increment: 1
*RST: 10

Usage: Asynchronous command

CALCulate:SPECTrum<sp>:PLISt:LABel[:STATe] <ShowLabels>

Displays the labels in the peak list diagram.

Suffix:

<sp> 1...4, index of the spectrum

Parameters:

<ShowLabels> ON | OFF
*RST: ON

Usage: Asynchronous command

17.14.4 Data export of spectrum waveforms

For each of the spectrum traces, a dedicated command is available. For a description of the traces, see "[Traces](#)" on page 224.

CALCulate:SPECTrum<sp>:WAVEform:AVERage:DATA:HEADer?

CALCulate:SPECTrum<sp>:WAVEform:MAXimum:DATA:HEADer?

CALCulate:SPECTrum<sp>:WAVEform:MINimum:DATA:HEADer?

CALCulate:SPECTrum<sp>:WAVEform:NORMAL:DATA:HEADer?

Returns the header of spectrum data. The header contains attributes of the waveform.

Table 17-6: Header data

| Position | Meaning | Example |
|----------|--|--------------------------|
| 1 | XStart in s | -9.477E-008 = - 94,77 ns |
| 2 | XStop in s | 9.477E-008 = 94,77 ns |
| 3 | Record length of the waveform in Samples | 200000 |
| 4 | Always = 1 | 1 |

Suffix:

<sp> 1...4, index of the spectrum

Usage:

Query only
Asynchronous command

CALCulate:SPECtrum<sp>:WAVEform:AVERage:DATA[:VALues]? [<Offset>],
[<Length>]

CALCulate:SPECtrum<sp>:WAVEform:MAXimum:DATA[:VALues]? [<Offset>],
[<Length>]

CALCulate:SPECtrum<sp>:WAVEform:MINimum:DATA[:VALues]? [<Offset>],
[<Length>]

CALCulate:SPECtrum<sp>:WAVEform:NORMAL:DATA[:VALues]? [<Offset>],
[<Length>]

Returns the data of the spectrum points for transmission from the instrument to the controlling computer. The data can be used in MATLAB, for example.

Without parameters, the complete waveform is retrieved. Using the offset and length parameters, data can be retrieved in smaller portions, which makes the command faster. If you send only one parameter, it is interpreted as offset, and the data is retrieved from offset to the end of the waveform.

To set the export format, use [FORMat \[:DATA \]](#) on page 439.

Suffix:

<sp> 1...4, index of the spectrum

Query parameters:

<Offset> Number of offset waveform points to be skipped.
Range: 0 to m. Limit: n + m <= record length

<Length> Number of waveform points to be retrieved.
Range: 1 to n. Limit: n + m <= record length

Return values:

<Data> List of values according to the format and content settings.

Usage:

Query only
Asynchronous command

17.15 Applications

17.15.1 Frequency response analysis (option R&S MXO5-K36)

- Frequency response analysis settings..... 603
- Frequency response analysis amplitude profile..... 609
- Frequency response analysis calibration settings..... 610
- Frequency response analysis diagram settings..... 611
- Frequency response analysis results..... 615
- Frequency response analysis export..... 618

17.15.1.1 Frequency response analysis settings

| | |
|---|-----|
| FRANalysis:STATe..... | 603 |
| FRANalysis:ENABle..... | 604 |
| FRANalysis:AUToscale..... | 604 |
| FRANalysis:AMPLitude:MODE..... | 604 |
| FRANalysis:FREQuency:STARt..... | 604 |
| FRANalysis:FREQuency:STOP..... | 605 |
| FRANalysis:GENERator:AMPLitude..... | 605 |
| FRANalysis:GENERator:LOAD..... | 605 |
| FRANalysis:GENERator[:CHANnel]..... | 605 |
| FRANalysis:INPut[:SOURce]..... | 606 |
| FRANalysis:MEASurement:DELay:STATe..... | 606 |
| FRANalysis:MEASurement:DELay[:TIME]..... | 606 |
| FRANalysis:MEASurement:POINT[:DISPlay]..... | 606 |
| FRANalysis:MEASurement:RBW..... | 607 |
| FRANalysis:OUTPut[:SOURce]..... | 607 |
| FRANalysis:POINTs:LOGarithmic..... | 607 |
| FRANalysis:POINTs:MODE..... | 607 |
| FRANalysis:POINTs:TOTal..... | 608 |
| FRANalysis:REPeat..... | 608 |
| FRANalysis:RESet..... | 608 |
| FRANalysis:PHASe:MAXimum..... | 608 |

FRANalysis:STATe <Value>

Starts the frequency response analysis.

Parameters:

<Value> RUN | STOP

Usage: Asynchronous command

Manual operation: See "Run" on page 236

FRANalysis:ENABLE <State>

Enables the frequency response analysis application.

If the frequency response analysis is disabled, the instrument does not accept any `FRANalysis` command.

You can start the analysis with `FRANalysis:STATe`.

Parameters:

<State> ON | OFF

Usage: Asynchronous command

FRANalysis:AUToscale <AutoScale>

Enables the auto scaling function for each measurement.

Parameters:

<AutoScale> ON | OFF
*RST: ON

Usage: Asynchronous command

Manual operation: See "[Auto scale](#)" on page 240

FRANalysis:AMPLitude:MODE <AmplitudeMode>

Selects, if the amplitude is a constant value (`FRANalysis:GENerator:AMPLitude`) or is defined as an amplitude profile.

Parameters:

<AmplitudeMode> CONStant | PROFile
*RST: CONStant

Usage: Asynchronous command

Manual operation: See "[Amplitude profile](#)" on page 236

FRANalysis:FREQuency:START <StartFrequency>

Sets the start frequency of the sweep.

Parameters:

<StartFrequency> Range: 0.01 to 100000000
 Increment: 1
*RST: 100
 Default unit: Hz

Usage: Asynchronous command

Manual operation: See "[Start, Stop](#)" on page 235

FRANalysis:FREQuency:STOP <StopFrequency>

Sets the stop frequency of the sweep.

Parameters:

<StopFrequency> Range: 0.01 to 100000000
 Increment: 1
 *RST: 10000
 Default unit: Hz

Usage: Asynchronous command

Manual operation: See "[Start, Stop](#)" on page 235

FRANalysis:GENErator:AMPLitude <GenAmplitude>

Sets a fixed amplitude for the frequency response analysis.

Parameters:

<GenAmplitude> Range: 0.01 to 12
 Increment: 0.1
 *RST: 1
 Default unit: Vpp

Usage: Asynchronous command

Manual operation: See "[Amplitude](#)" on page 236

FRANalysis:GENErator:LOAD <GenLoad>

Selects the generator voltage display for 50Ω or high impedance load.

Parameters:

<GenLoad> FIFTy | HIZ
 HIZ: high input impedance
 *RST: FIFTy

Usage: Asynchronous command

Manual operation: See "[User load](#)" on page 236

FRANalysis:GENErator[:CHANnel] <GenCh>

Selects the built-in generator to start a frequency sweep for a defined frequency range.

Parameters:

<GenCh> GEN1 | GEN2
 *RST: GEN1

Usage: Asynchronous command

Manual operation: See "[Generator](#)" on page 235

FRANalysis:INPut[:SOURce] <InputChannel>

Sets the channel for the input signal of the DUT.

Parameters:

<InputChannel> C1 | C2 | C3 | C4 | C5 | C6 | C7 | C8
*RST: C1

Usage: Asynchronous command

Manual operation: See ["Input"](#) on page 235

FRANalysis:MEASurement:DELay:STATE <MeasDelay>

Enables the measurement delay. Set a measurement delay time with [FRANalysis:MEASurement:DELay\[:TIME\]](#).

Parameters:

<MeasDelay> ON | OFF
*RST: OFF

Usage: Asynchronous command

Manual operation: See ["Measurement delay, Delay time"](#) on page 239

FRANalysis:MEASurement:DELay[:TIME] <MeasDelayTime>

Sets a time delay, that the system waits before measuring the next point of the plot. This is helpful in systems that need more time to adapt to the new frequency, for example if filters with significant time group delays are present.

Available, if [FRANalysis:MEASurement:DELay:STATE](#) = ON.

Parameters:

<MeasDelayTime> Range: 0 to 10
Increment: 0.001
*RST: 0
Default unit: s

Usage: Asynchronous command

Manual operation: See ["Measurement delay, Delay time"](#) on page 239

FRANalysis:MEASurement:POINt[:DISPlay] <Points>

Enables the display of the measurement points for the frequency response analysis.

Parameters:

<Points> ON | OFF
*RST: ON

Usage: Asynchronous command

Manual operation: See ["Display points"](#) on page 240

FRANalysis:MEASurement:RBW <RBW>

Sets the resolution bandwidth, which determines the number of measurements that are used for creating the plot.

Parameters:

<RBW> HIGH | MID | LOW
*RST: MID

Usage: Asynchronous command

Manual operation: See "[RBW](#)" on page 239

FRANalysis:OUTPut[:SOURce] <OutputChannel>

Sets the channel for the output signal of the DUT.

Parameters:

<OutputChannel> C1 | C2 | C3 | C4 | C5 | C6 | C7 | C8
*RST: C2

Usage: Asynchronous command

Manual operation: See "[Output](#)" on page 235

FRANalysis:POINts:LOGarithmic <PtsPerDecade>

Selects the number of points that are measured per decade, if [FRANalysis:POINts:MODE](#) is set to `DECade`.

Parameters:

<PtsPerDecade> Range: 10 to 500
Increment: 1
*RST: 10

Usage: Asynchronous command

Manual operation: See "[Points](#)" on page 236

FRANalysis:POINts:MODE <PointsMode>

Selects, if the number of points for the FRA are measured as total or per decade.

You can set the number of points with [FRANalysis:POINts:TOTal](#)/[FRANalysis:POINts:LOGarithmic](#).

Parameters:

<PointsMode> TOTal | DECade
*RST: DECade

Usage: Asynchronous command

Manual operation: See "[Points](#)" on page 236

FRANalysis:POINTs:TOTal <TotalPoints>

Set the total number of points for the FRA analysis, if `FRANalysis:POINTs:MODE` on page 607 is set to `TOTal`.

Parameters:

<TotalPoints> Range: 10 to 5000
 Increment: 1
 *RST: 100

Usage: Asynchronous command

Manual operation: See "[Points](#)" on page 236

FRANalysis:REPeat <Repeat>

Repeats the measurement, using the same parameters.

Parameters:

<Repeat> ON | OFF
 *RST: OFF

Usage: Asynchronous command

Manual operation: See "[Repeat](#)" on page 236

FRANalysis:RESet

Resets the frequency response analysis.

Usage: Setting only
 Asynchronous command

FRANalysis:PHASe:MAXimum <MaxPhase>

Sets the upper boundary of the vertical phase window.

The lower boundary is given by "Maximum phase" - 360°.

By default, the "Maximum phase" is set to 180° for a phase window ranging from -180° to 180° accordingly.

Parameters:

<MaxPhase> Range: 0 to 360
 Increment: 1
 *RST: 180
 Default unit: °

Usage: Asynchronous command

Manual operation: See "[Maximum phase](#)" on page 239

17.15.1.2 Frequency response analysis amplitude profile

| | |
|--|-----|
| FRANalysis:AMPLitude:PROFile:COUNT..... | 609 |
| FRANalysis:AMPLitude:PROFile:APOint..... | 609 |
| FRANalysis:AMPLitude:PROFile:POINt<m>:REMOve..... | 609 |
| FRANalysis:AMPLitude:PROFile:SORT..... | 609 |
| FRANalysis:AMPLitude:PROFile:MODE..... | 610 |
| FRANalysis:AMPLitude:PROFile:POINt<m>:FREQuency..... | 610 |
| FRANalysis:AMPLitude:PROFile:POINt<m>:AMPLitude..... | 610 |

FRANalysis:AMPLitude:PROFile:COUNT <Value>

Returns the number of defined points for the amplitude profile.

Parameters:

<Value>

Usage: Asynchronous command

Manual operation: See "[Step start freq, Amplitude](#)" on page 237

FRANalysis:AMPLitude:PROFile:APOint

Adds a new point to the amplitude profile.

Usage: Setting only
Asynchronous command

Manual operation: See "[Add](#)" on page 237

FRANalysis:AMPLitude:PROFile:POINt<m>:REMOve

Removes the selected amplitude point from the list.

Suffix:
<m> Index of the amplitude profile point

Usage: Setting only
Asynchronous command

Manual operation: See "[Delete](#)" on page 238

FRANalysis:AMPLitude:PROFile:SORT

Sorts the points in the amplitude table by frequency, starting with the lowest frequency.

Usage: Setting only
Asynchronous command

Manual operation: See "[Sort](#)" on page 238

FRANalysis:AMPLitude:PROFile:MODE <VoltageChange>

Selects if the voltage change is done as a single step or as a ramp.

Parameters:

<VoltageChange> SINGle | RAMP
 *RST: SINGle

Usage: Asynchronous command

Manual operation: See "[Voltage change](#)" on page 237

FRANalysis:AMPLitude:PROFile:POINT<m>:FREQUENCY <Frequency>

Sets the start frequency for the selected point.

Suffix:

<m> Index of the amplitude profile point

Parameters:

<Frequency> Range: 0.01 to 100E6
 Increment: 1
 *RST: 100
 Default unit: Hz

Usage: Asynchronous command

Manual operation: See "[Step start freq, Amplitude](#)" on page 237

FRANalysis:AMPLitude:PROFile:POINT<m>:AMPLitude <Amplitude>

Sets the amplitude for the selected point.

Suffix:

<m> Index of the amplitude profile point

Parameters:

<Amplitude> Range: 0 to 5.995
 Increment: 0.1
 *RST: 1
 Default unit: Vpp

Usage: Asynchronous command

Manual operation: See "[Step start freq, Amplitude](#)" on page 237

17.15.1.3 Frequency response analysis calibration settings

| | |
|--|-----|
| FRANalysis:CALibration:CALibration | 611 |
| FRANalysis:CALibration:RESult? | 611 |
| FRANalysis:CALibration:STATe | 611 |

FRANalysis:CALibration:CALibration

Runs a calibration sequence.

Usage: Event

Manual operation: See "[Start calibration](#)" on page 244

FRANalysis:CALibration:RESult?

Returns the result of the calibration.

Return values:

<States> PASS | FAIL | RUN | NOAL
PASS: the calibration is successful.
FAIL: the calibration failed.
RUN: a calibration cycle is running.
NOAL: no active calibration.
*RST: NOAL

Usage: Query only

Manual operation: See "[Start calibration](#)" on page 244

FRANalysis:CALibration:STATe <UseCalibrationDat>

Sets the state of calibration.

Parameters:

<UseCalibrationDat> ON | OFF
*RST: OFF

Manual operation: See "[Use calibration data](#)" on page 244

17.15.1.4 Frequency response analysis diagram settings

| | |
|---|-----|
| FRANalysis:PHASe:ENABLE | 612 |
| FRANalysis:PHASe:OFFSet | 612 |
| FRANalysis:PHASe:SCALe | 612 |
| FRANalysis:GAIN:ENABLE | 612 |
| FRANalysis:GAIN:OFFSet | 612 |
| FRANalysis:GAIN:SCALe | 613 |
| FRANalysis:AMPLitude:SCALe | 613 |
| FRANalysis:AMPLitude:ENABLE | 613 |
| FRANalysis:AMPLitude:OFFSet | 613 |
| FRANalysis:PHASe:DATA? | 614 |
| FRANalysis:FREQuency:DATA? | 614 |
| FRANalysis:GAIN:DATA? | 614 |

FRANalysis:PHASe:ENABLE <State>

Enables the phase waveform for the frequency response analysis.

Parameters:

<State> ON | OFF
*RST: OFF

Usage: Asynchronous command

FRANalysis:PHASe:OFFSet <VerticalOffset>

Sets a vertical offset of the phase waveform.

Parameters:

<VerticalOffset> Range: -10000 to 10000
Increment: 1
*RST: 0
Default unit: °

Usage: Asynchronous command

FRANalysis:PHASe:SCALE <VerticalScale>

Sets the vertical scale for the phase waveform.

Parameters:

<VerticalScale> Range: 1 to 180
Increment: 1
*RST: 36
Default unit: °/div

Usage: Asynchronous command

FRANalysis:GAIN:ENABLE <State>

Enables the gain waveform for the frequency response analysis.

Parameters:

<State> ON | OFF
*RST: OFF

Usage: Asynchronous command

FRANalysis:GAIN:OFFSet <VerticalOffset>

Sets a vertical offset of the gain waveform.

Parameters:

<VerticalOffset> Range: -2000 to 2000
 Increment: 1
 *RST: 10
 Default unit: dB

Usage: Asynchronous command

FRANalysis:GAIN:SCALE <VerticalScale>

Sets the vertical scale for the gain waveform.

Parameters:

<VerticalScale> Range: 0.1 to 20
 Increment: 1
 *RST: 10
 Default unit: dB/div

Usage: Asynchronous command

FRANalysis:AMPLitude:SCALE <VerticalScale>

Sets the vertical scale for the amplitude waveform.

Parameters:

<VerticalScale> Range: 0.01 to 10
 Increment: 0.01
 *RST: 0.5
 Default unit: Vpp/div

Usage: Asynchronous command

FRANalysis:AMPLitude:ENABLE <State>

Enables the amplitude signal for the frequency response analysis. You can then define the amplitude profile of the signal.

Parameters:

<State> ON | OFF
 *RST: OFF

Usage: Asynchronous command

Manual operation: See "[Amplitude profile](#)" on page 236

FRANalysis:AMPLitude:OFFSet <VerticalOffset>

Sets a vertical offset of the amplitude waveform.

Parameters:

<VerticalOffset> Range: -100 to 100
 Increment: 0.01
 *RST: 5
 Default unit: Vpp

Usage: Asynchronous command

FRANalysis:PHASe:DATA?

Returns the data of the phase as a list of comma-separated values in degree.

Example: FRAN:PHAS:DATA?
 Result:
 -0.07463742650985239,-0.09417628145200041,
 -0.1457021392091207,-0.1914790795969807,
 -0.2494368612845221,-0.3415108478964939,
 -0.4350150706042513,-0.5673151547214843,
 -0.7363486980048108,-0.9055923620805615,
 -1.0829557075417

Usage: Query only
 Asynchronous command

FRANalysis:FREQuency:DATA?

Returns the data of the frequency points for which gain and phase has been calculated as a list of comma-separated values in Hz.

Example: FRAN:FREQ:DATA?
 Result:
 -0.07463742650985239,-0.09417628145200041,
 -0.1457021392091207,-0.1914790795969807,
 -0.2494368612845221,-0.3415108478964939,
 -0.4350150706042513,-0.5673151547214843,
 -0.7363486980048108,-0.9055923620805615,
 -1.0829557075417

Usage: Query only
 Asynchronous command

FRANalysis:GAIN:DATA?

Returns the data of the gain as a list of comma-separated values in dB.

Example: FRAN:GAIN:DATA?
Result:
 0.4381956630254851,0.4593246383252179,
 0.461895233375762,0.4570717993766185,
 0.4623802509651942,0.4533450898899926,
 0.4408194360143725,0.4221600784741697,
 0.4483342212879299,0.4473558449908476,
 0.4915016244058707

Usage: Query only
 Asynchronous command

17.15.1.5 Frequency response analysis results

| | |
|---|-----|
| FRANalysis:RESult:STATe..... | 615 |
| FRANalysis:MARGin:STATe..... | 615 |
| FRANalysis:MARGin:GAIN:FREQuency?..... | 616 |
| FRANalysis:MARGin:GAIN:VALue?..... | 616 |
| FRANalysis:MARGin:PHASe:FREQuency?..... | 616 |
| FRANalysis:MARGin:PHASe:VALue?..... | 616 |
| FRANalysis:MARKer<m>:STATe..... | 616 |
| FRANalysis:MARKer<m>:FREQuency..... | 617 |
| FRANalysis:MARKer<m>:GAIN?..... | 617 |
| FRANalysis:MARKer<m>:PHASe?..... | 617 |
| FRANalysis:MARKer<m>:SSCReen..... | 617 |

FRANalysis:RESult:STATe <Table>

Enables the display of the result table for the FRA.

Parameters:

<Table> ON | OFF
 *RST: ON

Usage: Asynchronous command

Manual operation: See "[Result table](#)" on page 240

FRANalysis:MARGin:STATe <Margins>

Enables the display of the margin table for the FRA.

Parameters:

<Margins> ON | OFF
 *RST: ON

Usage: Asynchronous command

Manual operation: See "[Margin](#)" on page 240

FRANalysis:MARGin:GAIN:FREQuency?

Returns the frequency of the gain margin.

Return values:

<Frequency>

Usage: Query only
Asynchronous command

FRANalysis:MARGin:GAIN:VALue?

Returns the value of the gain margin.

Return values:

<Phase>

Usage: Query only
Asynchronous command

FRANalysis:MARGin:PHASe:FREQuency?

Returns the frequency of the phase margin.

Return values:

<Frequency>

Usage: Query only
Asynchronous command

FRANalysis:MARGin:PHASe:VALue?

Returns the value of the phase margin.

Return values:

<Phase>

Usage: Query only
Asynchronous command

FRANalysis:MARKer<m>:STATe <Markers>

Enables the display of the marker table for the FRA.

Suffix:

<m> Irrelevant, omit the suffix.

Parameters:

<Markers> ON | OFF
*RST: ON

Usage: Asynchronous command

Manual operation: See "[Markers](#)" on page 240

FRANalysis:MARKer<m>:FREQUency <Frequency>

Returns the frequency for the specified marker.

Suffix:

<m> 1..2
Selects the marker number.

Parameters:

<Frequency> Range: 0.01 to 1000000000
Increment: 1E-05
*RST: 1000
Default unit: Hz

Usage: Asynchronous command

FRANalysis:MARKer<m>:GAIN?

Returns the gain for the specified marker.

Suffix:

<m> 1..2
Selects the marker number.

Usage: Query only
Asynchronous command

FRANalysis:MARKer<m>:PHASe?

Returns the phase value for the specified marker.

Suffix:

<m> 1..2
Selects the marker number.

Usage: Query only
Asynchronous command

FRANalysis:MARKer<m>:SSCReen

Resets the marker to their initial positions. Reset is helpful if the markers have disappeared from the display or need to be moved for a larger distance.

Suffix:

<m> 1..2
Selects the marker number.

Usage: Setting only
Asynchronous command

17.15.1.6 Frequency response analysis export

| | |
|--------------------------------------|-----|
| EXPort:RESult:SElect:FRA:MARGin..... | 618 |
| EXPort:RESult:SElect:FRA:MARKer..... | 618 |
| EXPort:RESult:SElect:FRA:RESult..... | 618 |

EXPort:RESult:SElect:FRA:MARGin <MarginResult>

If enabled, includes the margin results in the results export file of the FRA.

Parameters:

<MarginResult> ON | OFF
 *RST: OFF

Usage: Asynchronous command

Manual operation: See "[FRA results](#)" on page 245

EXPort:RESult:SElect:FRA:MARKer <MarkerResult>

If enabled, includes the marker results in the results export file of the FRA.

Parameters:

<MarkerResult> ON | OFF
 *RST: OFF

Usage: Asynchronous command

Manual operation: See "[FRA results](#)" on page 245

EXPort:RESult:SElect:FRA:RESult <Result>

If enabled, includes the frequency response analysis results, including the frequency, gain, phase and amplitude, in the results export file of the FRA.

Parameters:

<Result> ON | OFF
 *RST: OFF

Usage: Asynchronous command

Manual operation: See "[FRA results](#)" on page 245

17.15.2 Power analysis (option R&S MXO5-K31)

Some of the commands in the following chapter are asynchronous. An overlapping or asynchronous command does not automatically finish executing before the next command starts executing. If overlapping commands must be executed in a defined order, e.g. to avoid wrong measurement results, they must be serviced sequentially.

To prevent an overlapping execution of commands, one of the commands *OPC, *OPC? or *WAI can be used after the command or a command set.

For more information, see:

- www.rohde-schwarz.com/rc-via-scp, chapter "Command sequence and synchronization"

Overview of statistic commands

The remote commands for the power analysis measurements can include statistic results. In the following the abbreviations after the commands have the following meaning:

| Command | Description |
|-----------------------------------|--|
| POWer<m>:xxx:RESult:nnn[:ACTual]? | Current measurement result |
| POWer<m>:xxx:RESult:nnn:AVERage? | Average of the measurement results |
| POWer<m>:xxx:RESult:nnn:RMS? | RMS value of the measurement results |
| POWer<m>:xxx:RESult:nnn:PPEak? | Positive peak value of the measurement results |
| POWer<m>:xxx:RESult:nnn:NPEak? | Negative peak value of the measurement results |
| POWer<m>:xxx:RESult:xxx:STDDev? | Standard deviation of the measurement results |

- [General settings](#)..... 619
- [Power quality](#)..... 620
- [Power harmonics](#)..... 628
- [Reference level](#)..... 635
- [Power analysis data](#)..... 639

17.15.2.1 General settings

| | |
|---|-----|
| POWer<m>[:ENABLE] | 619 |
| POWer<m>:TYPE | 619 |
| POWer<m>:ASKew[:EXECute] | 620 |
| EXPort:RESult:SElect:POWer<m> | 620 |

POWer<m>[:ENABLE] <State>

Enables the power measurement instance.

Suffix:

<m> 1...6, index of the power analysis measurement

Parameters:

<State> ON | OFF

Usage: Asynchronous command

Manual operation: See "[Add](#)" on page 248

POWer<m>:TYPE <Type>

Sets the type for the respective power analysis measurement.

| | |
|--------------------------|---|
| Suffix: | |
| <m> | 1...6, index of the power analysis measurement |
| Parameters: | |
| <Type> | QUALity HARMonics |
| Example: | POW1:TYPE QUAL
Sets the 1st power analysis measurement to quality. |
| Usage: | Asynchronous command |
| Manual operation: | See "Add" on page 248 |

POWER<m>:ASKew[:EXECute]

Performs auto deskew adjustment.

| | |
|--------------------------|---|
| Suffix: | |
| <m> | Irrelevant, omit the suffix. |
| Usage: | Event
Asynchronous command |
| Manual operation: | See "Auto Deskew" on page 262 |

EXPort:RESult:SElect:POWER<m> <ExportResults>

If enabled, includes the results of selected power analysis measurement in the results export file.

| | |
|--------------------|--|
| Suffix: | |
| <m> | 1...6, index of the power analysis measurement |
| Parameters: | |
| <ExportResults> | ON OFF
*RST: OFF |
| Usage: | Asynchronous command |

17.15.2.2 Power quality**Power quality setup**

| | |
|--|-----|
| POWER<m>:QUALity:SOURce:CURRent | 620 |
| POWER<m>:QUALity:SOURce[:VOLTage] | 621 |
| POWER<m>:QUALity:FREQUENCY[:VALue] | 621 |
| POWER<m>:QUALity:FREQUENCY:USER | 621 |

POWER<m>:QUALity:SOURce:CURRent <CurrentSource>

Sets the channel for the current source input of the power quality analysis.

Suffix:
 <m> 1...6, index of the power analysis measurement

Parameters:
 <CurrentSource> C1 | C2 | C3 | C4 | C5 | C6 | C7 | C8

Usage: Asynchronous command

Manual operation: See "[Current](#)" on page 252

POWER<m>:QUALity:SOURce[:VOLTage] <VoltageSource>

Sets the channel for the voltage source input of the power quality analysis.

Suffix:
 <m> 1...6, index of the power analysis measurement

Parameters:
 <VoltageSource> C1 | C2 | C3 | C4 | C5 | C6 | C7 | C8

Usage: Asynchronous command

Manual operation: See "[Voltage](#)" on page 251

POWER<m>:QUALity:FREQuency[:VALue] <FundamentalFreq>

Sets the input frequency of the source signal in Hz.

Suffix:
 <m> 1...6, index of the power analysis measurement

Parameters:
 <FundamentalFreq> F50 | F60 | F400 | USER | AUTO
 *RST: F50

Usage: Asynchronous command

Manual operation: See "[Fund. Freq](#)" on page 252

POWER<m>:QUALity:FREQuency:USER <FundamentalFreq>

Sets the user-defined frequency, if [POWER<m>:QUALity:FREQuency\[:VALue\]](#) on page 621 is set to USER.

Suffix:
 <m> 1...6, index of the power analysis measurement

Parameters:
 <FundamentalFreq> Range: 10 to 1000000
 Increment: 1
 *RST: 50
 Default unit: Hz

Usage: Asynchronous command

Manual operation: See "[Fund. Freq](#)" on page 252

Power quality results

| | |
|---|-----|
| POWER<m>:QUALity:RESult:CURRent:CREStfactor[:ACTual]? | 623 |
| POWER<m>:QUALity:RESult:CURRent:CREStfactor:AVERAge? | 623 |
| POWER<m>:QUALity:RESult:CURRent:CREStfactor:NPEak? | 623 |
| POWER<m>:QUALity:RESult:CURRent:CREStfactor:PPEak? | 623 |
| POWER<m>:QUALity:RESult:CURRent:CREStfactor:RMS? | 623 |
| POWER<m>:QUALity:RESult:CURRent:CREStfactor:STDDev? | 623 |
| POWER<m>:QUALity:RESult:CURRent:PEAK[:ACTual]? | 623 |
| POWER<m>:QUALity:RESult:CURRent:PEAK:AVERAge? | 623 |
| POWER<m>:QUALity:RESult:CURRent:PEAK:NPEak? | 623 |
| POWER<m>:QUALity:RESult:CURRent:PEAK:PPEak? | 624 |
| POWER<m>:QUALity:RESult:CURRent:PEAK:RMS? | 624 |
| POWER<m>:QUALity:RESult:CURRent:PEAK:STDDev? | 624 |
| POWER<m>:QUALity:RESult:CURRent:RMS[:ACTual]? | 624 |
| POWER<m>:QUALity:RESult:CURRent:RMS:AVERAge? | 624 |
| POWER<m>:QUALity:RESult:CURRent:RMS:NPEak? | 624 |
| POWER<m>:QUALity:RESult:CURRent:RMS:PPEak? | 624 |
| POWER<m>:QUALity:RESult:CURRent:RMS:RMS? | 624 |
| POWER<m>:QUALity:RESult:CURRent:RMS:STDDev? | 624 |
| POWER<m>:QUALity:RESult:POWer:APParent[:ACTual]? | 624 |
| POWER<m>:QUALity:RESult:POWer:APParent:AVERAge? | 624 |
| POWER<m>:QUALity:RESult:POWer:APParent:NPEak? | 624 |
| POWER<m>:QUALity:RESult:POWer:APParent:PPEak? | 624 |
| POWER<m>:QUALity:RESult:POWer:APParent:RMS? | 624 |
| POWER<m>:QUALity:RESult:POWer:APParent:STDDev? | 624 |
| POWER<m>:QUALity:RESult:POWer:PFACtor[:ACTual]? | 625 |
| POWER<m>:QUALity:RESult:POWer:PFACtor:AVERAge? | 625 |
| POWER<m>:QUALity:RESult:POWer:PFACtor:NPEak? | 625 |
| POWER<m>:QUALity:RESult:POWer:PFACtor:PPEak? | 625 |
| POWER<m>:QUALity:RESult:POWer:PFACtor:RMS? | 625 |
| POWER<m>:QUALity:RESult:POWer:PFACtor:STDDev? | 625 |
| POWER<m>:QUALity:RESult:POWer:PHASe[:ACTual]? | 625 |
| POWER<m>:QUALity:RESult:POWer:PHASe:AVERAge? | 625 |
| POWER<m>:QUALity:RESult:POWer:PHASe:NPEak? | 625 |
| POWER<m>:QUALity:RESult:POWer:PHASe:PPEak? | 625 |
| POWER<m>:QUALity:RESult:POWer:PHASe:RMS? | 625 |
| POWER<m>:QUALity:RESult:POWer:PHASe:STDDev? | 625 |
| POWER<m>:QUALity:RESult:POWer:REACTive[:ACTual]? | 626 |
| POWER<m>:QUALity:RESult:POWer:REACTive:AVERAge? | 626 |
| POWER<m>:QUALity:RESult:POWer:REACTive:NPEak? | 626 |
| POWER<m>:QUALity:RESult:POWer:REACTive:PPEak? | 626 |
| POWER<m>:QUALity:RESult:POWer:REACTive:RMS? | 626 |
| POWER<m>:QUALity:RESult:POWer:REACTive:STDDev? | 626 |
| POWER<m>:QUALity:RESult:POWer:REALpower[:ACTual]? | 626 |
| POWER<m>:QUALity:RESult:POWer:REALpower:AVERAge? | 626 |
| POWER<m>:QUALity:RESult:POWer:REALpower:NPEak? | 626 |
| POWER<m>:QUALity:RESult:POWer:REALpower:PPEak? | 626 |
| POWER<m>:QUALity:RESult:POWer:REALpower:RMS? | 626 |
| POWER<m>:QUALity:RESult:POWer:REALpower:STDDev? | 626 |

| | |
|---|-----|
| POWer<m>:QUALity:RESult:VOLTagE:CREStfactor[:ACTual]? | 626 |
| POWer<m>:QUALity:RESult:VOLTagE:CREStfactor:AVERAge? | 626 |
| POWer<m>:QUALity:RESult:VOLTagE:CREStfactor:NPEak? | 626 |
| POWer<m>:QUALity:RESult:VOLTagE:CREStfactor:PPEak? | 626 |
| POWer<m>:QUALity:RESult:VOLTagE:CREStfactor:RMS? | 626 |
| POWer<m>:QUALity:RESult:VOLTagE:CREStfactor:STDDev? | 626 |
| POWer<m>:QUALity:RESult:VOLTagE:FREQuency[:ACTual]? | 627 |
| POWer<m>:QUALity:RESult:VOLTagE:FREQuency:AVERAge? | 627 |
| POWer<m>:QUALity:RESult:VOLTagE:FREQuency:NPEak? | 627 |
| POWer<m>:QUALity:RESult:VOLTagE:FREQuency:PPEak? | 627 |
| POWer<m>:QUALity:RESult:VOLTagE:FREQuency:RMS? | 627 |
| POWer<m>:QUALity:RESult:VOLTagE:FREQuency:STDDev? | 627 |
| POWer<m>:QUALity:RESult:VOLTagE:PEAK[:ACTual]? | 627 |
| POWer<m>:QUALity:RESult:VOLTagE:PEAK:AVERAge? | 627 |
| POWer<m>:QUALity:RESult:VOLTagE:PEAK:NPEak? | 627 |
| POWer<m>:QUALity:RESult:VOLTagE:PEAK:PPEak? | 627 |
| POWer<m>:QUALity:RESult:VOLTagE:PEAK:RMS? | 627 |
| POWer<m>:QUALity:RESult:VOLTagE:PEAK:STDDev? | 627 |
| POWer<m>:QUALity:RESult:VOLTagE:RMS[:ACTual]? | 628 |
| POWer<m>:QUALity:RESult:VOLTagE:RMS:AVERAge? | 628 |
| POWer<m>:QUALity:RESult:VOLTagE:RMS:NPEak? | 628 |
| POWer<m>:QUALity:RESult:VOLTagE:RMS:PPEak? | 628 |
| POWer<m>:QUALity:RESult:VOLTagE:RMS:RMS? | 628 |
| POWer<m>:QUALity:RESult:VOLTagE:RMS:STDDev? | 628 |

POWer<m>:QUALity:RESult:CURRent:CREStfactor[:ACTual]?
POWer<m>:QUALity:RESult:CURRent:CREStfactor:AVERAge?
POWer<m>:QUALity:RESult:CURRent:CREStfactor:NPEak?
POWer<m>:QUALity:RESult:CURRent:CREStfactor:PPEak?
POWer<m>:QUALity:RESult:CURRent:CREStfactor:RMS?
POWer<m>:QUALity:RESult:CURRent:CREStfactor:STDDev?

Returns the current crest factor, the *Peak value / RMS value* value for the power quality analysis.

For details on the statistics, see "[Overview of statistic commands](#)" on page 619.

Suffix:

<m> 1...6, index of the power analysis measurement

Return values:

<StdDev> Range: -1E+26 to 1E+26
Increment: 1E-10
*RST: 0

Usage:

Query only
Asynchronous command

POWer<m>:QUALity:RESult:CURRent:PEAK[:ACTual]?
POWer<m>:QUALity:RESult:CURRent:PEAK:AVERAge?
POWer<m>:QUALity:RESult:CURRent:PEAK:NPEak?

POWer<m>:QUALity:RESult:CURRent:PEAK:PPEak?
POWer<m>:QUALity:RESult:CURRent:PEAK:RMS?
POWer<m>:QUALity:RESult:CURRent:PEAK:STDDev?

Returns the current peak value, the highest measured magnitude value for the power quality analysis.

For details on the statistics, see "[Overview of statistic commands](#)" on page 619.

Suffix:

<m> 1...6, index of the power analysis measurement

Return values:

<StdDev> Range: -1E+26 to 1E+26
 Increment: 1E-10
 *RST: 0

Usage:

Query only
 Asynchronous command

POWer<m>:QUALity:RESult:CURRent:RMS[:ACTual]?
POWer<m>:QUALity:RESult:CURRent:RMS:AVERAge?
POWer<m>:QUALity:RESult:CURRent:RMS:NPEak?
POWer<m>:QUALity:RESult:CURRent:RMS:PPEak?
POWer<m>:QUALity:RESult:CURRent:RMS:RMS?
POWer<m>:QUALity:RESult:CURRent:RMS:STDDev?

Returns the root mean square of the current for the power quality analysis.

For details on the statistics, see "[Overview of statistic commands](#)" on page 619.

Suffix:

<m> 1...6, index of the power analysis measurement

Return values:

<StdDev> Range: -1E+26 to 1E+26
 Increment: 1E-10
 *RST: 0

Usage:

Query only
 Asynchronous command

POWer<m>:QUALity:RESult:POWer:APParent[:ACTual]?
POWer<m>:QUALity:RESult:POWer:APParent:AVERAge?
POWer<m>:QUALity:RESult:POWer:APParent:NPEak?
POWer<m>:QUALity:RESult:POWer:APParent:PPEak?
POWer<m>:QUALity:RESult:POWer:APParent:RMS?
POWer<m>:QUALity:RESult:POWer:APParent:STDDev?

Returns the apparent power for the power quality analysis.

For details on the statistics, see "[Overview of statistic commands](#)" on page 619.

Suffix:

<m> 1...6, index of the power analysis measurement

Return values:

<StdDev> Range: -1E+26 to 1E+26
 Increment: 1E-10
 *RST: 0

Usage:

Query only
 Asynchronous command

POWER<m>:QUALity:RESult:POWER:PFACtor[:ACTual]?
POWER<m>:QUALity:RESult:POWER:PFACtor:AVERAge?
POWER<m>:QUALity:RESult:POWER:PFACtor:NPEak?
POWER<m>:QUALity:RESult:POWER:PFACtor:PPEak?
POWER<m>:QUALity:RESult:POWER:PFACtor:RMS?
POWER<m>:QUALity:RESult:POWER:PFACtor:STDDev?

Returns the power factor for the power quality analysis.

For details on the statistics, see "[Overview of statistic commands](#)" on page 619.

Suffix:

<m> 1...6, index of the power analysis measurement

Return values:

<StdDev> Range: -1E+26 to 1E+26
 Increment: 1E-10
 *RST: 0

Usage:

Query only
 Asynchronous command

POWER<m>:QUALity:RESult:POWER:PHASe[:ACTual]?
POWER<m>:QUALity:RESult:POWER:PHASe:AVERAge?
POWER<m>:QUALity:RESult:POWER:PHASe:NPEak?
POWER<m>:QUALity:RESult:POWER:PHASe:PPEak?
POWER<m>:QUALity:RESult:POWER:PHASe:RMS?
POWER<m>:QUALity:RESult:POWER:PHASe:STDDev?

Returns the phase for the power quality analysis.

For details on the statistics, see "[Overview of statistic commands](#)" on page 619.

Suffix:

<m> 1...6, index of the power analysis measurement

Return values:

<StdDev> Range: -1E+26 to 1E+26
 Increment: 1E-10
 *RST: 0

Usage:

Query only
 Asynchronous command

POWer<m>:QUALity:RESult:POWer:REACTive[:ACTual]?
POWer<m>:QUALity:RESult:POWer:REACTive:AVERAge?
POWer<m>:QUALity:RESult:POWer:REACTive:NPEak?
POWer<m>:QUALity:RESult:POWer:REACTive:PPEak?
POWer<m>:QUALity:RESult:POWer:REACTive:RMS?
POWer<m>:QUALity:RESult:POWer:REACTive:STDDev?

Returns the reactive power for the power quality analysis.

For details on the statistics, see "[Overview of statistic commands](#)" on page 619.

Suffix:

<m> 1...6, index of the power analysis measurement

Return values:

<StdDev> Range: -1E+26 to 1E+26
 Increment: 1E-10
 *RST: 0

Usage:

Query only
 Asynchronous command

POWer<m>:QUALity:RESult:POWer:REALpower[:ACTual]?
POWer<m>:QUALity:RESult:POWer:REALpower:AVERAge?
POWer<m>:QUALity:RESult:POWer:REALpower:NPEak?
POWer<m>:QUALity:RESult:POWer:REALpower:PPEak?
POWer<m>:QUALity:RESult:POWer:REALpower:RMS?
POWer<m>:QUALity:RESult:POWer:REALpower:STDDev?

Returns the active power for the power quality analysis.

For details on the statistics, see "[Overview of statistic commands](#)" on page 619.

Suffix:

<m> 1...6, index of the power analysis measurement

Return values:

<StdDev> Range: -1E+26 to 1E+26
 Increment: 1E-10
 *RST: 0

Usage:

Query only
 Asynchronous command

POWer<m>:QUALity:RESult:VOLTage:CREStfactor[:ACTual]?
POWer<m>:QUALity:RESult:VOLTage:CREStfactor:AVERAge?
POWer<m>:QUALity:RESult:VOLTage:CREStfactor:NPEak?
POWer<m>:QUALity:RESult:VOLTage:CREStfactor:PPEak?
POWer<m>:QUALity:RESult:VOLTage:CREStfactor:RMS?
POWer<m>:QUALity:RESult:VOLTage:CREStfactor:STDDev?

Returns the voltage crest factor, the *Peak value / RMS value* value for the power quality analysis.

For details on the statistics, see ["Overview of statistic commands"](#) on page 619.

Suffix:

<m> 1...6, index of the power analysis measurement

Return values:

<StdDev> Range: -1E+26 to 1E+26
Increment: 1E-10
*RST: 0

Usage:

Query only
Asynchronous command

POWer<m>:QUALity:RESult:VOLTage:FREQUency[:ACTual]?
POWer<m>:QUALity:RESult:VOLTage:FREQUency:AVERage?
POWer<m>:QUALity:RESult:VOLTage:FREQUency:NPEak?
POWer<m>:QUALity:RESult:VOLTage:FREQUency:PPEak?
POWer<m>:QUALity:RESult:VOLTage:FREQUency:RMS?
POWer<m>:QUALity:RESult:VOLTage:FREQUency:STDDev?

Returns the voltage frequency value for the power quality analysis.

For details on the statistics, see ["Overview of statistic commands"](#) on page 619.

Suffix:

<m> 1...6, index of the power analysis measurement

Return values:

<StdDev> Range: -1E+26 to 1E+26
Increment: 1E-10
*RST: 0

Usage:

Query only
Asynchronous command

POWer<m>:QUALity:RESult:VOLTage:PEAK[:ACTual]?
POWer<m>:QUALity:RESult:VOLTage:PEAK:AVERage?
POWer<m>:QUALity:RESult:VOLTage:PEAK:NPEak?
POWer<m>:QUALity:RESult:VOLTage:PEAK:PPEak?
POWer<m>:QUALity:RESult:VOLTage:PEAK:RMS?
POWer<m>:QUALity:RESult:VOLTage:PEAK:STDDev?

Returns the voltage peak value, the highest measured magnitude value for the power quality analysis.

For details on the statistics, see ["Overview of statistic commands"](#) on page 619.

Suffix:

<m> 1...6, index of the power analysis measurement

Return values:

<StdDev> Range: -1E+26 to 1E+26
Increment: 1E-10
*RST: 0

Usage: Query only
Asynchronous command

POWER<m>:QUALity:RESult:VOLTage:RMS[:ACTual]?
POWER<m>:QUALity:RESult:VOLTage:RMS:AVERage?
POWER<m>:QUALity:RESult:VOLTage:RMS:NPEak?
POWER<m>:QUALity:RESult:VOLTage:RMS:PPEak?
POWER<m>:QUALity:RESult:VOLTage:RMS:RMS?
POWER<m>:QUALity:RESult:VOLTage:RMS:STDDev?

Returns the root mean square of the voltage for the power quality analysis.

For details on the statistics, see "[Overview of statistic commands](#)" on page 619.

Suffix:
 <m> 1...6, index of the power analysis measurement

Return values:
 <StdDev> Range: -1E+26 to 1E+26
 Increment: 1E-10
 *RST: 0

Usage: Query only
Asynchronous command

17.15.2.3 Power harmonics

Power harmonics setup

| | |
|--|-----|
| POWER<m>:HARMonics:SOURce:CURRENT | 628 |
| POWER<m>:HARMonics:SOURce[:VOLTage] | 629 |
| POWER<m>:HARMonics:STANdard | 629 |
| POWER<m>:HARMonics:FREQuency:EN | 629 |
| POWER<m>:HARMonics:FREQuency:MIL | 630 |
| POWER<m>:HARMonics:FREQuency:RTCA | 630 |
| POWER<m>:HARMonics:STATistics:RESet | 630 |
| POWER<m>:HARMonics:DISPlay:FREQuency:STARt | 630 |
| POWER<m>:HARMonics:DISPlay:FREQuency:STOP | 631 |

POWER<m>:HARMonics:SOURce:CURRENT <CurrentSource>

Sets the channel for the current source input of the power harmonics analysis.

Suffix:
 <m> 1...6, index of the power analysis measurement

Parameters:
 <CurrentSource> C1 | C2 | C3 | C4 | C5 | C6 | C7 | C8

Usage: Asynchronous command

Manual operation: See "[Current](#)" on page 257

POWER<m>:HARMonics:SOURce[:VOLTage] <VoltageSource>

Sets the channel for the voltage source input of the power harmonics analysis.

Suffix:

<m> 1...6, index of the power analysis measurement

Parameters:

<VoltageSource> C1 | C2 | C3 | C4 | C5 | C6 | C7 | C8

Usage: Asynchronous command

Manual operation: See "[Voltage](#)" on page 257

POWER<m>:HARMonics:STANdard <Standard>

Sets a standard for the current harmonic measurement.

Suffix:

<m> 1...6, index of the power analysis measurement

Parameters:

<Standard> ENA | ENB | ENC | END | MIL | RTCA

ENA: EN 61000-3-2 Class A

ENB: EN 61000-3-2 Class B

ENC: EN 61000-3-2 Class C

END: EN 61000-3-2 Class D

MIL: MIL-STD-1399

RTCA: RTCA DO-160

*RST: ENA

Usage: Asynchronous command

Manual operation: See "[Standard](#)" on page 257

POWER<m>:HARMonics:FREQUency:EN <FundFreqEN61000>

Sets the fundamental frequency of the input signal for the EN61000 standard, if [POWER<m>:HARMonics:STANdard](#) is set to ENA / ENB / ENC / END.

Suffix:

<m> 1...6, index of the power analysis measurement

Parameters:

<FundFreqEN61000> F50 | F60 | AUTO

F50: 50 Hz

F60: 60 Hz

AUTO: automatically set

*RST: AUTO

Usage: Asynchronous command

Manual operation: See "[Fund. Freq](#)" on page 257

POWER<m>:HARMonics:FREQUency:MIL <FundFreqMIL>

Sets the fundamental frequency of the input signal for the MIL standard, if **POWER<m>:HARMonics:STANdard** is set to MIL.

Suffix:

<m> 1...6, index of the power analysis measurement

Parameters:

<FundFreqMIL> F60 | F400
 F60: 60 Hz
 F400: 400 Hz
 *RST: F60

Usage: Asynchronous command

Manual operation: See "[Fund. Freq](#)" on page 257

POWER<m>:HARMonics:FREQUency:RTCA <FundFreqRTCA>

Sets the fundamental frequency of the input signal for the RTCA standard, if **POWER<m>:HARMonics:STANdard** is set to RTCA.

Suffix:

<m> 1...6, index of the power analysis measurement

Parameters:

<FundFreqRTCA> F400 | NVF | WVF
 F400: 400 Hz
 NVF
 WVF
 *RST: F400

Usage: Asynchronous command

Manual operation: See "[Fund. Freq](#)" on page 257

POWER<m>:HARMonics:STATistics:RESet

Resets the statistics for the power harmonics analysis.

Suffix:

<m> 1...6, index of the power analysis measurement

Usage:

Setting only
 Asynchronous command

Manual operation: See "[Clear Results](#)" on page 257

POWER<m>:HARMonics:DISPlay:FREQUency:STARt <Frequency>

Sets the start frequency of bar graph display. At least three bars are displayed.

Suffix:
 <m> 1...6, index of the power analysis measurement

Parameters:
 <Frequency> Default unit: Hz

Usage: Asynchronous command

POWER<m>:HARMonics:DISPlay:FREQUency:STOP <Frequency>

Sets the stop frequency of the bar graph display. The maximum value is defined by standard and fundamental frequency.

Suffix:
 <m> 1...6, index of the power analysis measurement

Parameters:
 <Frequency> Default unit: Hz

Usage: Asynchronous command

Power harmonics results

POWER<m>:HARMonics:AVAIlable?

Returns the number of measured harmonics.

Suffix:
 <m> 1...6, index of the power analysis measurement

Return values:
 <Count>

Usage: Query only
 Asynchronous command

POWER<m>:HARMonics:MEASurement:THDFundament[:ACTual]?

Returns the total harmonic distortion relative to fundamental (THDF).

Suffix:
 <m> 1...6, index of the power analysis measurement

Usage: Query only
 Asynchronous command

POWER<m>:HARMonics:MEASurement:THDRms[:ACTual]?

Returns the total harmonic distortion relative to the RMS amplitude (THD RMS).

Suffix:
 <m> 1...6, index of the power analysis measurement

Usage: Query only
Asynchronous command

POWer<m>:HARMonics:RESult<n>:VIOLation?

Queries if the value of n-th harmonic is within the defined limit for the current measurement.

Suffix:
 <m> 1...6, index of the power analysis measurement
 <n> 1...n, index of the harmonics

Return values:
 <Harmonic>

Usage: Query only
Asynchronous command

POWer<m>:HARMonics:RESult<n>[:FREQuency]?

Returns the frequency of the n-th harmonic.

Suffix:
 <m> 1...6, index of the power analysis measurement
 <n> 1...n, index of the harmonics

Return values:
 <Harmonic>

Usage: Query only
Asynchronous command

POWer<m>:HARMonics:MEASurement:FREQuency[:ACTual]?

Returns the frequency of measured harmonics.

Suffix:
 <m> 1...6, index of the power analysis measurement

Return values:
 <Actual> Range: -1E+26 to 1E+26
 Increment: 1E-10
 *RST: 0

Usage: Query only
Asynchronous command

POWer<m>:HARMonics:MEASurement:REALpower[:ACTual]?

Returns the real power. Only available, if `POWer<m>:HARMonics:STANdard` on page 629 is set to `ENC / END`.

Suffix:
 <m> 1...6, index of the power analysis measurement

Return values:
 <Actual> Range: -1E+26 to 1E+26
 Increment: 1E-10
 *RST: 0

Usage: Query only
 Asynchronous command

POWER<m>:HARMonics:RESult<n>:MAGNitude:PERCent:MAXimum?

Returns the maximum magnitude of the n-th harmonic in percent.

Suffix:
 <m> 1...6, index of the power analysis measurement
 <n> 1...n, index of the harmonics

Return values:
 <Harmonic>

Usage: Query only
 Asynchronous command

POWER<m>:HARMonics:RESult<n>:MAGNitude:PERCent:MINimum?

Returns the minimum magnitude of the n-th harmonic in percent.

Suffix:
 <m> 1...6, index of the power analysis measurement
 <n> 1...n, index of the harmonics

Return values:
 <Harmonic>

Usage: Query only
 Asynchronous command

POWER<m>:HARMonics:RESult<n>:MAGNitude:PERCent[:ACTual]?

Returns the magnitude of the n-th harmonic in percent.

Suffix:
 <m> 1...6, index of the power analysis measurement
 <n> 1...n, index of the harmonics

Return values:
 <Harmonic>

Usage: Query only
 Asynchronous command

POWer<m>:HARMonics:RESult<n>:MAGNitude:RMS:MAXimum?

Returns the maximum magnitude of the n-th harmonic in RMS.

Suffix:

<m> 1...6, index of the power analysis measurement

<n> 1...n, index of the harmonics

Return values:

<Harmonic>

Usage:

Query only
Asynchronous command

POWer<m>:HARMonics:RESult<n>:MAGNitude:RMS:MINimum?

Returns the minimum magnitude of the n-th harmonic in RMS.

Suffix:

<m> 1...6, index of the power analysis measurement

<n> 1...n, index of the harmonics

Return values:

<Harmonic>

Usage:

Query only
Asynchronous command

POWer<m>:HARMonics:RESult<n>:MAGNitude:RMS[:ACTual]?

Returns the magnitude of the n-th harmonic in RMS.

Suffix:

<m> 1...6, index of the power analysis measurement

<n> 1...n, index of the harmonics

Return values:

<Harmonic>

Usage:

Query only
Asynchronous command

POWer<m>:HARMonics:MEASurement:FREQUency[:ACTual]?

Returns the frequency of measured harmonics.

Suffix:

<m> 1...6, index of the power analysis measurement

Return values:

<Actual> Range: -1E+26 to 1E+26
Increment: 1E-10
*RST: 0

Usage: Query only
Asynchronous command

POWer<m>:HARMonics:MEASurement:REALpower[:ACTual]?

Returns the real power. Only available, if `POWer<m>:HARMonics:STANdard` on page 629 is set to `ENC / END`.

Suffix:
<m> 1...6, index of the power analysis measurement

Return values:
<Actual> Range: -1E+26 to 1E+26
Increment: 1E-10
*RST: 0

Usage: Query only
Asynchronous command

17.15.2.4 Reference level

| | |
|--|-----|
| <code>POWer<m>:HARMonics:REFLevel<rl>:ABSolute:HYSTeresis</code> | 635 |
| <code>POWer<m>:QUALity:REFLevel<rl>:ABSolute:HYSTeresis</code> | 635 |
| <code>POWer<m>:HARMonics:REFLevel<rl>:ABSolute:LLEVel</code> | 636 |
| <code>POWer<m>:QUALity:REFLevel<rl>:ABSolute:LLEVel</code> | 636 |
| <code>POWer<m>:HARMonics:REFLevel<rl>:ABSolute:MLEVel</code> | 636 |
| <code>POWer<m>:QUALity:REFLevel<rl>:ABSolute:MLEVel</code> | 636 |
| <code>POWer<m>:HARMonics:REFLevel<rl>:ABSolute:ULEVel</code> | 636 |
| <code>POWer<m>:QUALity:REFLevel<rl>:ABSolute:ULEVel</code> | 636 |
| <code>POWer<m>:HARMonics:REFLevel<rl>:LMODE</code> | 637 |
| <code>POWer<m>:QUALity:REFLevel<rl>:LMODE</code> | 637 |
| <code>POWer<m>:HARMonics:REFLevel<rl>:RELative:HYSTeresis</code> | 637 |
| <code>POWer<m>:QUALity:REFLevel<rl>:RELative:HYSTeresis</code> | 637 |
| <code>POWer<m>:HARMonics:REFLevel<rl>:RELative:LOWer</code> | 638 |
| <code>POWer<m>:QUALity:REFLevel<rl>:RELative:LOWer</code> | 638 |
| <code>POWer<m>:HARMonics:REFLevel<rl>:RELative:MIDDLE</code> | 638 |
| <code>POWer<m>:QUALity:REFLevel<rl>:RELative:MIDDLE</code> | 638 |
| <code>POWer<m>:HARMonics:REFLevel<rl>:RELative:MODE</code> | 638 |
| <code>POWer<m>:QUALity:REFLevel<rl>:RELative:MODE</code> | 638 |
| <code>POWer<m>:HARMonics:REFLevel<rl>:RELative:UPPer</code> | 639 |
| <code>POWer<m>:QUALity:REFLevel<rl>:RELative:UPPer</code> | 639 |

POWer<m>:HARMonics:REFLevel<rl>:ABSolute:HYSTeris **<HystAbs>**
POWer<m>:QUALity:REFLevel<rl>:ABSolute:HYSTeris **<HystAbs>**

Defines a hysteresis for the middle reference level. A rise or fall from the middle reference value that does not exceed the hysteresis is rejected as noise.

Suffix:
<m> 1...6, index of the power analysis measurement
<rl> 1...8, index of the reference level set

Parameters:

<HystAbs> Range: 0 to 1E+26
 Increment: 0.001
 *RST: 0.005
 Default unit: V

Usage: Asynchronous command

Manual operation: See "[Hysteresis](#)" on page 261

POWER<m>:HARMonics:REFLevel<rl>:ABSolute:LLEVel <LowerLevel>

POWER<m>:QUALity:REFLevel<rl>:ABSolute:LLEVel <LowerLevel>

Sets the lower reference level in absolute values. This is required, e.g., to determine a fall.

Suffix:

<m> 1...6, index of the power analysis measurement

<rl> 1...8, index of the reference level set

Parameters:

<LowerLevel> Range: -1E+26 to 1E+26
 Increment: 0.001
 *RST: 0
 Default unit: V

Usage: Asynchronous command

Manual operation: See "[Upper level, Middle level, Lower level](#)" on page 260

POWER<m>:HARMonics:REFLevel<rl>:ABSolute:MLEVel <MiddleLevel>

POWER<m>:QUALity:REFLevel<rl>:ABSolute:MLEVel <MiddleLevel>

Sets the middle reference level in absolute values.

Suffix:

<m> 1...6, index of the power analysis measurement

<rl> 1...8, index of the reference level set

Parameters:

<MiddleLevel> Range: -1E+26 to 1E+26
 Increment: 0.001
 *RST: 0
 Default unit: V

Usage: Asynchronous command

Manual operation: See "[Upper level, Middle level, Lower level](#)" on page 260

POWER<m>:HARMonics:REFLevel<rl>:ABSolute:ULEVel <UpperLevel>

POWER<m>:QUALity:REFLevel<rl>:ABSolute:ULEVel <UpperLevel>

Sets the upper reference level in absolute values. This is required to determine a rise.

Suffix:

<m> 1...6, index of the power analysis measurement

<rl> 1...8, index of the reference level set

Parameters:

<UpperLevel> Range: -1E+26 to 1E+26
 Increment: 0.001
 *RST: 0
 Default unit: V

Usage: Asynchronous command

Manual operation: See "[Upper level, Middle level, Lower level](#)" on page 260

POWER<m>:HARMONICS:REFLevel<rl>:LMODe <LevelMode>

POWER<m>:QUALity:REFLevel<rl>:LMODe <LevelMode>

Defines if the reference level is set in absolute or relative values.

Suffix:

<m> 1...6, index of the power analysis measurement

<rl> 1...8, index of the reference level set

Parameters:

<LevelMode> ABS | REL
 *RST: REL

Usage: Asynchronous command

Manual operation: See "[Level mode](#)" on page 260

POWER<m>:HARMONICS:REFLevel<rl>:RELative:HYSTeresis <HystRel>

POWER<m>:QUALity:REFLevel<rl>:RELative:HYSTeresis <HystRel>

Defines a hysteresis for the middle reference level. A rise or fall from the middle reference value that does not exceed the hysteresis is rejected as noise.

Suffix:

<m> 1...6, index of the power analysis measurement

<rl> 1...8, index of the reference level set

Parameters:

<HystRel> Range: 0 to 50
 Increment: 1
 *RST: 10
 Default unit: %

Usage: Asynchronous command

Manual operation: See "[Hysteresis](#)" on page 261

POWer<m>:HARMonics:REFLevel<rl>:RELative:LOWer <LowRefLevRel>

POWer<m>:QUALity:REFLevel<rl>:RELative:LOWer <LowRefLevRel>

Sets the lower relative reference level if **POWer<m>:QUALity:REFLevel<rl>:RELative:MODE** is set to **USER**.

Suffix:

<m> 1...6, index of the power analysis measurement

<rl> 1...8, index of the reference level set

Parameters:

<LowRefLevRel> Range: -100 to 200
 Increment: 1
 *RST: 10
 Default unit: %

Usage: Asynchronous command

Manual operation: See "[Upper level, Middle level, Lower level](#)" on page 261

POWer<m>:HARMonics:REFLevel<rl>:RELative:MIDDLE <MidRefLevRel>

POWer<m>:QUALity:REFLevel<rl>:RELative:MIDDLE <MidRefLevRel>

Sets the middle relative reference level if **POWer<m>:QUALity:REFLevel<rl>:RELative:MODE** is set to **USER**.

Suffix:

<m> 1...6, index of the power analysis measurement

<rl> 1...8, index of the reference level set

Parameters:

<MidRefLevRel> Range: -100 to 200
 Increment: 1
 *RST: 50
 Default unit: %

Usage: Asynchronous command

Manual operation: See "[Upper level, Middle level, Lower level](#)" on page 261

POWer<m>:HARMonics:REFLevel<rl>:RELative:MODE <RelativeLevels>

POWer<m>:QUALity:REFLevel<rl>:RELative:MODE <RelativeLevels>

The lower, middle and upper reference levels, defined as percentages of the high signal level.

Suffix:

<m> 1...6, index of the power analysis measurement

<rl> 1...8, index of the reference level set

Parameters:

<RelativeLevels> FIVE | TEN | TWENTy | USER

FIVE

5/50/95

TEN

10/50/90

TWENTY

20/50/80

USER

Set the reference levels to individual values with `POWER<m>:QUALity:REFLevel<rl>:RELative:LOWer`, `POWER<m>:QUALity:REFLevel<rl>:RELative:MIDDLE`, and `POWER<m>:QUALity:REFLevel<rl>:RELative:UPPer`.

*RST: TEN

Usage: Asynchronous command**Manual operation:** See "Relative levels" on page 260**POWER<m>:HARMonics:REFLevel<rl>:RELative:UPPer <UppRefLevRel>****POWER<m>:QUALity:REFLevel<rl>:RELative:UPPer <UppRefLevRel>**

Sets the upper relative reference level if `POWER<m>:QUALity:REFLevel<rl>:RELative:MODE` on page 638 is set to `USER`.

Suffix:

<m> 1...6, index of the power analysis measurement

<rl> 1...8, index of the reference level set

Parameters:

<UppRefLevRel> Range: -100 to 200

Increment: 1

*RST: 90

Default unit: %

Usage: Asynchronous command**Manual operation:** See "Upper level, Middle level, Lower level" on page 261**17.15.2.5 Power analysis data**

This chapter describes the commands for exporting and loading power analysis measurement data.

`POWER<m>:HARMonics:POWER:DATA:HEADer?`..... 639`POWER<m>:QUALity:POWER:DATA:HEADer?`..... 640`POWER<m>:HARMonics:POWER:DATA[:VALues]`..... 640`POWER<m>:QUALity:POWER:DATA[:VALues]?`..... 641**POWER<m>:HARMonics:POWER:DATA:HEADer?**

Returns the header of the power analysis waveform data. The header contains attributes of the waveform.

Suffix:
 <m> 1...6, index of the power analysis measurement

Example:
 POW1:HARM:DATA:HEAD?
 Harmonic, Frequency, Magnitude (RMS), Magnitude (%), Phase, State, Limit, Margin

Usage:
 Query only
 Asynchronous command

POWER<m>:QUALity:POWER:DATA:HEADer?

Returns the header of the power analysis waveform data. The header contains attributes of the waveform.

Suffix:
 <m> 1...6, index of the power analysis measurement

Example:
 POW1:QUAL:DATA:HEAD?
 Type, Source, Current, Max, Min, Mean, RMS, Std Dev, Event Count, Wave Count

Usage:
 Query only
 Asynchronous command

POWER<m>:HARMonics:POWER:DATA[:VALues] [<Offset>],[<Length>]

Returns the data of the power analysis waveform points for transmission from the instrument to the controlling computer.

Suffix:
 <m> 1...6, index of the power analysis measurement

Example:
 POW:HARM:POW:DATA?

 Harmonics Results,EN 61000 -3-2 Class A

 Harmonic, Frequency, Magnitude (RMS), Magnitude (%), Phase, State, Limit, Margin

 [n], [Hz], [dBuA], [%], [deg], [bool], [dBuA], [dBuA]

 2,44.0999,-18.874,-168.065,0,Fail,0,18.874

 3,4.02182,-27.4326,-244.276,0,Fail,0,27.4326

 7,69.1013,-20.7327,-184.616,0,Fail,0,20.7327

 8,29.9841,61.7368,549.741,0,Fail,0,-61.7368

 11,44.9699,-15.6858,-139.676,0,Fail,0,15.6858

Usage:
 Asynchronous command

POWer<m>:QUALity:POWer:DATA[:VALues]? [<Offset>],[<Length>]

Returns the data of the power analysis waveform points for transmission from the instrument to the controlling computer.

To set the export format, use [FORMat \[: DATA \]](#).

Suffix:

<m> 1...6, index of the power analysis measurement

Query parameters:

<Length>

Example:

POW:QUAL:POW:DATA?

```
Type,Source,Current,Max,Min,Mean,RMS,Std Dev,Event Count,Wave Count
Period,Voltage,nan s,3.40282e+38 s,-3.40282e+38 s,nan s,nan s,nan,0,0
RMS,Voltage,nan V,3.40282e+38 V,-3.40282e+38 V,nan V,nan V,nan,0,0
Chrest Factor,Voltage,nan,3.40282e+38,-3.40282e+38,nan,nan,nan,0,0
Max,Voltage,nan V,3.40282e+38 V,-3.40282e+38 V,nan V,nan V,nan,0,0
RMS,Current,nan A,3.40282e+38 A,-3.40282e+38 A,nan A,nan A,nan,0,0
Chrest Factor,Current,nan,3.40282e+38,-3.40282e+38,nan,nan,nan,0,0
Max,Current,nan A,3.40282e+38 A,-3.40282e+38 A,nan A,nan A,nan,0,0
```

Usage:

Query only
Asynchronous command

17.15.3 Digital voltmeter

This chapter describes the commands for setting up and querying the results of the digital voltmeter.

| | |
|--|-----|
| METer:DVMeter<m>:ENABle? | 641 |
| METer:BANDwidth | 642 |
| METer:DVMeter<m>:ACRMs:ENABle | 642 |
| METer:DVMeter<m>:ACRMs:RESult? | 642 |
| METer:DVMeter<m>:DC:ENABle | 643 |
| METer:DVMeter<m>:DC:RESult? | 643 |
| METer:DVMeter<m>:DCRMs:ENABle | 643 |
| METer:DVMeter<m>:DCRMs:RESult? | 644 |

METer:DVMeter<m>:ENABle?

Queries the state of the voltmeter for the respective channel.

Suffix:
 <m> 1 to 8, depending on instrument model. Index of the analog channel.

Return values:
 <State> ON | OFF
 *RST: OFF

Usage: Query only
 Asynchronous command

METer:BANDwidth <Bandwidth>

Sets the filter bandwidth.

Parameters:

<Bandwidth> B20M | B10M | B5M | B2M | B1M | B500 | B200
 B20M: 20 MHz
 B10M: 10 MHz
 B5M: 5 MHz
 B2M: 2 MHz
 B1M: 1 MHz
 B500: 500 kHz
 B200: 200 kHz
 *RST: B20M

Usage: Asynchronous command

Manual operation: See "[Filter bandwidth](#)" on page 265

METer:DVMeter<m>:ACRMs:ENABLE <ACRMSResults_St>

Enables the AC RMS voltmeter measurement for the respective channel.

Suffix:

<m> 1 to 8, depending on instrument model. Index of the analog channel.

Parameters:

<ACRMSResults_St> ON | OFF
 *RST: OFF

Usage: Asynchronous command

Manual operation: See "[Measurements](#)" on page 265

METer:DVMeter<m>:ACRMs:RESult?

Returns the result of the AC RMS voltmeter measurement.

Suffix:
 <m> 1 to 8, depending on instrument model. Index of the analog channel.

Return values:
 <Results_ACRMS> Range: -1E+26 to 1E+26
 Increment: 0.1
 *RST: 0
 Default unit: V

Usage: Query only
 Asynchronous command

Manual operation: See "[Measurements](#)" on page 265

METer:DVMeter<m>:DC:ENABLE <DCResults_St>

Enables the DC voltmeter measurement for the respective channel.

Suffix:
 <m> 1 to 8, depending on instrument model. Index of the analog channel.

Parameters:
 <DCResults_St> ON | OFF
 *RST: OFF

Usage: Asynchronous command

Manual operation: See "[Measurements](#)" on page 265

METer:DVMeter<m>:DC:RESult?

Returns the result of the DC voltmeter measurement.

Suffix:
 <m> 1 to 8, depending on instrument model. Index of the analog channel.

Return values:
 <Results_DC> Range: -1E+26 to 1E+26
 Increment: 0.1
 *RST: 0
 Default unit: V

Usage: Query only
 Asynchronous command

Manual operation: See "[Measurements](#)" on page 265

METer:DVMeter<m>:DCRMs:ENABLE <DCRMSResults_St>

Enables the DC RMS voltmeter measurement for the respective channel.

Suffix:

<m> 1 to 8, depending on instrument model. Index of the analog channel.

Parameters:

<DCRMSResults_St> ON | OFF

*RST: OFF

Usage:

Asynchronous command

Manual operation: See "[Measurements](#)" on page 265

METer:DVMeter<m>:DCRMs:RESult?

Returns the result of the DC RMS voltmeter measurement.

Suffix:

<m> 1 to 8, depending on instrument model. Index of the analog channel.

Return values:

<Results_DCRMS> Range: -1E+26 to 1E+26

Increment: 0.1

*RST: 0

Default unit: V

Usage:

Query only

Asynchronous command

Manual operation: See "[Measurements](#)" on page 265

17.16 Protocols

- [Configuration settings for all serial protocols](#)..... 644
- [SPI \(option R&S MXO5-K510\)](#)..... 648
- [I²C \(option R&S MXO5-K510\)](#)..... 666
- [UART / RS-232 \(option R&S MXO5-K510\)](#)..... 685
- [CAN \(option R&S MXO5-K520\)](#)..... 700
- [LIN \(option R&S MXO5-K520\)](#)..... 733

17.16.1 Configuration settings for all serial protocols

17.16.1.1 General settings

[SBUS<sb>\[:STATe\]](#)..... 645

[SBUS<sb>:TYPE](#)..... 645

[SBUS<sb>:RESult](#)..... 645

[SBUS<sb>:FORMat](#)..... 645

| | |
|---|-----|
| SBUS<m>:ZCOupling..... | 646 |
| SBUS<m>:THReshold..... | 646 |
| SBUS<m>:SETReflevels..... | 646 |

SBUS<sb>[:STATe] <ProtocolState>

Enables the decoding of the specified bus.

Suffix:

<sb> 1...4, index of the serial bus

Parameters:

<ProtocolState> ON | OFF

Usage: Asynchronous command

SBUS<sb>:TYPE <Protocol Type>

Selects the bus type for analysis. The type of available buses depends on the installed options.

Suffix:

<sb> 1...4, index of the serial bus

Parameters:

<Protocol Type> I2C | SPI | UART | CAN | LIN

Usage: Asynchronous command

Manual operation: See "[Protocol type](#)" on page 286

SBUS<sb>:RESult <ShwResTbl>

Enables a table with decoded data of the serial signal. The function requires the option for the analyzed protocol.

Suffix:

<sb> 1...4, index of the serial bus

Parameters:

<ShwResTbl> ON | OFF

*RST: OFF

Usage: Asynchronous command

Manual operation: See "[Show decode table](#)" on page 288

SBUS<sb>:FORMat <DataFormat>

Sets the number format for decoded data values of the indicated serial bus. It defines the format in the decode table, and in the combs of the decoded signal on the screen.

Suffix:

<sb> 1...4, index of the serial bus

Parameters:

<DataFormat> HEX | OCT | BIN | ASCII | ASCii | SIGN | USIG
 *RST: HEX

Usage: Asynchronous command

Manual operation: See "[Data format](#)" on page 289

SBUS<m>:ZCOupling <ZoomCoupling>

If enabled, the protocol decode zoom and result table are synchronized.

Suffix:

<m> 1...4, index of the serial bus

Parameters:

<ZoomCoupling> ON | OFF
 *RST: OFF

Manual operation: See "[Zoom coupling](#)" on page 289

SBUS<m>:THReshold <ShwThresLines>

If enabled, the threshold lines are displayed in the diagram.

The label of the threshold line is set according to the signal that it is referring to.

Suffix:

<m> 1..4

Parameters:

<ShwThresLines> ON | OFF
 *RST: OFF

Usage: Asynchronous command

Manual operation: See "[Show threshold lines](#)" on page 287

SBUS<m>:SETReflevels

Executes the measurement of reference levels and sets the thresholds to the middle reference level of the measured amplitude.

Suffix:

<m> 1..4

Usage:

Event
 Asynchronous command

17.16.1.2 Export results settings

| | |
|-----------------------------------|-----|
| SBUS<sb>:EXPResult:DETail..... | 647 |
| SBUS<sb>:EXPResult:SAVE..... | 647 |
| SBUS<sb>:EXPResult:TIME..... | 647 |
| SBUS<sb>:EXPResult:EXTension..... | 648 |
| SBUS<sb>:EXPResult:PATH..... | 648 |

SBUS<sb>:EXPResult:DETail <IncludeDetails>

If enabled, includes the detailed results for all frames in the export result file.

Suffix:

<sb> 1...4, index of the serial bus

Parameters:

<IncludeDetails> ON | OFF
*RST: ON

Usage: Asynchronous command

Manual operation: See "[Include details](#)" on page 291

SBUS<sb>:EXPResult:SAVE <FileName>

Saves the selected results to the indicated file.

Suffix:

<sb> 1...4, index of the serial bus

Setting parameters:

<FileName>

Usage: Setting only
Asynchronous command

Manual operation: See "[Save as](#)" on page 292

SBUS<sb>:EXPResult:TIME <IncludeTiming>

If enabled, includes the frame timing in the export result file.

Suffix:

<sb> 1...4, index of the serial bus

Parameters:

<IncludeTiming> ON | OFF
*RST: ON

Usage: Asynchronous command

Manual operation: See "[Include timing](#)" on page 291

SBUS<sb>:EXPResult:EXTension <FileType>

Selects the file format.

Suffix:

<sb> 1...4, index of the serial bus

Parameters:

<FileType> HTML | CSV | XML | PY
*RST: HTML

Usage: Asynchronous command

Manual operation: See "File type" on page 291

SBUS<sb>:EXPResult:PATH <Path>

Sets the path where the protocol export files are stored. On the instrument, the default path is `home/storage/userData/Protocol`. You can create subfolders in this folder.

Suffix:

<sb> 1...4, index of the serial bus

Parameters:

<Path> String parameter

Usage: Asynchronous command

Manual operation: See "Save as" on page 292

17.16.2 SPI (option R&S MXO5-K510)

Before R&S MXO 5 can accept the specific bus commands, make sure that:

- The decoding of the specified bus is enabled with `SBUS<sb>[:STATe]`.
- The bus is set to the correct type with `SBUS<sb>:TYPE`.

| | |
|--|-----|
| • Configuration | 648 |
| • Filter | 655 |
| • Trigger | 660 |
| • Decode results | 661 |

17.16.2.1 Configuration

| | |
|---|-----|
| SBUS<sb>:SPI:BORDER | 649 |
| SBUS<sb>:SPI:FRCondition | 649 |
| SBUS<sb>:SPI:CSElect:HYSteresis | 650 |
| SBUS<sb>:SPI:CSElect:POLarity | 650 |
| SBUS<sb>:SPI:CSElect:SOURce | 650 |
| SBUS<sb>:SPI:CSElect:THReshold | 650 |
| SBUS<sb>:SPI:MISO:HYSteresis | 651 |

| | |
|-----------------------------------|-----|
| SBUS<sb>:SPI:MISO:POLarity..... | 651 |
| SBUS<sb>:SPI:MISO:SOURce..... | 651 |
| SBUS<sb>:SPI:MISO:THReshold..... | 652 |
| SBUS<sb>:SPI:MOSI:HYSTeresis..... | 652 |
| SBUS<sb>:SPI:MOSI:POLarity..... | 652 |
| SBUS<sb>:SPI:MOSI:SOURce..... | 652 |
| SBUS<sb>:SPI:MOSI:THReshold..... | 653 |
| SBUS<sb>:SPI:SCLK:HYSTeresis..... | 653 |
| SBUS<sb>:SPI:SCLK:SOURce..... | 653 |
| SBUS<sb>:SPI:SCLK:THReshold..... | 654 |
| SBUS<sb>:SPI:TIMeout..... | 654 |
| SBUS<sb>:SPI:WSIZe..... | 654 |
| SBUS<sb>:SPI:MISO:POSition..... | 654 |
| SBUS<sb>:SPI:MISO:SCALe..... | 655 |
| SBUS<sb>:SPI:MOSI:POSition..... | 655 |
| SBUS<sb>:SPI:MOSI:SCALe..... | 655 |

SBUS<sb>:SPI:BORDER <BitOrder>

Selects the bit order, which determines if the data of the messages starts with MSB (most significant bit) or LSB (least significant bit).

Suffix:

<sb> 1...4, index of the serial bus

Parameters:

<BitOrder> LSBF | MSBF
*RST: MSBF

Usage: Asynchronous command

Manual operation: See "[Bit order](#)" on page 296

SBUS<sb>:SPI:FRCondition <FrameCondition>

Defines the start of a frame. A frame contains a number of successive words, at least one word.

Suffix:

<sb> 1...4, index of the serial bus

Parameters:

<FrameCondition> CS | CLKTimeout

CS

Start and end of the frame is defined by the active state of the sub select signal, see [SBUS<sb>:SPI:CSElect:POLarity](#).

CLKTimeout

Defines a timeout on the clock line SCLK as limiter between two frames. The timeout condition is used for SPI connections without a CS line.

*RST: CS

Usage: Asynchronous command
Manual operation: See "[Frame condition](#)" on page 298

SBUS<sb>:SPI:CSElect:HYSteresis <Hysteresis>

Sets a value for the hysteresis for the CS channel.

Suffix:
 <sb> 1...4, index of the serial bus

Parameters:
 <Hysteresis>

Usage: Asynchronous command
Manual operation: See "[Threshold](#)" on page 296

SBUS<sb>:SPI:CSElect:POLarity <CSPolarity>

Selects if the transmitted signal for the respective line is active high (high = 1) or active low (low = 1).

Suffix:
 <sb> 1...4, index of the serial bus

Parameters:
 <CSPolarity> ACTLow | ACTHigh
 *RST: ACTLow

Usage: Asynchronous command
Manual operation: See "[Polarity: MOSI, MISO, CS](#)" on page 296

SBUS<sb>:SPI:CSElect:SOURce CSSource

Sets the input channel of the CS line.

Suffix:
 <sb> 1...4, index of the serial bus

Parameters:
 CSSource C1 | C2 | C3 | C4 | C5 | C6 | C7 | C8 | D0 | D1 | D2 | D3 | D4 | D5
 | D6 | D7 | D8 | D9 | D10 | D11 | D12 | D13 | D14 | D15 | M1 | M2
 | M3 | M4 | M5 | M6 | M7 | M8 | R1 | R2 | R3 | R4 | R5 | R6 | R7 |
 R8

Usage: Asynchronous command
Manual operation: See "[SCLK,MOSI,MISO,CS](#)" on page 295

SBUS<sb>:SPI:CSElect:THReshold <Threshold>

Sets a user-defined threshold value for the line.

Suffix:
 <sb> 1...4, index of the serial bus

Parameters:
 <Threshold>

Usage: Asynchronous command

Manual operation: See "[Threshold](#)" on page 296

SBUS<sb>:SPI:MISO:HYSTEResis <Hysteresis>

Sets a value for the hysteresis for the MISO channel.

Suffix:
 <sb> 1...4, index of the serial bus

Parameters:
 <Hysteresis>

Usage: Asynchronous command

Manual operation: See "[Threshold](#)" on page 296

SBUS<sb>:SPI:MISO:POLarity <MISOPolarity>

Selects if the transmitted signal for the respective line is active high (high = 1) or active low (low = 1).

Suffix:
 <sb> 1...4, index of the serial bus

Parameters:
 <MISOPolarity> ACTLow | ACTHigh
 *RST: ACTHigh

Usage: Asynchronous command

Manual operation: See "[Polarity: MOSI, MISO, CS](#)" on page 296

SBUS<sb>:SPI:MISO:SOURce MISOSource

Sets the input channel of the MISO line.

Suffix:
 <sb> 1...4, index of the serial bus

Parameters:
 MISOSource C1 | C2 | C3 | C4 | C5 | C6 | C7 | C8 | D0 | D1 | D2 | D3 | D4 | D5
 | D6 | D7 | D8 | D9 | D10 | D11 | D12 | D13 | D14 | D15 | M1 | M2
 | M3 | M4 | M5 | M6 | M7 | M8 | R1 | R2 | R3 | R4 | R5 | R6 | R7 |
 R8

Usage: Asynchronous command

Manual operation: See "[SCLK,MOSI,MISO,CS](#)" on page 295

SBUS<sb>:SPI:MISO:THReshold <Threshold>

Sets a user-defined threshold value for the line.

Suffix:

<sb> 1...4, index of the serial bus

Parameters:

<Threshold>

Usage: Asynchronous command

Manual operation: See "[Threshold](#)" on page 296

SBUS<sb>:SPI:MOSI:HYSTeresis <Hysteresis>

Sets a value for the hysteresis for the MOSI channel.

Suffix:

<sb> 1...4, index of the serial bus

Parameters:

<Hysteresis>

Usage: Asynchronous command

Manual operation: See "[Threshold](#)" on page 296

SBUS<sb>:SPI:MOSI:POLarity <MOSIPolarity>

Selects if the transmitted signal for the respective line is active high (high = 1) or active low (low = 1).

Suffix:

<sb> 1...4, index of the serial bus

Parameters:

<MOSIPolarity> ACTLow | ACTHigh
*RST: ACTHigh

Usage: Asynchronous command

Manual operation: See "[Polarity: MOSI, MISO, CS](#)" on page 296

SBUS<sb>:SPI:MOSI:SOURce MOSISource

Sets the input channel of the MOSI line.

Suffix:

<sb> 1...4, index of the serial bus

Parameters:

MOSISource C1 | C2 | C3 | C4 | C5 | C6 | C7 | C8 | D0 | D1 | D2 | D3 | D4 | D5
| D6 | D7 | D8 | D9 | D10 | D11 | D12 | D13 | D14 | D15 | M1 | M2
| M3 | M4 | M5 | M6 | M7 | M8 | R1 | R2 | R3 | R4 | R5 | R6 | R7 |
R8

Usage: Asynchronous command

Manual operation: See "[SCLK,MOSI,MISO,CS](#)" on page 295

SBUS<sb>:SPI:MOSI:THReshold <Threshold>

Sets a user-defined threshold value for the line.

Suffix:

<sb> 1...4, index of the serial bus

Parameters:

<Threshold>

Usage: Asynchronous command

Manual operation: See "[Threshold](#)" on page 296

SBUS<sb>:SPI:SCLK:HYSTeresis <Hysteresis>

Sets a value for the hysteresis for the SCLK channel.

Suffix:

<sb> 1...4, index of the serial bus

Parameters:

<Hysteresis>

Usage: Asynchronous command

Manual operation: See "[Threshold](#)" on page 296

SBUS<sb>:SPI:SCLK:SOURce SCLKSource

Sets the input channel of the SCLK line.

Suffix:

<sb> 1...4, index of the serial bus

Parameters:

SCLKSource C1 | C2 | C3 | C4 | C5 | C6 | C7 | C8 | D0 | D1 | D2 | D3 | D4 | D5
| D6 | D7 | D8 | D9 | D10 | D11 | D12 | D13 | D14 | D15 | M1 | M2
| M3 | M4 | M5 | M6 | M7 | M8 | R1 | R2 | R3 | R4 | R5 | R6 | R7 |
R8

Usage: Asynchronous command

Manual operation: See "[SCLK,MOSI,MISO,CS](#)" on page 295

SBUS<sb>:SPI:SCLK:THReshold <Threshold>

Sets a user-defined threshold value for the line.

Suffix:

<sb> 1...4, index of the serial bus

Parameters:

<Threshold>

Usage: Asynchronous command

Manual operation: See "[Threshold](#)" on page 296

SBUS<sb>:SPI:TIMEout <ClockTimeout>

Sets the minimum clock idle time if a timeout on the clock line SCLK is used as limiter between two frames.

Suffix:

<sb> 1...4, index of the serial bus

Parameters:

<ClockTimeout> Range: 5E-08 to 10
Increment: 1E-06
*RST: 0.001
Default unit: s

Usage: Asynchronous command

Manual operation: See "[Timeout](#)" on page 298

SBUS<sb>:SPI:WSize <WordLength>

Sets the word length (or symbol size), which is the number of bits in a message. The maximum word length is 32 bit.

Suffix:

<sb> 1...4, index of the serial bus

Parameters:

<WordLength> Range: 4 to 32
Increment: 1
*RST: 8

Usage: Asynchronous command

Manual operation: See "[Word length](#)" on page 296

SBUS<sb>:SPI:MISO:POStion <SPI position>

Sets the vertical position of the MISO signal.

Suffix:

<sb> 1...4, index of the serial bus

Parameters:

<SPI position>

Usage: Asynchronous command**SBUS<sb>:SPI:MISO:SCALE <SPI scale>**

Set the vertical scale of the MISO signal.

Suffix:

<sb> 1...4, index of the serial bus

Parameters:

<SPI scale>

Usage: Asynchronous command**SBUS<sb>:SPI:MOSI:POSITION <SPI position>**

Sets the vertical position of the MOSI signal.

Suffix:

<sb> 1...4, index of the serial bus

Parameters:

<SPI position>

Usage: Asynchronous command**SBUS<sb>:SPI:MOSI:SCALE <SPI scale>**

Set the vertical scale of the MOSI signal.

Suffix:

<sb> 1...4, index of the serial bus

Parameters:

<SPI scale>

Usage: Asynchronous command**17.16.2.2 Filter**

| | |
|--|-----|
| SBUS<sb>:SPI:FILTer:ENABle..... | 656 |
| SBUS<sb>:SPI:FILTer:BIT..... | 656 |
| SBUS<sb>:SPI:FILTer:FRAMe<fr>:FLD<fl>:BIT..... | 656 |
| SBUS<sb>:SPI:FILTer:DMAX..... | 656 |
| SBUS<sb>:SPI:FILTer:FRAMe<fr>:FLD<fl>:DMAX..... | 656 |
| SBUS<sb>:SPI:FILTer:DMIN..... | 657 |
| SBUS<sb>:SPI:FILTer:FRAMe<fr>:FLD<fl>:DMIN..... | 657 |
| SBUS<sb>:SPI:FILTer:DOPerator..... | 657 |
| SBUS<sb>:SPI:FILTer:FRAMe<fr>:FLD<fl>:DOPerator..... | 657 |
| SBUS<sb>:SPI:FILTer:ERENable..... | 657 |

| | |
|--|-----|
| SBUS<sb>:SPI:FILTer:ERRor<n>:ENABle..... | 657 |
| SBUS<sb>:SPI:FILTer:FIENable..... | 658 |
| SBUS<sb>:SPI:FILTer:FRAMe<fr>:FLD<fl>:ENABle..... | 658 |
| SBUS<sb>:SPI:FILTer:FRENable..... | 658 |
| SBUS<sb>:SPI:FILTer:FRAMe<fr>:ENABle..... | 658 |
| SBUS<sb>:SPI:FILTer:IMAX..... | 658 |
| SBUS<sb>:SPI:FILTer:FRAMe<fr>:FLD<fl>:IMAX..... | 658 |
| SBUS<sb>:SPI:FILTer:IMIN..... | 659 |
| SBUS<sb>:SPI:FILTer:FRAMe<fr>:FLD<fl>:IMIN..... | 659 |
| SBUS<sb>:SPI:FILTer:IOPerator..... | 659 |
| SBUS<sb>:SPI:FILTer:FRAMe<fr>:FLD<fl>:IOPerator..... | 659 |

SBUS<sb>:SPI:FILTer:ENABle <Enable>

Enables the filtering on SPI frames. Only the frames that match the selected filter conditions are displayed.

Suffix:

<sb> 1...4, index of the serial bus

Parameters:

<Enable> ON | OFF
*RST: ON

Usage: Asynchronous command

SBUS<sb>:SPI:FILTer:BIT <Frame>,<Field>,<Bit>
SBUS<sb>:SPI:FILTer:FRAMe<fr>:FLD<fl>:BIT <BitState>

Sets the operator for the data pattern in the selected field of the selected frame.

Suffix:

<sb> 1...4, index of the serial bus

<fr> index of the frame

<fl> index of the field

Parameters:

<BitState> ONE | ZERO
*RST: ZERO

Usage: Asynchronous command

Manual operation: See "Edit" on page 300

SBUS<sb>:SPI:FILTer:DMAX <Frame>,<Field>,<Data>
SBUS<sb>:SPI:FILTer:FRAMe<fr>:FLD<fl>:DMAX <Data_Max>

Sets the end value of a data pattern range if the operator is set to INRange or OORANGE.

Suffix:

<sb> 1...4, index of the serial bus

<fr> index of the frame

<fl> index of the field

Parameters:

<Data_Max>

Usage: Asynchronous command

Manual operation: See "Edit" on page 300

SBUS<sb>:SPI:FILTER:DMIN <Frame>,<Field>,<Data>

SBUS<sb>:SPI:FILTER:FRAME<fr>:FLD<fl>:DMIN <Data_Min>

Specifies the data pattern, or sets the start value of a data pattern range.

Suffix:

<sb> 1...4, index of the serial bus

<fr> index of the frame

<fl> index of the field

Parameters:

<Data_Min>

Usage: Asynchronous command

Manual operation: See "Edit" on page 300

SBUS<sb>:SPI:FILTER:DOPerator <Frame>,<Field>,<Operator>

SBUS<sb>:SPI:FILTER:FRAME<fr>:FLD<fl>:DOPerator <Data_Operator>

Sets the operator for the data pattern in the selected field of the selected frame.

Suffix:

<sb> 1...4, index of the serial bus

<fr> index of the frame

<fl> index of the field

Parameters:

<Data_Operator> EQUal | NEQual | LTHan | LETHan | GTHan | GETHan |
INRange | OORange
*RST: EQUal

Usage: Asynchronous command

Manual operation: See "Edit" on page 300

SBUS<sb>:SPI:FILTER:ERENable <ErrorName>,<Enabler>

SBUS<sb>:SPI:FILTER:ERRor<n>:ENABLE <Enable>

Defines the error type to be filtered on.

Suffix:
 <sb> 1...4, index of the serial bus
 <n> index of the error

Parameters:
 <Enable> ON | OFF
 *RST: ON

Usage: Asynchronous command

Manual operation: See "Error type" on page 301

SBUS<sb>:SPI:FILTER:FIENable <Frame>,<Field>,<Enabler>
SBUS<sb>:SPI:FILTER:FRAME<fr>:FLD<fl>:ENABLE <CondEnabler>

Enables or disables the checking condition for the selected field of the selected frame.

Suffix:
 <sb> 1...4, index of the serial bus
 <fr> index of the frame
 <fl> index of the field

Parameters:
 <CondEnabler> ON | OFF
 *RST: OFF

Usage: Asynchronous command

Manual operation: See "Edit" on page 300

SBUS<sb>:SPI:FILTER:FRENable <Frame>,<Enabler>
SBUS<sb>:SPI:FILTER:FRAME<fr>:ENABLE <Enable>

Enables or disables the checking condition for the selected frame.

Suffix:
 <sb> 1...4, index of the serial bus
 <fr> index of the frame

Parameters:
 <Enable> ON | OFF
 *RST: ON

Usage: Asynchronous command

Manual operation: See "Frame type" on page 299

SBUS<sb>:SPI:FILTER:IMAX <Frame>,<Field>,<Data>
SBUS<sb>:SPI:FILTER:FRAME<fr>:FLD<fl>:IMAX <Index_Max>

Sets the end value of an index range if the operator is set to INRange.

Suffix:

| | |
|------|--------------------------------|
| <sb> | 1...4, index of the serial bus |
| <fr> | index of the frame |
| <fl> | index of the field |

Parameters:

| | |
|-------------|-------------------|
| <Index_Max> | Range: 1 to 65535 |
| | Increment: 1 |
| | *RST: 65535 |

Usage: Asynchronous command

Manual operation: See ["Edit"](#) on page 300

SBUS<sb>:SPI:FILTER:IMIN <Frame>,<Field>,<Data>

SBUS<sb>:SPI:FILTER:FRAME<fr>:FLD<fl>:IMIN <Index_Min>

Specifies the index, or sets the start value of an index range.

Suffix:

| | |
|------|--------------------------------|
| <sb> | 1...4, index of the serial bus |
| <fr> | index of the frame |
| <fl> | index of the field |

Parameters:

| | |
|-------------|-------------------|
| <Index_Min> | Range: 1 to 65535 |
| | Increment: 1 |
| | *RST: 1 |

Usage: Asynchronous command

Manual operation: See ["Edit"](#) on page 300

SBUS<sb>:SPI:FILTER:IOperator <Frame>,<Field>,<Operator>

SBUS<sb>:SPI:FILTER:FRAME<fr>:FLD<fl>:IOperator <Index_Operator>

Sets the operator for the index in the selected field of the selected frame.

Suffix:

| | |
|------|--------------------------------|
| <sb> | 1...4, index of the serial bus |
| <fr> | index of the frame |
| <fl> | index of the field |

Parameters:

| | |
|------------------|-------------------------|
| <Index_Operator> | EQUAL INRange RANGE |
| | *RST: INRange |

Usage: Asynchronous command

Manual operation: See ["Edit"](#) on page 300

17.16.2.3 Trigger

Trigger commands for serial buses affect the current trigger source. Therefore, set the trigger source to the required serial bus with `TRIGger:EVENT<ev>:SOURCE` before sending the bus-specific trigger commands.

| | |
|--|-----|
| <code>TRIGger:SPI:TYPE</code> | 660 |
| <code>TRIGger:SPI:DMINpattern</code> | 660 |
| <code>TRIGger:SPI:DPOSITION</code> | 660 |
| <code>TRIGger:SPI:FCONDITION</code> | 661 |
| <code>TRIGger:SPI:PALignment</code> | 661 |

`TRIGger:SPI:TYPE` <Type>

Selects the trigger type for SPI analysis.

Parameters:

<Type> FRStart | FRENd | MOSI | MISO

FRStart

Triggers on the beginning of the frame.

FRENd

Triggers on the end of the frame.

MOSI

Triggers on a specified data pattern in that is expected on the MOSI line.

MISO

Triggers on a specified data pattern in that is expected on the MISO line.

*RST: FRStart

Usage: Asynchronous command

Manual operation: See "[Type](#)" on page 302

`TRIGger:SPI:DMINpattern` <DataPattern>

Specifies a data bit pattern, or sets the start value of a pattern range.

Parameters:

<DataPattern>

Usage: Asynchronous command

Manual operation: See "[Data](#)" on page 303

`TRIGger:SPI:DPOSITION` <DataPosition>

Sets the number of bits or words to be ignored before the first bit or word of interest. The effect is defined by `TRIGger:SPI:PALignment`.

Parameters:

<DataPosition> Range: 1 to 4096
 Increment: 1
 *RST: 1

Usage: Asynchronous command

Manual operation: See "[Position](#)" on page 303

TRIGger:SPI:FCONdition <DataOperator>

Selects the operator for the MISO and MOSI pattern.

Parameters:

<DataOperator> EQUal | NEQUal | LTHan | LETHan | GTHan | GETHan
 *RST: EQUal

Usage: Asynchronous command

Manual operation: See "[Data](#)" on page 303

TRIGger:SPI:PALignment <DataAlignment>

Defines how the specified data pattern is searched.

Parameters:

<DataAlignment> WORD | BIT

WORD

The pattern is matched only at word boundaries.

BIT

Bit-by bit: the pattern can be at any position in the data word.

*RST: WORD

Usage: Asynchronous command

Manual operation: See "[Search mode](#)" on page 303

17.16.2.4 Decode results

| | |
|---|-----|
| SBUS<sb>:SPI:FCOunt? | 662 |
| SBUS<sb>:SPI:FRAMe<fr>:BITRate? | 662 |
| SBUS<sb>:SPI:FRAMe<fr>:COUNT? | 662 |
| SBUS<sb>:SPI:FRAMe<fr>:DATA? | 662 |
| SBUS<sb>:SPI:FRAMe<fr>:STARt? | 663 |
| SBUS<sb>:SPI:FRAMe<fr>:STATus? | 663 |
| SBUS<sb>:SPI:FRAMe<fr>:STOP? | 664 |
| SBUS<sb>:SPI:FRAMe<fr>:WCOunt? | 664 |
| SBUS<sb>:SPI:FRAMe<fr>:WORD<w>:FMISo? | 664 |
| SBUS<sb>:SPI:FRAMe<fr>:WORD<w>:FMOSi? | 664 |
| SBUS<sb>:SPI:FRAMe<fr>:WORD<w>:MISO? | 665 |

| | |
|--|-----|
| SBUS<sb>:SPI:FRAMe<fr>:WORD<w>:MOSI?..... | 665 |
| SBUS<sb>:SPI:FRAMe<fr>:WORD<w>:START?..... | 665 |
| SBUS<sb>:SPI:FRAMe<fr>:WORD<w>:STOP?..... | 666 |

SBUS<sb>:SPI:FCOunt?

Returns the number of decoded frames.

Suffix:

<sb> 1...4, index of the serial bus

Return values:

<Count>

Usage:

Query only
Asynchronous command

SBUS<sb>:SPI:FRAMe<fr>:BITRate?

Returns the bit rate of the specified frame.

Suffix:

<sb> 1...4, index of the serial bus

<fr> index of the frame

Return values:

<PrimaryBitRate> Range: 0 to 100000000000
Increment: 1
*RST: 0
Default unit: bps

Usage:

Query only
Asynchronous command

SBUS<sb>:SPI:FRAMe<fr>:COUNT?

Returns the number of decoded frames.

Suffix:

<sb> 1...4, index of the serial bus

<fr> *
Not relevant.

Return values:

<Count> Total number of decoded frames.

Usage:

Query only
Asynchronous command

SBUS<sb>:SPI:FRAMe<fr>:DATA?

Returns the data words of the specified frame.

Suffix:

<sb> 1...4, index of the serial bus

<fr> index of the frame

Return values:

<FrameData> Comma-separated sequence of integer values (N, L1, R1,..., LN, RN). N is the number of word pairs in the frame, and {L1,R1} ...{LN,RN} are the value pairs. The values Lx and Rx are associated with the MOSI and the MISO channel, respectively. If a channel is disabled, an empty value is returned.

Usage:

Query only
Asynchronous command

SBUS<sb>:SPI:FRAMe<fr>:START?

Returns the start time of the specified frame.

Suffix:

<sb> 1...4, index of the serial bus

<fr> index of the frame

Return values:

<FrameStart> Range: -1E+26 to 1E+26
Increment: 1E-10
*RST: 0
Default unit: s

Usage:

Query only
Asynchronous command

SBUS<sb>:SPI:FRAMe<fr>:STATUs?

Returns the overall state of the specified frame.

Suffix:

<sb> 1...4, index of the serial bus

<fr> index of the frame

Return values:

<FrameState> OK | VOID | INComplete | LENGth
OK: the frame is valid.
VOID: the frame is empty.
INComplete: INComplete word. The word does not have the expected word length.
LENGth: The frame is not contained in the acquisition.
*RST: OK

Usage:

Query only
Asynchronous command

SBUS<sb>:SPI:FRAME<fr>:STOP?

Returns the end time of the specified frame.

Suffix:

<sb> 1...4, index of the serial bus
<fr> index of the frame

Return values:

<FrameStop> Range: -1E+26 to 1E+26
Increment: 1E-10
*RST: 0
Default unit: s

Usage:

Query only
Asynchronous command

SBUS<sb>:SPI:FRAME<fr>:WCOunt?

Returns the number of words in the specified frame.

Suffix:

<sb> 1...4, index of the serial bus
<fr> index of the frame

Return values:

<FrameWordCount> Range: 0 to 4096
Increment: 1
*RST: 0

Usage:

Query only
Asynchronous command

SBUS<sb>:SPI:FRAME<fr>:WORD<w>:FMISo?

Returns the formatted value of the specified word on the MISO line.

Suffix:

<sb> 1...4, index of the serial bus
<fr> index of the frame
<w> index of the word

Return values:

<FormattedMISOVal>

Usage:

Query only
Asynchronous command

SBUS<sb>:SPI:FRAME<fr>:WORD<w>:FMOSi?

Returns the formatted value of the specified word on the MOSI line.

Suffix:

<sb> 1...4, index of the serial bus
 <fr> index of the frame
 <w> index of the word

Return values:

<FormattedMOSIVal>

Usage:

Query only
 Asynchronous command

SBUS<sb>:SPI:FRAME<fr>:WORD<w>:MISO?

Returns the data value of the specified word on the MISO line.

Suffix:

<sb> 1...4, index of the serial bus
 <fr> index of the frame
 <w> index of the word

Return values:

<MISOValue> Range: 0 to 4294967295
 Increment: 1
 *RST: 0

Usage:

Query only
 Asynchronous command

SBUS<sb>:SPI:FRAME<fr>:WORD<w>:MOSI?

Returns the data value of the specified word on the MOSI line.

Suffix:

<sb> 1...4, index of the serial bus
 <fr> index of the frame
 <w> index of the word

Return values:

<MOSIValue> Range: 0 to 4294967295
 Increment: 1
 *RST: 0

Usage:

Query only
 Asynchronous command

SBUS<sb>:SPI:FRAME<fr>:WORD<w>:START?

Returns the start time of the specified data word.

Suffix:

| | |
|------|--------------------------------|
| <sb> | 1...4, index of the serial bus |
| <fr> | index of the frame |
| <w> | index of the word |

Return values:

| | |
|------------------|------------------------|
| <FrameWordStart> | Range: -1E+26 to 1E+26 |
| | Increment: 1E-10 |
| | *RST: 0 |
| | Default unit: s |

Usage:

Query only
Asynchronous command

SBUS<sb>:SPI:FRAMe<fr>:WORD<w>:STOP?

Returns the end time of the specified data word.

Suffix:

| | |
|------|--------------------------------|
| <sb> | 1...4, index of the serial bus |
| <fr> | index of the frame |
| <w> | index of the word |

Return values:

| | |
|-----------------|------------------------|
| <FrameWordStop> | Range: -1E+26 to 1E+26 |
| | Increment: 1E-10 |
| | *RST: 0 |
| | Default unit: s |

Usage:

Query only
Asynchronous command

17.16.3 I²C (option R&S MXO5-K510)

Before R&S MXO 5 can accept the specific bus commands, make sure that:

- The decoding of the specified bus is enabled with `SBUS<sb>[:STATe]`.
- The bus is set to the correct type with `SBUS<sb>:TYPE`.

| | |
|--|-----|
| • Configuration | 666 |
| • Trigger | 669 |
| • Filter | 673 |
| • Decode results | 677 |

17.16.3.1 Configuration

| | |
|---|-----|
| SBUS<sb>:I2C:SCL:HYSTerisis | 667 |
| SBUS<sb>:I2C:SCL:SOURce | 667 |
| SBUS<sb>:I2C:SCL:THReshold | 667 |

| | |
|----------------------------------|-----|
| SBUS<sb>:I2C:SDA:HYSteresis..... | 668 |
| SBUS<sb>:I2C:SDA:SOURce..... | 668 |
| SBUS<sb>:I2C:SDA:THReshold..... | 668 |
| SBUS<sb>:I2C:SDA:POSition..... | 668 |
| SBUS<sb>:I2C:SDA:SCALe..... | 669 |
| SBUS<sb>:I2C:SYMBols..... | 669 |
| SBUS<sb>:I2C:NEWLlist..... | 669 |

SBUS<sb>:I2C:SCL:HYSteresis <Hysteresis>

Sets a hysteresis value for the clock line.

Suffix:

<sb> 1...4, index of the serial bus

Parameters:

<Hysteresis>

Usage: Asynchronous command

Manual operation: See "[Threshold](#)" on page 312

SBUS<sb>:I2C:SCL:SOURce SCLSource

Selects the waveform source of the clock line.

Suffix:

<sb> 1...4, index of the serial bus

Parameters:

SCLSource C1 | C2 | C3 | C4 | C5 | C6 | C7 | C8 | D0 | D1 | D2 | D3 | D4 | D5
| D6 | D7 | D8 | D9 | D10 | D11 | D12 | D13 | D14 | D15 | M1 | M2
| M3 | M4 | M5 | M6 | M7 | M8 | R1 | R2 | R3 | R4 | R5 | R6 | R7 |
R8

Usage: Asynchronous command

Manual operation: See "[SCL source](#)" on page 312

SBUS<sb>:I2C:SCL:THReshold <Threshold>

Sets a user-defined threshold value for the clock line.

Suffix:

<sb> 1...4, index of the serial bus

Parameters:

<Threshold>

Usage: Asynchronous command

Manual operation: See "[Threshold](#)" on page 312

SBUS<sb>:I2C:SDA:HYSteresis <Hysteresis>

Sets a hysteresis value for the data line.

Suffix:

<sb> 1...4, index of the serial bus

Parameters:

<Hysteresis>

Usage: Asynchronous command

Manual operation: See "[Threshold](#)" on page 312

SBUS<sb>:I2C:SDA:SOURce SDASource

Sets the source channel to which the data line is connected.

Suffix:

<sb> 1...4, index of the serial bus

Parameters:

SDASource C1 | C2 | C3 | C4 | C5 | C6 | C7 | C8 | D0 | D1 | D2 | D3 | D4 | D5
| D6 | D7 | D8 | D9 | D10 | D11 | D12 | D13 | D14 | D15 | M1 | M2
| M3 | M4 | M5 | M6 | M7 | M8 | R1 | R2 | R3 | R4 | R5 | R6 | R7 |
R8

Usage: Asynchronous command

Manual operation: See "[SDA source](#)" on page 312

SBUS<sb>:I2C:SDA:THReshold <Threshold>

Sets a user-defined threshold value for the data line.

Suffix:

<sb> 1...4, index of the serial bus

Parameters:

<Threshold>

Usage: Asynchronous command

Manual operation: See "[Threshold](#)" on page 312

SBUS<sb>:I2C:SDA:POSition <sda position>

Sets the vertical position of the SDA signal.

Suffix:

<sb> 1...4, index of the serial bus

Parameters:

<sda position>

Usage: Asynchronous command

SBUS<sb>:I2C:SDA:SCALE <sda scale>

Set the vertical scale of the SDA I2C signal.

Suffix:

<sb> 1...4, index of the serial bus

Parameters:

<sda scale>

Usage: Asynchronous command

SBUS<sb>:I2C:SYMBOLs <ShowSymbols>

Activates the symbol list to be used for decoding.

Suffix:

<sb> 1...4, index of the serial bus

Parameters:

<ShowSymbols> ON | OFF
*RST: OFF

Usage: Asynchronous command

Manual operation: See "[Show symbols](#)" on page 313

SBUS<sb>:I2C:NEWList <FileName>

Loads a symbol list file.

Suffix:

<sb> 1...4, index of the serial bus

Setting parameters:

<FileName> String parameter with path and file name.

Example:

```
SBUS1:I2C:NEWList
'home/storage/userData/Protocol/I2C.csv'
SBUS1:I2C:SYMBOLs ON
```

Usage: Setting only
Asynchronous command

Manual operation: See "[Show symbols](#)" on page 313

17.16.3.2 Trigger

Trigger commands for serial buses affect the current trigger source. Therefore, set the trigger source to the required serial bus with **TRIGger:EVENT<ev>:SOURCE** before sending the bus-specific trigger commands.

| | |
|--|-----|
| TRIGger:I2C:TYPE | 670 |
| TRIGger:I2C:ACCEss | 670 |
| TRIGger:I2C:ACONdition | 671 |

| | |
|-----------------------------|-----|
| TRIGger:I2C:ADDRess..... | 671 |
| TRIGger:I2C:ADDTTo..... | 671 |
| TRIGger:I2C:ADNack..... | 671 |
| TRIGger:I2C:AMODE..... | 672 |
| TRIGger:I2C:DCondition..... | 672 |
| TRIGger:I2C:DMIN..... | 672 |
| TRIGger:I2C:DPOStion..... | 672 |
| TRIGger:I2C:DRNack..... | 672 |
| TRIGger:I2C:DWNack..... | 673 |

TRIGger:I2C:TYPE <Type>

Selects the trigger type for I²C analysis.

Parameters:

<Type>

START | REPStart | STOP | NACK | ADDRess | DATA | ADAT

START

Start condition

REPStart

Repeated start - the start condition occurs without previous stop condition.

STOP

Stop condition, end of frame

NACK

Missing acknowledge bit. To localize specific missing acknowledge bits, use:

TRIGger:I2C:ADNack

TRIGger:I2C:DWNack

TRIGger:I2C:DRNack

ADDRess

Triggers on one specific address

DATA

Triggers on a specific data

ADAT

Triggers on a combination of address and data condition.

*RST: START

Usage:

Asynchronous command

Manual operation:

See "Type" on page 317

TRIGger:I2C:ACCess <RWBitAddress>

Toggles the trigger condition between read and write access of the primary. Select "Either" if the transfer direction is not relevant for the trigger condition.

Parameters:

<RWBitAddress>

READ | WRITe | EITHer

*RST: EITHer

Usage: Asynchronous command
Manual operation: See "[R/W bit](#)" on page 319

TRIGger:I2C:ACONdition <AddrOptor>

Sets the operator to set a specific address or an address range. The address values are set with [TRIGger:I2C:ADDRes](#)s and [TRIGger:I2C:ADDTo](#).

Parameters:

<AddrOptor> EQUal | NEQUal | LTHan | LETHan | GTHan | GETHan |
 INRange | OORange
 *RST: EQUal

Usage: Asynchronous command

TRIGger:I2C:ADDRes <Address>

Triggers on the specified address, or sets the start value of an address range depending on the condition set with [TRIGger:I2C:ACONdition](#).

Parameters:

<Address> List of comma-separated values

Usage: Asynchronous command

Manual operation: See "[Address](#)" on page 319

TRIGger:I2C:ADDTo <AddressTo>

Sets the end value of an address range if the condition is set to an address range with [TRIGger:I2C:ACONdition](#).

Parameters:

<AddressTo> List of comma-separated values

Usage: Asynchronous command

Manual operation: See "[Address](#)" on page 319

TRIGger:I2C:ADNack <AddressNack>

Triggers if the address acknowledge bit is missing - no target recognizes the address.

Parameters:

<AddressNack> ON | OFF
 *RST: ON

Usage: Asynchronous command

Manual operation: See "[No Ack conditions](#)" on page 319

TRIGger:I2C:AMODe <AddressType>

Sets the address length to be triggered on: 7 bit or 10 bit.

Parameters:

<AddressType> BIT7 | BIT10
*RST: BIT7

Usage: Asynchronous command

Manual operation: See "[Address type](#)" on page 319

TRIGger:I2C:DCONDition <DataOperator>

Sets the operator to set a specific data value or a data range.

Parameters:

<DataOperator> EQUal | NEQual | LTHan | LETHan | GTHan | GETHan
*RST: EQUal

Usage: Asynchronous command

Manual operation: See "[Data](#)" on page 320

TRIGger:I2C:DMIN <Data>

Specifies the data bit pattern, or sets the start value of a data pattern range. Enter the bytes in MSB first bit order. The maximum pattern length is 64 bit. Waveform data is compared with the pattern byte-by-byte.

Parameters:

<Data>

Usage: Asynchronous command

Manual operation: See "[Data](#)" on page 320

TRIGger:I2C:DPOSition <DataPosition>

Sets the number of data bytes to be skipped after the address.

Parameters:

<DataPosition> Range: 1 to 4096
 Increment: 1
*RST: 1

Usage: Asynchronous command

Manual operation: See "[Position](#)" on page 320

TRIGger:I2C:DRNack <DataReadNack>

Triggers on the end of the read process when the controller reads data from the target. This NACK is sent according to the protocol definition, it is not an error.

Parameters:

<DataReadNack> ON | OFF
 *RST: ON

Usage: Asynchronous command

Manual operation: See "[No Ack conditions](#)" on page 319

TRIGger:I2C:DWNack <DataWriteNack>

Triggers if a data acknowledge bit is missing - the addressed target does not accept the data.

Parameters:

<DataWriteNack> ON | OFF
 *RST: ON

Usage: Asynchronous command

Manual operation: See "[No Ack conditions](#)" on page 319

17.16.3.3 Filter

There are two commands for each parameter, that you can use for defining the I2C settings.

For example, to set the *Frame type =WRITE > Field =Address >Data* value you can use one of the following commands:

- SBUS:I2C:FILTer:FRAMe1:FLD1:DMIN 01100
 Defines the parameter by using the index <m> for the frame number and <n> for the field number.
- SBUS:I2C:FILTer:DMIN "WRITe", "Address", 01100
 Defines the parameter by using the frame and field name.

| | |
|--|-----|
| SBUS<sb>:I2C:FILTer:ENABLE..... | 674 |
| SBUS<sb>:I2C:FILTer:FRENable..... | 674 |
| SBUS<sb>:I2C:FILTer:FRAMe<fr>:ENABLE..... | 674 |
| SBUS<sb>:I2C:FILTer:DMAX..... | 674 |
| SBUS<sb>:I2C:FILTer:FRAMe<fr>:FLD<fl>:DMAX..... | 674 |
| SBUS<sb>:I2C:FILTer:DMIN..... | 675 |
| SBUS<sb>:I2C:FILTer:FRAMe<fr>:FLD<fl>:DMIN..... | 675 |
| SBUS<sb>:I2C:FILTer:DOPerator..... | 675 |
| SBUS<sb>:I2C:FILTer:FRAMe<fr>:FLD<fl>:DOPerator..... | 675 |
| SBUS<sb>:I2C:FILTer:ERENable..... | 675 |
| SBUS<sb>:I2C:FILTer:ERRor<n>:ENABLE..... | 675 |
| SBUS<sb>:I2C:FILTer:IMAX..... | 676 |
| SBUS<sb>:I2C:FILTer:FRAMe<fr>:FLD<fl>:IMAX..... | 676 |
| SBUS<sb>:I2C:FILTer:IMIN..... | 676 |
| SBUS<sb>:I2C:FILTer:FRAMe<fr>:FLD<fl>:IMIN..... | 676 |
| SBUS<sb>:I2C:FILTer:IOPerator..... | 676 |
| SBUS<sb>:I2C:FILTer:FRAMe<fr>:FLD<fl>:IOPerator..... | 676 |

| | |
|---|-----|
| SBUS<sb>:I2C:FILTer:BIT..... | 677 |
| SBUS<sb>:I2C:FILTer:FRAMe<fr>:FLD<fl>:BIT..... | 677 |
| SBUS<sb>:I2C:FILTer:FIENable..... | 677 |
| SBUS<sb>:I2C:FILTer:FRAMe<fr>:FLD<fl>:ENABle..... | 677 |

SBUS<sb>:I2C:FILTer:ENABle <Enable>

Enables the filtering on I2C frames. Only the frames that match the selected filter conditions are displayed.

Suffix:

<sb> 1...4, index of the serial bus

Parameters:

<Enable> ON | OFF
*RST: ON

Usage: Asynchronous command

SBUS<sb>:I2C:FILTer:FRENable <Frame>,<Enabler>
SBUS<sb>:I2C:FILTer:FRAMe<fr>:ENABle <Enable>

Enables or disables the specific frame to be filtered on.

Suffix:

<sb> 1...4, index of the serial bus

<fr> index of the frame

Parameters:

<Enable> ON | OFF
*RST: ON

Usage: Asynchronous command

Manual operation: See "[Frame type](#)" on page 315

SBUS<sb>:I2C:FILTer:DMAx <Frame>,<Field>,<Data>
SBUS<sb>:I2C:FILTer:FRAMe<fr>:FLD<fl>:DMAx <Data_Max>

Sets the end value of a data pattern range if the operator is set to INRange or OORANGE.

Suffix:

<sb> 1...4, index of the serial bus

<fr> index of the frame

<fl> index of the field

Parameters:

<Data_Max>

Usage: Asynchronous command

Manual operation: See "[Edit](#)" on page 315

SBUS<sb>:I2C:FILTer:DMIN <Frame>,<Field>,<Data>

SBUS<sb>:I2C:FILTer:FRAMe<fr>:FLD<fl>:DMIN <Data_Min>

Specifies the data pattern, or sets the start value of a data pattern range.

Suffix:

<sb> 1...4, index of the serial bus

<fr> index of the frame

<fl> index of the field

Parameters:

<Data_Min>

Usage: Asynchronous command

Manual operation: See ["Edit"](#) on page 315

SBUS<sb>:I2C:FILTer:DOPerator <Frame>,<Field>,<Operator>

SBUS<sb>:I2C:FILTer:FRAMe<fr>:FLD<fl>:DOPerator <Data_Operator>

Sets the operator for the data pattern in the selected field of the selected frame.

Suffix:

<sb> 1...4, index of the serial bus

<fr> index of the frame

<fl> index of the field

Parameters:

<Data_Operator> EQUal | NEQUal | LTHan | LETHan | GTHan | GETHan |
INRange | OORange
*RST: EQUal

Usage: Asynchronous command

Manual operation: See ["Edit"](#) on page 315

SBUS<sb>:I2C:FILTer:ERENable <ErrorName>,<Enabler>

SBUS<sb>:I2C:FILTer:ERRor<n>:ENABle <Enable>

Defines the error type to be filtered on.

Suffix:

<sb> 1...4, index of the serial bus

<n> index of the error

Parameters:

<Enable> ON | OFF
*RST: ON

Usage: Asynchronous command

Manual operation: See ["Error type"](#) on page 316

SBUS<sb>:I2C:FILTer:IMAX <Frame>,<Field>,<Data>

SBUS<sb>:I2C:FILTer:FRAMe<fr>:FLD<fl>:IMAX <Index_Max>

Sets the end value of an index range if the operator is set to `INRange`.

Suffix:

<sb> 1...4, index of the serial bus

<fr> index of the frame

<fl> index of the field

Parameters:

<Index_Max> Range: 1 to 65535

Increment: 1

*RST: 65535

Usage: Asynchronous command

Manual operation: See ["Edit"](#) on page 315

SBUS<sb>:I2C:FILTer:IMIN <Frame>,<Field>,<Data>

SBUS<sb>:I2C:FILTer:FRAMe<fr>:FLD<fl>:IMIN <Index_Min>

Specifies the index, or sets the start value of an index range.

Suffix:

<sb> 1...4, index of the serial bus

<fr> index of the frame

<fl> index of the field

Parameters:

<Index_Min> Range: 1 to 65535

Increment: 1

*RST: 1

Usage: Asynchronous command

Manual operation: See ["Edit"](#) on page 315

SBUS<sb>:I2C:FILTer:IOPerator <Frame>,<Field>,<Operator>

SBUS<sb>:I2C:FILTer:FRAMe<fr>:FLD<fl>:IOPerator <Index_Operator>

Sets the operator for the index in the selected field of the selected frame.

Suffix:

<sb> 1...4, index of the serial bus

<fr> index of the frame

<fl> index of the field

Parameters:

<Index_Operator> EQUAL | INRange | RANGE

*RST: INRange

Usage: Asynchronous command

Manual operation: See "Edit" on page 315

SBUS<sb>:I2C:FILTer:BIT <Frame>,<Field>,<Bit>

SBUS<sb>:I2C:FILTer:FRAMe<fr>:FLD<fl>:BIT <BitState>

Sets the bit state of a field that only consists of one bit.

Suffix:

<sb> 1...4, index of the serial bus

<fr> index of the frame

<fl> index of the field

Parameters:

<BitState> ONE | ZERO

*RST: ZERO

Usage: Asynchronous command

Manual operation: See "Edit" on page 315

SBUS<sb>:I2C:FILTer:FIENable <Frame>,<Field>,<Enabler>

SBUS<sb>:I2C:FILTer:FRAMe<fr>:FLD<fl>:ENABLE <CondEnabler>

Enables or disables the checking condition for the selected field of the selected frame.

Suffix:

<sb> 1...4, index of the serial bus

<fr> index of the frame

<fl> index of the field

Parameters:

<CondEnabler> ON | OFF

*RST: OFF

Usage: Asynchronous command

Manual operation: See "Edit" on page 315

17.16.3.4 Decode results

| | |
|-----------------------------------|-----|
| SBUS<sb>:I2C:FCOunt? | 678 |
| SBUS<sb>:I2C:FRAMe<fr>:AACcess? | 678 |
| SBUS<sb>:I2C:FRAMe<fr>:ACCess? | 678 |
| SBUS<sb>:I2C:FRAMe<fr>:ACOMplete? | 679 |
| SBUS<sb>:I2C:FRAMe<fr>:ADBStart? | 679 |
| SBUS<sb>:I2C:FRAMe<fr>:ADDRess? | 679 |
| SBUS<sb>:I2C:FRAMe<fr>:ADEVice? | 680 |
| SBUS<sb>:I2C:FRAMe<fr>:AMODE? | 680 |
| SBUS<sb>:I2C:FRAMe<fr>:ASTart? | 680 |

| | |
|---|-----|
| SBUS<sb>:I2C:FRAMe<fr>:BCOunt?..... | 681 |
| SBUS<sb>:I2C:FRAMe<fr>:BITRate?..... | 681 |
| SBUS<sb>:I2C:FRAMe<fr>:BYTE<o>:ACCess?..... | 681 |
| SBUS<sb>:I2C:FRAMe<fr>:BYTE<o>:ACKStart?..... | 682 |
| SBUS<sb>:I2C:FRAMe<fr>:BYTE<o>:COMPLete?..... | 682 |
| SBUS<sb>:I2C:FRAMe<fr>:BYTE<o>:STARt?..... | 682 |
| SBUS<sb>:I2C:FRAMe<fr>:BYTE<o>:VALue?..... | 683 |
| SBUS<sb>:I2C:FRAMe<fr>:DATA?..... | 683 |
| SBUS<sb>:I2C:FRAMe<fr>:RWBStart?..... | 683 |
| SBUS<sb>:I2C:FRAMe<fr>:STARt?..... | 684 |
| SBUS<sb>:I2C:FRAMe<fr>:STATus?..... | 684 |
| SBUS<sb>:I2C:FRAMe<fr>:STOP?..... | 685 |
| SBUS<sb>:I2C:FRAMe<fr>:SYMBol?..... | 685 |

SBUS<sb>:I2C:FCOunt?

Returns the number of decoded frames.

Suffix:

<sb> 1..4
 Selects the serial bus.

Return values:

<Count> Total number of decoded frames.

Usage:

Query only
Asynchronous command

SBUS<sb>:I2C:FRAMe<fr>:AACCCess?

Returns the address acknowledge bit value for the indicated frame.

Suffix:

<sb> 1...4, index of the serial bus
<fr> index of the frame

Return values:

<AddressAckBit> ACK | NACK | EITHer
 *RST: EITHer

Usage:

Query only
Asynchronous command

SBUS<sb>:I2C:FRAMe<fr>:ACCess?

Returns the value of the R/W bit of the indicated frame.

Suffix:

<sb> 1...4, index of the serial bus
<fr> index of the frame

Return values:

<RWBit> UNDeFined | READ | WRITe | EITHer
 *RST: UNDeFined

Usage:

Query only
 Asynchronous command

SBUS<sb>:I2C:FRAMe<fr>:ACOMplete?

Returns if the address is completely contained in the acquisition.

Suffix:

<sb> 1...4, index of the serial bus
 <fr> index of the frame

Return values:

<AddrComplete> ON | OFF
 *RST: OFF

Usage:

Query only
 Asynchronous command

SBUS<sb>:I2C:FRAMe<fr>:ADBStart?

Returns the start time of the address acknowledge bit.

Suffix:

<sb> 1...4, index of the serial bus
 <fr> index of the frame

Return values:

<AddrAckBtStrt> Range: -1E+26 to 1E+26
 Increment: 1E-10
 *RST: 0
 Default unit: s

Usage:

Query only
 Asynchronous command

SBUS<sb>:I2C:FRAMe<fr>:ADDRess?

Returns the device address value of the indicated frame. That is, the address value that is shown in the decoded cells and in the decode results table.

Suffix:

<sb> 1...4, index of the serial bus
 <fr> index of the frame

Return values:

<AddressValue> Range: 0 to 2047
 Increment: 1
 *RST: 0

Usage:

Query only
 Asynchronous command

SBUS<sb>:I2C:FRAMe<fr>:ADEVice?

Returns the pure device address of the indicated frame *without* the R/W bit.

Suffix:

<sb> 1...4, index of the serial bus
 <fr> index of the frame

Return values:

<DeviceAddress> Range: 0 to 1023
 Increment: 1
 *RST: 0

Usage:

Query only
 Asynchronous command

SBUS<sb>:I2C:FRAMe<fr>:AMODe?

Returns the address length.

Suffix:

<sb> 1...4, index of the serial bus
 <fr> index of the frame

Return values:

<AddressType> BIT7 | BIT7RW | BIT7_RW | BIT10 | AUTO | ANY
 *RST: BIT7

Usage:

Query only
 Asynchronous command

SBUS<sb>:I2C:FRAMe<fr>:ASStart?

Returns the start time of the address for the indicated frame.

Suffix:

<sb> 1...4, index of the serial bus
 <fr> index of the frame

Return values:

<AddressStart> Range: -1E+26 to 1E+26
 Increment: 1E-10
 *RST: 0
 Default unit: s

Usage:

Query only
 Asynchronous command

SBUS<sb>:I2C:FRAMe<fr>:BCOunt?

Returns the number of bytes in the specified frame.

Suffix:

<sb> 1...4, index of the serial bus
 <fr> index of the frame

Return values:

<Count>

Usage:

Query only
 Asynchronous command

SBUS<sb>:I2C:FRAMe<fr>:BITRate?

Returns the primary bit rate.

Suffix:

<sb> 1...4, index of the serial bus
 <fr> index of the frame

Return values:

<PrimaryBitRate> Range: 0 to 100000000000
 Increment: 1
 *RST: 0
 Default unit: bps

Usage:

Query only
 Asynchronous command

SBUS<sb>:I2C:FRAMe<fr>:BYTE<o>:ACCess?

Returns the acknowledge bit value of the specified data byte.

Suffix:

<sb> 1...4, index of the serial bus
 <fr> index of the frame
 <o> index of the byte number

Return values:

<AckBit> ACK | NACK | EITHer
 *RST: EITHer

Usage:

Query only
 Asynchronous command

SBUS<sb>:I2C:FRAMe<fr>:BYTE<o>:ACKStart?

Returns the start time of the acknowledge bit of the specified byte.

Suffix:

<sb> 1...4, index of the serial bus
 <fr> index of the frame
 <o> index of the byte number

Return values:

<AckBitStart> Range: -1E+26 to 1E+26
 Increment: 1E-10
 *RST: 0
 Default unit: s

Usage:

Query only
 Asynchronous command

SBUS<sb>:I2C:FRAMe<fr>:BYTE<o>:COMPLete?

Returns if the indicated byte is completely contained in the acquisition.

Suffix:

<sb> 1...4, index of the serial bus
 <fr> index of the frame
 <o> index of the byte number

Return values:

<ValueComplete> ON | OFF
 *RST: OFF

Usage:

Query only
 Asynchronous command

SBUS<sb>:I2C:FRAMe<fr>:BYTE<o>:STARt?

Returns the start time of the specified data byte.

Suffix:

<sb> 1...4, index of the serial bus
 <fr> index of the frame
 <o> index of the byte number

Return values:

<FrameByteStart> Range: -1E+26 to 1E+26
 Increment: 1E-10
 *RST: 0
 Default unit: s

Usage:

Query only
 Asynchronous command

SBUS<sb>:I2C:FRAMe<fr>:BYTE<o>:VALue?

Returns the data value of the specified byte.

Suffix:

<sb> 1...4, index of the serial bus
 <fr> index of the frame
 <o> index of the byte number

Return values:

<Value> Range: 0 to 255
 Increment: 1
 *RST: 0

Usage:

Query only
 Asynchronous command

SBUS<sb>:I2C:FRAMe<fr>:DATA?

Returns the data words of the specified frame.

Suffix:

<sb> 1...4, index of the serial bus
 <fr> index of the frame

Example:

```
BUS:I2C:FRAMe4:DATA?
<-- 3,74,164,18
```

Usage:

Query only
 Asynchronous command

SBUS<sb>:I2C:FRAMe<fr>:RWBStart?

Returns the start time of the R/W bit

Suffix:

<sb> 1...4, index of the serial bus
 <fr> index of the frame

Return values:

<RWBitStart> Range: -1E+26 to 1E+26
 Increment: 1E-10
 *RST: 0
 Default unit: s

Usage:

Query only
 Asynchronous command

SBUS<sb>:I2C:FRAMe<fr>:START?

Returns the start time of the specified frame.

Suffix:

<sb> 1...4, index of the serial bus
 <fr> index of the frame

Return values:

<FrameStart> Range: -1E+26 to 1E+26
 Increment: 1E-10
 *RST: 0
 Default unit: s

Usage:

Query only
 Asynchronous command

SBUS<sb>:I2C:FRAMe<fr>:STATUs?

Returns the overall state of the frame.

Suffix:

<sb> 1...4, index of the serial bus
 <fr> index of the frame

Return values:

<FrameState> NOSTop | OK | INComplete | ADDifferent | UNKNown

INComplete

The stop bit is missing.

OK

The frame is valid.

UNEXpstop

A stop bit was detected but clock and data are continued.

INSufficient

The frame is not completely contained in the acquisition. The acquired part of the frame is valid.

ADDifferent

Error in 10-bit address. For a read access on a 10-bit address, the first address byte is sent twice, first as write, the second as read. The first 7 bits of the byte must be identical. If they are not identical, the ADDifferent error is indicated.

*RST: OK

Usage: Query only
Asynchronous command

SBUS<sb>:I2C:FRAMe<fr>:STOP?

Returns the end time of the specified frame.

Suffix:

<sb> 1...4, index of the serial bus

<fr> index of the frame

Return values:

<FrameStop> Range: -1E+26 to 1E+26
Increment: 1E-10
*RST: 0
Default unit: s

Usage: Query only
Asynchronous command

SBUS<sb>:I2C:FRAMe<fr>:SYMBol?

Returns the symbolic label of the specified frame if the label list is enabled.

Suffix:

<sb> 1...4, index of the serial bus

<fr> index of the frame

Return values:

<Translation> String with symbolic name of the address

Usage: Query only
Asynchronous command

17.16.4 UART / RS-232 (option R&S MXO5-K510)

Before R&S MXO 5 can accept the specific bus commands, make sure that:

- The decoding of the specified bus is enabled with `SBUS<sb>[:STATe]`.
- The bus is set to the correct type with `SBUS<sb>:TYPE`.

| | |
|--|-----|
| • Configuration | 686 |
| • Trigger | 692 |
| • Filter | 693 |
| • Decode results | 697 |

17.16.4.1 Configuration

| | |
|----------------------------------|-----|
| SBUS<sb>:UART:BITRate..... | 686 |
| SBUS<sb>:UART:BORDER..... | 686 |
| SBUS<m>:UART:EWORd..... | 687 |
| SBUS<sb>:UART:PACKets..... | 687 |
| SBUS<sb>:UART:PARity..... | 687 |
| SBUS<sb>:UART:POLarity..... | 688 |
| SBUS<sb>:UART:RX:HYSTeresis..... | 688 |
| SBUS<sb>:UART:RX:SOURce..... | 688 |
| SBUS<sb>:UART:RX:THReshold..... | 689 |
| SBUS<sb>:UART:SBIT..... | 689 |
| SBUS<sb>:UART:SSIZE..... | 689 |
| SBUS<sb>:UART:TOUT..... | 690 |
| SBUS<sb>:UART:TX:HYSTeresis..... | 690 |
| SBUS<sb>:UART:TX:SOURce..... | 690 |
| SBUS<sb>:UART:TX:THReshold..... | 690 |
| SBUS<sb>:UART:RX:POSition..... | 691 |
| SBUS<sb>:UART:RX:SCALe..... | 691 |
| SBUS<sb>:UART:TX:POSition..... | 691 |
| SBUS<sb>:UART:TX:SCALe..... | 691 |

SBUS<sb>:UART:BITRate <Bitrate>

Sets the number of transmitted bits per second.

Suffix:

<sb> 1...4, index of the serial bus

Parameters:

<Bitrate> Range: 300 to 20000000
 Increment: 1
 *RST: 9600
 Default unit: bps

Usage: Asynchronous command

Manual operation: See "[Bit rate](#)" on page 329

SBUS<sb>:UART:BORDER <BitOrder>

Selects the bit order, which determines if the data of the messages starts with MSB (most significant bit) or LSB (least significant bit).

Suffix:

<sb> 1...4, index of the serial bus

Parameters:

<BitOrder> LSBF | MSBF
 *RST: LSBF

Usage: Asynchronous command

Manual operation: See ["Bit order"](#) on page 328

SBUS<m>:UART:EWORd <EndWord>

Sets the end pattern of the packets. A new packet starts with the first start bit after the defined end pattern.

The command is relevant if [SBUS<sb>:UART:PACKets](#) is set to EWORd.

Suffix:

<m> 1...4, index of the serial bus

Parameters:

<EndWord>

Usage: Asynchronous command

Manual operation: See ["Packets"](#) on page 329

SBUS<sb>:UART:PACKets <FrmSeparation>

Defines the method of packet separation. A packet is a number of subsequent words in a data stream.

Suffix:

<sb> 1...4, index of the serial bus

Parameters:

<FrmSeparation> NONE | TOUT

NONE

Packets are not considered.

EWORd

End word, the end condition of a packet is a pattern. To define the end word, use [SBUS<m>:UART:EWORd](#).

TOUT

Defines a timeout between the packets. To set the timeout, use [SBUS<sb>:UART:TOUT](#).

*RST: TOUT

Usage: Asynchronous command

Manual operation: See ["Packets"](#) on page 329

SBUS<sb>:UART:PARity <Parity>

Defines the optional parity bit that is used for error detection.

Suffix:

<sb> 1...4, index of the serial bus

Parameters:

<Parity> NONE | ODD | EVEN | MARK | SPC | DC

MARK

The parity bit is always a logic 1.

SPC

SPaCe: The parity bit is always a logic 0.

DC

Do not care: the parity is ignored.

*RST: NONE

Usage: Asynchronous command

Manual operation: See "[Parity](#)" on page 329

SBUS<sb>:UART:POLarity <Polarity>

Defines the logic levels of the bus. The idle state corresponds to a logic 1. The start bit corresponds to a logic 0. "Idle high" (high=1) is used, for example, for control signals, while "Idle low" (low=1) is defined for data lines (RS-232).

Suffix:

<sb> 1...4, index of the serial bus

Parameters:

<Polarity> IDLLow | IDLHigh

*RST: IDLHigh

Usage: Asynchronous command

Manual operation: See "[Polarity](#)" on page 329

SBUS<sb>:UART:RX:HYSteresis <Rx hysteresis>

Sets the hysteresis for the Tx line.

Suffix:

<sb> 1...4, index of the serial bus

Parameters:

<Rx hysteresis>

Usage: Asynchronous command

Manual operation: See "[Threshold](#)" on page 330

SBUS<sb>:UART:RX:SOURce RXSource

Selects the input channel for the receiver signal.

Suffix:

<sb> 1...4, index of the serial bus

Parameters:

RXSource C1 | C2 | C3 | C4 | C5 | C6 | C7 | C8 | D0 | D1 | D2 | D3 | D4 | D5
| D6 | D7 | D8 | D9 | D10 | D11 | D12 | D13 | D14 | D15 | M1 | M2
| M3 | M4 | M5 | M6 | M7 | M8 | R1 | R2 | R3 | R4 | R5 | R6 | R7 |
R8

Usage: Asynchronous command

Manual operation: See ["Source: Tx, Rx"](#) on page 328

SBUS<sb>:UART:RX:THReshold <Rx threshold>

Sets a user-defined threshold value for the Rx line.

Suffix:

<sb> 1...4, index of the serial bus

Parameters:

<Rx threshold>

Usage: Asynchronous command

Manual operation: See ["Threshold"](#) on page 330

SBUS<sb>:UART:SBIT <StopBits>

Sets the number of stop bits: 1 or 1.5 or 2 stop bits are possible.

Suffix:

<sb> 1...4, index of the serial bus

Parameters:

<StopBits> B1 | B15 | B2
*RST: B1

Usage: Asynchronous command

Manual operation: See ["Stop bits"](#) on page 329

SBUS<sb>:UART:SSIZe <DataBits>

Sets the number of data bits of a word in a range from 5 bits to 8 bits. If no parity bit is used, then 9 data bits are possible.

Suffix:

<sb> 1...4, index of the serial bus

Parameters:

<DataBits> Range: 5 to 9
Increment: 1
*RST: 8

Usage: Asynchronous command

Manual operation: See ["Data bits"](#) on page 329

SBUS<sb>:UART:TOUT <Timeout>

Sets the timeout between packets in a UART data stream. A new packet starts with the first start bit after the timeout.

The command is relevant if `SBUS<sb>:UART:PACKets` is set to TOUT.

Suffix:

<sb> 1...4, index of the serial bus

Parameters:

<Timeout> Range: 1E-06 to 1
Increment: 1
*RST: 0.000625
Default unit: s

Usage: Asynchronous command

Manual operation: See "[Packets](#)" on page 329

SBUS<sb>:UART:TX:HYSteresis <Tx hysteresis>

Sets the hysteresis for the TX line.

Suffix:

<sb> 1...4, index of the serial bus

Parameters:

<Tx hysteresis>

Usage: Asynchronous command

Manual operation: See "[Threshold](#)" on page 330

SBUS<sb>:UART:TX:SOURce TXSource

Selects the input channel for the transmitter signal.

Suffix:

<sb> 1...4, index of the serial bus

Parameters:

TXSource C1 | C2 | C3 | C4 | C5 | C6 | C7 | C8 | D0 | D1 | D2 | D3 | D4 | D5
| D6 | D7 | D8 | D9 | D10 | D11 | D12 | D13 | D14 | D15 | M1 | M2
| M3 | M4 | M5 | M6 | M7 | M8 | R1 | R2 | R3 | R4 | R5 | R6 | R7 |
R8

Usage: Asynchronous command

Manual operation: See "[Source: Tx, Rx](#)" on page 328

SBUS<sb>:UART:TX:THReshold <Tx threshold>

Sets a user-defined threshold value for the Tx line.

Suffix:
<sb> 1...4, index of the serial bus

Parameters:
<Tx threshold> User-defined clock threshold

Usage: Asynchronous command

Manual operation: See "[Threshold](#)" on page 330

SBUS<sb>:UART:RX:POSition <Rx position>

Sets the vertical position of the RX UART signal.

Suffix:
<sb> 1...4, index of the serial bus

Parameters:
<Rx position>

Usage: Asynchronous command

SBUS<sb>:UART:RX:SCALE <Rx scale>

Set the vertical scale of the RX UART signal.

Suffix:
<sb> 1...4, index of the serial bus

Parameters:
<Rx scale>

Usage: Asynchronous command

SBUS<sb>:UART:TX:POSition <Tx position>

Sets the vertical position of the TX UART signal.

Suffix:
<sb> 1...4, index of the serial bus

Parameters:
<Tx position>

Usage: Asynchronous command

SBUS<sb>:UART:TX:SCALE <Tx scale>

Set the vertical scale of the TX UART signal.

Suffix:
<sb> 1...4, index of the serial bus

Parameters:
<Tx scale>

Usage: Asynchronous command

17.16.4.2 Trigger

Trigger commands for serial buses affect the current trigger source. Therefore, set the trigger source to the required serial bus with `TRIGger:EVENT<ev>:SOURce` before sending the bus-specific trigger commands.

| | |
|--|-----|
| <code>TRIGger:UART:DATA</code> | 692 |
| <code>TRIGger:UART:DPOSition</code> | 692 |
| <code>TRIGger:UART:FCONDition</code> | 692 |
| <code>TRIGger:UART:OPERator</code> | 693 |
| <code>TRIGger:UART:SOURce</code> | 693 |
| <code>TRIGger:UART:TYPE</code> | 693 |

`TRIGger:UART:DATA` <DataPattern>

Specifies the data pattern to be found on the specified trigger source. Enter the words in MSB first bit order.

Parameters:

<DataPattern>

Usage: Asynchronous command

Manual operation: See "[Value](#)" on page 335

`TRIGger:UART:DPOSition` <DataPosition>

Sets the number of words before the first word of interest. These offset words are ignored.

Parameters:

<DataPosition> Range: 1 to 4096
 Increment: 1
 *RST: 1

Usage: Asynchronous command

Manual operation: See "[Position](#)" on page 335

`TRIGger:UART:FCONDition` <DataOperator>

Selects the operator for the "Data" pattern.

Parameters:

<DataOperator> EQUal | NEQual | LTHan | LETHan | GTHan | GETHan
 *RST: EQUal

Usage: Asynchronous command

Manual operation: See "[Data](#)" on page 334

TRIGger:UART:OPERator <DataOperator>

Sets the operator for the data pattern in the selected field of the selected frame.

Parameters:

<DataOperator> EQUal | NEQual | LTHan | LETHan | GTHan | GETHan
*RST: EQUal

Usage: Asynchronous command

TRIGger:UART:SOURce <Source>

Selects the transmitter or receiver line as trigger source.

Parameters:

<Source> TX | RX
*RST: TX

Usage: Asynchronous command

Manual operation: See "[Trigger source](#)" on page 334

TRIGger:UART:TYPE <Type>

Selects the trigger condition.

Parameters:

<Type> STBT | PCKS | DATA | PRER | BRKC | STPerror
STBT: Start bit
PCKS: Packet start
DATA: Serial pattern
BRKC: Break condition
STPerror: Stop error
*RST: STBT

Usage: Asynchronous command

Manual operation: See "[Type](#)" on page 334

17.16.4.3 Filter

| | |
|--|-----|
| SBUS<sb>:UART:FILTer:IMIN | 694 |
| SBUS<sb>:UART:FILTer:FRAMe<fr>:FLD<fl>:IMIN | 694 |
| SBUS<sb>:UART:FILTer:IMAX | 694 |
| SBUS<sb>:UART:FILTer:FRAMe<fr>:FLD<fl>:IMAX | 694 |
| SBUS<sb>:UART:FILTer:IOPerator | 695 |
| SBUS<sb>:UART:FILTer:FRAMe<fr>:FLD<fl>:IOPerator | 695 |
| SBUS<sb>:UART:FILTer:ERENable | 695 |
| SBUS<sb>:UART:FILTer:ERRor<n>:ENABle | 695 |
| SBUS<sb>:UART:FILTer:DOPerator | 695 |
| SBUS<sb>:UART:FILTer:FRAMe<fr>:FLD<fl>:DOPerator | 695 |

| | |
|--|-----|
| SBUS<sb>:UART:FILTer:DMIN..... | 696 |
| SBUS<sb>:UART:FILTer:FRAMe<fr>:FLD<fl>:DMIN..... | 696 |
| SBUS<sb>:UART:FILTer:DMAX..... | 696 |
| SBUS<sb>:UART:FILTer:FRAMe<fr>:FLD<fl>:DMAX..... | 696 |
| SBUS<sb>:UART:FILTer:BIT..... | 696 |
| SBUS<sb>:UART:FILTer:FRAMe<fr>:FLD<fl>:BIT..... | 696 |
| SBUS<sb>:UART:FILTer:FRENable..... | 697 |
| SBUS<sb>:UART:FILTer:FRAMe<fr>:ENABLE..... | 697 |
| SBUS<sb>:UART:FILTer:FIENable..... | 697 |
| SBUS<sb>:UART:FILTer:FRAMe<fr>:FLD<fl>:ENABLE..... | 697 |

SBUS<sb>:UART:FILTer:IMIN <Frame>,<Field>,<Data>
SBUS<sb>:UART:FILTer:FRAMe<fr>:FLD<fl>:IMIN <Index_Min>

Specifies the index, or sets the start value of an index range.

Suffix:

| | |
|------|--------------------------------|
| <sb> | 1...4, index of the serial bus |
| <fr> | index of the frame |
| <fl> | index of the field |

Parameters:

| | |
|-------------|-------------------|
| <Index_Min> | Range: 1 to 65535 |
| | Increment: 1 |
| | *RST: 1 |

Usage: Asynchronous command

Manual operation: See "Edit" on page 332

SBUS<sb>:UART:FILTer:IMAX <Frame>,<Field>,<Data>
SBUS<sb>:UART:FILTer:FRAMe<fr>:FLD<fl>:IMAX <Index_Max>

Sets the end value of an index range if the operator is set to INRange.

Suffix:

| | |
|------|--------------------------------|
| <sb> | 1...4, index of the serial bus |
| <fr> | index of the frame |
| <fl> | index of the field |

Parameters:

| | |
|-------------|-------------------|
| <Index_Max> | Range: 1 to 65535 |
| | Increment: 1 |
| | *RST: 65535 |

Usage: Asynchronous command

Manual operation: See "Edit" on page 332

SBUS<sb>:UART:FILTer:IOPerator <Frame>,<Field>,<Operator>
SBUS<sb>:UART:FILTer:FRAMe<fr>:FLD<fl>:IOPerator <Index_Operator>

Sets the operator for the index in the selected field of the selected frame.

Suffix:

<sb> 1...4, index of the serial bus
 <fr> index of the frame
 <fl> index of the field

Parameters:

<Index_Operator> EQUal | INRange | RANGe
 *RST: INRange

Usage: Asynchronous command

Manual operation: See ["Edit"](#) on page 332

SBUS<sb>:UART:FILTer:ERENable <ErrorName>,<Enabler>

SBUS<sb>:UART:FILTer:ERRor<n>:ENABLE <Enable>

Defines the error type to be filtered on.

Suffix:

<sb> 1...4, index of the serial bus
 <n> index of the error

Parameters:

<Enable> ON | OFF
 *RST: ON

Usage: Asynchronous command

Manual operation: See ["Error type"](#) on page 333

SBUS<sb>:UART:FILTer:DOPerator <Frame>,<Field>,<Operator>

SBUS<sb>:UART:FILTer:FRAMe<fr>:FLD<fl>:DOPerator <Data_Operator>

Sets the operator for the data pattern in the selected field of the selected frame.

Suffix:

<sb> 1...4, index of the serial bus
 <fr> index of the frame
 <fl> index of the field

Parameters:

<Data_Operator> EQUal | NEQUal | LTHan | LETHan | GTHan | GETHan |
 INRange | OORange
 *RST: EQUal

Usage: Asynchronous command

Manual operation: See "Edit" on page 332

SBUS<sb>:UART:FILTer:DMIN <Frame>,<Field>,<Data>
SBUS<sb>:UART:FILTer:FRAMe<fr>:FLD<fl>:DMIN <Data_Min>

Specifies the data pattern, or sets the start value of a data pattern range.

Suffix:

| | |
|------|---|
| <sb> | 1..4
Selects the serial bus. |
| <fr> | *
Specifies the frame number. |
| <fl> | *
Specifies the field number within the frame. |

Parameters:

<Data_Min>

Usage: Asynchronous command

Manual operation: See "Edit" on page 332

SBUS<sb>:UART:FILTer:DMAX <Frame>,<Field>,<Data>
SBUS<sb>:UART:FILTer:FRAMe<fr>:FLD<fl>:DMAX <Data_Max>

Sets the end value of a data pattern range if the operator is set to INRange or OORANGE.

Suffix:

| | |
|------|--------------------------------|
| <sb> | 1...4, index of the serial bus |
| <fr> | index of the frame |
| <fl> | index of the field |

Parameters:

<Data_Max>

Usage: Asynchronous command

Manual operation: See "Edit" on page 332

SBUS<sb>:UART:FILTer:BIT <Frame>,<Field>,<Bit>
SBUS<sb>:UART:FILTer:FRAMe<fr>:FLD<fl>:BIT <BitState>

Sets the bit state of a field that only consists of one bit.

Suffix:

| | |
|------|--------------------------------|
| <sb> | 1...4, index of the serial bus |
| <fr> | index of the frame |
| <fl> | index of the field |

Parameters:

<BitState> ONE | ZERO
 *RST: ZERO

Usage: Asynchronous command

Manual operation: See ["Edit"](#) on page 332

SBUS<sb>:UART:FILTer:FREnable <Frame>,<Enabler>

SBUS<sb>:UART:FILTer:FRAME<fr>:ENABLE <Enable>

Enables or disables the checking condition for the selected frame.

Suffix:

<sb> 1...4, index of the serial bus
 <fr> index of the frame

Parameters:

<Enable> ON | OFF
 *RST: ON

Usage: Asynchronous command

Manual operation: See ["Frame type"](#) on page 331

SBUS<sb>:UART:FILTer:FIENable <Frame>,<Field>,<Enabler>

SBUS<sb>:UART:FILTer:FRAME<fr>:FLD<fl>:ENABLE <CondEnabler>

Enables or disables the checking condition for the selected field of the selected frame.

Suffix:

<sb> 1...4, index of the serial bus
 <fr> index of the frame
 <fl> index of the field

Parameters:

<CondEnabler> ON | OFF
 *RST: OFF

Usage: Asynchronous command

Manual operation: See ["Edit"](#) on page 332

17.16.4.4 Decode results

| | |
|--|-----|
| SBUS<sb>:UART:WORD<w>:BITRate? | 698 |
| SBUS<sb>:UART:WORD<w>:COUNT? | 698 |
| SBUS<sb>:UART:WORD<w>:RXValue? | 698 |
| SBUS<sb>:UART:WORD<w>:SOURce? | 699 |
| SBUS<sb>:UART:WORD<w>:STARt? | 699 |

| | |
|-------------------------------------|-----|
| SBUS<sb>:UART:WORD<w>:STOP?..... | 699 |
| SBUS<sb>:UART:WORD<w>:STATe?..... | 700 |
| SBUS<sb>:UART:WORD<w>:TXValue?..... | 700 |

SBUS<sb>:UART:WORD<w>:BITRate?

Returns the primary bit rate.

Suffix:

| | |
|------|--------------------------------|
| <sb> | 1...4, index of the serial bus |
| <w> | index of the word |

Return values:

| | |
|------------------|--------------------------|
| <PrimaryBitRate> | Range: 0 to 100000000000 |
| | Increment: 1 |
| | *RST: 0 |
| | Default unit: bps |

Usage:

Query only
Asynchronous command

SBUS<sb>:UART:WORD<w>:COUNT?

Returns the number of words in the acquisition.

Suffix:

| | |
|------|--------------------------------|
| <sb> | 1...4, index of the serial bus |
| <w> | * |
| | The suffix is irrelevant. |

Return values:

| | |
|---------|-----------------|
| <Count> | Number of words |
|---------|-----------------|

Usage:

Query only
Asynchronous command

SBUS<sb>:UART:WORD<w>:RXValue?

Returns the value of the specified word on the Rx line.

Suffix:

| | |
|------|--------------------------------|
| <sb> | 1...4, index of the serial bus |
| <w> | index of the word |

Return values:

| | |
|-----------|-----------------|
| <RxValue> | Range: 0 to 511 |
| | Increment: 1 |
| | *RST: 0 |

Usage:

Query only
Asynchronous command

SBUS<sb>:UART:WORD<w>:SOURce?

Returns the line on which the specified word was transferred.

Suffix:

<sb> 1...4, index of the serial bus

<w> index of the word

Return values:

<WordSource> TX | RX
*RST: TX

Usage: Query only
Asynchronous command

SBUS<sb>:UART:WORD<w>:START?

Returns the start time of the specified word.

Suffix:

<sb> 1...4, index of the serial bus

<w> index of the word

Return values:

<WordStart> Range: -1E+26 to 1E+26
Increment: 1E-10
*RST: 0
Default unit: s

Usage: Query only
Asynchronous command

SBUS<sb>:UART:WORD<w>:STOP?

Returns the stop time of the specified word.

Suffix:

<sb> 1...4, index of the serial bus

<w> index of the word

Return values:

<WordStop> Range: -1E+26 to 1E+26
Increment: 1E-10
*RST: 0
Default unit: s

Usage: Query only
Asynchronous command

SBUS<sb>:UART:WORD<w>:STATe?

Returns the status of the specified word.

Suffix:

<sb> 1...4, index of the serial bus
 <w> index of the word

Return values:

<WordState> OK | BREak | STERror | SPERror | PRERror | INComplete
 OK: the frame is valid.
 BREak: stop bit error with 0x00 word
 STERror: start error, incorrect start bit
 SPERror: stop error, incorrect stop bit
 PRERror: parity error, incorrect parity bit.
 INComplete: The frame is not completely contained in the acquisition. The acquired part of the frame is valid.
 *RST: OK

Usage: Query only
 Asynchronous command

SBUS<sb>:UART:WORD<w>:TXValue?

Returns the value of the specified word on the TX line.

Suffix:

<sb> 1...4, index of the serial bus
 <w> index of the word

Return values:

<TxValue> Range: 0 to 511
 Increment: 1
 *RST: 0

Usage: Query only
 Asynchronous command

17.16.5 CAN (option R&S MXO5-K520)

Before R&S MXO 5 can accept the specific bus commands, make sure that:

- The decoding of the specified bus is enabled with `SBUS<sb>[:STATe]`.
- The bus is set to the correct type with `SBUS<sb>:TYPE`.

| | |
|--|-----|
| • Configuration | 701 |
| • Trigger | 706 |
| • Filter | 715 |
| • Decode results | 719 |

17.16.5.1 Configuration

| | |
|-------------------------------------|-----|
| SBUS<sb>:CAN:TYPE..... | 701 |
| SBUS<sb>:CAN:BITRate..... | 701 |
| SBUS<sb>:CAN:SAMPlepoint..... | 702 |
| SBUS<sb>:CAN:SOURce..... | 702 |
| SBUS<sb>:CAN:FDATa:DBITrate..... | 702 |
| SBUS<sb>:CAN:FDATa:SAMPlepoint..... | 702 |
| SBUS<sb>:CAN:SIC:HYSteresis..... | 703 |
| SBUS<sb>:CAN:SIC:THReshold..... | 703 |
| SBUS<sb>:CAN:FAST:THReshold..... | 703 |
| SBUS<sb>:CAN:FAST:HYSteresis..... | 704 |
| SBUS<sb>:CAN:XDATa:DBITrate..... | 704 |
| SBUS<sb>:CAN:XDATa:SAMPlepoint..... | 704 |
| SBUS<sb>:CAN:TRCVmode..... | 704 |
| SBUS<sb>:CAN:SYMBols..... | 705 |
| SBUS<sb>:CAN:NEWLlist..... | 705 |
| SBUS<sb>:CAN:POSition..... | 705 |
| SBUS<sb>:CAN:SCALE..... | 706 |

SBUS<sb>:CAN:TYPE <SignalType>

Selects the CAN-High or CAN-Low line. Both lines are required for differential signal transmission used by CAN.

Suffix:

<sb> 1...4, index of the serial bus

Parameters:

<SignalType> CANL | CANH
*RST: CANL

Usage: Asynchronous command

Manual operation: See "[Type](#)" on page 342

SBUS<sb>:CAN:BITRate <Bitrate>

Sets the number of transmitted bits per second.

Suffix:

<sb> 1...4, index of the serial bus

Parameters:

<Bitrate> Range: 10000 to 5000000
Increment: 100
*RST: 100000
Default unit: bps

Usage: Asynchronous command

Manual operation: See "[Nominal bit rate](#)" on page 342

SBUS<sb>:CAN:SAMPlEpoint <SamplePoint>

Sets the position of the sample point within the bit in percent of the nominal bit time.

Suffix:

<sb> 1...4, index of the serial bus

Parameters:

<SamplePoint> Range: 30 to 90
Increment: 5
*RST: 66
Default unit: %

Usage: Asynchronous command

Manual operation: See "[Sample point](#)" on page 342

SBUS<sb>:CAN:SOURce Source

Sets the source channel to which the line is connected.

Suffix:

<sb> 1...4, index of the serial bus

Parameters:

Source C1 | C2 | C3 | C4 | C5 | C6 | C7 | C8 | D0 | D1 | D2 | D3 | D4 | D5
| D6 | D7 | D8 | D9 | D10 | D11 | D12 | D13 | D14 | D15 | M1 | M2
| M3 | M4 | M5 | M6 | M7 | M8 | R1 | R2 | R3 | R4 | R5 | R6 | R7 |
R8

Usage: Asynchronous command

Manual operation: See "[Data](#)" on page 341

SBUS<sb>:CAN:FDATa:DBITrate <FDBitrate>

Sets the bit rate of the data phase.

Suffix:

<sb> 1...4, index of the serial bus

Parameters:

<FDBitrate> Range: 10000 to 15000000
Increment: 100
*RST: 1000000
Default unit: bps

Usage: Asynchronous command

Manual operation: See "[FD bit rate](#)" on page 342

SBUS<sb>:CAN:FDATa:SAMPlEpoint <FDSamplePoint>

Sets the position of the sample point within the bit in percent of the nominal bit time.

Suffix:

<sb> 1...4, index of the serial bus

Parameters:

<FDSamplePoint> Range: 30 to 90
 Increment: 5
 *RST: 66
 Default unit: %

Usage:

Asynchronous command

Manual operation: See "[FD sample point](#)" on page 342

SBUS<sb>:CAN:SIC:HYSTeresis <Hysteresis>

Sets a hysteresis value for the SIC transceiver mode.

Suffix:

<sb> 1...4, index of the serial bus

Parameters:

<Hysteresis>

Usage:

Asynchronous command

Manual operation: See "[Threshold](#)" on page 343

SBUS<sb>:CAN:SIC:THReshold <SIC Threshold>

Sets a threshold value for the SIC transceiver mode.

Suffix:

<sb> 1...4, index of the serial bus

Parameters:

<SIC Threshold>

Usage:

Asynchronous command

Manual operation: See "[Threshold](#)" on page 343

SBUS<sb>:CAN:FAST:THReshold <SIC Threshold>

Sets a threshold value for the fast transceiver mode.

Suffix:

<sb> 1...4, index of the serial bus

Parameters:

<SIC Threshold>

Usage:

Asynchronous command

Manual operation: See "[Threshold](#)" on page 343

SBUS<sb>:CAN:FAST:HYSteresis <Hysteresis>

Sets a hysteresis value for the fast transceiver mode.

Suffix:

<sb> 1...4, index of the serial bus

Parameters:

<Hysteresis>

Usage: Asynchronous command

Manual operation: See "[Threshold](#)" on page 343

SBUS<sb>:CAN:XDATA:DBITrate <XLBitrate>

Sets the bit rate of the data phase for the CAN XL frame.

Suffix:

<sb> 1...4, index of the serial bus

Parameters:

<XLBitrate> Range: 10000 to 15000000
Increment: 100
*RST: 10000000
Default unit: bps

Usage: Asynchronous command

Manual operation: See "[XL bit rate](#)" on page 342

SBUS<sb>:CAN:XDATA:SAMplepoint <XLSamplePoint>

Sets the position of the sample point within the bit in percent of the nominal bit time for the CAN XL frame.

Suffix:

<sb> 1...4, index of the serial bus

Parameters:

<XLSamplePoint> Range: 30 to 90
Increment: 5
*RST: 66
Default unit: %

Usage: Asynchronous command

Manual operation: See "[XL sample point](#)" on page 343

SBUS<sb>:CAN:TRCVmode <TransceiverMd>

Selects the transceiver mode for the CAN decoding.

Suffix:

<sb> 1...4, index of the serial bus

Parameters:

<TransceiverMd> SIC | FAST
 *RST: SIC

Usage: Asynchronous command

Manual operation: See "[Transceiver mode](#)" on page 342

SBUS<sb>:CAN:SYMBOLs <ShowSymbols>

Activates the symbol list to be used for decoding.

Suffix:

<sb> 1...4, index of the serial bus

Parameters:

<ShowSymbols> ON | OFF
 *RST: OFF

Usage: Asynchronous command

Manual operation: See "[Show symbols](#)" on page 344

SBUS<sb>:CAN:NEWList <FileName>

Loads a symbol list file.

Suffix:

<sb> 1...4, index of the serial bus

Setting parameters:

<FileName> String parameter with path and file name.

Example:

```
SBUS1:CAN:NEWList
'home/storage/userData/Protocol/CAN.csv'
SBUS1:CAN:SYMBOLs ON
```

Usage: Setting only
 Asynchronous command

Manual operation: See "[Show symbols](#)" on page 344

SBUS<sb>:CAN:POSition <CAN position>

Sets the vertical position of the CAN signal.

Suffix:

<sb> 1...4, index of the serial bus

Parameters:

<CAN position>

Usage: Asynchronous command

SBUS<sb>:CAN:SCALe <CAN scale>

Set the vertical scale of the indicated CAN signal.

Suffix:

<sb> 1...4, index of the serial bus

Parameters:

<CAN scale>

Usage:

Asynchronous command

17.16.5.2 Trigger

Trigger commands for serial buses affect the current trigger source. Therefore, set the trigger source to the required serial bus with **TRIGger:EVENT<ev>:SOURce** before sending the bus-specific trigger commands.

| | |
|---------------------------------------|-----|
| TRIGger:CAN:TYPE..... | 707 |
| TRIGger:CAN:DCONdition..... | 707 |
| TRIGger:CAN:DMIN..... | 708 |
| TRIGger:CAN:FDATa:DPOStion..... | 708 |
| TRIGger:CAN:DLC..... | 708 |
| TRIGger:CAN:DLCCONdition..... | 708 |
| TRIGger:CAN:FTYPE..... | 709 |
| TRIGger:CAN:ICONdition..... | 709 |
| TRIGger:CAN:IMAX..... | 709 |
| TRIGger:CAN:IMIN..... | 710 |
| TRIGger:CAN:ITYPe..... | 710 |
| TRIGger:CAN:FORMError..... | 710 |
| TRIGger:CAN:FDATa:SCERror..... | 710 |
| TRIGger:CAN:ACKError..... | 711 |
| TRIGger:CAN:BITSterror..... | 711 |
| TRIGger:CAN:CRCError..... | 711 |
| TRIGger:CAN:FDATa:BRS..... | 712 |
| TRIGger:CAN:FDATa:ESI..... | 712 |
| TRIGger:CAN:XDATa:AF:CONDItion..... | 712 |
| TRIGger:CAN:XDATa:AF:MAX..... | 713 |
| TRIGger:CAN:XDATa:AF:MIN..... | 713 |
| TRIGger:CAN:XDATa:SDT:CONDItion..... | 713 |
| TRIGger:CAN:XDATa:SDT:MAX..... | 713 |
| TRIGger:CAN:XDATa:SDT:MIN..... | 714 |
| TRIGger:CAN:XDATa:SEC..... | 714 |
| TRIGger:CAN:XDATa:VCID:CONDItion..... | 714 |
| TRIGger:CAN:XDATa:VCID:MAX..... | 715 |
| TRIGger:CAN:XDATa:VCID:MIN..... | 715 |

TRIGger:CAN:TYPE <Type>

Selects the trigger type for CAN analysis.

Parameters:

<Type>

STOF | EDOF | FTYP | ID | IDDT | ERRC

STOF

Start of Frame: triggers on the first edge of the dominant SOF bit (synchronization bit).

FTYP

Frame type: triggers on a specified frame type and on the identifier format.

ID

Identifier: Sets the trigger to one specific identifier or an identifier range.

To set the identifier, use `TRIGger:CAN:ICONdition`, `TRIGger:CAN:IMAX`, and `TRIGger:CAN:IMIN`.

IDDT

Identifier and data: Combination of identifier and data conditions.

To set the identifier condition, use `TRIGger:CAN:ICONdition`, `TRIGger:CAN:IMIN`, and `TRIGger:CAN:IMAX`.

To set the data condition, use `TRIGger:CAN:DCONdition` and `TRIGger:CAN:DMIN`.

ERRC

Error condition: Define the error types with:

`TRIGger:CAN:ACKerror``TRIGger:CAN:BITSterror``TRIGger:CAN:CRCErrror``TRIGger:CAN:FORMerror``TRIGger:CAN:FDATA:SCERror`

*RST: STOF

Usage: Asynchronous command

Manual operation: See "[Type](#)" on page 350

TRIGger:CAN:DCONdition <DataOperator>

Sets the operator to set a specific data pattern or a data pattern range.

Parameters:

<DataOperator>

EQUAL | NEQUAL | LTHan | LETHan | GTHan | GETHan

EQUAL | NEQUAL | LTHan | LETHan | GTHan | GETHan

Equal, not equal, less than, less or equal than, greater than, greater or equal than. These conditions require one data pattern to be set with `TRIGger:CAN:DMIN`.

*RST: EQUAL

Usage: Asynchronous command

Manual operation: See ["Data pattern"](#) on page 355

TRIGger:CAN:DMIN <DataPattern>

Sets a data pattern, or sets the start value of a data pattern range.

Parameters:

<DataPattern> List of comma separated values

Usage: Asynchronous command

Manual operation: See ["Data pattern"](#) on page 355

TRIGger:CAN:FDATA:DPOsition <DataPosition>

Defines the number of the first data byte at which the data pattern may start.

Parameters:

<DataPosition> Range: 1 to 2048
Increment: 1
*RST: 1

Usage: Asynchronous command

TRIGger:CAN:DLC <DLC>

Sets the data length code, the number of data bytes to be found. For complete definition, set also the operator with [TRIGger:CAN:DLCCondition](#).

Parameters:

<DLC> Range: CAN: 1 to 8, CAN FD: 1 to 15 (64 bytes)
Increment: 1
*RST: 0

Usage: Asynchronous command

Manual operation: See ["DLC"](#) on page 354

TRIGger:CAN:DLCCondition <DLCOperator>

Operator to set the data length code.

The number of data bytes to be found is set with [TRIGger:CAN:DLC](#).

Parameters:

<DLCOperator> EQUal | GETHan
For little endian transfer direction, EQUal must be set.
*RST: GETHan

Usage: Asynchronous command

Manual operation: See ["DLC"](#) on page 354

TRIGger:CAN:FTYPE <FrameType>

Sets the CAN frame type.

Parameters:

<FrameType> CBFF | CBFR | CEFF | CEFR | FBFF | FEFF | XLFF | ERRor | OVERload

CBFF: classical base frame format data

CEFF: classical extended frame format data

FBFF: FD base frame format

FEFF: FD extended frame format

XLFF: XL frame format

ERR: error

OVLd: overload

*RST: CBFF

Usage: Asynchronous command

Manual operation: See "[Frame type](#)" on page 352

TRIGger:CAN:ICONdition <IdOperator>

Sets the operator to set a specific identifier or an identifier range.

Parameters:

<IdOperator> EQUal | NEQual | LTHan | LETHan | GTHan | GETHan | INRange | OORange

EQUal | NEQual | LTHan | LETHan | GTHan | GETHan

Equal, not equal, less than, less or equal than, greater than, greater or equal than. These conditions require one identifier pattern to be set with [TRIGger:CAN:IMIN](#).

INRange | OORange

In range / out of range: Set the minimum and maximum value of the range with [TRIGger:CAN:IMIN](#) and [TRIGger:CAN:IMAX](#).

*RST: EQUal

Usage: Asynchronous command

Manual operation: See "[Identifier](#)" on page 354

TRIGger:CAN:IMAX <IdPattern>

Sets the end value of an identifier range if [TRIGger:CAN:ICONdition](#) is set to INRange or OORange.

Parameters:

<IdPattern> List of comma separated values

Usage: Asynchronous command

Manual operation: See "[Identifier](#)" on page 354

TRIGger:CAN:IMIN <IdPattern>

Specifies a message identifier pattern, or sets the start value of an identifier range.

Parameters:

<IdPattern> List of comma separated values

Usage: Asynchronous command

Manual operation: See "[Identifier](#)" on page 354

TRIGger:CAN:ITYPE <IdentifierType>

Selects the format of data and remote frames.

Remote frames are not available in the CAN FD protocol.

Parameters:

<IdentifierType> B11 | B29

B11

11-bit identifier (standard format). The instrument triggers on the sample point of the IDE bit.

B29

29-bit identifier (extended format). The instrument triggers on the sample point of the RTR bit.

ANY

The ID type and ID pattern are not relevant for the trigger condition.

*RST: B11

Usage: Asynchronous command

Manual operation: See "[ID type](#)" on page 355

TRIGger:CAN:FORMerror <FormError>

Triggers when a fixed-form bit field contains one or more illegal bits.

Available, if [TRIGger:CAN:TYPE](#) is set to `ERRC`.

Parameters:

<FormError> ON | OFF

*RST: ON

Usage: Asynchronous command

Manual operation: See "[Error conditions](#)" on page 356

TRIGger:CAN:FDATa:SCERror <StuffCntErr>

Triggers on stuff count errors. A stuff bit error occurs, if more than five consecutive bits of the same level occur on the bus.

Available, if `TRIGger:CAN:TYPE` is set to `ERRor`.

Parameters:

<StuffCntErr> ON | OFF
*RST: ON

Usage: Asynchronous command

Manual operation: See "[Error conditions](#)" on page 356

TRIGger:CAN:ACKError <AckError>

Triggers when the transmitter does not receive an acknowledgment - a dominant bit during the ACK Slot.

Available, if `TRIGger:CAN:TYPE` is set to `ERRC`.

Parameters:

<AckError> ON | OFF
*RST: ON

Usage: Asynchronous command

Manual operation: See "[Error conditions](#)" on page 356

TRIGger:CAN:BITSterror <BitStuffError>

Triggers if a stuff error occurs - when the 6th consecutive equal bit level in the mentioned fields is detected.

Available, if `TRIGger:CAN:TYPE` is set to `ERRC`.

Parameters:

<BitStuffError> ON | OFF
*RST: ON

Usage: Asynchronous command

Manual operation: See "[Error conditions](#)" on page 356

TRIGger:CAN:CRCErrror <ChecksumError>

Triggers on CRC errors. A CRC error occurs when the CRC calculated by the receiver differs from the received value in the CRC sequence.

Available, if `TRIGger:CAN:TYPE` is set to `ERRC`.

Parameters:

<ChecksumError> ON | OFF
*RST: ON

Usage: Asynchronous command

Manual operation: See "[Error conditions](#)" on page 356

TRIGger:CAN:FDATa:BRS <BRS_Bit>

Sets the bit rate switch bit.

Parameters:

<BRS_Bit> ONE | ZERO | DC

ONE: the bit rate switches from the bit rate of the arbitration phase to the faster data rate.

*RST: ONE

Usage: Asynchronous command

Manual operation: See "BRS, ESI" on page 355

TRIGger:CAN:FDATa:ESI <ESI_Bit>

Sets the error state indicator bit.

Parameters:

<ESI_Bit> ONE | ZERO | DC

DC: do not care, bit is not relevant.

*RST: DC

Usage: Asynchronous command

Manual operation: See "BRS, ESI" on page 355

TRIGger:CAN:XDATa:AF:CONDition <AfOperator>

Sets the comparison condition for the acceptance field to a specific value or a range.

Parameters:

<AfOperator> EQUal | NEQual | LTHan | LETHan | GTHan | GETHan | INRange | OORange

EQUal | NEQual | LTHan | LETHan | GTHan | GETHan

Equal, not equal, less than, less or equal than, greater than, greater or equal than. These conditions require one pattern to be set with [TRIGger:CAN:XDATa:AF:MIN](#).

INRange | OORange

In range / out of range: Set the minimum and maximum value of the range with [TRIGger:CAN:XDATa:AF:MIN](#) and [TRIGger:CAN:XDATa:AF:MAX](#).

*RST: EQUal

Usage: Asynchronous command

Manual operation: See "AF" on page 356

TRIGger:CAN:XDATA:AF:MAX <AfPatternTo>

Sets the end value of an acceptance field if [TRIGger:CAN:XDATA:AF:CONDition](#) is set to [INRange](#) or [OORange](#).

Parameters:

<AfPatternTo> List of comma separated values

Usage: Asynchronous command

Manual operation: See "[AF](#)" on page 356

TRIGger:CAN:XDATA:AF:MIN <AfPattern>

Specifies an acceptance field pattern, or sets the start value of a range.

Parameters:

<AfPattern> List of comma separated values

Usage: Asynchronous command

Manual operation: See "[AF](#)" on page 356

TRIGger:CAN:XDATA:SDT:CONDition <SdtOperator>

Sets the comparison condition for the service data unit type to a specific value or a range.

Parameters:

<SdtOperator> [EQUal](#) | [NEQUal](#) | [LTHan](#) | [LETHan](#) | [GTHan](#) | [GETHan](#) | [INRange](#) | [OORange](#)

[EQUal](#) | [NEQUal](#) | [LTHan](#) | [LETHan](#) | [GTHan](#) | [GETHan](#)

Equal, not equal, less than, less or equal than, greater than, greater or equal than. These conditions require one pattern to be set with [TRIGger:CAN:XDATA:SDT:MIN](#).

[INRange](#) | [OORange](#)

In range / out of range: Set the minimum and maximum value of the range with [TRIGger:CAN:XDATA:SDT:MIN](#) and [TRIGger:CAN:XDATA:SDT:MAX](#).

*RST: [EQUal](#)

Usage: Asynchronous command

Manual operation: See "[SDT](#)" on page 355

TRIGger:CAN:XDATA:SDT:MAX <SdtPatternTo>

Sets the end value of a service data unit type range if [TRIGger:CAN:XDATA:SDT:CONDition](#) is set to [INRange](#) or [OORange](#).

Parameters:

<SdtPatternTo> List of comma separated values

Usage: Asynchronous command

Manual operation: See "SDT" on page 355

TRIGger:CAN:XDATA:SDT:MIN <SdtPattern>

Specifies a service data unit type pattern, or sets the start value of a range.

Parameters:

<SdtPattern> List of comma separated values

Usage: Asynchronous command

Manual operation: See "SDT" on page 355

TRIGger:CAN:XDATA:SEC <SEC_Bit>

Sets a value for the simple extended content (SEC) field. It indicates, if the CAN XL data frame uses the CADsec protocol.

Parameters:

<SEC_Bit> ONE | ZERO | DC
*RST: DC

Usage: Asynchronous command

Manual operation: See "SEC" on page 356

TRIGger:CAN:XDATA:VCID:CONDition <VcidOperator>

Sets the comparison condition for the VCID to a specific value or a range.

Parameters:

<VcidOperator> EQUal | NEQual | LTHan | LETHan | GTHan | GETHan | INRange | OORange

EQUal | NEQual | LTHan | LETHan | GTHan | GETHan

Equal, not equal, less than, less or equal than, greater than, greater or equal than. These conditions require one pattern to be set with [TRIGger:CAN:XDATA:VCID:MIN](#).

INRange | OORange

In range / out of range: Set the minimum and maximum value of the range with [TRIGger:CAN:XDATA:VCID:MIN](#) and [TRIGger:CAN:XDATA:VCID:MAX](#).

*RST: EQUal

Usage: Asynchronous command

Manual operation: See "VCID" on page 356

TRIGger:CAN:XDATA:VCID:MAX <VcidPatternTo>

Sets the end value of a VCID range if **TRIGger:CAN:XDATA:VCID:CONDition** is set to **INRange** or **OORange**.

Parameters:

<VcidPatternTo> List of comma separated values

Usage: Asynchronous command

Manual operation: See "**VCID**" on page 356

TRIGger:CAN:XDATA:VCID:MIN <VcidPattern>

Specifies a VCID pattern, or sets the start value of a range.

Parameters:

<VcidPattern> List of comma separated values

Usage: Asynchronous command

Manual operation: See "**VCID**" on page 356

17.16.5.3 Filter

| | |
|--|-----|
| SBUS<sb>:CAN:FILTer:ENABle..... | 715 |
| SBUS<sb>:CAN:FILTer:BIT..... | 716 |
| SBUS<sb>:CAN:FILTer:FRAMe<fr>:FLD<fl>:BIT..... | 716 |
| SBUS<sb>:CAN:FILTer:DMAX..... | 716 |
| SBUS<sb>:CAN:FILTer:FRAMe<fr>:FLD<fl>:DMAX..... | 716 |
| SBUS<sb>:CAN:FILTer:DMIN..... | 716 |
| SBUS<sb>:CAN:FILTer:FRAMe<fr>:FLD<fl>:DMIN..... | 716 |
| SBUS<sb>:CAN:FILTer:DOPerator..... | 717 |
| SBUS<sb>:CAN:FILTer:FRAMe<fr>:FLD<fl>:DOPerator..... | 717 |
| SBUS<sb>:CAN:FILTer:ERENable..... | 717 |
| SBUS<sb>:CAN:FILTer:ERRor<n>:ENABle..... | 717 |
| SBUS<sb>:CAN:FILTer:FIENable..... | 717 |
| SBUS<sb>:CAN:FILTer:FRAMe<fr>:FLD<fl>:ENABle..... | 717 |
| SBUS<sb>:CAN:FILTer:FRENable..... | 718 |
| SBUS<sb>:CAN:FILTer:FRAMe<fr>:ENABle..... | 718 |
| SBUS<sb>:CAN:FILTer:IMAX..... | 718 |
| SBUS<sb>:CAN:FILTer:FRAMe<fr>:FLD<fl>:IMAX..... | 718 |
| SBUS<sb>:CAN:FILTer:IMIN..... | 718 |
| SBUS<sb>:CAN:FILTer:FRAMe<fr>:FLD<fl>:IMIN..... | 718 |
| SBUS<sb>:CAN:FILTer:IOPerator..... | 719 |
| SBUS<sb>:CAN:FILTer:FRAMe<fr>:FLD<fl>:IOPerator..... | 719 |

SBUS<sb>:CAN:FILTer:ENABle <Enable>

Enables the filtering on CAN frames. Only the frames that match the selected filter conditions are displayed.

Suffix:
 <sb> 1...4, index of the serial bus

Parameters:
 <Enable> ON | OFF
 *RST: ON

Usage: Asynchronous command

SBUS<sb>:CAN:FILTER:BIT <Frame>,<Field>,<Bit>
SBUS<sb>:CAN:FILTER:FRAME<fr>:FLD<fl>:BIT <BitState>

Sets the operator for the data pattern in the selected field of the selected frame.

Suffix:
 <sb> 1...4, index of the serial bus
 <fr> index of the frame
 <fl> index of the field

Parameters:
 <BitState> ONE | ZERO
 *RST: ZERO

Usage: Asynchronous command

Manual operation: See "Edit" on page 348

SBUS<sb>:CAN:FILTER:DMAX <Frame>,<Field>,<Data>
SBUS<sb>:CAN:FILTER:FRAME<fr>:FLD<fl>:DMAX <Data_Max>

Sets the end value of a data pattern range if the operator is set to INRange or OORANGE.

Suffix:
 <sb> 1...4, index of the serial bus
 <fr> index of the frame
 <fl> index of the field

Parameters:
 <Data_Max>

Usage: Asynchronous command

Manual operation: See "Edit" on page 348

SBUS<sb>:CAN:FILTER:DMIN <Frame>,<Field>,<Data>
SBUS<sb>:CAN:FILTER:FRAME<fr>:FLD<fl>:DMIN <Data_Min>

Specifies the data pattern, or sets the start value of a data pattern range.

Suffix:
 <sb> 1...4, index of the serial bus

<fr> index of the frame

<fl> index of the field

Parameters:

<Data_Min>

Usage: Asynchronous command

Manual operation: See ["Edit"](#) on page 348

SBUS<sb>:CAN:FILTer:DOPerator <Frame>,<Field>,<Operator>

SBUS<sb>:CAN:FILTer:FRAMe<fr>:FLD<fl>:DOPerator <Data_Operator>

Sets the operator for the data pattern in the selected field of the selected frame.

Suffix:

<sb> 1...4, index of the serial bus

<fr> index of the frame

<fl> index of the field

Parameters:

<Data_Operator> EQUal | NEQUal | LTHan | LETHan | GTHan | GETHan |
INRange | OORange

*RST: EQUal

Usage: Asynchronous command

Manual operation: See ["Edit"](#) on page 348

SBUS<sb>:CAN:FILTer:ERENable <ErrorName>,<Enabler>

SBUS<sb>:CAN:FILTer:ERRor<n>:ENABLE <Enable>

Defines the error type to be filtered on.

Suffix:

<sb> 1...4, index of the serial bus

<n> index of the error

Parameters:

<Enable> ON | OFF

*RST: ON

Usage: Asynchronous command

Manual operation: See ["Error type"](#) on page 349

SBUS<sb>:CAN:FILTer:FIENable <Frame>,<Field>,<Enabler>

SBUS<sb>:CAN:FILTer:FRAMe<fr>:FLD<fl>:ENABLE <CondEnabler>

Enables or disables the checking condition for the selected field of the selected frame.

Suffix:

<sb> 1...4, index of the serial bus

<fr> index of the frame

<fl> index of the field

Parameters:

<CondEnabler> ON | OFF
*RST: OFF

Usage: Asynchronous command

Manual operation: See "Edit" on page 348

SBUS<sb>:CAN:FILTer:FREnable <Frame>,<Enabler>

SBUS<sb>:CAN:FILTer:FRAMe<fr>:ENABle <Enable>

Enables the filtering on CAN frames. Only the frames that match the selected filter conditions are displayed.

Suffix:

<sb> 1...4, index of the serial bus

<fr> index of the frame

Parameters:

<Enable> ON | OFF
*RST: ON

Usage: Asynchronous command

Manual operation: See "Frame type" on page 347

SBUS<sb>:CAN:FILTer:IMAX <Frame>,<Field>,<Data>

SBUS<sb>:CAN:FILTer:FRAMe<fr>:FLD<fl>:IMAX <Index_Max>

Sets the end value of an index range if the operator is set to INRange.

Suffix:

<sb> 1...4, index of the serial bus

<fr> index of the frame

<fl> index of the field

Parameters:

<Index_Max> Range: 1 to 65535
Increment: 1
*RST: 65535

Usage: Asynchronous command

Manual operation: See "Edit" on page 348

SBUS<sb>:CAN:FILTer:IMIN <Frame>,<Field>,<Data>

SBUS<sb>:CAN:FILTer:FRAMe<fr>:FLD<fl>:IMIN <Index_Min>

Specifies the index, or sets the start value of an index range.

Suffix:

| | |
|------|--------------------------------|
| <sb> | 1...4, index of the serial bus |
| <fr> | index of the frame |
| <fl> | index of the field |

Parameters:

| | |
|-------------|-------------------|
| <Index_Min> | Range: 1 to 65535 |
| | Increment: 1 |
| | *RST: 1 |

Usage: Asynchronous command

Manual operation: See "Edit" on page 348

SBUS<sb>:CAN:FILTer:IOPerator <Frame>,<Field>,<Operator>

SBUS<sb>:CAN:FILTer:FRAMe<fr>:FLD<fl>:IOPerator <Index_Operator>

Sets the operator for the index in the selected field of the selected frame.

Suffix:

| | |
|------|--------------------------------|
| <sb> | 1...4, index of the serial bus |
| <fr> | index of the frame |
| <fl> | index of the field |

Parameters:

| | |
|------------------|-------------------------|
| <Index_Operator> | EQUal INRange RANGE |
| | *RST: INRange |

Usage: Asynchronous command

Manual operation: See "Edit" on page 348

17.16.5.4 Decode results

| | |
|---------------------------------------|-----|
| SBUS<sb>:CAN:FCOunt? | 720 |
| SBUS<sb>:CAN:FRAMe<fr>:ACKState? | 720 |
| SBUS<sb>:CAN:FRAMe<fr>:ACKValue? | 721 |
| SBUS<sb>:CAN:FRAMe<fr>:BSEPosition? | 721 |
| SBUS<sb>:CAN:FRAMe<fr>:BYTE<o>:STATe? | 721 |
| SBUS<sb>:CAN:FRAMe<fr>:BYTE<o>:VALue? | 722 |
| SBUS<sb>:CAN:FRAMe<fr>:CSState? | 722 |
| SBUS<sb>:CAN:FRAMe<fr>:CSValue? | 722 |
| SBUS<sb>:CAN:FRAMe<fr>:DATA? | 723 |
| SBUS<sb>:CAN:FRAMe<fr>:DLCState? | 723 |
| SBUS<sb>:CAN:FRAMe<fr>:DLCValue? | 723 |
| SBUS<sb>:CAN:FRAMe<fr>:FERCause? | 724 |
| SBUS<sb>:CAN:FRAMe<fr>:IDState? | 724 |
| SBUS<sb>:CAN:FRAMe<fr>:IDTYpe? | 724 |
| SBUS<sb>:CAN:FRAMe<fr>:IDValue? | 725 |
| SBUS<sb>:CAN:FRAMe<fr>:NDBYtes? | 725 |

| | |
|---------------------------------------|-----|
| SBUS<sb>:CAN:FRAMe<fr>:PDATA? | 725 |
| SBUS<sb>:CAN:FRAMe<fr>:SDATA? | 726 |
| SBUS<sb>:CAN:FRAMe<fr>:SDExport? | 726 |
| SBUS<sb>:CAN:FRAMe<fr>:START? | 726 |
| SBUS<sb>:CAN:FRAMe<fr>:STATus? | 726 |
| SBUS<sb>:CAN:FRAMe<fr>:STOP? | 727 |
| SBUS<sb>:CAN:FRAMe<fr>:STUFF? | 727 |
| SBUS<sb>:CAN:FRAMe<fr>:SYMBol? | 728 |
| SBUS<sb>:CAN:FRAMe<fr>:TYPE? | 728 |
| SBUS<sb>:CAN:FRAMe<fr>:XDATa<o>:AF? | 728 |
| SBUS<sb>:CAN:FRAMe<fr>:XDATa<o>:PCRC? | 729 |
| SBUS<m>:CAN:FRAMe<fr>:XDATa<o>:SBC? | 729 |
| SBUS<sb>:CAN:FRAMe<fr>:XDATa<o>:SDT? | 729 |
| SBUS<sb>:CAN:FRAMe<fr>:XDATa<o>:SEC? | 730 |
| SBUS<sb>:CAN:FRAMe<fr>:XDATa<o>:VCID? | 730 |
| SBUS<sb>:CAN:FRAMe<fr>:FDATa<o>:ESI? | 731 |
| SBUS<sb>:CAN:FRAMe<fr>:FDATa<o>:BRS? | 731 |
| SBUS<sb>:CAN:FRAMe<fr>:DBITrate? | 731 |
| SBUS<sb>:CAN:FRAMe<fr>:NBITrate? | 732 |
| SBUS<sb>:CAN:FRAMe<fr>:COUNT? | 732 |
| SBUS<sb>:CAN:FRAMe<fr>:SBC? | 732 |
| SBUS<sb>:CAN:FRAMe<fr>:XDATa<o>:FCRC? | 732 |

SBUS<sb>:CAN:FCOunt?

Returns the number of decoded frames for the CAN protocol analysis.

Suffix:

<sb> 1...4, index of the serial bus

Return values:

<Count>

Usage:

Query only
Asynchronous command

SBUS<sb>:CAN:FRAMe<fr>:ACKState?

Return the states of the acknowledgment field.

Suffix:

<sb> 1...4, index of the serial bus

<fr> index of the frame

Return values:

<FrameAckState> OK | ERRor | UNDF
UNDF: Undefined
*RST: OK

Usage:

Query only
Asynchronous command

SBUS<sb>:CAN:FRAME<fr>:ACKValue?

Returns the value of the acknowledge slot for the selected frame.

Suffix:

<sb> 1...4, index of the serial bus
 <fr> index of the frame

Return values:

<FrameAckValue> Range: 0 to 1
 Increment: 1
 *RST: 0

Usage: Query only
 Asynchronous command

SBUS<sb>:CAN:FRAME<fr>:BSEPosition?

Returns the location of a bit stuffing error.

Suffix:

<sb> 1...4, index of the serial bus
 <fr> index of the frame

Return values:

<BtStuffErrPos> Time when the error occurred.
 Range: 0 to 5000
 Increment: 1
 *RST: 0

Usage: Query only
 Asynchronous command

SBUS<sb>:CAN:FRAME<fr>:BYTE<o>:STATe?

Returns the state of the specified byte.

Suffix:

<sb> 1...4, index of the serial bus
 <fr> index of the frame
 <o> *
 Selects the byte number.

Return values:

<State> OK | EOFD | ACKD | NOACK | CRCd | CRC | SERRror |
 FORM | BTST | UNKNown | INComplete
 UNDF: Undefined
 *RST: OK

Usage: Query only
 Asynchronous command

SBUS<sb>:CAN:FRAME<fr>:BYTE<o>:VALue?

Returns the value of the specified byte.

Suffix:

| | |
|------|--------------------------------|
| <sb> | 1...4, index of the serial bus |
| <fr> | index of the frame |
| <o> | * |
| | Selects the byte number. |

Return values:

| | |
|---------|----------------------------------|
| <Value> | Range: 0 to 18446744073709551615 |
| | Increment: 1 |
| | *RST: 0 |

Usage:

Query only
Asynchronous command

SBUS<sb>:CAN:FRAME<fr>:CSState?

Return the states of the checksum field (CRC).

Suffix:

| | |
|------|--------------------------------|
| <sb> | 1...4, index of the serial bus |
| <fr> | index of the frame |

Return values:

| | |
|-----------------|-------------------|
| <ChecksumState> | OK ERRor UNDF |
| | *RST: OK |

Usage:

Query only
Asynchronous command

SBUS<sb>:CAN:FRAME<fr>:CSValue?

Returns the CRC sequence value of the selected frame.

Suffix:

| | |
|------|--------------------------------|
| <sb> | 1...4, index of the serial bus |
| <fr> | index of the frame |

Return values:

| | |
|-----------------|------------------------|
| <ChecksumValue> | Range: 0 to 4294967295 |
| | Increment: 1 |
| | *RST: 0 |

Usage:

Query only
Asynchronous command

SBUS<sb>:CAN:FRAME<fr>:DATA?

Returns the data of the specified frame.

Suffix:

<sb> 1...4, index of the serial bus
<fr> index of the frame

Return values:

<FrameData> Comma-separated list of values. The first value is the number of bytes, followed by the values of the data bytes.

Example:

```
BUS1:CAN:FRAME2:DATA?  
--> 3,208,231,32
```

Returns the data of the second frame: the number of bytes is 3 data (first value).

Usage: Query only

SBUS<sb>:CAN:FRAME<fr>:DLCState?

Return the states of the state of data length code.

Suffix:

<sb> 1...4, index of the serial bus
<fr> index of the frame

Return values:

<FrameDLCState> OK | ERRor | UNDF
*RST: OK

Usage: Query only
Asynchronous command

SBUS<sb>:CAN:FRAME<fr>:DLCValue?

Returns the data length code of the selected frame - the number of data bytes in the frame.

Suffix:

<sb> 1...4, index of the serial bus
<fr> index of the frame

Return values:

<FrameDLCValue> Range: 0 to 2047
Increment: 1
*RST: 0

Usage: Query only
Asynchronous command

SBUS<sb>:CAN:FRAME<fr>:FERCause?

Returns information on a form error, if the frame status query ([SBUS<sb>:CAN:FRAME<fr>:STaTus?](#)) returned a form error.

Suffix:

<sb> 1...4, index of the serial bus

<fr> index of the frame

Return values:

<FormErrorCause> NONE | CRCDerror | ACKDerror | FSBE | RESerror

CRCDerror = CRC delimiter error

ACKDerror = ACK delimiter error

FSBE = fixed stuff bit error (CAN FD ISO only)

RESerror = reserved bit error

*RST: NONE

Usage:

Query only

Asynchronous command

SBUS<sb>:CAN:FRAME<fr>:IDStAtE?

Return the states of the identifier state.

Suffix:

<sb> 1...4, index of the serial bus

<fr> index of the frame

Return values:

<IdtfSt> OK | ERRor | UNDF

UNDF: Undefined

*RST: OK

Usage:

Query only

Asynchronous command

SBUS<sb>:CAN:FRAME<fr>:IDTYpe?

Returns the identifier type of the selected frame, the identifier format of data and remote frames.

Suffix:

<sb> 1...4, index of the serial bus

<fr> index of the frame

Return values:

<IdentifierType> B11 | B29

B11: standard format, 11 bit

B29: extended format, 29 bit

*RST: B11

Usage: Query only
Asynchronous command

SBUS<sb>:CAN:FRAME<fr>:IDValue?

Returns the identifier value of the selected frame.

Suffix:

<sb> 1...4, index of the serial bus

<fr> index of the frame

Return values:

<IdtfVal> Range: 0 to 536870911
Increment: 1
*RST: 0

Usage: Query only
Asynchronous command

SBUS<sb>:CAN:FRAME<fr>:NDBYtes?

Returns the number of data bytes.

Suffix:

<sb> 1...4, index of the serial bus

<fr> index of the frame

Return values:

<NDBytes> Range: 0 to 2048
Increment: 1
*RST: 1

Usage: Query only
Asynchronous command

SBUS<sb>:CAN:FRAME<fr>:PDATa?

Returns a list of comma-separated pattern data values.

Suffix:

<sb> 1...4, index of the serial bus

<fr> index of the frame

Return values:

<NDBytes>

Usage: Query only
Asynchronous command

SBUS<sb>:CAN:FRAME<fr>:SDATa?

Returns the symbolic data of the specified frame.

Suffix:

<sb> 1...4, index of the serial bus

<fr> index of the frame

Return values:

<SymbolicData> Comma-separated list of values. The first value is the number of bytes, followed by the values of the data bytes.

Usage:

Query only
Asynchronous command

SBUS<sb>:CAN:FRAME<fr>:SDEXport?

Returns the symbolic data of the frame in export format.

Suffix:

<sb> 1...4, index of the serial bus

<fr> index of the frame

Return values:

<SymbolicData>

Usage:

Query only
Asynchronous command

SBUS<sb>:CAN:FRAME<fr>:START?

Return the start time of the selected frame.

Suffix:

<sb> 1...4, index of the serial bus

<fr> index of the frame

Return values:

<FrameStart> Range: -1E+26 to 1E+26
Increment: 1E-10
*RST: 0
Default unit: s

Usage:

Query only
Asynchronous command

SBUS<sb>:CAN:FRAME<fr>:STATUs?

Returns the overall state of the selected frame.

Suffix:

<sb> 1...4, index of the serial bus

<fr> index of the frame

Return values:

<FrameState> OK | EOFD | ACKD | NOACK | CRCd | CRC | SERRror | FORM | BTST | UNKNown | INComplete

OK: the frame is valid.

EOFD: Wrong end of frame.

ACKD: Wrong ACK delimiter occurred.

NOACK: Acknowledge is missing.

CRCd: Wrong CRC delimiter occurred.

CRC: Cyclic redundancy check failed.

SERRror: Stuff count error (CAN FD ISO only).

FORM: Fixed-bit form error.

BTST: Bit stuffing error occurred.

INSufficient: The frame is not completely contained in the acquisition. The acquired part of the frame is valid.

*RST: OK

Usage:

Query only
Asynchronous command

SBUS<sb>:CAN:FRAME<fr>:STOP?

Return the stop time of the selected frame.

Suffix:

<sb> 1...4, index of the serial bus

<fr> index of the frame

Return values:

<FrameStop> Range: -1E+26 to 1E+26

Increment: 1E-10

*RST: 0

Default unit: s

Usage:

Query only
Asynchronous command

SBUS<sb>:CAN:FRAME<fr>:STUFF?

Returns the value of the stuff count field.

Suffix:

<sb> 1...4, index of the serial bus

<fr> index of the frame

Return values:

<StuffCount> Range: 0 to 7

Increment: 1

*RST: 0

Usage: Query only
Asynchronous command

SBUS<sb>:CAN:FRAMe<fr>:SYMBol?

Returns the symbol of the specified frame if the label list is enabled.

Suffix:
 <sb> 1...4, index of the serial bus
 <fr> index of the frame

Return values:
 <Label> String with symbol of the identifier

Example: BUS:CAN:FRAMe:SYMBol?
 Response: Temperature

Usage: Query only

SBUS<sb>:CAN:FRAMe<fr>:TYPE?

Returns the frame type of the selected frame.

Suffix:
 <sb> 1...4, index of the serial bus
 <fr> index of the frame

Return values:
 <FrameType> CBFF | CBFR | CEFF | CEFR | FBFF | FEFF | XLFF | ERRor |
 OVERload | UNDEFINED

CBFF: classical base frame format data
 CBFRremote: classical base frame format remote
 CEFF: classical extended frame format data
 CEFRremote: classical extended frame format remote
 FBFF: FD base frame format
 FEFF: FD extended frame format
 XLFF: XL frame format
 ERR: error
 OVLd: overload
 *RST: CBFF

Usage: Query only
Asynchronous command

SBUS<sb>:CAN:FRAMe<fr>:XDATa<o>:AF?

Returns the value of the acceptance field for the selected frame.

Suffix:
 <sb> 1...4, index of the serial bus

<fr> index of the frame
 <o> index of the field

Return values:
 <AF> Range: 0 to 4294967295
 Increment: 1
 *RST: 0

Usage: Query only
 Asynchronous command

SBUS<sb>:CAN:FRAME<fr>:XDATa<o>:PCRC?

Returns the value of the preamble cyclic redundant check (PCRC) for the selected frame.

Suffix:
 <sb> 1...4, index of the serial bus
 <fr> index of the frame
 <o> index of the field

Return values:
 <PCRC> Range: 0 to 65535
 Increment: 1
 *RST: 0

Usage: Query only
 Asynchronous command

SBUS<m>:CAN:FRAME<fr>:XDATa<o>:SBC?

Returns the value of the stuff bit count (SBC) field for the selected CAN XL frame.

Suffix:
 <m> 1...4, index of the serial bus
 <fr> index of the frame
 <o> index of the field

Return values:
 <SBC> Range: 0 to 7
 Increment: 1
 *RST: 0

Usage: Query only
 Asynchronous command

SBUS<sb>:CAN:FRAME<fr>:XDATa<o>:SDT?

Returns the value of the service data unit field for the selected frame.

Suffix:
 <sb> 1...4, index of the serial bus
 <fr> index of the frame
 <o> index of the field

Return values:
 <SDT> Range: 0 to 255
 Increment: 1
 *RST: 0

Usage: Query only
 Asynchronous command

SBUS<sb>:CAN:FRAME<fr>:XDATa<o>:SEC?

Returns the value of the simple extended content (SEC) field for the selected CAN XL frame.

Suffix:
 <sb> 1...4, index of the serial bus
 <fr> index of the frame
 <o> index of the field

Return values:
 <SEC> Range: 0 to 1
 Increment: 1
 *RST: 0

Usage: Query only
 Asynchronous command

SBUS<sb>:CAN:FRAME<fr>:XDATa<o>:VCID?

Returns the value of the VCID field for the selected CAN XL frame.

Suffix:
 <sb> 1...4, index of the serial bus
 <fr> index of the frame
 <o> index of the field

Return values:
 <VCID> Range: 0 to 255
 Increment: 1
 *RST: 0

Usage: Query only
 Asynchronous command

SBUS<sb>:CAN:FRAME<fr>:FDATa<o>:ESI?

Returns the value of the error state indicator (ESI) field for the selected frame.

Suffix:

<sb> 1...4, index of the serial bus
 <fr> index of the frame
 <o> index of the field

Return values:

<ESI> Range: 0 to 1
 Increment: 1
 *RST: 0

Usage: Query only
 Asynchronous command

SBUS<sb>:CAN:FRAME<fr>:FDATa<o>:BRS?

Returns the value of the bit rate switch (BRS) field for the selected frame.

Suffix:

<sb> 1...4, index of the serial bus
 <fr> index of the frame
 <o> index of the field

Return values:

<BRS> Range: 0 to 1
 Increment: 1
 *RST: 0

Usage: Query only
 Asynchronous command

SBUS<sb>:CAN:FRAME<fr>:DBITrate?

Returns the data bit rate of the frame.

Suffix:

<sb> 1...4, index of the serial bus
 <fr> index of the frame

Return values:

<DataBitRate> Range: 0 to 100000000000
 Increment: 100
 *RST: 0
 Default unit: bps

Usage: Query only
 Asynchronous command

SBUS<sb>:CAN:FRAME<fr>:NBITrate?

Returns the nominal bit rate of the frame.

Suffix:

<sb> 1...4, index of the serial bus
<fr> index of the frame

Return values:

<NominalBitRate> Range: 0 to 100000000000
 Increment: 100
 *RST: 0
 Default unit: bps

Usage: Query only
 Asynchronous command

SBUS<sb>:CAN:FRAME<fr>:COUNT?

Returns the number of decoded frames of the acquisition.

Suffix:

<sb> 1...4, index of the serial bus
<fr> index of the frame

Return values:

<Count>

Usage: Query only
 Asynchronous command

SBUS<sb>:CAN:FRAME<fr>:SBC?

Returns the value of the stuff bit count field.

Suffix:

<sb> 1...4, index of the serial bus
<fr> index of the frame

Return values:

<SBC> Range: 0 to 15
 Increment: 1
 *RST: 0

Usage: Query only
 Asynchronous command

SBUS<sb>:CAN:FRAME<fr>:XDATa<o>:FCRC?

Returns the value of the frame CRC for the selected frame.

| | |
|-----------------------|---|
| Suffix: | |
| <sb> | 1...4, index of the serial bus |
| <fr> | index of the frame |
| <o> | index of the field |
| Return values: | |
| <FCRC> | Range: 0 to 4294967295
Increment: 1
*RST: 0 |
| Usage: | Query only
Asynchronous command |

17.16.6 LIN (option R&S MXO5-K520)

Before R&S MXO 5 can accept the specific bus commands, make sure that:

- The decoding of the specified bus is enabled with `SBUS<sb>[:STATe]`.
- The bus is set to the correct type with `SBUS<sb>:TYPE`.

| | |
|--|-----|
| • Configuration | 733 |
| • Trigger | 735 |
| • Filter | 739 |
| • Decode results | 743 |

17.16.6.1 Configuration

| | |
|--|-----|
| SBUS<sb>:LIN:BITRate | 733 |
| SBUS<sb>:LIN:DATA:HYSTeresis | 734 |
| SBUS<sb>:LIN:DATA:SOURce | 734 |
| SBUS<sb>:LIN:DATA:THReshold | 734 |
| SBUS<sb>:LIN:POLarity | 734 |
| SBUS<sb>:LIN:STANdard | 735 |
| SBUS<sb>:LIN:POSition | 735 |
| SBUS<sb>:LIN:SCALe | 735 |

SBUS<sb>:LIN:BITRate <Bitrate>

Sets the number of transmitted bits per second. The maximum bit rate for LIN is 20 kbit/s.

| | |
|--------------------|--|
| Suffix: | |
| <sb> | 1...4, index of the serial bus |
| Parameters: | |
| <Bitrate> | Range: 1000 to 20000000
Increment: 1
*RST: 9600
Default unit: bps |
| Usage: | Asynchronous command |

Manual operation: See ["Bit rate"](#) on page 367

SBUS<sb>:LIN:DATA:HYSTeresis <Hysteresis>

Sets a value for the hysteresis for the data channel.

Suffix:

<sb> 1...4, index of the serial bus

Parameters:

<Hysteresis>

Usage: Asynchronous command

Manual operation: See ["Threshold"](#) on page 367

SBUS<sb>:LIN:DATA:SOURce <DataSource>

Sets the waveform of the data line.

Suffix:

<sb> 1...4, index of the serial bus

Parameters:

<DataSource> C1 | C2 | C3 | C4 | C5 | C6 | C7 | C8 | D0 | D1 | D2 | D3 | D4 | D5
| D6 | D7 | D8 | D9 | D10 | D11 | D12 | D13 | D14 | D15 | M1 | M2
| M3 | M4 | M5 | M6 | M7 | M8 | R1 | R2 | R3 | R4 | R5 | R6 | R7 |
R8

Usage: Asynchronous command

Manual operation: See ["Data"](#) on page 367

SBUS<sb>:LIN:DATA:THReshold <Threshold>

Sets a user-defined threshold value for the data channel.

Suffix:

<sb> 1...4, index of the serial bus

Parameters:

<Threshold>

Usage: Asynchronous command

Manual operation: See ["Threshold"](#) on page 367

SBUS<sb>:LIN:POLarity <Polarity>

Defines the idle state of the bus. The idle state is the recessive state and corresponds to a logic 1.

Suffix:

<sb> 1...4, index of the serial bus

Parameters:

<Polarity> IDLLow | IDLHigh
 *RST: IDLHigh

Usage: Asynchronous command

Manual operation: See "[Polarity](#)" on page 367

SBUS<sb>:LIN:STANdard <Standard>

Selects the version of the LIN standard.

Suffix:

<sb> 1...4, index of the serial bus

Parameters:

<Standard> V1X | V2X | J2602 | AUTO
 *RST: AUTO

Usage: Asynchronous command

Manual operation: See "[LIN standard](#)" on page 367

SBUS<sb>:LIN:POSition <LIN position>

Sets the vertical position of the LIN signal.

Suffix:

<sb> 1...4, index of the serial bus

Parameters:

<LIN position>

Usage: Asynchronous command

SBUS<sb>:LIN:SCALe <LIN scale>

Set the vertical scale of the indicated LIN signal.

Suffix:

<sb> 1...4, index of the serial bus

Parameters:

<LIN scale>

Usage: Asynchronous command

17.16.6.2 Trigger

Trigger commands for serial buses affect the current trigger source. Therefore, set the trigger source to the required serial bus with `TRIGger:EVENT<ev>:SOURce` before sending the bus-specific trigger commands.

| | |
|-----------------------------|-----|
| TRIGger:LIN:TYPE..... | 736 |
| TRIGger:LIN:CHKSError..... | 736 |
| TRIGger:LIN:DCondition..... | 737 |
| TRIGger:LIN:DMIN..... | 737 |
| TRIGger:LIN:DPosition..... | 737 |
| TRIGger:LIN:ICONdition..... | 737 |
| TRIGger:LIN:IMAX..... | 738 |
| TRIGger:LIN:IMIN..... | 738 |
| TRIGger:LIN:IPERror..... | 738 |
| TRIGger:LIN:SYERror..... | 738 |

TRIGger:LIN:TYPE <Type>

Selects the trigger type for LIN analysis.

Parameters:

<Type> STARTframe | ID | IDDT | WKFR | ERRC

STARTframe

Start of the frame. Triggers on the stop bit of the sync field.

ID

Sets the trigger to one specific identifier or an identifier range.

IDDT

Combination of identifier and data conditions.

WKFR

Wake-up frame.

ERRC

Error condition. Define the error types with:

TRIGger:LIN:CHKSError

TRIGger:LIN:IPERror

TRIGger:LIN:SYERror

*RST: STARTframe

Usage: Asynchronous command

Manual operation: See "Type" on page 368

TRIGger:LIN:CHKSError <ChecksumError>

Triggers on checksum errors.

Available, if TRIGger:LIN:TYPE is set to ERRC.

Parameters:

<ChecksumError> ON | OFF

*RST: ON

Usage: Asynchronous command

Manual operation: See "Error conditions" on page 370

TRIGger:LIN:DCONdition <DataOperator>

Sets the operator to set a specific data pattern or a data pattern range.

Parameters:

<DataOperator> EQUal | NEQUal | LTHan | LETHan | GTHan | GETHan
EQUal | NEQUal | LTHan | LETHan | GTHan | GETHan
 Equal, not equal, less than, less or equal than, greater than,
 greater or equal than. These conditions require one data pattern
 to be set with [TRIGger:LIN:DMIN](#).
 *RST: EQUal

Usage: Asynchronous command

Manual operation: See "[Data setup: Condition, Pattern, Position](#)" on page 369

TRIGger:LIN:DMIN <DataPattern>

Specifies a data pattern, or sets the start value of a data pattern range.

Parameters:

<DataPattern> List of comma separated values

Usage: Asynchronous command

Manual operation: See "[Data setup: Condition, Pattern, Position](#)" on page 369

TRIGger:LIN:DPOSition <DataPosition>

Sets the number of data events that are ignored, before trigger condition check of the data starts.

Parameters:

<DataPosition> Range: 1 to 4096
 Increment: 1
 *RST: 1

Usage: Asynchronous command

Manual operation: See "[Data setup: Condition, Pattern, Position](#)" on page 369

TRIGger:LIN:ICONdition <IdOperator>

Sets the operator to set a specific identifier or an identifier range.

Parameters:

<IdOperator> EQUal | NEQUal | LTHan | LETHan | GTHan | GETHan |
 INRange | OORange
EQUal | NEQUal | LTHan | LETHan | GTHan | GETHan
 Equal, not equal, less than, less or equal than, greater than,
 greater or equal than. These conditions require one identifier
 pattern to be set with [TRIGger:LIN:IMIN](#).

INRange | OORange

In range / out of range: Set the minimum and maximum value of the range with `TRIGger:LIN:IMIN` and `TRIGger:LIN:IMAX`.

*RST: EQUAL

Usage: Asynchronous command

Manual operation: See "[Identifier setup: Condition, Frame ID min, Frame ID max](#)" on page 369

TRIGger:LIN:IMAX <IdPattern>

Sets the end value of an identifier range if `TRIGger:LIN:ICONdition` is set to `INRange` or `OORange`.

Parameters:

<IdPattern> List of comma separated values

Usage: Asynchronous command

Manual operation: See "[Identifier setup: Condition, Frame ID min, Frame ID max](#)" on page 369

TRIGger:LIN:IMIN <IdPattern>

Specifies a secondary identifier pattern, or sets the start value of an identifier range.

Parameters:

<IdPattern> List of comma separated values

Usage: Asynchronous command

Manual operation: See "[Identifier setup: Condition, Frame ID min, Frame ID max](#)" on page 369

TRIGger:LIN:IPERror <IdParityError>

Triggers if an error occurs in the identifier parity bits. These are the bits 6 and 7 of the identifier.

Available, if `TRIGger:LIN:TYPE` is set to `ERRC`.

Parameters:

<IdParityError> ON | OFF

*RST: ON

Usage: Asynchronous command

Manual operation: See "[Error conditions](#)" on page 370

TRIGger:LIN:SYERror <SyncError>

Triggers if a synchronization error occurs.

Available, if `TRIGger:LIN:TYPE` is set to `ERRC`.

Parameters:

`<SyncError>` ON | OFF
`*RST:` ON

Usage: Asynchronous command

Manual operation: See "Error conditions" on page 370

17.16.6.3 Filter

There are two commands for each parameter, that you can use for defining the LIN settings.

For example, to set the *Frame type =Data > Field =ld >ld* value you can use one of the following commands:

- `SBUS:LIN:FILTer:FRAMe1:FLD1:DMIN 00`
 Defines the parameter by using the index `<m>` for the frame number and `<n>` for the field number.
- `SBUS:LIN:FILTer:DMIN "Data", "Address", 00`
 Defines the parameter by using the frame and field name.

| | |
|--|-----|
| <code>SBUS<sb>:LIN:FILTer:BIT</code> | 739 |
| <code>SBUS<sb>:LIN:FILTer:FRAMe<fr>:FLD<fl>:BIT</code> | 739 |
| <code>SBUS<sb>:LIN:FILTer:DMAX</code> | 740 |
| <code>SBUS<sb>:LIN:FILTer:FRAMe<fr>:FLD<fl>:DMAX</code> | 740 |
| <code>SBUS<sb>:LIN:FILTer:DMIN</code> | 740 |
| <code>SBUS<sb>:LIN:FILTer:FRAMe<fr>:FLD<fl>:DMIN</code> | 740 |
| <code>SBUS<sb>:LIN:FILTer:DOPerator</code> | 740 |
| <code>SBUS<sb>:LIN:FILTer:FRAMe<fr>:FLD<fl>:DOPerator</code> | 740 |
| <code>SBUS<sb>:LIN:FILTer:ERENable</code> | 741 |
| <code>SBUS<sb>:LIN:FILTer:ERRor<n>:ENABLE</code> | 741 |
| <code>SBUS<sb>:LIN:FILTer:FIENable</code> | 741 |
| <code>SBUS<sb>:LIN:FILTer:FRAMe<fr>:FLD<fl>:ENABLE</code> | 741 |
| <code>SBUS<sb>:LIN:FILTer:FRENable</code> | 742 |
| <code>SBUS<sb>:LIN:FILTer:FRAMe<fr>:ENABLE</code> | 742 |
| <code>SBUS<sb>:LIN:FILTer:IMAX</code> | 742 |
| <code>SBUS<sb>:LIN:FILTer:FRAMe<fr>:FLD<fl>:IMAX</code> | 742 |
| <code>SBUS<sb>:LIN:FILTer:IMIN</code> | 742 |
| <code>SBUS<sb>:LIN:FILTer:FRAMe<fr>:FLD<fl>:IMIN</code> | 742 |
| <code>SBUS<sb>:LIN:FILTer:IOPerator</code> | 743 |
| <code>SBUS<sb>:LIN:FILTer:FRAMe<fr>:FLD<fl>:IOPerator</code> | 743 |

SBUS<sb>:LIN:FILTer:BIT <Frame>,<Field>,<Bit>

SBUS<sb>:LIN:FILTer:FRAMe<fr>:FLD<fl>:BIT <BitState>

Sets the operator for the data pattern in the selected field of the selected frame.

Suffix:

`<sb>` 1...4, index of the serial bus

<fr> index of the frame

<fl> index of the field

Parameters:

<BitState> ONE | ZERO

*RST: ZERO

Usage: Asynchronous command

Manual operation: See "Edit" on page 372

SBUS<sb>:LIN:FILTER:DMAX <Frame>,<Field>,<Data>

SBUS<sb>:LIN:FILTER:FRAME<fr>:FLD<fl>:DMAX <Data_Max>

Sets the end value of a data pattern range if the operator is set to INRange or OORANGE.

Suffix:

<sb> 1...4, index of the serial bus

<fr> index of the frame

<fl> index of the field

Parameters:

<Data_Max>

Usage: Asynchronous command

Manual operation: See "Edit" on page 372

SBUS<sb>:LIN:FILTER:DMIN <Frame>,<Field>,<Data>

SBUS<sb>:LIN:FILTER:FRAME<fr>:FLD<fl>:DMIN <Data_Min>

Specifies the data pattern, or sets the start value of a data pattern range.

Suffix:

<sb> 1...4, index of the serial bus

<fr> index of the frame

<fl> index of the field

Parameters:

<Data_Min>

Usage: Asynchronous command

Manual operation: See "Edit" on page 372

SBUS<sb>:LIN:FILTER:DOPerator <Frame>,<Field>,<Operator>

SBUS<sb>:LIN:FILTER:FRAME<fr>:FLD<fl>:DOPerator <Data_Operator>

Sets the operator for the data pattern in the selected field of the selected frame.

Suffix:

<sb> 1...4, index of the serial bus
 <fr> index of the frame
 <fl> index of the field

Parameters:

<Data_Operator> EQUal | NEQual | LTHan | LETHan | GTHan | GETHan |
 INRange | OORange
 *RST: EQUal

Usage: Asynchronous command

Manual operation: See "Edit" on page 372

SBUS<sb>:LIN:FILTER:ERENable <ErrorName>,<Enabler>

SBUS<sb>:LIN:FILTER:ERRor<n>:ENABLE <Enable>

Defines the error type to be filtered on.

Suffix:

<sb> 1...4, index of the serial bus
 <n> index of the error

Parameters:

<Enable> ON | OFF
 *RST: ON

Usage: Asynchronous command

Manual operation: See "Error type" on page 373

SBUS<sb>:LIN:FILTER:FIENable <Frame>,<Field>,<Enabler>

SBUS<sb>:LIN:FILTER:FRAME<fr>:FLD<fl>:ENABLE <CondEnabler>

Enables or disables the checking condition for the selected field of the selected frame.

Suffix:

<sb> 1...4, index of the serial bus
 <fr> index of the frame
 <fl> index of the field

Parameters:

<CondEnabler> ON | OFF
 *RST: OFF

Usage: Asynchronous command

Manual operation: See "Edit" on page 372

SBUS<sb>:LIN:FILTER:FREnable <Frame>,<Enabler>

SBUS<sb>:LIN:FILTER:FRAME<fr>:ENABLE <Enable>

Enables the filtering on LIN frames. Only the frames that match the selected filter conditions are displayed.

Suffix:

<sb> 1...4, index of the serial bus

<fr> index of the frame

Parameters:

<Enable> ON | OFF

*RST: ON

Usage: Asynchronous command

Manual operation: See "[Frame type](#)" on page 371

SBUS<sb>:LIN:FILTER:IMAX <Frame>,<Field>,<Data>

SBUS<sb>:LIN:FILTER:FRAME<fr>:FLD<fl>:IMAX <Index_Max>

Sets the end value of an index range if the operator is set to `INRange`.

Suffix:

<sb> 1...4, index of the serial bus

<fr> index of the frame

<fl> index of the field

Parameters:

<Index_Max> Range: 1 to 65535

Increment: 1

*RST: 65535

Usage: Asynchronous command

Manual operation: See "[Edit](#)" on page 372

SBUS<sb>:LIN:FILTER:IMIN <Frame>,<Field>,<Data>

SBUS<sb>:LIN:FILTER:FRAME<fr>:FLD<fl>:IMIN <Index_Min>

Specifies the index, or sets the start value of an index range.

Suffix:

<sb> 1...4, index of the serial bus

<fr> index of the frame

<fl> index of the field

Parameters:

<Index_Min> Range: 1 to 65535

Increment: 1

*RST: 1

Usage: Asynchronous command

Manual operation: See "Edit" on page 372

SBUS<sb>:LIN:FILTER:IOperator <Frame>,<Field>,<Operator>
SBUS<sb>:LIN:FILTER:FRAME<fr>:FLD<fl>:IOperator <Index_Operator>

Sets the operator for the index in the selected field of the selected frame.

Suffix:

<sb> 1...4, index of the serial bus

<fr> index of the frame

<fl> index of the field

Parameters:

<Index_Operator> EQUal | INRange | RANGE

*RST: INRange

Usage: Asynchronous command

Manual operation: See "Edit" on page 372

17.16.6.4 Decode results

The following chapter describes the commands used for querying the results of the LIN decoding.

| | |
|--|-----|
| SBUS<sb>:LIN:FCOunt? | 743 |
| SBUS<sb>:LIN:FRAME<fr>:BITRate? | 744 |
| SBUS<sb>:LIN:FRAME<fr>:BYTE<o>:STATe? | 744 |
| SBUS<sb>:LIN:FRAME<fr>:BYTE<o>:VALue? | 744 |
| SBUS<sb>:LIN:FRAME<fr>:BYTE<o>:COUnT? | 745 |
| SBUS<sb>:LIN:FRAME<fr>:BYTE<o>:FVALue? | 745 |
| SBUS<sb>:LIN:FRAME<fr>:BYTE<o>:LABel? | 745 |
| SBUS<sb>:LIN:FRAME<fr>:CSValue? | 746 |
| SBUS<sb>:LIN:FRAME<fr>:DATA? | 746 |
| SBUS<sb>:LIN:FRAME<fr>:IDPValue? | 746 |
| SBUS<sb>:LIN:FRAME<fr>:IDSTate? | 747 |
| SBUS<sb>:LIN:FRAME<fr>:IDValue? | 747 |
| SBUS<sb>:LIN:FRAME<fr>:STARt? | 747 |
| SBUS<sb>:LIN:FRAME<fr>:STATus? | 748 |
| SBUS<sb>:LIN:FRAME<fr>:STOP? | 748 |
| SBUS<sb>:LIN:FRAME<fr>:PIDentifier? | 748 |

SBUS<sb>:LIN:FCOunt?

Returns the number of decoded frames.

Suffix:

<sb> 1...4, index of the serial bus

Return values:

<Count> Total number of decoded frames.

Usage:

Query only
Asynchronous command

SBUS<sb>:LIN:FRAMe<fr>:BITRate?

Returns the primary bit rate.

Suffix:

<sb> 1...4, index of the serial bus

<fr> index of the frame

Return values:

<PrimaryBitRate> Range: 0 to 100000000000
Increment: 1
*RST: 0
Default unit: bps

Usage:

Query only
Asynchronous command

SBUS<sb>:LIN:FRAMe<fr>:BYTE<o>:STATE?

Returns the state of the specified byte.

Suffix:

<sb> 1...4, index of the serial bus

<fr> index of the frame

<o> index of the byte

Return values:

<FrameByteState> OK | WAKeup | CHCKsum | PRERror | STERror | SYERror |
LNERror | UNK | INComplete
*RST: OK

Usage:

Query only
Asynchronous command

SBUS<sb>:LIN:FRAMe<fr>:BYTE<o>:VALue?

Returns the value of the specified byte.

Suffix:

<sb> 1...4, index of the serial bus

<fr> index of the frame

<o> index of the byte

Return values:

<FrameByteValue> Range: 0 to 18446744073709551615
Increment: 1
*RST: 0

Usage:

Query only
Asynchronous command

SBUS<sb>:LIN:FRAMe<fr>:BYTE<o>:COUNT?

Returns the number of bytes in the specified frame.

Suffix:

<sb> 1...4, index of the serial bus
<fr> index of the frame
<o> index of the byte

Return values:

<Count>

Usage:

Query only
Asynchronous command

SBUS<sb>:LIN:FRAMe<fr>:BYTE<o>:FVALue?

Returns the formatted value of the specified byte.

Suffix:

<sb> 1...4, index of the serial bus
<fr> index of the frame
<o> index of the byte

Return values:

<FormattedValue>

Usage:

Query only
Asynchronous command

SBUS<sb>:LIN:FRAMe<fr>:BYTE<o>:LABel?

Returns the label of the bytes in the specified frame.

Suffix:

<sb> 1...4, index of the serial bus
<fr> index of the frame
<o> index of the byte

Return values:

<Label>

Usage: Query only
Asynchronous command

SBUS<sb>:LIN:FRAME<fr>:CSValue?

Returns the checksum value of the specified frame.

Suffix:

<sb> 1...4, index of the serial bus

<fr> index of the frame

Return values:

<ChecksumValue> Range: 0 to 255
Increment: 1
*RST: 0

Usage: Query only
Asynchronous command

SBUS<sb>:LIN:FRAME<fr>:DATA?

Returns the data bytes of the specified frame.

Suffix:

<sb> 1...4, index of the serial bus

<fr> index of the frame

Example:

```
BUS:LIN:FRAME4:DATA?
<-- 4,118,39,71,123
```

Usage: Query only
Asynchronous command

SBUS<sb>:LIN:FRAME<fr>:IDPValue?

Returns the value of the identifier parity bits of the selected frame.

Suffix:

<sb> 1...4, index of the serial bus

<fr> index of the frame

Return values:

<IdtfParVal> Range: 0 to 3
Increment: 1
*RST: 0

Usage: Query only
Asynchronous command

SBUS<sb>:LIN:FRAMe<fr>:IDStAtE?

Returns the identifier state of the selected frame.

Suffix:

<sb> 1...4, index of the serial bus
<fr> index of the frame

Return values:

<IdtfSt> OK | UART | CHCKsum | VERS | LENer | SPERror | PRERror |
SYERror | WAKeup | CPERror | INComplete | INER
*RST: OK

Usage: Query only
Asynchronous command

SBUS<sb>:LIN:FRAMe<fr>:IDValue?

Returns the identifier value of the selected frame.

Suffix:

<sb> 1...4, index of the serial bus
<fr> index of the frame

Return values:

<IdtfVal> Range: 0 to 63
Increment: 1
*RST: 0

Usage: Query only
Asynchronous command

SBUS<sb>:LIN:FRAMe<fr>:START?

Returns the start time of the selected frame.

Suffix:

<sb> 1...4, index of the serial bus
<fr> index of the frame

Return values:

<FrameStart> Range: -1E+26 to 1E+26
Increment: 1E-10
*RST: 0
Default unit: s

Usage: Query only
Asynchronous command

SBUS<sb>:LIN:FRAMe<fr>:STATus?

Returns the overall state of the selected frame.

Suffix:

<sb> 1...4, index of the serial bus
<fr> index of the frame

Return values:

<FrameState> OK | WAKeup | CHCKsum | PRERror | STERror | SYERror |
LNERror | UNK | INComplete

WAKeup: wake-up frame.

CHCKsum: checksum error

PRERror: parity error in identifier

STERror: stop error

SYERror: synchronization error

LNERror: unexpected length

UNK: unknown error

*RST: OK

Usage:

Query only
Asynchronous command

SBUS<sb>:LIN:FRAMe<fr>:STOP?

Returns the stop time of the selected frame.

Suffix:

<sb> 1...4, index of the serial bus
<fr> index of the frame

Return values:

<FrameStop> Range: -1E+26 to 1E+26

Increment: 1E-10

*RST: 0

Default unit: s

Usage:

Query only
Asynchronous command

SBUS<sb>:LIN:FRAMe<fr>:PIDentifier?

Returns the protected identifier of the selected frame.

Suffix:

<sb> 1...4, index of the serial bus
<fr> index of the frame

Return values:

<Protected identifier> Range: 0 to 255
 Increment: 1
 *RST: 0

Usage:

Query only
 Asynchronous command

17.17 Mixed signal option (option R&S MXO5-B1)

This chapter describes the remote commands of MSO option R&S MXO5-B1.

Some of the commands in the following chapter are asynchronous. An overlapping or asynchronous command does not automatically finish executing before the next command starts executing. If overlapping commands must be executed in a defined order, e.g. to avoid wrong measurement results, they must be serviced sequentially.

To prevent an overlapping execution of commands, one of the commands *OPC, *OPC? or *WAI can be used after the command or a command set.

For more information, see:

- www.rohde-schwarz.com/rc-via-scpj, chapter "Command sequence and synchronization"

17.17.1 Digital channels

All DIGital: commands affect only the settings of the first MSO bus (Logic1). The settings of all other logic groups (Logic 2, 3,4) remain unchanged.

| | |
|----------------------------|-----|
| DIGital<m>:LABel..... | 749 |
| DIGital<m>:SIZE..... | 750 |
| DIGital<m>:SKEW..... | 750 |
| DIGital<m>:STATe..... | 750 |
| DIGital<m>:TECHnology..... | 751 |
| DIGital<m>:THCoupling..... | 751 |
| DIGital<m>:THReshold..... | 751 |

DIGital<m>:LABel <Label>

Sets a name for the indicated digital channel. The name is displayed in the diagram.

The setting affects only the settings of the first MSO bus (Logic1).

You can set the label for all buses with `PBUS<pb>:BIT<n>:LABel`

Suffix:

<m> 0..15
 Selects the digital channel.

Parameters:

<Label> String containing the channel name

Usage: Asynchronous command

DIGital<m>:SIZE <Size>

Suffix:

<m> 0..15
The suffix is irrelevant.

Parameters:

<Size>

Usage: Asynchronous command

DIGital<m>:SKEW <Skew>

Sets an individual delay for each digital channel to time-align it with other digital channels. The skew value compensates delays that are known from the circuit specifics or caused by the different length of cables.

The setting affects only the settings of the first MSO bus (Logic1).

You can set the skew for all buses with `PBUS<pb>:BIT<n>:SKEW`.

Suffix:

<m> 0..15
Selects the digital channel.

Parameters:

<Skew>

Usage: Asynchronous command

DIGital<m>:STATe <State>

Enables or disables the indicated digital channel, displays it, and enables the Logic 1 if the bus was disabled.

If another active bus already uses the selected digital channel, the instrument disables the other bus to avoid conflicts.

For Logic 1, the `DIG : : STAT` command has the same effect as `PBUS<pb>:STATe`. To enable digital channels for buses 2, 3 and 4, use the `PBUS:BIT[:STAT]` command.

Suffix:

<m> 0..15
Selects the digital channel.

Parameters:

<State> ON | OFF

Usage: Asynchronous command

DIGital<m>:TECHnology <Technology>

Selects the threshold voltage for various types of integrated circuits and applies it to all digital channels.

The setting affects only the settings of the first MSO bus (Logic1).

You can set the technology value for all buses with [PBUS<pb>:TECHnology](#).

Suffix:

<m> 0..15
The suffix is irrelevant.

Parameters:

<Technology> V15 | V25 | V165 | V125 | V09 | VM13 | V38 | V20 | V0 | MANual
See [PBUS<pb>:TECHnology](#).

Usage: Asynchronous command

DIGital<m>:THCoupling <State>

Sets the threshold and the hysteresis for all digital channels of Logic1 to the same value.

Suffix:

<m> 0..15
The suffix is irrelevant.

Parameters:

<State> ON | OFF

Usage: Asynchronous command

DIGital<m>:THReshold <Value>

Sets the logical threshold for the channel group to which the indicated digital channel belongs.

The setting affects only the settings of the first MSO bus (Logic1).

You can set the threshold for all buses with [PBUS<pb>:TECHnology](#) or [PBUS<pb>:THReshold<n>](#)

See also: [DIGital<m>:THCoupling](#) on page 751

Suffix:

<m> 0..15
Number of the digital channel.
Channel groups: 0..3; 4..7; 8..11; 12..15

Parameters:

<Value>

Usage: Asynchronous command

17.17.2 Logic configuration

The following commands configure the four logic groups of R&S MXO5-B1.

| | |
|-----------------------------------|-----|
| PBUS<pb>:BIT<n>:LABel..... | 752 |
| PBUS<pb>:BIT<n>:SKEW..... | 752 |
| PBUS<pb>:BIT<n>[:STATe]..... | 753 |
| PBUS<pb>:CLEar..... | 753 |
| PBUS<pb>:CLOCK..... | 753 |
| PBUS<pb>:CLON..... | 754 |
| PBUS<pb>:CLSLope..... | 754 |
| PBUS<pb>:DIGSignals:POSition..... | 754 |
| PBUS<pb>:DIGSignals:SCALE..... | 755 |
| PBUS<pb>:DISPlay:SHBU..... | 755 |
| PBUS<pb>:DISPlay:SHDI..... | 755 |
| PBUS<pb>:HYSTeresis<n>..... | 756 |
| PBUS<pb>:POSition..... | 756 |
| PBUS<pb>:SCALE..... | 756 |
| PBUS<pb>:SKEW..... | 757 |
| PBUS<pb>:STATe..... | 757 |
| PBUS<pb>:TECHnology..... | 757 |
| PBUS<pb>:THCoupling..... | 758 |
| PBUS<pb>:THReshold<n>..... | 758 |

PBUS<pb>:BIT<n>:LABel <Label>

Sets a name for the indicated digital channel. The name is displayed in the diagram.

Suffix:

| | |
|------|--|
| <pb> | 1...4, index of the logic group |
| <n> | 0..15
Selects the bit of the bus word. Each bit corresponds to a digital channel. |

Parameters:

| | |
|---------|------------------------------------|
| <Label> | String containing the channel name |
|---------|------------------------------------|

Usage: Asynchronous command

PBUS<pb>:BIT<n>:SKEW <Skew>

Sets an individual delay for each digital channel to time-align it with other digital channels.

The skew value compensates delays that are known from the circuit specifics or caused by the different length of cables. The skew between the probe boxes of the digital channels and the probe connectors of the analog channels is automatically aligned by the instrument.

Suffix:

| | |
|------|---------------------------------|
| <pb> | 1...4, index of the logic group |
|------|---------------------------------|

Mixed signal option (option R&S MXO5-B1)

<n> 0..15
Selects the bit of the bus word. Each bit corresponds to a digital channel.

Parameters:

<Skew> Range: -2E-07 to 2E-07
Increment: 2E-10
*RST: 0
Default unit: s

Usage: Asynchronous command

Manual operation: See "[D0-D15](#)" on page 384

PBUS<pb>:BIT<n>[:STATE] <Assigned>

Enables the selected logic group. The corresponding signal icon appears on the signal bar.

If another active bus already uses the selected digital channel, the instrument disables the other bus to avoid conflicts.

Suffix:

<pb> 1...4, index of the logic group

<n> 0..15
Selects the bit of the bus word. Each bit corresponds to a digital channel.

Parameters:

<Assigned> ON | OFF
*RST: OFF

Usage: Asynchronous command

PBUS<pb>:CLEAr

Removes all assigned digital channels from the bus.

Suffix:

<pb> 1...4, index of the logic group

Usage: Setting only
Asynchronous command

PBUS<pb>:CLOCK <ClockSource>

Selects the digital channel used as clock.

Suffix:

<pb> 1 | 2
Selects the logic. The clocked bus is available on Logic 1 and 2.

Mixed signal option (option R&S MXO5-B1)

Parameters:

<ClockSource> D0 | D1 | D2 | D3 | D4 | D5 | D6 | D7 | D8 | D9 | D10 | D11 | D12 |
D13 | D14 | D15
Clock channel
*RST: D0

Usage: Asynchronous command

Manual operation: See "[Clock source](#)" on page 382

PBUS<pb>:CLON <Clocked>

Defines if the bus is a clocked bus - one of the digital channels serves as clock of the bus.

Suffix:

<pb> 1 | 2
Selects the logic. The clocked bus is available on Logic 1 and 2.

Parameters:

<Clocked> ON | OFF
*RST: OFF

Usage: Asynchronous command

Manual operation: See "[Bus clocked](#)" on page 382

PBUS<pb>:CLSlope <ClockSlope>

Selects the slope of the clock signal at which all digital channels of the bus are analyzed.

Suffix:

<pb> 1 | 2
Selects the logic. The clocked bus is available on Logic 1 and 2.

Parameters:

<ClockSlope> POSitive | NEGative | EITHer
*RST: POSitive

Usage: Asynchronous command

Manual operation: See "[Clock slope](#)" on page 382

PBUS<pb>:DIGSignals:POSition <DigChanPosition>

Sets the vertical position of all active digital channels.

Suffix:

<pb> 1...4, index of the logic group

Parameters:

<DigChanPosition> Range: 0 to 4294967295
 Increment: 1
 *RST: 0

Usage: Asynchronous command

PBUS<pb>:DIGSignals:SCALE <RelativeHeight>

Sets the size of the display that is used by each active digital signal.

Suffix:

<pb> 1...4, index of the logic group

Parameters:

<RelativeHeight> Range: 2 to 100
 Increment: 0.5
 *RST: 6.25
 Default unit: %

Usage: Asynchronous command

PBUS<pb>:DISPlay:SHBU <ShowBus>

If enabled, the resulting bus signal and bus values are displayed in the diagram.

Suffix:

<pb> 1...4, index of the logic group

Parameters:

<ShowBus> ON | OFF
 *RST: OFF

Usage: Asynchronous command

Manual operation: See "[Show bus](#)" on page 381

PBUS<pb>:DISPlay:SHDI <ShwDigSigns>

If enabled, the selected digital channels are shown in the diagram. Each channel is displayed as a logic signal.

Suffix:

<pb> 1...4, index of the logic group

Parameters:

<ShwDigSigns> ON | OFF
 *RST: OFF

Usage: Asynchronous command

Manual operation: See "[Show dig. signals](#)" on page 379

PBUS<pb>:HYSTerisis<n> <Hysteresis>

Defines the size of the hysteresis for the respective channels.

Suffix:

| | |
|------|---|
| <pb> | 1..4, index of the logic group |
| <n> | 1..4
Selects the channel group:
1 = digital channels 0..3
2 = digital channels 4..7
3 = digital channels 8..11
4 = digital channels 12..15 |

Parameters:

| | |
|--------------|--|
| <Hysteresis> | MAXimum ROBust NORMal

MAXIMUM = MAXimum
Maximum value that is possible and useful for the signal and its settings

ROBUST = ROBust
Different hysteresis values for falling and rising edges to avoid an undefined state of the trigger system.

NORMAL = NORMal
The instrument sets a value suitable for the signal and its settings. |
|--------------|--|

Usage: Asynchronous command

Manual operation: See "[Hysteresis](#)" on page 380

PBUS<pb>:POSition <YPosition>

Sets the position of the indicated logic group waveform.

Suffix:

| | |
|------|--------------------------------|
| <pb> | 1..4, index of the logic group |
|------|--------------------------------|

Parameters:

| | |
|-------------|--|
| <YPosition> | Range: 0 to 100
Increment: 0.1
*RST: 50
Default unit: % |
|-------------|--|

Usage: Asynchronous command

PBUS<pb>:SCALe <RelativeHeight>

Sets the size of the display that is used by the indicated logic group waveform.

Suffix:

| | |
|------|--------------------------------|
| <pb> | 1..4, index of the logic group |
|------|--------------------------------|

Suffix:

<pb> 1...4, index of the logic group

Parameters:

<Technology> V15 | V25 | V165 | V125 | V09 | VM13 | V38 | V20 | V0 | MANual
 V15: TTL
 V25: CMOS 5.0 V
 V165: CMOS 3.3 V
 V125: CMOS 2.5 V
 V09: CMOS 1.85 V
 VM13: ECL, -1.3 V
 V38: PECL
 V20: LVPECL
 V0: Ground
 MANual: Set a user-defined threshold value with [DIGital<m>: THReshold](#) on page 751.
 *RST: V165

Usage: Asynchronous command

Manual operation: See "[Technology, Threshold](#)" on page 380

PBUS<pb>:THCoupling <LevelCoupling>

Sets the threshold and the hysteresis for all digital channels and all buses to the same value.

For Logic 1, the command [DIGital<m>: THCoupling](#) has the same effect.

Suffix:

<pb> 1...4, index of the logic group

Parameters:

<LevelCoupling> ON | OFF
 *RST: ON

Usage: Asynchronous command

Manual operation: See "[Level coupling](#)" on page 380

PBUS<pb>:THReshold<n> <Threshold>

Sets the logical threshold for the indicated channel group.

Alternatively you can use the following commands:

- To select from a list of predefined technologies: [PBUS<pb>:TECHnology](#)
- For logic 1: [DIGital<m>: THReshold](#)

See also [DIGital<m>: THCoupling](#) on page 751.

Suffix:

<pb> 1...4, index of the logic group

<n> 1..4
 Selects the channel group:
 1 = digital channels 0..3;
 2 = digital channels 4..7
 3 = digital channels 8..11
 4 = digital channels 12..15

Parameters:
 <Threshold>

Usage: Asynchronous command

Manual operation: See "[Technology, Threshold](#)" on page 380

17.17.3 MSO data

The remote data transfer from the instrument to the controlling computer is performed using the following commands:

| | |
|---------------------------|-----|
| DIGital<m>:DATA:HEADer? | 759 |
| DIGital<m>:DATA[:VALues]? | 759 |
| PBUS<pb>:DATA:FORMat | 760 |
| PBUS<pb>:DATA:HEADer? | 760 |
| PBUS<pb>:DATA[:VALues]? | 761 |

DIGital<m>:DATA:HEADer?

Returns the header of digital channel data

Table 17-7: Header data

| Position | Meaning | Example |
|----------|--|-------------------|
| 1 | XStart, acquisition time before trigger, in s | -5E-008 = - 50 ns |
| 2 | XStop, acquisition time after trigger, in s | 5E-008 = 50 ns |
| 3 | Record length of the waveform in Samples | 1000 |
| 4 | Number of values per sample interval. For digital data, the result is 1. | 1 |

Suffix:

<m> 0..15
 Selects the digital channel.

Usage: Query only
 Asynchronous command

DIGital<m>:DATA[:VALues]? [<Offset>],[<Length>]

Returns the data of the indicated digital channel for transmission from the instrument to the controlling computer. The data can be used in MATLAB, for example.

Without parameters, the complete waveform is retrieved. Using the offset and length parameters, data can be retrieved in smaller portions, which makes the command faster. If you send only one parameter, it is interpreted as offset, and the data is retrieved from offset to the end of the waveform.

Suffix:

<m> 0..15
Selects the digital channel.

Query parameters:

<Offset> Number of offset values, which are ignored in the data transfer.
<Length> Number of values to be retrieved.

Return values:

<Data> List of values according to the format and content settings.

Usage:

Query only
Asynchronous command

PBUS<pb>:DATA:FORMat <DataFormat>

Sets the data format of bus values, which are displayed in the decode table and on the comb bus display.

It also sets the format for the number representation for remote data transfer with [PBUS<pb>:DATA\[:VALues\]?](#).

Suffix:

<pb> 1...4, index of the logic group

Parameters:

<DataFormat> HEX | OCT | BIN | ASCII | ASCii | SIGN | USIG
*RST: HEX

Usage: Asynchronous command

Manual operation: See "[Data format](#)" on page 381

PBUS<pb>:DATA:HEADer?

Returns the header data of the indicated bus.

For a detailed description, see [DIGital<m>:DATA:HEADer?](#).

Suffix:

<pb> 1...4, index of the logic group

Usage:

Query only
Asynchronous command

Manual operation: See "[Data format](#)" on page 381

PBUS<pb>:DATA[:VALues]? [<Offset>],[<Length>]

Returns the data of the indicated logic.

Requirements:

- `PBUS<pb>:STATe` is set to ON.
- `PBUS<pb>:DISPlay:SHBU` is set to ON.
- A number format is set with `PBUS<pb>:DATA:FORMat`.

Suffix:

<pb> 1...4, index of the logic group

Query parameters:

[<Offset>] Number of offset waveform points to be skipped.
Range: 0 to m. Limit: $n + m \leq$ record length

[<Length>] Number of waveform points to be retrieved.
Range: 1 to n. Limit: $n + m \leq$ record length

Return values:

<Data> List of values according to the format and content settings.

Example:

```
PBUS:STAT ON
PBUS:DISP:SHBU ON
PBUS:DISP:BTYP COMB
PBUS:DATA:FORMat HEX
PBUS:DATA:VAL?
```

Usage:

Query only
Asynchronous command

Manual operation: See "[Data format](#)" on page 381

17.18 Waveform generator (option R&S MXO5-B6)

This chapter describes the remote commands of the waveform generator.

The instrument preset does not affect the generator settings. Each generator has its own preset: `WGENerator<wg>:PRESet`.

Some of the commands in the following chapter are asynchronous. An overlapping or asynchronous command does not automatically finish executing before the next command starts executing. If overlapping commands must be executed in a defined order, e.g. to avoid wrong measurement results, they must be serviced sequentially.

To prevent an overlapping execution of commands, one of the commands `*OPC`, `*OPC?` or `*WAI` can be used after the command or a command set.

For more information, see:

- www.rohde-schwarz.com/rc-via-scpi, chapter "Command sequence and synchronization"

17.18.1 Waveform generator setup

17.18.1.1 General settings

| | |
|--|-----|
| WGENerator<wg>:FREQUency..... | 762 |
| WGENerator<wg>:FUNCTion:PULSe[:WIDTh]..... | 762 |
| WGENerator<wg>:FUNCTion:RAMP[:SYMMetry]..... | 763 |
| WGENerator<wg>:FUNCTion[:SElect]..... | 763 |
| WGENerator<wg>:FUNCTion[:SQUare]:DCYCLE..... | 763 |
| WGENerator<wg>:OUTPut[:LOAD]..... | 764 |
| WGENerator<wg>:PERiod..... | 764 |
| WGENerator<wg>:PRESet..... | 764 |
| WGENerator<wg>:VOLTag:e:DCLevel..... | 765 |
| WGENerator<wg>:VOLTag:e:HIGH..... | 765 |
| WGENerator<wg>:VOLTag:e:INVersion..... | 765 |
| WGENerator<wg>:VOLTag:e:LOW..... | 765 |
| WGENerator<wg>:VOLTag:e:OFFSet..... | 766 |
| WGENerator<wg>:VOLTag:e[:VPP]..... | 766 |
| WGENerator<wg>[:ENABLE]..... | 766 |

WGENerator<wg>:FREQUency <Frequency>

Sets the frequency of the waveform.

Suffix:

<wg> 1...2, index of the waveform generator

Parameters:

<Frequency> Range: 0.001 to 100000000
 Increment: 1
 *RST: 10000000
 Default unit: Hz

Usage: Asynchronous command

Manual operation: See "[Frequency](#)" on page 392

WGENerator<wg>:FUNCTion:PULSe[:WIDTh] <PulseWidth>

Sets the pulse width, the pulse duration of the generated pulse waveform.

Suffix:

<wg> 1...2, index of the waveform generator

Parameters:

<PulseWidth> Range: 1.65E-08 to 90000
 Increment: 1
 *RST: 5E-07
 Default unit: s

Usage: Asynchronous command

Manual operation: See ["Pulse width"](#) on page 394

WGENerator<wg>:FUNction:RAMP[:SYMMetry] <RampSymmetry>

Sets the symmetry of a ramp waveform, the percentage of time the waveform is rising. By changing the symmetry of the ramp, you can create, for example, triangular waveforms.

Suffix:

<wg> 1...2, index of the waveform generator

Parameters:

<RampSymmetry> Range: 0 to 100
 Increment: 1
 *RST: 50
 Default unit: %

Usage: Asynchronous command

Manual operation: See ["Symmetry"](#) on page 393

WGENerator<wg>:FUNction[:SElect] <FunctionType>

Selects the type of waveform to be generated.

Suffix:

<wg> 1...2, index of the waveform generator

Parameters:

<FunctionType> SINusoid | SQUare | RAMP | DC | PULSe | SINC | CARDiac |
 GAUSs | LORNTz | EXPRise | EXPFall | ARBitrary
 SINC: Cardinal sine
 *RST: SINusoid

Usage: Asynchronous command

Manual operation: See ["Function type"](#) on page 387

WGENerator<wg>:FUNction[:SQUare]:DCYCLE <SquareDutyCycle>

Sets the duty cycle for the pulse function.

Suffix:

<wg> 1..2

Parameters:

<SquareDutyCycle> Range: 0.01 to 99.99
 Increment: 1
 *RST: 50
 Default unit: %

Usage: Asynchronous command

Manual operation: See ["Duty cycle"](#) on page 393

WGENerator<wg>:OUTPut[:LOAD] <Load>

Select the user load, the load of the DUT at its connection.

Suffix:

<wg> 1..2

Parameters:

<Load> FIFTy | HIZ
FIFTy: 50Ω
HIZ: High-Z (high input impedance)
*RST: HIZ

Usage: Asynchronous command

Manual operation: See ["User load"](#) on page 393

WGENerator<wg>:PERiod <Period>

Sets the period of the pulse waveform, if `WGENerator<wg>:FUNCTION[:SElect]` is set to `PULSe`.

Suffix:

<wg> 1..2

Parameters:

<Period> Range: 1E-08 to 1000
Increment: 1
*RST: 1E-06
Default unit: s

Usage: Asynchronous command

Manual operation: See ["Period"](#) on page 394

WGENerator<wg>:PRESet

Presets the generator to a default setup. The default includes the following settings:

- "Function type" = "Sine"
- "Frequency" = "1 MHz"
- "Amplitude" = "1 Vpp"

Suffix:

<wg> 1..2

Usage:

Setting only
Asynchronous command

Manual operation: See ["Default setup"](#) on page 394

WGENerator<wg>:VOLTage:DCLevel <DCLevel>

Sets the level for the DC signal, if **WGENerator<wg>:FUNCTION[:SElect]** is set to DC.

Suffix:

<wg> 1..2

Parameters:

<DCLevel> Range: -5 to 5
Increment: 0.1
*RST: 0
Default unit: V

Usage: Asynchronous command

Manual operation: See "[DC level](#)" on page 394

WGENerator<wg>:VOLTage:HIGH <High>

Sets the high signal level of the output waveform.

Suffix:

<wg> 1..2

Parameters:

<High> Range: -5.99 to 6
Increment: 0.1
*RST: 0.5
Default unit: V

Usage: Asynchronous command

WGENerator<wg>:VOLTage:INVersion <Inversion>

Inverts the waveform at the offset level.

Suffix:

<wg> 1..2

Parameters:

<Inversion> ON | OFF
*RST: OFF

Usage: Asynchronous command

Manual operation: See "[Inversion](#)" on page 387

WGENerator<wg>:VOLTage:LOW <Low>

Sets the low signal level of the output waveform.

Suffix:

<wg> 1..2

Parameters:

<Low> Range: -6 to 5.99
 Increment: 0.1
 *RST: -0.5
 Default unit: V

Usage: Asynchronous command

WGENerator<wg>:VOLTage:OFFSet <Offset>

Sets the vertical offset of the generated waveform.

Suffix:

<wg> 1..2

Parameters:

<Offset> Range: -5.995 to 5.995
 Increment: 0.1
 *RST: 0
 Default unit: V

Usage: Asynchronous command

Manual operation: See "[Offset](#)" on page 393

WGENerator<wg>:VOLTage[:VPP] <Amplitude>

Sets the amplitude of the waveform.

Suffix:

<wg> 1..2

Parameters:

<Amplitude> Range: 0.01 to 12
 Increment: 0.1
 *RST: 0.4
 Default unit: Vpp

Usage: Asynchronous command

Manual operation: See "[Amplitude](#)" on page 392

WGENerator<wg>[:ENABLE] <State>

Enables the function generator.

Suffix:

<wg> 1..2

Parameters:

<State> ON | OFF
 *RST: OFF

Usage: Asynchronous command

Manual operation: See "State" on page 387

17.18.1.2 Modulation settings

| | |
|--|-----|
| WGENerator<wg>:MODulation[:STATe]..... | 767 |
| WGENerator<wg>:MODulation:AM:DCYClE..... | 767 |
| WGENerator<wg>:MODulation:AM:DEPTH..... | 768 |
| WGENerator<wg>:MODulation:AM:FREQuency..... | 768 |
| WGENerator<wg>:MODulation:AM:SYMMetry..... | 768 |
| WGENerator<wg>:MODulation:AM[:FUNCTion]..... | 769 |
| WGENerator<wg>:MODulation:CARRier:FREQuency..... | 769 |
| WGENerator<wg>:MODulation:CARRier:PERiod..... | 769 |
| WGENerator<wg>:MODulation:FM:DCYClE..... | 770 |
| WGENerator<wg>:MODulation:FM:DEVIation..... | 770 |
| WGENerator<wg>:MODulation:FM:FREQuency..... | 770 |
| WGENerator<wg>:MODulation:FM:SYMMetry..... | 771 |
| WGENerator<wg>:MODulation:FM[:FUNCTion]..... | 771 |
| WGENerator<wg>:MODulation:FSK:FONE..... | 771 |
| WGENerator<wg>:MODulation:FSK:FTWO..... | 771 |
| WGENerator<wg>:MODulation:FSK[:RATE]..... | 772 |
| WGENerator<wg>:MODulation:NDCLevel..... | 772 |
| WGENerator<wg>:MODulation:NLABsolute?..... | 772 |
| WGENerator<wg>:MODulation:NLPCent..... | 773 |
| WGENerator<wg>:MODulation:PWM:DCYClE..... | 773 |
| WGENerator<wg>:MODulation:PWM:DEPTH..... | 773 |
| WGENerator<wg>:MODulation:PWM:FREQuency..... | 774 |
| WGENerator<wg>:MODulation:PWM:SYMMetry..... | 774 |
| WGENerator<wg>:MODulation:PWM[:FUNCTion]..... | 774 |
| WGENerator<wg>:MODulation:TYPE..... | 775 |

WGENerator<wg>:MODulation[:STATe] <Modulation>

Enables or disables modulation.

Suffix:

<wg> 1..2

Parameters:

<Modulation> ON | OFF
*RST: OFF

Usage: Asynchronous command

Manual operation: See "Modulation state" on page 395

WGENerator<wg>:MODulation:AM:DCYClE <SquareDutyCycle>

Sets the duty cycle for a square waveform. The duty cycle expresses for what percentage fraction of the period, the waveform is active, i.e. the signal state is high.

Suffix:

<wg> 1..2

Parameters:

<SquareDutyCycle> Range: 10 to 90
 Increment: 1
 *RST: 50
 Default unit: %

Usage: Asynchronous command**Manual operation:** See "[Duty cycle](#)" on page 396**WGENerator<wg>:MODulation:AM:DEPTh <Depth>**

Sets the modulation depth, the percentage of the amplitude range that is used for AM modulation.

Suffix:

<wg> 1..2

Parameters:

<Depth> Range: 0 to 100
 Increment: 1
 *RST: 50
 Default unit: %

Usage: Asynchronous command**Manual operation:** See "[Depth](#)" on page 396**WGENerator<wg>:MODulation:AM:FREQuency <Frequency>**

Sets the frequency of the modulation waveform for AM frequency modulation.

Suffix:

<wg> 1..2

Parameters:

<Frequency> Range: 0.001 to 1000000
 Increment: 1
 *RST: 1000
 Default unit: Hz

Usage: Asynchronous command**Manual operation:** See "[Frequency](#)" on page 396**WGENerator<wg>:MODulation:AM:SYMMetry <RampSymmetry>**

Sets the symmetry for the AM ramp modulation waveform, the percentage of time that the waveform is rising.

Suffix:

<wg> 1..2

Parameters:

<RampSymmetry> Range: 0 to 100
 Increment: 1
 *RST: 50
 Default unit: %

Usage: Asynchronous command**Manual operation:** See "[Symmetry](#)" on page 396**WGENerator<wg>:MODulation:AM[:FUNcTion] <SignalType>**

Selects the type of the modulating signal for AM modulation.

Suffix:

<wg> 1..2

Parameters:

<SignalType> SINusoid | SQUare | RAMP
 *RST: SINusoid

Usage: Asynchronous command**Manual operation:** See "[Signal type](#)" on page 395**WGENerator<wg>:MODulation:CARRier:FREQuency <FreqCarrierAlias>**

Sets the frequency of the carrier signal for a modulation waveform.

Suffix:

<wg> 1..2

Parameters:

<FreqCarrierAlias> Range: 0.001 to 100000000
 Increment: 10
 *RST: 1000000
 Default unit: Hz

Usage: Asynchronous command**WGENerator<wg>:MODulation:CARRier:PERiod <PeriodCarrierAlias>**

Sets the period of the carrier signal for a modulation waveform.

Suffix:

<wg> 1..2

Parameters:

<PeriodCarrierAlias> Range: 1E-08 to 1000
 Increment: 1
 *RST: 1E-06
 Default unit: s

Usage: Asynchronous command

WGENerator<wg>:MODulation:FM:DCYcle <SquareDutyCycle>

Sets the duty cycle for a square waveform. The duty cycle expresses for what percentage fraction of the period, the waveform is active, i.e. the signal state is high.

Suffix:

<wg> 1..2

Parameters:

<SquareDutyCycle> Range: 10 to 90
 Increment: 1
 *RST: 50
 Default unit: %

Usage: Asynchronous command

Manual operation: See "[Duty cycle](#)" on page 396

WGENerator<wg>:MODulation:FM:DEVIation <Deviation>

Sets the frequency deviation, the maximum difference between the FM modulated signal and the carrier signal.

Suffix:

<wg> 1..2

Parameters:

<Deviation> Range: 0.001 to 10000000
 Increment: 1
 *RST: 1000
 Default unit: Hz

Usage: Asynchronous command

Manual operation: See "[Deviation](#)" on page 396

WGENerator<wg>:MODulation:FM:FREQuency <Frequency>

Sets the frequency of the modulating waveform for FM modulation.

Suffix:

<wg> 1..2

Parameters:

<Frequency> Range: 0.001 to 1000000
 Increment: 1
 *RST: 1000
 Default unit: Hz

Usage: Asynchronous command

Manual operation: See "[Frequency](#)" on page 396

WGENerator<wg>:MODulation:FM:SYMMetry <RampSymmetry>

Sets the symmetry for the FM ramp modulation waveform, the percentage of time that the waveform is rising.

Suffix:

<wg> 1..2

Parameters:

<RampSymmetry> Range: 0 to 100
 Increment: 1
 *RST: 50
 Default unit: %

Usage: Asynchronous command

Manual operation: See "[Symmetry](#)" on page 396

WGENerator<wg>:MODulation:FM[:FUNCTION] <SignalType>

Selects the type of the modulating signal for FM modulation.

Suffix:

<wg> 1..2

Parameters:

<SignalType> SINusoid | SQUare | RAMP
 *RST: SINusoid

Usage: Asynchronous command

Manual operation: See "[Signal type](#)" on page 395

WGENerator<wg>:MODulation:FSK:FONE <Frequency1>**WGENerator<wg>:MODulation:FSK:FTWO <Frequency2>**

Sets the frequency of the first /second signal in FSK modulated signal.

Suffix:

<wg> 1..2

Parameters:

<Frequency2> Range: 0.001 to 100000000
 Increment: 1
 *RST: 1000
 Default unit: Hz

Usage: Asynchronous command

Manual operation: See "[Frequency 1/Frequency 2](#)" on page 396

WGENerator<wg>:MODulation:FSK[:RATE] <Rate>

Sets the frequency at which signal switches between [WGENerator<wg>:MODulation:FSK:FONE](#) and [WGENerator<wg>:MODulation:FSK:FTWO](#).

Suffix:

<wg> 1..2

Parameters:

<Rate> Range: 0.001 to 1000000
 Increment: 1
 *RST: 1000
 Default unit: Hz

Usage: Asynchronous command

Manual operation: See "[FSK rate](#)" on page 397

WGENerator<wg>:MODulation:NDCLevel <LevelDC>

Sets the DC noise level, if [WGENerator<wg>:FUNCTION\[:SElect\]](#) is set to DC.

Suffix:

<wg> 1..2

Parameters:

<LevelDC> Range: 0 to 10
 Increment: 0.1
 *RST: 0
 Default unit: Vpp

Usage: Asynchronous command

Manual operation: See "[Noise level for DC](#)" on page 394

WGENerator<wg>:MODulation:NLABsolute?

Queries the level of the noise in volts.

Suffix:

<wg> 1...2, index of the waveform generator

Return values:

<LevAbs> Range: 0 to 12
 Increment: 0.1
 *RST: 0
 Default unit: Vpp

Usage:

Query only
 Asynchronous command

WGENerator<wg>:MODulation:NLPCent <LevelPct>

Sets the level of the noise in percentage of the set "Amplitude" output of the signal.

Suffix:

<wg> 1..2

Parameters:

<LevelPct> Range: 0 to 100
 Increment: 1
 *RST: 0
 Default unit: %

Usage:

Asynchronous command

Manual operation: See ["Noise level in %"](#) on page 393

WGENerator<wg>:MODulation:PWM:DCYCLE <SquareDutyCycle>

Sets the duty cycle for a square waveform. The duty cycle expresses for what percentage fraction of the period, the waveform is active, i.e. the signal state is high.

Suffix:

<wg> 1..2

Parameters:

<SquareDutyCycle> Range: 10 to 90
 Increment: 1
 *RST: 50
 Default unit: %

Usage:

Asynchronous command

Manual operation: See ["Duty cycle"](#) on page 396

WGENerator<wg>:MODulation:PWM:DEPTH <Depth>

Sets the modulation depth, the percentage of the amplitude range that is used for PWM modulation.

Suffix:

<wg> 1..2

Parameters:

<Depth> Range: 0 to 100
 Increment: 1
 *RST: 50
 Default unit: %

Usage: Asynchronous command

Manual operation: See "[Modulation depth](#)" on page 396

WGENerator<wg>:MODulation:PWM:FREQuency <Frequency>

Sets the frequency of the modulating waveform for PWM modulation.

Suffix:

<wg> 1..2

Parameters:

<Frequency> Range: 0.001 to 1000000
 Increment: 1
 *RST: 1000
 Default unit: Hz

Usage: Asynchronous command

Manual operation: See "[Frequency](#)" on page 396

WGENerator<wg>:MODulation:PWM:SYMMetry <RampSymmetry>

Sets the symmetry for the PWM ramp modulation waveform, the percentage of time that the waveform is rising.

Suffix:

<wg> 1..2

Parameters:

<RampSymmetry> Range: 0 to 100
 Increment: 1
 *RST: 50
 Default unit: %

Usage: Asynchronous command

Manual operation: See "[Symmetry](#)" on page 396

WGENerator<wg>:MODulation:PWM[:FUNctioN] <SignalType>

Selects the type of the modulating signal for PWM modulation.

Suffix:

<wg> 1..2

Parameters:

<SignalType> SINusoid | SQUare | RAMP
 *RST: SINusoid

Usage: Asynchronous command

Manual operation: See "[Signal type](#)" on page 395

WGENerator<wg>:MODulation:TYPE <ModulationType>

Selects the modulation type, which defines how the carrier signal is modified.

Suffix:

<wg> 1..2

Parameters:

<ModulationType> NONE | AM | FM | PWM | ASK | FSK
 *RST: AM

Usage: Asynchronous command

Manual operation: See "[Modulation type](#)" on page 395

17.18.1.3 ARB settings

| | |
|--------------------------------------|-----|
| WGENerator<wg>:ARBGen:NAME..... | 775 |
| WGENerator<wg>:ARBGen:OPEN..... | 775 |
| WGENerator<wg>:ARBGen:RUNMode..... | 776 |
| WGENerator<wg>:ARBGen:RUNSingle..... | 776 |
| WGENerator<wg>:ARBGen:SAMPLEs?..... | 776 |
| WGENerator<wg>:ARBGen:SRATE..... | 777 |
| WGENerator<wg>:ARBGen[:SOURce]..... | 777 |

WGENerator<wg>:ARBGen:NAME <FilePath>

Sets the file path and the file for an arbitrary waveform, if [WGENerator<wg>:ARBGen\[:SOURce\]](#) is set to `ARBITrary`.

Suffix:

<wg> 1..2

Parameters:

<FilePath>

Usage: Asynchronous command

Manual operation: See "[Open](#)" on page 401

WGENerator<wg>:ARBGen:OPEN

Loads the arbitrary waveform, which is selected with the [WGENerator<wg>:ARBGen:NAME](#) command.

Suffix:
 <wg> 1..2

Usage: Setting only
 Asynchronous command

Manual operation: See ["Open"](#) on page 401

WGENerator<wg>:ARBGen:RUNMode <RunMode>

Sets the duration for which the signal of the arbitrary generator will be output after the trigger event.

Suffix:
 <wg> 1..2

Parameters:
 <RunMode> SINGLE | REPetitive
 *RST: REPetitive

Usage: Asynchronous command

Manual operation: See ["Run mode"](#) on page 400

WGENerator<wg>:ARBGen:RUNSingle

Executes a single period of the arbitrary signal generator, if [WGENerator<wg>:ARBGen:RUNMode](#) is set to `SINGLE`.

Suffix:
 <wg> 1..2

Usage: Event
 Asynchronous command

Manual operation: See ["Run single"](#) on page 400

WGENerator<wg>:ARBGen:SAMPLES?

Sets the sample rate for the arbitrary waveform.

Suffix:
 <wg> 1..2

Return values:
 <NumSamples> Range: 0 to 128000000
 Increment: 10
 *RST: 0
 Default unit: pts

Usage: Query only
 Asynchronous command

Manual operation: See ["Number of samples"](#) on page 401

WGENerator<wg>:ARBGen:SRATe <SampleRate>

Sets the sample rate for the arbitrary waveform.

Suffix:

<wg> 1..2

Parameters:

<SampleRate> Range: 1 to 312500000
Increment: 10
*RST: 1000000
Default unit: Sa/s

Usage: Asynchronous command

Manual operation: See "[Sample rate](#)" on page 401

WGENerator<wg>:ARBGen[:SOURce] <WaveformSource>

Selects the source of the arbitrary waveform.

Suffix:

<wg> 1..2

Parameters:

<WaveformSource> ARBbitrary | SCOPe
*RST: ARBbitrary

Usage: Asynchronous command

Manual operation: See "[Arb wfm source](#)" on page 401

17.18.1.4 Sweep settings

| | |
|--|-----|
| WGENerator<wg>:SWEep[:STATe] | 777 |
| WGENerator<wg>:SWEep:TYPE | 778 |
| WGENerator<wg>:SWEep:FSTart | 778 |
| WGENerator<wg>:SWEep:TIME | 778 |
| WGENerator<wg>:SWEep:FEND | 778 |

WGENerator<wg>:SWEep[:STATe] <Sweep>

Enables or disables the sweeping.

Suffix:

<wg> 1..2

Parameters:

<Sweep> ON | OFF
*RST: OFF

Usage: Asynchronous command

Manual operation: See "[Sweep state](#)" on page 397

WGENerator<wg>:SWEep:TYPE <Type>

Sets the type of the sweep, a linear or logarithmic change of the frequency.

Suffix:

<wg> 1..2

Parameters:

<Type> LIN | LOG
*RST: LIN

Usage: Asynchronous command

Manual operation: See "[Sweep type](#)" on page 397

WGENerator<wg>:SWEep:FSTart <StartFrequency>

Sets the start frequency of the sweep signal.

Suffix:

<wg> 1..2

Parameters:

<StartFrequency> Range: 0.001 to 100000000
Increment: 1
*RST: 1000
Default unit: Hz

Usage: Asynchronous command

Manual operation: See "[Start frequency](#)" on page 398

WGENerator<wg>:SWEep:TIME <Time>

Sets the duration of the sweep.

Suffix:

<wg> 1..2

Parameters:

<Time> Range: 0.001 to 500
Increment: 1
*RST: 0.001
Default unit: s

Usage: Asynchronous command

Manual operation: See "[Sweep time](#)" on page 398

WGENerator<wg>:SWEep:FEND <StopFrequency>

Sets the stop frequency of the sweep signal.

Suffix:

<wg> 1..2

Parameters:

<StopFrequency> Range: 0.001 to 100000000
 Increment: 1
 *RST: 1000000
 Default unit: Hz

Usage: Asynchronous command

Manual operation: See ["Stop frequency"](#) on page 398

17.18.2 Synchronize settings

| | |
|---|-----|
| WGENerator<wg>:COUPLing:STATe | 779 |
| WGENerator<wg>:COUPLing:AMPLitude | 779 |
| WGENerator<wg>:COUPLing:PHASeshift | 780 |
| WGENerator<wg>:COUPLing[:FREQUENCY] | 780 |
| GENerator:SYNC[:COMBination] | 780 |

WGENerator<wg>:COUPLing:STATe <CoupleEnable>

Enables the coupling of the generators, with the selected set of parameters: amplitude and frequency.

Suffix:

<wg> 1..2
 Specifies the prime generator.

Parameters:

<CoupleEnable> ON | OFF
 *RST: OFF

Usage: Asynchronous command

Manual operation: See ["Generator enable"](#) on page 402

WGENerator<wg>:COUPLing:AMPLitude <CplAmplitude>

Enables the coupling of all amplitude parameters of the generators.

Suffix:

<wg> 1..2
 Specifies the prime generator.

Parameters:

<CplAmplitude> ON | OFF
 *RST: OFF

Usage: Asynchronous command

Manual operation: See ["Frequency parameters"](#) on page 402

WGENerator<wg>:COUPling:PHASeshift <PhaseShift>

Sets the phase shift between the waveform of Gen1 and Gen2 when the frequency parameters of the two waveforms are coupled.

Suffix:

<wg> 1..2
Specifies the prime generator.

Parameters:

<PhaseShift> Range: -180 to 180
Increment: 1
*RST: 0
Default unit: °

Usage: Asynchronous command

Manual operation: See "[Phase Gen1 - Gen2](#)" on page 403

WGENerator<wg>:COUPling[:FREQuency] <CplFreq>

Enables the coupling of all frequency parameters of the generators.

Suffix:

<wg> 1..2
Specifies the prime generator.

Parameters:

<CplFreq> ON | OFF
*RST: OFF

Usage: Asynchronous command

Manual operation: See "[Amplitude parameters](#)" on page 403

GENerator:SYNC[:COMBination] <Combination>

Selects which signals generated from the waveform generator are synchronized.

Parameters:

<Combination> NONE | GEN12
*RST: NONE

Usage: Asynchronous command

Manual operation: See "[Synchron start](#)" on page 402

17.19 Status reporting

This chapter describes the remote commands that are used to read the status registers.

For information on structure, hierarchy, and contents of the status registers, see [Chapter 16.5, "Remote control - status reporting system"](#), on page 418.

| | |
|--|-----|
| • General commands | 781 |
| • STATus:OPERation register | 781 |
| • STATus:QUEStionable registers | 782 |
| • Reading out the CONDition part | 784 |
| • Reading out the EVENt part | 785 |
| • Controlling the ENABle part | 785 |
| • Controlling the negative transition part | 786 |
| • Controlling the positive transition part | 787 |
| • Programming tips and examples | 788 |

17.19.1 General commands

STATus:PRESet

Resets the status registers.

All PTRansition bits are set to 1, i.e. all transitions from 0 to 1 are detected.

All NTRansition bits are set to 0, i.e. a transition from 1 to 0 in a CONDition bit is not detected.

All EVENt bits are set to 0.

The ENABle bits of STATus:OPERation and STATus:QUEStionable are set to 0, i.e. all events in these registers are not passed on.

Usage: Setting only
 SCPI confirmed

17.19.2 STATus:OPERation register

STATus:OPERation commands provide information on the activity of the instrument.

See also: [Chapter 16.5.3.3, "STATus:OPERation register"](#), on page 423.

| | |
|---|-----|
| STATus:OPERation:CONDition? | 781 |
| STATus:OPERation[:EVENt]? | 781 |
| STATus:OPERation:ENABle | 782 |

STATus:OPERation:CONDition?

STATus:OPERation[:EVENt]?

The CONDition command returns information on actions the instrument is currently executing. The contents of the register is retained.

The EVENt command returns information on actions the instrument has executed since the last reading. Reading the EVENt register deletes its contents.

Bits:

- 0 = ALIGNment
- 2 = AUToset
- 4 = MEASuring
- 5 = WTRIGGER (wait for trigger)
- 6 = TRIGGERed

Example: For an example, see [Example "Querying with STATUS:OPERation:CONDition"](#) on page 789.

Usage: Query only

STATUS:OPERation:ENABLE <Enable>

Controls the ENABLE part of the STATUS:OPERation register. The ENABLE defines which events in the EVENT part of the status register are forwarded to the OPERATION summary bit (bit 7) of the status byte. The status byte can be used to create a service request.

Parameters:

<Enable> Range: 1 to 65535
 Increment: 1

Example: STATUS:OPERation:ENABLE 5
 The ALIGNment event (bit 0) and AUToset event (bit 2) are forwarded to the OPERATION summary bit of the status byte.

17.19.3 STATUS:QUESTIONable registers

The commands of the STATUS:QUESTIONable subsystem control the status reporting structures of the STATUS:QUESTIONable registers.

See also: [Chapter 16.5.3.4, "STATUS:QUESTIONable register"](#), on page 424.

The query of the [:EVENT] and [:ENABLE] commands, return a list of the affected sources:

Table 17-8: Source values for STATUS:QUESTIONable:....[:EVENT] and STATUS:QUESTIONable:....[:ENABLE]

| Bits | Source values | Description |
|--------------|---------------|-------------------------------------|
| For all bits | NONE | |
| | ALL | All available sources are activated |
| PPSupply | PRObe<m> | Active probe |
| POVerload | PRObe<m> | Active probe |
| COVerload | CHAN<m> | Analog channels |
| | WARNCHAN<m> | Warning overload channels |

| Bits | Source values | Description |
|-------------|---------------|---|
| | EXTTRIGGERIN | External analog signal connected to the external trigger input |
| | TRIGGEROUT | Trigger out signal |
| TEMPerature | TEMPWARN | Temperature warning: indicates that the device is getting hot and should be cooled. |
| | TEMPERROR | Temperature error: the device is too hot and will automatically shut down in a few seconds. |
| ADCState | CPCHAN<m> | Positive clipping for analog channels |
| | CNCHAN<m> | Negative clipping for analog channels |
| | CPPRobe<m> | Positive clipping for probes |
| | CNPRobe<m> | Negative clipping for probes |
| GOVerload | WGENerator<m> | Available generators |
| NOALigndata | HCHannel<m> | Horizontal channels |
| | VCHannel<m> | Vertical channels |
| | PROBe<m> | Probes channels |
| | LPRObes<m> | Logic probes |
| | WGENerator<m> | Available generators |
| LIMit | MEAS<m> | Enabled measurements |
| MARGin | MEAS<m> | Enabled measurements |
| IMPRecise | MEAS<m> | Enabled measurements |

Some of the status commands can be used interchangeably:

Table 17-9: Overview: STATus:QUESTionable and respective CHANnel, MEASurement and WGENerator commands

| STATus:QUESTionable register | MEASurement |
|--|---------------------------------------|
| STATus:QUESTionable:COVerload
Bit: CHANnel<ch> | CHANnel<ch>:OVERload:STATus |
| STATus:QUESTionable:COVerload
Bit: WCHannel<ch> | CHANnel<ch>:WARNoverload:STATus |
| STATus:QUESTionable:COVerload
Bit: EXTTRIGGERIN | TRIGger:ANEDge:OVERload:STATus |
| STATus:QUESTionable:COVerload
Bit: TRIGGEROUT | TRIGger:ACTions:OUT:OVERload:STATus |
| STATus:QUESTionable:ADCState
Bit: CPCHannel<ch> | CHANnel<ch>:ADCState:STATus:PClipping |
| STATus:QUESTionable:ADCState
Bit: CNCHannel<ch> | CHANnel<ch>:ADCState:STATus:NClipping |

| | |
|--|----------------------------------|
| STATus:QUEStionable register | MEASurement |
| STATus:QUEStionable:PPSupply
Bit: CNCHannel<ch> | CHANnel<ch>PPSupply:STATus |
| STATus:QUEStionable:LIMit
Bit: MEASurement<mg> | MEASurement<mg>:LIMit:STATus |
| STATus:QUEStionable:MARGin
Bit: MEASurement<mg> | MEASurement<mg>:MARGin:STATus |
| STATus:QUEStionable:IMPRecise
Bit: MEASurement<mg> | MEASurement<mg>:IMPRecise:STATus |
| STATus:QUEStionable:GOVerload
Bit: WGENerator<wg> | WGENerator<wg>:GOVerload |
| STATus:QUEStionable:
TEMPerature
Bit: WGENerator<wg> | WGENerator<wg>:TEMPerature |

17.19.4 Reading out the CONDition part

CHANnel<ch>:OVERload:STATus:CONDition?
CHANnel<ch>:ADCState:STATus:NCLipping:CONDition?
CHANnel<ch>:ADCState:STATus:PCLipping:CONDition?
CHANnel<ch>:WARNoverload:STATus:CONDition?
CHANnel<ch>:PPSupply:STATus:CONDition?
MEASurement<mg>:IMPRecise:STATus:CONDition?
MEASurement<mg>:LIMit:STATus:CONDition?
MEASurement<mg>:MARGin:STATus:CONDition?
TRIGger:ACTions:OUT:OVERload:STATus:CONDition?
TRIGger:ANEDge:OVERload:STATus:CONDition?
WGENerator<wg>:GOVerload:STATus:CONDition?
WGENerator<wg>:TEMPerature:STATus:CONDition?
STATus:QUEStionable:ADCState:CONDition?
STATus:QUEStionable:COVERload:CONDition?
STATus:QUEStionable:GOVerload:CONDition?
STATus:QUEStionable:IMPRecise:CONDition?
STATus:QUEStionable:LIMit:CONDition?
STATus:QUEStionable:MARGin:CONDition?
STATus:QUEStionable:PLL:CONDition?
STATus:QUEStionable:PPSupply:CONDition?
STATus:QUEStionable:TEMPerature:CONDition?

Returns the contents of the CONDition part of the status register to check for questionable instrument or measurement states. This part contains information on the action currently being performed in the instrument.

Reading the CONDition registers does not delete the contents since it indicates the current hardware status.

Usage: Query only

17.19.5 Reading out the EVENT part

```

CHANnel<ch>:ADCState:STATus:NCLipping[:EVENT]?
CHANnel<ch>:ADCState:STATus:PCLipping[:EVENT]?
CHANnel<ch>:OVERload:STATus[:EVENT] <Value>
CHANnel<ch>:WARNoverload:STATus[:EVENT]?
CHANnel<ch>:PPSupply:STATus[:EVENT] <Value>
MEASurement<mg>:IMPRecise:STATus[:EVENT]?
MEASurement<mg>:LIMit:STATus[:EVENT]?
MEASurement<mg>:MARGin:STATus[:EVENT]?
TRIGger:ACTions:OUT:OVERload:STATus[:EVENT] <Value>
TRIGger:ANEDge:OVERload:STATus[:EVENT] <Value>
WGENerator<wg>:GOVerload:STATus[:EVENT] <Value>
WGENerator<wg>:TEMPerature:STATus[:EVENT] <Value>
STATus:QUEStionable:ADCState[:EVENT]?
STATus:QUEStionable:COVerload[:EVENT]?
STATus:QUEStionable:GOVerload[:EVENT]?
STATus:QUEStionable:IMPRecise[:EVENT]?
STATus:QUEStionable:LIMit[:EVENT]?
STATus:QUEStionable:MARGin[:EVENT]?
STATus:QUEStionable:PLL[:EVENT]?
STATus:QUEStionable:PPSupply[:EVENT]?
STATus:QUEStionable:TEMPerature[:EVENT]?

```

Returns the contents of the `EVENT` part of the status register to check if an event has occurred since the last reading.

Reading an `EVENT` register deletes its contents.

Parameters:

<Value> See [Source values for STATus:QUEStionable:...\[:EVENT\] and STATus:QUEStionable:...\[:ENABLE\]](#) for a list of the return values.

Usage: Query only

17.19.6 Controlling the ENABLE part

```

CHANnel<ch>:OVERload:STATus:ENABLE <Value>
CHANnel<ch>:ADCState:STATus:NCLipping:ENABLE <Value>
CHANnel<ch>:ADCState:STATus:PCLipping:ENABLE <Value>
CHANnel<ch>:WARNoverload:STATus:ENABLE <Value>
CHANnel<ch>:PPSupply:STATus:ENABLE <Value>
MEASurement<mg>:IMPRecise:STATus:ENABLE <Value>
MEASurement<mg>:LIMit:STATus:ENABLE <Value>
MEASurement<mg>:MARGin:STATus:ENABLE <Value>
TRIGger:ACTions:OUT:OVERload:STATus:ENABLE <Value>

```

TRIGger:ANEDge:OVERload:STATus:ENABle <Value>
WGENerator<wg>:GOVERload:STATus:ENABle <Value>
WGENerator<wg>:TEMPerature:STATus:ENABle <Value>
STATus:QUESTionable:ADCState:ENABle <Value>
STATus:QUESTionable:COVERload:ENABle <Value>
STATus:QUESTionable:GOVERload:ENABle <Value>
STATus:QUESTionable:IMPRecise:ENABle <Value>
STATus:QUESTionable:LIMit:ENABle <Value>
STATus:QUESTionable:MARGIN:ENABle <Value>
STATus:QUESTionable:PLL:ENABle <Value>
STATus:QUESTionable:PPSupply:ENABle <Value>
STATus:QUESTionable:TEMPerature:ENABle <Value>

Sets the **ENABle** part that allows true conditions in the **EVENT** part to be reported for the summary bit in the status byte.

These events can be used for a service request. If a bit in the **ENABle** part is 1, and the corresponding **EVENT** bit is true, a positive transition occurs in the summary bit. This transition is reported to the next higher level.

See [Source values for STATus:QUESTionable:....\[:EVENT\]](#) and [STATus:QUESTionable:....\[:ENABle\]](#) for a list of the return values.

Parameters:

<Value> bit dependent

17.19.7 Controlling the negative transition part

CHANnel<ch>:ADCState:STATus:NCLipping:NTRansition <Value>
CHANnel<ch>:ADCState:STATus:PCLipping:NTRansition <Value>
CHANnel<ch>:OVERload:STATus:NTRansition <Value>
CHANnel<ch>:PPSupply:STATus:NTRansition <Value>
CHANnel<ch>:WARNoverload:STATus:NTRansition <Value>
MEASurement<mg>:IMPRecise:STATus:NTRansition <Value>
MEASurement<mg>:LIMit:STATus:NTRansition <Value>
MEASurement<mg>:MARGIN:STATus:NTRansition <Value>
TRIGger:ACTions:OUT:OVERload:STATus:NTRansition <Value>
TRIGger:ACTions:OUT:OVERload:STATus:PTRansition <Value>
WGENerator<wg>:GOVERload:STATus:NTRansition <Value>
WGENerator<wg>:TEMPerature:STATus:NTRansition <Value>
STATus:QUESTionable:ADCState:NTRansition <Value>
STATus:QUESTionable:COVERload:NTRansition <Value>
STATus:QUESTionable:GOVERload:NTRansition <Value>
STATus:QUESTionable:IMPRecise:NTRansition <Value>
STATus:QUESTionable:LIMit:NTRansition <Value>
STATus:QUESTionable:MARGIN:NTRansition <Value>
STATus:QUESTionable:PLL:NTRansition <Value>
STATus:QUESTionable:PPSupply:NTRansition <Value>
STATus:QUESTionable:TEMPerature:NTRansition <Value>

Sets the negative transition filter.

If a bit is set, a transition from 1 to 0 in the condition part causes an entry to be made in the corresponding bit of the `EVENT` part of the register.

Parameters:

<Value> Source dependent

17.19.8 Controlling the positive transition part

CHANnel<ch>:ADCState:STATus:NCLipping:PTRansition <Value>
CHANnel<ch>:ADCState:STATus:PCLipping:PTRansition <Value>
CHANnel<ch>:OVERload:STATus:PTRansition <Value>
CHANnel<ch>:PPSupply:STATus:PTRansition <Value>
CHANnel<ch>:WARNoverload:STATus:PTRansition <Value>
MEASurement<mg>:IMPRecise:STATus:PTRansition <Value>
MEASurement<mg>:LIMit:STATus:PTRansition <Value>
MEASurement<mg>:MARGin:STATus:PTRansition <Value>
TRIGger:ACTions:OUT:OVERload:STATus:PTRansition <Value>
TRIGger:ANEDge:OVERload:STATus:PTRansition <Value>
WGENerator<wg>:GOVerload:STATus:PTRansition <Value>
WGENerator<wg>:TEMPerature:STATus:PTRansition <Value>
STATus:QUESTionable:ADCState:PTRansition <Value>
STATus:QUESTionable:COVerload:PTRansition <Value>
STATus:QUESTionable:GOVerload:PTRansition <Value>
STATus:QUESTionable:IMPRecise:PTRansition <Value>
STATus:QUESTionable:LIMit:PTRansition <Value>
STATus:QUESTionable:MARGin:PTRansition <Value>
STATus:QUESTionable:PLL:PTRansition <Value>
STATus:QUESTionable:PPSupply:PTRansition <Value>
STATus:QUESTionable:TEMPerature:PTRansition <Value>

Sets the positive transition filter.

If a bit is set, a transition from 0 to 1 in the condition part causes an entry to be made in the corresponding bit of the `EVENT` part of the register.

Parameters:

<Value> Source dependent

17.19.9 Programming tips and examples

Example: Observing the limits violation of a measurement

The following example describes how to use the status register commands to observe, if a violation of a measurement limit has occurred.

```
*SRE 8
// Enables the STATus:QUEStionable bit in the service-request (SRE)

STATus:QUEStionable:ENABle 512
// Enables the LIMit bit of the STATus:QUEStionable register

MEASurement1:ENABle ON
MEASurement2:ENABle ON
MEASurement3:ENABle ON
// Enables measurement 1,2,3

STATus:QUEStionable:LIMit:ENABle ALL
// Enables the limit check for all active measurements

STATus:QUEStionable:LIMit:ENABle?
MEAS1,MEAS2,MEAS3
//Queries which measurement were active at the time the
//STATus:QUEStionable:LIMit:ENABle was send

*SRQ?
// A service request was sent

*STB?
72
// STATus:QUEStionable is set:
// #72= 64 + 8 = 2^6 + 2^3
// 64 : bit 6 is awlays on when a SRQ is sent
// 8: bit 3 for STATus:QUEStionable

STATus:QUEStionable:EVENT?
512
// 512= 2^9,

STATus:QUEStionable:LIMit:EVENT?
MEAS1,MEAS2
// Measurements 1 and 2 have exceeded the limit
// The event register is cleared after the query

STATus:QUEStionable:LIMit:EVENT?
NONE
// The event bit has been set to 0 after the first query
```

```

STATus:QUEStionable:LIMit:CONDition?
MEAS1,MEAS2
// Measurements 1 and 2 are still exceeding the limit

STATus:QUEStionable:EVENT?
0

// Waiting for an event
*SRQ?

// Measurement 3 exceeds the limit

STATus:QUEStionable:LIMit:CONDition?
MEAS1,MEAS2,MEAS3
// Measurements 1,2 and 3 are currently exceeding the limit

STATus:QUEStionable:LIMit:EVENT?
MEAS3
// Measurement 3 has newly exceeded the limit
// The event register is cleared after the query

```

Example: Querying with STATus:OPERation:CONDition

The following example shows how the result of STATus:OPERation:CONDition? changes during a single acquisition.

```

SINGLE
// Measurement starts

STATus:OPERation:CONDition?
16
//Measuring

STATus:OPERation:CONDition?
48
//Pre trigger waiting time is over (16 Measuring + 32 WaitForTrigger)

STATus:OPERation:CONDition?
112
//Trigger is deactivated (16 Measuring + 32 WaitForTrigger + 64 Triggered)

STATus:OPERation:CONDition?
96
// Measurement has finished (32 WaitForTrigger + 64 Triggered)

```

Query OPC status in the event status register

If you activate a time-consuming operation and wait for completion with *OPC?, a time-out could occur before the operation is finished and you do not receive the returned

“1”. In addition, the test program is blocked while waiting with *OPC?. It is not possible to process other (not interdependent) commands in the meantime or to communicate with other instruments.

Thus, for time-consuming operations, you can avoid blocking the communication by sending the operation complete command *OPC:

```
*CLS
```

```
*OPC
```

Afterwards you can poll the operation complete status in the event status register with *ESR?.

This query returns the content of the event status register and afterwards clears the content. See also [Chapter 16.5.3.2, "Event status register \(ESR\) and event status enable register \(ESE\)"](#), on page 422.

18 Maintenance and support

The instrument does not need periodic maintenance. Only the cleaning of the instrument is essential.

To protect the front panel and to transport the instrument to another workplace safely and easily, various accessories are provided. Refer to the data sheet for available covers and cases and their order numbers.

18.1 Cleaning

How to clean the product is described in "[Cleaning the product](#)" on page 20.

Do not use any liquids for cleaning. Cleaning agents, solvents, acids and bases can damage the front panel labeling, plastic parts and display.

18.2 Changing fuses

If the product does not start, it is possible that a blown fuse is the cause.

The product is protected by 2 fuses of type Size 5x20 mm, 250V~, T5H (slow-blow), IEC 60127-2 (order no. 0099.6735.00), order number 0099.6735.00.

1. **WARNING!** The fuse is part of the main power supply. Handling the fuse while the power is on can lead to electric shock.
Before changing the fuse:
 - a) Set the switch on the power supply to position [0].
 - b) Disconnect the product from the power source.
2. The fuse slot is on the rear panel between the main power switch and AC power supply connector.
Pull out the fuse holder.
3. Check the condition of the fuse.
4. Replace the blown fuse. Only use a fuse of the specified type.
5. Insert the fuse holder into its slot until it latches.

18.3 Contacting customer support

Technical support – where and when you need it

For quick, expert help with any Rohde & Schwarz product, contact our customer support center. A team of highly qualified engineers provides support and works with you

to find a solution to your query on any aspect of the operation, programming or applications of Rohde & Schwarz products.

Contact information

Contact our customer support center at www.rohde-schwarz.com/support, or follow this QR code:



Figure 18-1: QR code to the Rohde & Schwarz support page

18.4 Information for technical support

If you encounter problems that you cannot solve yourself, contact your Rohde & Schwarz support center, see [Contacting customer support](#).

The support center finds solutions more quickly and efficiently, if you provide them with information on the instrument and an error description. To create, collect and save the required information, you can create a service report.

The service report is a ZIP file with a complete bug report, all relevant setup information, reporting and log files, alignment files, and the instrument configuration.

1. Open the "Settings" > "Maintenance" dialog.
2. Select the "Service" tab.
3. Tap "Create report".
If a USB flash drive is connected, the report is saved on the USB flash drive. Otherwise, the report is saved in the user data folder `/home/storage/userData`.
4. Create a support ticket that describes the problem, and attach the report file.

See also: [Chapter 5.7.4, "Service"](#), on page 94.

18.5 Data security

If you have to send the instrument to the service, or if the instrument is used in a secured environment, consider the document "Instrument Security Procedures" that is delivered on the R&S MXO 5 webpage.

18.6 Transporting

Lifting and carrying

See: "[Lifting and carrying the instrument](#)" on page 16

Packing

Use the original packaging material. It consists of antistatic wrap for electrostatic protection and packing material designed for the product.

If you do not have the original packaging, use similar materials that provide the same level of protection. You can also contact your local Rohde & Schwarz service center for advice.

Securing

When moving the R&S MXO 5 in a vehicle or using transporting equipment, make sure that the R&S MXO 5 is properly secured. Only use items intended for securing objects.

Transport altitude

Unless otherwise specified in the data sheet, the maximum transport altitude without pressure compensation is 4500 m above sea level.

18.7 Storage

Protect the product against dust. Ensure that the environmental conditions, e.g. temperature range and climatic load, meet the values specified in the data sheet.

18.8 Disposal

Rohde & Schwarz is committed to making careful, ecologically sound use of natural resources and minimizing the environmental footprint of our products. Help us by disposing of waste in a way that causes minimum environmental impact.

Disposing of electrical and electronic equipment

A product that is labeled as follows cannot be disposed of in normal household waste after it has come to the end of its life. Even disposal via the municipal collection points for waste electrical and electronic equipment is not permitted.



Figure 18-2: Labeling in line with EU directive WEEE

Rohde & Schwarz has developed a disposal concept for the eco-friendly disposal or recycling of waste material. As a manufacturer, Rohde & Schwarz completely fulfills its obligation to take back and dispose of electrical and electronic waste. Contact your local service representative to dispose of the product.

List of commands

| | |
|----------------------------------|-----|
| *CAL? | 436 |
| *CLS | 436 |
| *IDN? | 436 |
| *OPC | 437 |
| *OPT? | 437 |
| *RCL | 437 |
| *RST | 437 |
| *SAV | 438 |
| *SRE | 438 |
| *STB? | 438 |
| *TRG | 438 |
| *WAI | 438 |
| ACQUIRE:AVAILABLE? | 471 |
| ACQUIRE:AVERAGE? | 471 |
| ACQUIRE:COUNT | 472 |
| ACQUIRE:CURRENT? | 472 |
| ACQUIRE:HISTORY:CURRENT | 531 |
| ACQUIRE:HISTORY:PLAY | 531 |
| ACQUIRE:HISTORY:REPLAY | 531 |
| ACQUIRE:HISTORY:START | 532 |
| ACQUIRE:HISTORY:STOP | 532 |
| ACQUIRE:HISTORY:TPACQ | 532 |
| ACQUIRE:HISTORY:TSABSOLUTE? | 532 |
| ACQUIRE:HISTORY:TSDATE? | 533 |
| ACQUIRE:HISTORY:TSRELATIVE? | 533 |
| ACQUIRE:HISTORY:TSREFERENCE? | 533 |
| ACQUIRE:HISTORY[:STATE] | 534 |
| ACQUIRE:INTERPOLATE | 472 |
| ACQUIRE:POINTS:ARATE? | 473 |
| ACQUIRE:POINTS:MAXIMUM | 473 |
| ACQUIRE:POINTS:MODE | 473 |
| ACQUIRE:POINTS[:VALUE] | 473 |
| ACQUIRE:RESOLUTION | 474 |
| ACQUIRE:ROLLMODE:OSCATURE | 463 |
| ACQUIRE:ROLLMODE:POINTS? | 464 |
| ACQUIRE:SEGMENTED:MAX | 476 |
| ACQUIRE:SEGMENTED:STATE | 476 |
| ACQUIRE:SRATE:MINIMUM | 475 |
| ACQUIRE:SRATE:MODE | 475 |
| ACQUIRE:SRATE[:VALUE] | 474 |
| ACQUIRE:SRREAL | 475 |
| ACQUIRE:TYPE | 475 |
| AUTOSCALE | 461 |
| CALCULATE:MATH<m>:DATA:HEADER? | 529 |
| CALCULATE:MATH<m>:DATA:STYPE? | 530 |
| CALCULATE:MATH<m>:DATA[:VALUES]? | 530 |
| CALCULATE:MATH<m>:ENVSELECTION | 529 |

| | |
|--|-----|
| CALCulate:MATH<m>:STATe..... | 526 |
| CALCulate:MATH<m>:VERTical:OFFSet..... | 528 |
| CALCulate:MATH<m>:VERTical:SCALe:MODE..... | 529 |
| CALCulate:MATH<m>:VERTical:SCALe[:VALue]..... | 528 |
| CALCulate:MATH<m>[:EXPRession][:DEFine]..... | 527 |
| CALCulate:SPEctrum<sp>:FREQuency:BANDwidth[:RESolution]:AUTO..... | 589 |
| CALCulate:SPEctrum<sp>:FREQuency:BANDwidth[:RESolution]:RATio..... | 589 |
| CALCulate:SPEctrum<sp>:FREQuency:BANDwidth[:RESolution][:VALue]..... | 589 |
| CALCulate:SPEctrum<sp>:FREQuency:CENTer..... | 590 |
| CALCulate:SPEctrum<sp>:FREQuency:SCALe..... | 590 |
| CALCulate:SPEctrum<sp>:FREQuency:SPAN..... | 590 |
| CALCulate:SPEctrum<sp>:FREQuency:STARt..... | 591 |
| CALCulate:SPEctrum<sp>:FREQuency:STOP..... | 591 |
| CALCulate:SPEctrum<sp>:FREQuency:WINDow:TYPE..... | 591 |
| CALCulate:SPEctrum<sp>:GATE:POSition..... | 596 |
| CALCulate:SPEctrum<sp>:GATE:STARt..... | 596 |
| CALCulate:SPEctrum<sp>:GATE:STOP..... | 597 |
| CALCulate:SPEctrum<sp>:GATE:WIDTh..... | 597 |
| CALCulate:SPEctrum<sp>:MAGNitude:LEVel..... | 592 |
| CALCulate:SPEctrum<sp>:MAGNitude:RANGe..... | 592 |
| CALCulate:SPEctrum<sp>:MAGNitude:SCALe..... | 593 |
| CALCulate:SPEctrum<sp>:PEXCursion..... | 594 |
| CALCulate:SPEctrum<sp>:PLISt:COUNT?..... | 597 |
| CALCulate:SPEctrum<sp>:PLISt:LAbel:BORDer..... | 453 |
| CALCulate:SPEctrum<sp>:PLISt:LAbel:FREQuency[:STATe]..... | 600 |
| CALCulate:SPEctrum<sp>:PLISt:LAbel:INVert..... | 601 |
| CALCulate:SPEctrum<sp>:PLISt:LAbel:MAXCount..... | 600 |
| CALCulate:SPEctrum<sp>:PLISt:LAbel:MAXCount..... | 601 |
| CALCulate:SPEctrum<sp>:PLISt:LAbel[:STATe]..... | 601 |
| CALCulate:SPEctrum<sp>:PLISt:MAXCount..... | 598 |
| CALCulate:SPEctrum<sp>:PLISt:MODE..... | 598 |
| CALCulate:SPEctrum<sp>:PLISt:RESUlt[:VALue]?..... | 599 |
| CALCulate:SPEctrum<sp>:PLISt:SORT:COLumn..... | 599 |
| CALCulate:SPEctrum<sp>:PLISt:SORT:ORDer..... | 600 |
| CALCulate:SPEctrum<sp>:PLISt:SOURce..... | 599 |
| CALCulate:SPEctrum<sp>:PLISt:SPOW..... | 599 |
| CALCulate:SPEctrum<sp>:PLISt[:STATe]..... | 598 |
| CALCulate:SPEctrum<sp>:PRESet..... | 593 |
| CALCulate:SPEctrum<sp>:SOURce..... | 593 |
| CALCulate:SPEctrum<sp>:STATe..... | 594 |
| CALCulate:SPEctrum<sp>:THReshold..... | 594 |
| CALCulate:SPEctrum<sp>:WAVEform:AVERAge:COUNT..... | 595 |
| CALCulate:SPEctrum<sp>:WAVEform:AVERAge:DATA:HEADer?..... | 601 |
| CALCulate:SPEctrum<sp>:WAVEform:AVERAge:DATA[:VALues]?..... | 602 |
| CALCulate:SPEctrum<sp>:WAVEform:AVERAge:ENABLE..... | 595 |
| CALCulate:SPEctrum<sp>:WAVEform:MAXimum:DATA:HEADer?..... | 601 |
| CALCulate:SPEctrum<sp>:WAVEform:MAXimum:DATA[:VALues]?..... | 602 |
| CALCulate:SPEctrum<sp>:WAVEform:MAXimum:ENABLE..... | 595 |
| CALCulate:SPEctrum<sp>:WAVEform:MINimum:DATA:HEADer?..... | 601 |
| CALCulate:SPEctrum<sp>:WAVEform:MINimum:DATA[:VALues]?..... | 602 |

| | |
|--|-----|
| CALCulate:SPECTrum<sp>:WAVEform:MINimum:ENABLE..... | 595 |
| CALCulate:SPECTrum<sp>:WAVEform:NORMAL:DATA:HEADER?..... | 601 |
| CALCulate:SPECTrum<sp>:WAVEform:NORMAL:DATA[:VALUES]?..... | 602 |
| CALCulate:SPECTrum<sp>:WAVEform:NORMAL[:ENABLE]..... | 596 |
| CALibration:DATE?..... | 459 |
| CALibration:RESult?..... | 459 |
| CALibration:TIME?..... | 459 |
| CHANnel<ch>:ADCState:STATus:NCLipping:CONDition?..... | 784 |
| CHANnel<ch>:ADCState:STATus:NCLipping:ENABLE..... | 785 |
| CHANnel<ch>:ADCState:STATus:NCLipping:NTRansition..... | 786 |
| CHANnel<ch>:ADCState:STATus:NCLipping:PTRansition..... | 787 |
| CHANnel<ch>:ADCState:STATus:NCLipping[:EVENT]?..... | 785 |
| CHANnel<ch>:ADCState:STATus:PCLipping:CONDition?..... | 784 |
| CHANnel<ch>:ADCState:STATus:PCLipping:ENABLE..... | 785 |
| CHANnel<ch>:ADCState:STATus:PCLipping:NTRansition..... | 786 |
| CHANnel<ch>:ADCState:STATus:PCLipping:PTRansition..... | 787 |
| CHANnel<ch>:ADCState:STATus:PCLipping[:EVENT]?..... | 785 |
| CHANnel<ch>:BANDwidth..... | 468 |
| CHANnel<ch>:COUPling..... | 466 |
| CHANnel<ch>:EATScale..... | 468 |
| CHANnel<ch>:EATTenuation..... | 468 |
| CHANnel<ch>:IMPedance..... | 469 |
| CHANnel<ch>:INVert..... | 467 |
| CHANnel<ch>:OFFSet..... | 465 |
| CHANnel<ch>:OVERload:STATus:CONDition?..... | 784 |
| CHANnel<ch>:OVERload:STATus:ENABLE..... | 785 |
| CHANnel<ch>:OVERload:STATus:NTRansition..... | 786 |
| CHANnel<ch>:OVERload:STATus:PTRansition..... | 787 |
| CHANnel<ch>:OVERload:STATus[:EVENT]..... | 785 |
| CHANnel<ch>:POSition..... | 466 |
| CHANnel<ch>:PPSupply:STATus:CONDition?..... | 784 |
| CHANnel<ch>:PPSupply:STATus:ENABLE..... | 785 |
| CHANnel<ch>:PPSupply:STATus:NTRansition..... | 786 |
| CHANnel<ch>:PPSupply:STATus:PTRansition..... | 787 |
| CHANnel<ch>:PPSupply:STATus[:EVENT]..... | 785 |
| CHANnel<ch>:RANGe..... | 465 |
| CHANnel<ch>:SCALE..... | 465 |
| CHANnel<ch>:SKEW:TIME..... | 467 |
| CHANnel<ch>:STATe..... | 464 |
| CHANnel<ch>:WARNOverload:STATus:CONDition?..... | 784 |
| CHANnel<ch>:WARNOverload:STATus:ENABLE..... | 785 |
| CHANnel<ch>:WARNOverload:STATus:NTRansition..... | 786 |
| CHANnel<ch>:WARNOverload:STATus:PTRansition..... | 787 |
| CHANnel<ch>:WARNOverload:STATus[:EVENT]?..... | 785 |
| CHANnel<ch>[:WAVEform<wf>]:DATA:HEADER?..... | 469 |
| CHANnel<ch>[:WAVEform<wf>]:DATA[:VALUES]?..... | 470 |
| CURSor<cu>:AOFF..... | 578 |
| CURSor<cu>:COUNT?..... | 578 |
| CURSor<cu>:FFT:SETCenter..... | 585 |
| CURSor<cu>:FFT:TOCenter..... | 586 |

| | |
|------------------------------------|-----|
| CURSor<cu>:FUNctIon..... | 579 |
| CURSor<cu>:LABel..... | 582 |
| CURSor<cu>:MAXimum:LEFT..... | 586 |
| CURSor<cu>:MAXimum:NEXT..... | 587 |
| CURSor<cu>:MAXimum:RIGHT..... | 586 |
| CURSor<cu>:MAXimum[:PEAK]..... | 586 |
| CURSor<cu>:PEXCursion..... | 587 |
| CURSor<cu>:SIAD..... | 582 |
| CURSor<cu>:SOURce..... | 579 |
| CURSor<cu>:SSOURce..... | 580 |
| CURSor<cu>:STATe..... | 579 |
| CURSor<cu>:STYLe..... | 587 |
| CURSor<cu>:THReshold..... | 587 |
| CURSor<cu>:TRACking[:STATe]..... | 582 |
| CURSor<cu>:USSource..... | 580 |
| CURSor<cu>:X1ENvelope..... | 583 |
| CURSor<cu>:X1Position..... | 580 |
| CURSor<cu>:X2ENvelope..... | 583 |
| CURSor<cu>:X2Position..... | 581 |
| CURSor<cu>:XCoupling..... | 582 |
| CURSor<cu>:XDELta:INVerse?..... | 584 |
| CURSor<cu>:XDELta[:VALue]?..... | 584 |
| CURSor<cu>:Y1Position..... | 581 |
| CURSor<cu>:Y2Position..... | 581 |
| CURSor<cu>:YCOupling..... | 583 |
| CURSor<cu>:YDELta:SLOPe..... | 585 |
| CURSor<cu>:YDELta[:VALue]?..... | 585 |
| DIGital<m>:DATA:HEADer?..... | 759 |
| DIGital<m>:DATA[:VALues]?..... | 759 |
| DIGital<m>:LABel..... | 749 |
| DIGital<m>:SIZE..... | 750 |
| DIGital<m>:SKEW..... | 750 |
| DIGital<m>:STATe..... | 750 |
| DIGital<m>:TECHnology..... | 751 |
| DIGital<m>:THCOupling..... | 751 |
| DIGital<m>:THReshold..... | 751 |
| DISPlay:BACKlight:DIMMING..... | 456 |
| DISPlay:BACKlight[:BRIGtness]..... | 455 |
| DISPlay:CLR..... | 456 |
| DISPlay:COLor:SIGNal:ASSign..... | 450 |
| DISPlay:COLor:SIGNal:CATalog?..... | 449 |
| DISPlay:COLor:SIGNal:COLor..... | 450 |
| DISPlay:COLor:SIGNal:USE..... | 450 |
| DISPlay:DIAGram:CROSShair..... | 451 |
| DISPlay:DIAGram:FINegrid..... | 451 |
| DISPlay:DIAGram:GRID..... | 451 |
| DISPlay:DIAGram:LABels..... | 451 |
| DISPlay:DIAGram:STYLe..... | 455 |
| DISPlay:DIAGram:YFIXed..... | 452 |
| DISPlay:DIALog:FONTSize..... | 452 |

| | |
|--|-----|
| DISPlay:DIALog:TRANsparency..... | 452 |
| DISPlay:INTensity..... | 455 |
| DISPlay:PERsistence:INFinite..... | 454 |
| DISPlay:PERsistence:RESet..... | 454 |
| DISPlay:PERsistence:TIME..... | 454 |
| DISPlay:PERsistence[:STATe]..... | 454 |
| DISPlay:RESult:FONTsize..... | 453 |
| DISPlay:TOOLbar:COUNt?..... | 449 |
| DISPlay:TOOLbar:DESelect..... | 449 |
| DISPlay:TOOLbar:REStore..... | 449 |
| EXPort:RESult:DELimiter..... | 458 |
| EXPort:RESult:NAME..... | 553 |
| EXPort:RESult:SAVE..... | 554 |
| EXPort:RESult:SElect:CURSor..... | 554 |
| EXPort:RESult:SElect:FRA:MARGin..... | 618 |
| EXPort:RESult:SElect:FRA:MARKer..... | 618 |
| EXPort:RESult:SElect:FRA:RESult..... | 618 |
| EXPort:RESult:SElect:MEASurement..... | 554 |
| EXPort:RESult:SElect:POWer<m>..... | 620 |
| EXPort:WAVEform:ABORt..... | 551 |
| EXPort:WAVEform:CURSorset..... | 553 |
| EXPort:WAVEform:GATE..... | 553 |
| EXPort:WAVEform:NAME..... | 551 |
| EXPort:WAVEform:SAVE..... | 551 |
| EXPort:WAVEform:SCOPE..... | 551 |
| EXPort:WAVEform:SOURce..... | 552 |
| EXPort:WAVEform:STARt..... | 552 |
| EXPort:WAVEform:STOP..... | 553 |
| FORMat:BPATtern..... | 440 |
| FORMat[:DATA]..... | 439 |
| FRANalysis:AMPLitude:ENABle..... | 613 |
| FRANalysis:AMPLitude:MODE..... | 604 |
| FRANalysis:AMPLitude:OFFSet..... | 613 |
| FRANalysis:AMPLitude:PROFile:APOint..... | 609 |
| FRANalysis:AMPLitude:PROFile:COUNt..... | 609 |
| FRANalysis:AMPLitude:PROFile:MODE..... | 610 |
| FRANalysis:AMPLitude:PROFile:POINt<m>:AMPLitude..... | 610 |
| FRANalysis:AMPLitude:PROFile:POINt<m>:FREQUency..... | 610 |
| FRANalysis:AMPLitude:PROFile:POINt<m>:REMOve..... | 609 |
| FRANalysis:AMPLitude:PROFile:SORT..... | 609 |
| FRANalysis:AMPLitude:SCALE..... | 613 |
| FRANalysis:AUTOscale..... | 604 |
| FRANalysis:CALibration:CALibration..... | 611 |
| FRANalysis:CALibration:RESult?..... | 611 |
| FRANalysis:CALibration:STATe..... | 611 |
| FRANalysis:ENABle..... | 604 |
| FRANalysis:FREQUency:DATA?..... | 614 |
| FRANalysis:FREQUency:STARt..... | 604 |
| FRANalysis:FREQUency:STOP..... | 605 |
| FRANalysis:GAIN:DATA?..... | 614 |

| | |
|---|-----|
| FRANalysis:GAIN:ENABle..... | 612 |
| FRANalysis:GAIN:OFFSet..... | 612 |
| FRANalysis:GAIN:SCALe..... | 613 |
| FRANalysis:GENerator:AMPLitude..... | 605 |
| FRANalysis:GENerator:LOAD..... | 605 |
| FRANalysis:GENerator[:CHANnel]..... | 605 |
| FRANalysis:INPut[:SOURce]..... | 606 |
| FRANalysis:MARGin:GAIN:FREQuency?..... | 616 |
| FRANalysis:MARGin:GAIN:VALue?..... | 616 |
| FRANalysis:MARGin:PHASe:FREQuency?..... | 616 |
| FRANalysis:MARGin:PHASe:VALue?..... | 616 |
| FRANalysis:MARGin:STATe..... | 615 |
| FRANalysis:MARKer<m>:FREQuency..... | 617 |
| FRANalysis:MARKer<m>:GAIN?..... | 617 |
| FRANalysis:MARKer<m>:PHASe?..... | 617 |
| FRANalysis:MARKer<m>:SSCReen..... | 617 |
| FRANalysis:MARKer<m>:STATe..... | 616 |
| FRANalysis:MEASurement:DELay:STATe..... | 606 |
| FRANalysis:MEASurement:DELay[:TIME]..... | 606 |
| FRANalysis:MEASurement:POINt[:DISPlay]..... | 606 |
| FRANalysis:MEASurement:RBW..... | 607 |
| FRANalysis:OUTPut[:SOURce]..... | 607 |
| FRANalysis:PHASe:DATA?..... | 614 |
| FRANalysis:PHASe:ENABle..... | 612 |
| FRANalysis:PHASe:MAXimum..... | 608 |
| FRANalysis:PHASe:OFFSet..... | 612 |
| FRANalysis:PHASe:SCALe..... | 612 |
| FRANalysis:POINts:LOGarithmic..... | 607 |
| FRANalysis:POINts:MODE..... | 607 |
| FRANalysis:POINts:TOTal..... | 608 |
| FRANalysis:REPeat..... | 608 |
| FRANalysis:RESet..... | 608 |
| FRANalysis:RESult:STATe..... | 615 |
| FRANalysis:STATe..... | 603 |
| GATE<g>:ABSolute:START..... | 570 |
| GATE<g>:ABSolute:STOP..... | 570 |
| GATE<g>:CURSor..... | 569 |
| GATE<g>:ENABle..... | 568 |
| GATE<g>:GCOupling..... | 568 |
| GATE<g>:MODE..... | 569 |
| GATE<g>:RELative:START..... | 570 |
| GATE<g>:RELative:STOP..... | 570 |
| GATE<g>:SHOW..... | 570 |
| GATE<g>:ZDIagram..... | 569 |
| GENerator:RCL..... | 550 |
| GENerator:SAV..... | 550 |
| GENerator:SYNC[:COMBination]..... | 780 |
| HCOPY:DESTination<m>..... | 555 |
| HCOPY:DEVice<m>:INVerse..... | 555 |
| HCOPY:DEVice<m>:LANGuage..... | 555 |

| | |
|---|-----|
| HCOPY:IMMEDIATE<m>:NEXT..... | 556 |
| HCOPY:IMMEDIATE<m>[:DUM]..... | 556 |
| HCOPY:ISBA..... | 556 |
| HCOPY:SSD..... | 557 |
| HCOPY:WBKG..... | 557 |
| HDEFINITION:BWIDTh..... | 491 |
| HDEFINITION:RESOLUTION?..... | 491 |
| HDEFINITION:STATe..... | 491 |
| LAYOUT<ly>:ACTive..... | 444 |
| LAYOUT<ly>:COUNT?..... | 444 |
| LAYOUT<ly>:DIAGRAM<da>:COUNT?..... | 445 |
| LAYOUT<ly>:DIAGRAM<da>:LABEl..... | 446 |
| LAYOUT<ly>:DIAGRAM<da>:SOURce..... | 446 |
| LAYOUT<ly>:DIAGRAM<da>[:ENABle]..... | 445 |
| LAYOUT<ly>:LABEl..... | 445 |
| LAYOUT<ly>:NODE<no>:CHILDREN<o>:CONTent<p>:ID..... | 447 |
| LAYOUT<ly>:NODE<no>:CHILDREN<o>:CONTent<p>:TYPE..... | 447 |
| LAYOUT<ly>:NODE<no>:COUNT?..... | 446 |
| LAYOUT<ly>:NODE<no>:RATio..... | 448 |
| LAYOUT<ly>:NODE<no>:STYPe..... | 448 |
| LAYOUT<ly>:NODE<no>[:ENABle]..... | 447 |
| LAYOUT<ly>:SACTive..... | 445 |
| LAYOUT<ly>:ZOOM<zo>:COUNT?..... | 519 |
| LAYOUT<ly>:ZOOM<zo>:HORIZONTAL:ABSolute:POSition..... | 519 |
| LAYOUT<ly>:ZOOM<zo>:HORIZONTAL:ABSolute:SPAN..... | 520 |
| LAYOUT<ly>:ZOOM<zo>:HORIZONTAL:ABSolute:START..... | 520 |
| LAYOUT<ly>:ZOOM<zo>:HORIZONTAL:ABSolute:STOP..... | 520 |
| LAYOUT<ly>:ZOOM<zo>:HORIZONTAL:ABSolute:WIDTh..... | 521 |
| LAYOUT<ly>:ZOOM<zo>:HORIZONTAL:MODE..... | 521 |
| LAYOUT<ly>:ZOOM<zo>:HORIZONTAL:RELative:POSition..... | 521 |
| LAYOUT<ly>:ZOOM<zo>:HORIZONTAL:RELative:SPAN..... | 522 |
| LAYOUT<ly>:ZOOM<zo>:HORIZONTAL:RELative:START..... | 522 |
| LAYOUT<ly>:ZOOM<zo>:HORIZONTAL:RELative:STOP..... | 522 |
| LAYOUT<ly>:ZOOM<zo>:HORIZONTAL:RELative:WIDTh..... | 523 |
| LAYOUT<ly>:ZOOM<zo>:SOURce..... | 523 |
| LAYOUT<ly>:ZOOM<zo>:VERTical:ABSolute:POSition..... | 523 |
| LAYOUT<ly>:ZOOM<zo>:VERTical:ABSolute:RANGe..... | 524 |
| LAYOUT<ly>:ZOOM<zo>:VERTical:ABSolute:SPAN..... | 524 |
| LAYOUT<ly>:ZOOM<zo>:VERTical:ABSolute:START..... | 524 |
| LAYOUT<ly>:ZOOM<zo>:VERTical:ABSolute:STOP..... | 524 |
| LAYOUT<ly>:ZOOM<zo>:VERTical:MODE..... | 525 |
| LAYOUT<ly>:ZOOM<zo>:VERTical:RELative:POSition..... | 525 |
| LAYOUT<ly>:ZOOM<zo>:VERTical:RELative:SPAN..... | 526 |
| LAYOUT<ly>:ZOOM<zo>:VERTical:RELative:START..... | 525 |
| LAYOUT<ly>:ZOOM<zo>:VERTical:RELative:STOP..... | 526 |
| LAYOUT<ly>:ZOOM<zo>:VERTical:RELative:WIDTh..... | 526 |
| LAYOUT<ly>:ZOOM<zo>[:ENABle]..... | 519 |
| LAYOUT<ly>[:ENABle]..... | 444 |
| MEASUREMENT<mg>:AMPTime:CSLoPe..... | 560 |
| MEASUREMENT<mg>:AMPTime:DELay<n>:DIRectioN..... | 561 |

| | |
|---|-----|
| MEASurement<mg>:AMPTime:DElay<n>:SLOPe..... | 562 |
| MEASurement<mg>:AMPTime:DTOTrigger<n>:SLOPe..... | 562 |
| MEASurement<mg>:AMPTime:ESLOpe..... | 560 |
| MEASurement<mg>:AMPTime:PSLOpe..... | 561 |
| MEASurement<mg>:AMPTime:PTCount..... | 561 |
| MEASurement<mg>:COUNT?..... | 558 |
| MEASurement<mg>:ENVSelect..... | 559 |
| MEASurement<mg>:FSRC..... | 558 |
| MEASurement<mg>:GATE..... | 563 |
| MEASurement<mg>:IMPRecise:STATus:CONDition?..... | 784 |
| MEASurement<mg>:IMPRecise:STATus:ENABle..... | 785 |
| MEASurement<mg>:IMPRecise:STATus:NTRansition..... | 786 |
| MEASurement<mg>:IMPRecise:STATus:PTRansition..... | 787 |
| MEASurement<mg>:IMPRecise:STATus[:EVENT]?..... | 785 |
| MEASurement<mg>:LIMit:STATus:CONDition?..... | 784 |
| MEASurement<mg>:LIMit:STATus:ENABle..... | 785 |
| MEASurement<mg>:LIMit:STATus:NTRansition..... | 786 |
| MEASurement<mg>:LIMit:STATus:PTRansition..... | 787 |
| MEASurement<mg>:LIMit:STATus[:EVENT]?..... | 785 |
| MEASurement<mg>:MAIN..... | 559 |
| MEASurement<mg>:MARGin:STATus:CONDition?..... | 784 |
| MEASurement<mg>:MARGin:STATus:ENABle..... | 785 |
| MEASurement<mg>:MARGin:STATus:NTRansition..... | 786 |
| MEASurement<mg>:MARGin:STATus:PTRansition..... | 787 |
| MEASurement<mg>:MARGin:STATus[:EVENT]?..... | 785 |
| MEASurement<mg>:MNOMeas..... | 567 |
| MEASurement<mg>:MULTiple..... | 567 |
| MEASurement<mg>:REFLevel<sc>:REFerence..... | 563 |
| MEASurement<mg>:RESult:AVG?..... | 564 |
| MEASurement<mg>:RESult:EVENTs:COUNT?..... | 565 |
| MEASurement<mg>:RESult:EVENTs:START?..... | 565 |
| MEASurement<mg>:RESult:EVENTs:STOP?..... | 565 |
| MEASurement<mg>:RESult:EVENTs:VALue?..... | 566 |
| MEASurement<mg>:RESult:EVTCount?..... | 564 |
| MEASurement<mg>:RESult:NPEak?..... | 564 |
| MEASurement<mg>:RESult:PPEak?..... | 564 |
| MEASurement<mg>:RESult:RELIability?..... | 564 |
| MEASurement<mg>:RESult:RMS?..... | 564 |
| MEASurement<mg>:RESult:START?..... | 564 |
| MEASurement<mg>:RESult:STDDev?..... | 564 |
| MEASurement<mg>:RESult:STOP?..... | 564 |
| MEASurement<mg>:RESult:WFMCount?..... | 564 |
| MEASurement<mg>:RESult[:ACTual]?..... | 564 |
| MEASurement<mg>:SOURce..... | 558 |
| MEASurement<mg>:SSRC..... | 559 |
| MEASurement<mg>:STATistics:ARESet..... | 566 |
| MEASurement<mg>:STATistics[:ENABle]..... | 567 |
| MEASurement<mg>:TRACK:AUTO..... | 575 |
| MEASurement<mg>:TRACK:CONTiuous..... | 575 |
| MEASurement<mg>:TRACK:DATA:HEADer?..... | 576 |

| | |
|--------------------------------------|-----|
| MEASurement<mg>:TRACk:DATA[:VALues]? | 577 |
| MEASurement<mg>:TRACk:OFFSet | 576 |
| MEASurement<mg>:TRACk:SCALe | 576 |
| MEASurement<mg>:TRACk[:STATe] | 575 |
| MEASurement<mg>[:ENABle] | 558 |
| METer: BANDwidth | 642 |
| METer: DVMeter<m>:ACRMs:ENABle | 642 |
| METer: DVMeter<m>:ACRMs:RESult? | 642 |
| METer: DVMeter<m>:DC:ENABle | 643 |
| METer: DVMeter<m>:DC:RESult? | 643 |
| METer: DVMeter<m>:DCRMs:ENABle | 643 |
| METer: DVMeter<m>:DCRMs:RESult? | 644 |
| METer: DVMeter<m>:ENABle? | 641 |
| MMEMory: ATTRibute | 548 |
| MMEMory: AUSave:ENABle | 457 |
| MMEMory: AUSave:INTerval | 457 |
| MMEMory: AUTonaming: DEFaultpath | 458 |
| MMEMory: AUTonaming: INDex | 456 |
| MMEMory: AUTonaming: PREFix | 456 |
| MMEMory: AUTonaming: RESall | 458 |
| MMEMory: AUTonaming: RESPath | 458 |
| MMEMory: AUTonaming: TEXT | 458 |
| MMEMory: AUTonaming: TIME | 456 |
| MMEMory: AUTonaming: USERtext | 457 |
| MMEMory: CATalog: LENGth? | 546 |
| MMEMory: CATalog? | 545 |
| MMEMory: CDIRectory | 545 |
| MMEMory: COPY | 546 |
| MMEMory: DATA | 547 |
| MMEMory: DCATalog: LENGth? | 544 |
| MMEMory: DCATalog? | 544 |
| MMEMory: DELeTe | 547 |
| MMEMory: DRIVes? | 544 |
| MMEMory: GENErator: RCL | 549 |
| MMEMory: GENErator: SAV | 550 |
| MMEMory: LOAD: STATe | 549 |
| MMEMory: MDIRectory | 545 |
| MMEMory: MOVE | 547 |
| MMEMory: NAME | 555 |
| MMEMory: RCL | 549 |
| MMEMory: RDIRectory | 545 |
| MMEMory: SAV | 548 |
| MMEMory: STORe: STATe | 549 |
| PBUS<pb>: BIT<n>: LABel | 752 |
| PBUS<pb>: BIT<n>: SKEW | 752 |
| PBUS<pb>: BIT<n>[: STATe] | 753 |
| PBUS<pb>: CLEar | 753 |
| PBUS<pb>: CLOCK | 753 |
| PBUS<pb>: CLON | 754 |
| PBUS<pb>: CLSLope | 754 |

| | |
|---|-----|
| PBUS<pb>:DATA:FORMat..... | 760 |
| PBUS<pb>:DATA:HEADer?..... | 760 |
| PBUS<pb>:DATA[:VALues]?..... | 761 |
| PBUS<pb>:DIGSignals:POSition..... | 754 |
| PBUS<pb>:DIGSignals:SCALe..... | 755 |
| PBUS<pb>:DISPlay:SHBU..... | 755 |
| PBUS<pb>:DISPlay:SHDI..... | 755 |
| PBUS<pb>:HYSTeresis<n>..... | 756 |
| PBUS<pb>:POSition..... | 756 |
| PBUS<pb>:SCALe..... | 756 |
| PBUS<pb>:SKEW..... | 757 |
| PBUS<pb>:STATe..... | 757 |
| PBUS<pb>:TECHnology..... | 757 |
| PBUS<pb>:THCOupling..... | 758 |
| PBUS<pb>:THReshold<n>..... | 758 |
| POWer<m>:ASKew[:EXECute]..... | 620 |
| POWer<m>:HARMonics:AVAILable?..... | 631 |
| POWer<m>:HARMonics:DISPlay:FREQuency:START..... | 630 |
| POWer<m>:HARMonics:DISPlay:FREQuency:STOP..... | 631 |
| POWer<m>:HARMonics:FREQuency:EN..... | 629 |
| POWer<m>:HARMonics:FREQuency:MIL..... | 630 |
| POWer<m>:HARMonics:FREQuency:RTCA..... | 630 |
| POWer<m>:HARMonics:MEASurement:FREQuency[:ACTual]?..... | 632 |
| POWer<m>:HARMonics:MEASurement:FREQuency[:ACTual]?..... | 634 |
| POWer<m>:HARMonics:MEASurement:REALpower[:ACTual]?..... | 632 |
| POWer<m>:HARMonics:MEASurement:REALpower[:ACTual]?..... | 635 |
| POWer<m>:HARMonics:MEASurement:THDFundament[:ACTual]?..... | 631 |
| POWer<m>:HARMonics:MEASurement:THDRms[:ACTual]?..... | 631 |
| POWer<m>:HARMonics:POWer:DATA:HEADer?..... | 639 |
| POWer<m>:HARMonics:POWer:DATA[:VALues]..... | 640 |
| POWer<m>:HARMonics:REFLevel<rl>:ABSolute:HYSTeresis..... | 635 |
| POWer<m>:HARMonics:REFLevel<rl>:ABSolute:LLEVel..... | 636 |
| POWer<m>:HARMonics:REFLevel<rl>:ABSolute:MLEVel..... | 636 |
| POWer<m>:HARMonics:REFLevel<rl>:ABSolute:ULEVel..... | 636 |
| POWer<m>:HARMonics:REFLevel<rl>:LMODE..... | 637 |
| POWer<m>:HARMonics:REFLevel<rl>:RELative:HYSTeresis..... | 637 |
| POWer<m>:HARMonics:REFLevel<rl>:RELative:LOWer..... | 638 |
| POWer<m>:HARMonics:REFLevel<rl>:RELative:MIDDLE..... | 638 |
| POWer<m>:HARMonics:REFLevel<rl>:RELative:MODE..... | 638 |
| POWer<m>:HARMonics:REFLevel<rl>:RELative:UPPer..... | 639 |
| POWer<m>:HARMonics:RESult<n>:MAGNitude:PERCent:MAXimum?..... | 633 |
| POWer<m>:HARMonics:RESult<n>:MAGNitude:PERCent:MINimum?..... | 633 |
| POWer<m>:HARMonics:RESult<n>:MAGNitude:PERCent[:ACTual]?..... | 633 |
| POWer<m>:HARMonics:RESult<n>:MAGNitude:RMS:MAXimum?..... | 634 |
| POWer<m>:HARMonics:RESult<n>:MAGNitude:RMS:MINimum?..... | 634 |
| POWer<m>:HARMonics:RESult<n>:MAGNitude:RMS[:ACTual]?..... | 634 |
| POWer<m>:HARMonics:RESult<n>:VIOLation?..... | 632 |
| POWer<m>:HARMonics:RESult<n>[:FREQuency]?..... | 632 |
| POWer<m>:HARMonics:SOURce:CURREnt..... | 628 |
| POWer<m>:HARMonics:SOURce[:VOLTage]..... | 629 |

| | |
|--|-----|
| POWer<m>:HARMonics:STANdard..... | 629 |
| POWer<m>:HARMonics:STATistics:RESet..... | 630 |
| POWer<m>:QUALity:FREQuency:USER..... | 621 |
| POWer<m>:QUALity:FREQuency[:VALue]..... | 621 |
| POWer<m>:QUALity:POWer:DATA:HEADer?..... | 640 |
| POWer<m>:QUALity:POWer:DATA[:VALues]?..... | 641 |
| POWer<m>:QUALity:REFLevel<rl>:ABSolute:HYSTEResis..... | 635 |
| POWer<m>:QUALity:REFLevel<rl>:ABSolute:LLEVel..... | 636 |
| POWer<m>:QUALity:REFLevel<rl>:ABSolute:MLeVel..... | 636 |
| POWer<m>:QUALity:REFLevel<rl>:ABSolute:ULeVel..... | 636 |
| POWer<m>:QUALity:REFLevel<rl>:LMODE..... | 637 |
| POWer<m>:QUALity:REFLevel<rl>:RELative:HYSTEResis..... | 637 |
| POWer<m>:QUALity:REFLevel<rl>:RELative:LOWer..... | 638 |
| POWer<m>:QUALity:REFLevel<rl>:RELative:MIDDLE..... | 638 |
| POWer<m>:QUALity:REFLevel<rl>:RELative:MODE..... | 638 |
| POWer<m>:QUALity:REFLevel<rl>:RELative:UPPer..... | 639 |
| POWer<m>:QUALity:RESult:CURRent:CREStfactor:AVErAge?..... | 623 |
| POWer<m>:QUALity:RESult:CURRent:CREStfactor:NPEak?..... | 623 |
| POWer<m>:QUALity:RESult:CURRent:CREStfactor:PPEak?..... | 623 |
| POWer<m>:QUALity:RESult:CURRent:CREStfactor:RMS?..... | 623 |
| POWer<m>:QUALity:RESult:CURRent:CREStfactor:STDDev?..... | 623 |
| POWer<m>:QUALity:RESult:CURRent:CREStfactor[:ACTual]?..... | 623 |
| POWer<m>:QUALity:RESult:CURRent:PEAK:AVErAge?..... | 623 |
| POWer<m>:QUALity:RESult:CURRent:PEAK:NPEak?..... | 623 |
| POWer<m>:QUALity:RESult:CURRent:PEAK:PPEak?..... | 624 |
| POWer<m>:QUALity:RESult:CURRent:PEAK:RMS?..... | 624 |
| POWer<m>:QUALity:RESult:CURRent:PEAK:STDDev?..... | 624 |
| POWer<m>:QUALity:RESult:CURRent:PEAK[:ACTual]?..... | 623 |
| POWer<m>:QUALity:RESult:CURRent:RMS:AVErAge?..... | 624 |
| POWer<m>:QUALity:RESult:CURRent:RMS:NPEak?..... | 624 |
| POWer<m>:QUALity:RESult:CURRent:RMS:PPEak?..... | 624 |
| POWer<m>:QUALity:RESult:CURRent:RMS:RMS?..... | 624 |
| POWer<m>:QUALity:RESult:CURRent:RMS:STDDev?..... | 624 |
| POWer<m>:QUALity:RESult:CURRent:RMS[:ACTual]?..... | 624 |
| POWer<m>:QUALity:RESult:POWer:APParent:AVErAge?..... | 624 |
| POWer<m>:QUALity:RESult:POWer:APParent:NPEak?..... | 624 |
| POWer<m>:QUALity:RESult:POWer:APParent:PPEak?..... | 624 |
| POWer<m>:QUALity:RESult:POWer:APParent:RMS?..... | 624 |
| POWer<m>:QUALity:RESult:POWer:APParent:STDDev?..... | 624 |
| POWer<m>:QUALity:RESult:POWer:APParent[:ACTual]?..... | 624 |
| POWer<m>:QUALity:RESult:POWer:PFACtor:AVErAge?..... | 625 |
| POWer<m>:QUALity:RESult:POWer:PFACtor:NPEak?..... | 625 |
| POWer<m>:QUALity:RESult:POWer:PFACtor:PPEak?..... | 625 |
| POWer<m>:QUALity:RESult:POWer:PFACtor:RMS?..... | 625 |
| POWer<m>:QUALity:RESult:POWer:PFACtor:STDDev?..... | 625 |
| POWer<m>:QUALity:RESult:POWer:PFACtor[:ACTual]?..... | 625 |
| POWer<m>:QUALity:RESult:POWer:PHASe:AVErAge?..... | 625 |
| POWer<m>:QUALity:RESult:POWer:PHASe:NPEak?..... | 625 |
| POWer<m>:QUALity:RESult:POWer:PHASe:PPEak?..... | 625 |
| POWer<m>:QUALity:RESult:POWer:PHASe:RMS?..... | 625 |

| | |
|---|-----|
| POWer<m>:QUALity:RESult:POWer:PHASe:STDDev? | 625 |
| POWer<m>:QUALity:RESult:POWer:PHASe[:ACTual]? | 625 |
| POWer<m>:QUALity:RESult:POWer:REACTive:AVERage? | 626 |
| POWer<m>:QUALity:RESult:POWer:REACTive:NPEak? | 626 |
| POWer<m>:QUALity:RESult:POWer:REACTive:PPEak? | 626 |
| POWer<m>:QUALity:RESult:POWer:REACTive:RMS? | 626 |
| POWer<m>:QUALity:RESult:POWer:REACTive:STDDev? | 626 |
| POWer<m>:QUALity:RESult:POWer:REACTive[:ACTual]? | 626 |
| POWer<m>:QUALity:RESult:POWer:REALpower:AVERage? | 626 |
| POWer<m>:QUALity:RESult:POWer:REALpower:NPEak? | 626 |
| POWer<m>:QUALity:RESult:POWer:REALpower:PPEak? | 626 |
| POWer<m>:QUALity:RESult:POWer:REALpower:RMS? | 626 |
| POWer<m>:QUALity:RESult:POWer:REALpower:STDDev? | 626 |
| POWer<m>:QUALity:RESult:POWer:REALpower[:ACTual]? | 626 |
| POWer<m>:QUALity:RESult:VOLTagE:CREStfactor:AVERage? | 626 |
| POWer<m>:QUALity:RESult:VOLTagE:CREStfactor:NPEak? | 626 |
| POWer<m>:QUALity:RESult:VOLTagE:CREStfactor:PPEak? | 626 |
| POWer<m>:QUALity:RESult:VOLTagE:CREStfactor:RMS? | 626 |
| POWer<m>:QUALity:RESult:VOLTagE:CREStfactor:STDDev? | 626 |
| POWer<m>:QUALity:RESult:VOLTagE:CREStfactor[:ACTual]? | 626 |
| POWer<m>:QUALity:RESult:VOLTagE:FREQUency:AVERage? | 627 |
| POWer<m>:QUALity:RESult:VOLTagE:FREQUency:NPEak? | 627 |
| POWer<m>:QUALity:RESult:VOLTagE:FREQUency:PPEak? | 627 |
| POWer<m>:QUALity:RESult:VOLTagE:FREQUency:RMS? | 627 |
| POWer<m>:QUALity:RESult:VOLTagE:FREQUency:STDDev? | 627 |
| POWer<m>:QUALity:RESult:VOLTagE:FREQUency[:ACTual]? | 627 |
| POWer<m>:QUALity:RESult:VOLTagE:PEAK:AVERage? | 627 |
| POWer<m>:QUALity:RESult:VOLTagE:PEAK:NPEak? | 627 |
| POWer<m>:QUALity:RESult:VOLTagE:PEAK:PPEak? | 627 |
| POWer<m>:QUALity:RESult:VOLTagE:PEAK:RMS? | 627 |
| POWer<m>:QUALity:RESult:VOLTagE:PEAK:STDDev? | 627 |
| POWer<m>:QUALity:RESult:VOLTagE:PEAK[:ACTual]? | 627 |
| POWer<m>:QUALity:RESult:VOLTagE:RMS:AVERage? | 628 |
| POWer<m>:QUALity:RESult:VOLTagE:RMS:NPEak? | 628 |
| POWer<m>:QUALity:RESult:VOLTagE:RMS:PPEak? | 628 |
| POWer<m>:QUALity:RESult:VOLTagE:RMS:RMS? | 628 |
| POWer<m>:QUALity:RESult:VOLTagE:RMS:STDDev? | 628 |
| POWer<m>:QUALity:RESult:VOLTagE:RMS[:ACTual]? | 628 |
| POWer<m>:QUALity:SOURce:CURRent | 620 |
| POWer<m>:QUALity:SOURce[:VOLTagE] | 621 |
| POWer<m>:TYPE | 619 |
| POWer<m>[:ENABLE] | 619 |
| PROBe<ch>:ID:PARTnumber? | 489 |
| PROBe<ch>:ID:PRDate? | 489 |
| PROBe<ch>:ID:SRNumber? | 489 |
| PROBe<ch>:ID:SWVersion? | 490 |
| PROBe<ch>:PMETer:RESults:COMMon? | 484 |
| PROBe<ch>:PMETer:RESults:DIFFerential? | 484 |
| PROBe<ch>:PMETer:RESults:NEGative? | 485 |
| PROBe<ch>:PMETer:RESults:POSitive? | 485 |

| | |
|---|-----|
| PROBe<ch>:PMETer:RESults:SINGle?..... | 484 |
| PROBe<ch>:PMETer:STATe..... | 483 |
| PROBe<ch>:SETup:ACCoupling..... | 482 |
| PROBe<ch>:SETup:ADVanced:AUDioverload..... | 486 |
| PROBe<ch>:SETup:ADVanced:FILTer..... | 486 |
| PROBe<ch>:SETup:ADVanced:PMToffset..... | 487 |
| PROBe<ch>:SETup:ADVanced:RANGe..... | 486 |
| PROBe<ch>:SETup:ATTenuation:DEFProbe..... | 477 |
| PROBe<ch>:SETup:ATTenuation:MANual..... | 477 |
| PROBe<ch>:SETup:ATTenuation:UNIT..... | 478 |
| PROBe<ch>:SETup:ATTenuation[:AUTO]?..... | 477 |
| PROBe<ch>:SETup:BANDwidth?..... | 478 |
| PROBe<ch>:SETup:CAPacitance?..... | 490 |
| PROBe<ch>:SETup:CMOFFset..... | 482 |
| PROBe<ch>:SETup:DEGAuss..... | 488 |
| PROBe<ch>:SETup:DISPlaydiff..... | 483 |
| PROBe<ch>:SETup:GAIN:AUTO?..... | 487 |
| PROBe<ch>:SETup:GAIN:MANual..... | 487 |
| PROBe<ch>:SETup:IMPedance?..... | 490 |
| PROBe<ch>:SETup:MODE..... | 481 |
| PROBe<ch>:SETup:NAME?..... | 480 |
| PROBe<ch>:SETup:OFFSet:AZERo..... | 479 |
| PROBe<ch>:SETup:OFFSet:STPRobe..... | 488 |
| PROBe<ch>:SETup:OFFSet:TOMean..... | 479 |
| PROBe<ch>:SETup:OFFSet:USEautozero..... | 479 |
| PROBe<ch>:SETup:OFFSet:ZADJust..... | 488 |
| PROBe<ch>:SETup:STATe?..... | 480 |
| PROBe<ch>:SETup:TYPE?..... | 480 |
| PROBe<ch>:SETup:ZAXV..... | 483 |
| REFCurve<rc>:ABORt..... | 534 |
| REFCurve<rc>:AXIS[:XMODE]..... | 537 |
| REFCurve<rc>:CLEar..... | 534 |
| REFCurve<rc>:DATA:HEADer?..... | 542 |
| REFCurve<rc>:DATA:STYPe?..... | 541 |
| REFCurve<rc>:DATA[:VALues]?..... | 542 |
| REFCurve<rc>:HMODE..... | 538 |
| REFCurve<rc>:NAME..... | 535 |
| REFCurve<rc>:OFFSet..... | 535 |
| REFCurve<rc>:OPEN..... | 535 |
| REFCurve<rc>:POSition..... | 538 |
| REFCurve<rc>:RESCale:HORIZontal:FACtor..... | 538 |
| REFCurve<rc>:RESCale:HORIZontal:OFFSet..... | 539 |
| REFCurve<rc>:RESCale:HORIZontal:STATe..... | 539 |
| REFCurve<rc>:RESCale:VERTical:FACtor..... | 539 |
| REFCurve<rc>:RESCale:VERTical:OFFSet..... | 540 |
| REFCurve<rc>:RESCale:VERTical:STATe..... | 540 |
| REFCurve<rc>:RESTore..... | 535 |
| REFCurve<rc>:SAVE..... | 536 |
| REFCurve<rc>:SCALE..... | 537 |
| REFCurve<rc>:SOURce..... | 536 |

| | |
|--|-----|
| REFCurve<rc>:STATe..... | 536 |
| REFCurve<rc>:TOORiginal..... | 540 |
| REFCurve<rc>:UPDate..... | 537 |
| REFCurve<rc>:VMODE..... | 541 |
| REFLevel<rl>:ABSolute:HYSteresis..... | 571 |
| REFLevel<rl>:ABSolute:LLEVel..... | 572 |
| REFLevel<rl>:ABSolute:MLEVel..... | 572 |
| REFLevel<rl>:ABSolute:ULEVel..... | 572 |
| REFLevel<rl>:ENABle..... | 571 |
| REFLevel<rl>:LMODE..... | 571 |
| REFLevel<rl>:RELative:HYSteresis..... | 573 |
| REFLevel<rl>:RELative:LOWer..... | 573 |
| REFLevel<rl>:RELative:MIDDLE..... | 573 |
| REFLevel<rl>:RELative:MODE..... | 574 |
| REFLevel<rl>:RELative:UPPer..... | 574 |
| RUN..... | 460 |
| RUNCont..... | 460 |
| RUNSingle..... | 460 |
| SAVeset:CONFig:PREView..... | 550 |
| SBUS<m>:CAN:FRAMe<fr>:XDAta<o>:SBC?..... | 729 |
| SBUS<m>:SETReflevels..... | 646 |
| SBUS<m>:THReshold..... | 646 |
| SBUS<m>:UART:EWORd..... | 687 |
| SBUS<m>:ZCOupling..... | 646 |
| SBUS<sb>:CAN:BITRate..... | 701 |
| SBUS<sb>:CAN:FAST:HYSteresis..... | 704 |
| SBUS<sb>:CAN:FAST:THReshold..... | 703 |
| SBUS<sb>:CAN:FCOunt?..... | 720 |
| SBUS<sb>:CAN:FDAta:DBITRate..... | 702 |
| SBUS<sb>:CAN:FDAta:SAMplepoint..... | 702 |
| SBUS<sb>:CAN:FILTer:BIT..... | 716 |
| SBUS<sb>:CAN:FILTer:DMAX..... | 716 |
| SBUS<sb>:CAN:FILTer:DMIN..... | 716 |
| SBUS<sb>:CAN:FILTer:DOPerator..... | 717 |
| SBUS<sb>:CAN:FILTer:ENABle..... | 715 |
| SBUS<sb>:CAN:FILTer:ERENable..... | 717 |
| SBUS<sb>:CAN:FILTer:ERRor<n>:ENABle..... | 717 |
| SBUS<sb>:CAN:FILTer:FIENable..... | 717 |
| SBUS<sb>:CAN:FILTer:FRAMe<fr>:ENABle..... | 718 |
| SBUS<sb>:CAN:FILTer:FRAMe<fr>:FLD<fl>:BIT..... | 716 |
| SBUS<sb>:CAN:FILTer:FRAMe<fr>:FLD<fl>:DMAX..... | 716 |
| SBUS<sb>:CAN:FILTer:FRAMe<fr>:FLD<fl>:DMIN..... | 716 |
| SBUS<sb>:CAN:FILTer:FRAMe<fr>:FLD<fl>:DOPerator..... | 717 |
| SBUS<sb>:CAN:FILTer:FRAMe<fr>:FLD<fl>:ENABle..... | 717 |
| SBUS<sb>:CAN:FILTer:FRAMe<fr>:FLD<fl>:IMAX..... | 718 |
| SBUS<sb>:CAN:FILTer:FRAMe<fr>:FLD<fl>:IMIN..... | 718 |
| SBUS<sb>:CAN:FILTer:FRAMe<fr>:FLD<fl>:IOPerator..... | 719 |
| SBUS<sb>:CAN:FILTer:FRENable..... | 718 |
| SBUS<sb>:CAN:FILTer:IMAX..... | 718 |
| SBUS<sb>:CAN:FILTer:IMIN..... | 718 |

| | |
|--|-----|
| SBUS<sb>:CAN:FILTer:IOPerator..... | 719 |
| SBUS<sb>:CAN:FRAMe<fr>:ACKState?..... | 720 |
| SBUS<sb>:CAN:FRAMe<fr>:ACKValue?..... | 721 |
| SBUS<sb>:CAN:FRAMe<fr>:BSEPosition?..... | 721 |
| SBUS<sb>:CAN:FRAMe<fr>:BYTE<o>:STATe?..... | 721 |
| SBUS<sb>:CAN:FRAMe<fr>:BYTE<o>:VALue?..... | 722 |
| SBUS<sb>:CAN:FRAMe<fr>:COUNT?..... | 732 |
| SBUS<sb>:CAN:FRAMe<fr>:CSSTate?..... | 722 |
| SBUS<sb>:CAN:FRAMe<fr>:CSValue?..... | 722 |
| SBUS<sb>:CAN:FRAMe<fr>:DATA?..... | 723 |
| SBUS<sb>:CAN:FRAMe<fr>:DBITRate?..... | 731 |
| SBUS<sb>:CAN:FRAMe<fr>:DLCState?..... | 723 |
| SBUS<sb>:CAN:FRAMe<fr>:DLCValue?..... | 723 |
| SBUS<sb>:CAN:FRAMe<fr>:FDATa<o>:BRS?..... | 731 |
| SBUS<sb>:CAN:FRAMe<fr>:FDATa<o>:ESI?..... | 731 |
| SBUS<sb>:CAN:FRAMe<fr>:FERCause?..... | 724 |
| SBUS<sb>:CAN:FRAMe<fr>:IDState?..... | 724 |
| SBUS<sb>:CAN:FRAMe<fr>:IDType?..... | 724 |
| SBUS<sb>:CAN:FRAMe<fr>:IDValue?..... | 725 |
| SBUS<sb>:CAN:FRAMe<fr>:NBITRate?..... | 732 |
| SBUS<sb>:CAN:FRAMe<fr>:NDBYtes?..... | 725 |
| SBUS<sb>:CAN:FRAMe<fr>:PDATa?..... | 725 |
| SBUS<sb>:CAN:FRAMe<fr>:SBC?..... | 732 |
| SBUS<sb>:CAN:FRAMe<fr>:SDATa?..... | 726 |
| SBUS<sb>:CAN:FRAMe<fr>:SDEXport?..... | 726 |
| SBUS<sb>:CAN:FRAMe<fr>:START?..... | 726 |
| SBUS<sb>:CAN:FRAMe<fr>:STATus?..... | 726 |
| SBUS<sb>:CAN:FRAMe<fr>:STOP?..... | 727 |
| SBUS<sb>:CAN:FRAMe<fr>:STUFF?..... | 727 |
| SBUS<sb>:CAN:FRAMe<fr>:SYMBol?..... | 728 |
| SBUS<sb>:CAN:FRAMe<fr>:TYPE?..... | 728 |
| SBUS<sb>:CAN:FRAMe<fr>:XDATa<o>:AF?..... | 728 |
| SBUS<sb>:CAN:FRAMe<fr>:XDATa<o>:FCRC?..... | 732 |
| SBUS<sb>:CAN:FRAMe<fr>:XDATa<o>:PCRC?..... | 729 |
| SBUS<sb>:CAN:FRAMe<fr>:XDATa<o>:SDT?..... | 729 |
| SBUS<sb>:CAN:FRAMe<fr>:XDATa<o>:SEC?..... | 730 |
| SBUS<sb>:CAN:FRAMe<fr>:XDATa<o>:VCID?..... | 730 |
| SBUS<sb>:CAN:NEWList..... | 705 |
| SBUS<sb>:CAN:POStion..... | 705 |
| SBUS<sb>:CAN:SAMPlepoint..... | 702 |
| SBUS<sb>:CAN:SCALe..... | 706 |
| SBUS<sb>:CAN:SIC:HYSTeresis..... | 703 |
| SBUS<sb>:CAN:SIC:THReshold..... | 703 |
| SBUS<sb>:CAN:SOURce..... | 702 |
| SBUS<sb>:CAN:SYMBols..... | 705 |
| SBUS<sb>:CAN:TRCVmode..... | 704 |
| SBUS<sb>:CAN:TYPE..... | 701 |
| SBUS<sb>:CAN:XDATa:DBITRate..... | 704 |
| SBUS<sb>:CAN:XDATa:SAMPlepoint..... | 704 |
| SBUS<sb>:EXPResult:DETail..... | 647 |

| | |
|--|-----|
| SBUS<sb>:EXPRResult:EXTension..... | 648 |
| SBUS<sb>:EXPRResult:PATH..... | 648 |
| SBUS<sb>:EXPRResult:SAVE..... | 647 |
| SBUS<sb>:EXPRResult:TIME..... | 647 |
| SBUS<sb>:FORMat..... | 645 |
| SBUS<sb>:I2C:FCOunt?..... | 678 |
| SBUS<sb>:I2C:FILTer:BIT..... | 677 |
| SBUS<sb>:I2C:FILTer:DMAX..... | 674 |
| SBUS<sb>:I2C:FILTer:DMIN..... | 675 |
| SBUS<sb>:I2C:FILTer:DOPerator..... | 675 |
| SBUS<sb>:I2C:FILTer:ENABle..... | 674 |
| SBUS<sb>:I2C:FILTer:ERENable..... | 675 |
| SBUS<sb>:I2C:FILTer:ERRor<n>:ENABle..... | 675 |
| SBUS<sb>:I2C:FILTer:FIENable..... | 677 |
| SBUS<sb>:I2C:FILTer:FRAMe<fr>:ENABle..... | 674 |
| SBUS<sb>:I2C:FILTer:FRAMe<fr>:FLD<fl>:BIT..... | 677 |
| SBUS<sb>:I2C:FILTer:FRAMe<fr>:FLD<fl>:DMAX..... | 674 |
| SBUS<sb>:I2C:FILTer:FRAMe<fr>:FLD<fl>:DMIN..... | 675 |
| SBUS<sb>:I2C:FILTer:FRAMe<fr>:FLD<fl>:DOPerator..... | 675 |
| SBUS<sb>:I2C:FILTer:FRAMe<fr>:FLD<fl>:ENABle..... | 677 |
| SBUS<sb>:I2C:FILTer:FRAMe<fr>:FLD<fl>:IMAX..... | 676 |
| SBUS<sb>:I2C:FILTer:FRAMe<fr>:FLD<fl>:IMIN..... | 676 |
| SBUS<sb>:I2C:FILTer:FRAMe<fr>:FLD<fl>:IOPerator..... | 676 |
| SBUS<sb>:I2C:FILTer:FRENable..... | 674 |
| SBUS<sb>:I2C:FILTer:IMAX..... | 676 |
| SBUS<sb>:I2C:FILTer:IMIN..... | 676 |
| SBUS<sb>:I2C:FILTer:IOPerator..... | 676 |
| SBUS<sb>:I2C:FRAMe<fr>:AACCEss?..... | 678 |
| SBUS<sb>:I2C:FRAMe<fr>:ACCEss?..... | 678 |
| SBUS<sb>:I2C:FRAMe<fr>:ACOMplete?..... | 679 |
| SBUS<sb>:I2C:FRAMe<fr>:ADBStart?..... | 679 |
| SBUS<sb>:I2C:FRAMe<fr>:ADDRess?..... | 679 |
| SBUS<sb>:I2C:FRAMe<fr>:ADEVice?..... | 680 |
| SBUS<sb>:I2C:FRAMe<fr>:AMODE?..... | 680 |
| SBUS<sb>:I2C:FRAMe<fr>:ASTart?..... | 680 |
| SBUS<sb>:I2C:FRAMe<fr>:BCOunt?..... | 681 |
| SBUS<sb>:I2C:FRAMe<fr>:BITRate?..... | 681 |
| SBUS<sb>:I2C:FRAMe<fr>:BYTE<o>:ACCEss?..... | 681 |
| SBUS<sb>:I2C:FRAMe<fr>:BYTE<o>:ACKStart?..... | 682 |
| SBUS<sb>:I2C:FRAMe<fr>:BYTE<o>:COMplete?..... | 682 |
| SBUS<sb>:I2C:FRAMe<fr>:BYTE<o>:START?..... | 682 |
| SBUS<sb>:I2C:FRAMe<fr>:BYTE<o>:VALue?..... | 683 |
| SBUS<sb>:I2C:FRAMe<fr>:DATA?..... | 683 |
| SBUS<sb>:I2C:FRAMe<fr>:RWBStart?..... | 683 |
| SBUS<sb>:I2C:FRAMe<fr>:START?..... | 684 |
| SBUS<sb>:I2C:FRAMe<fr>:STATus?..... | 684 |
| SBUS<sb>:I2C:FRAMe<fr>:STOP?..... | 685 |
| SBUS<sb>:I2C:FRAMe<fr>:SYMBol?..... | 685 |
| SBUS<sb>:I2C:NEWList..... | 669 |
| SBUS<sb>:I2C:SCL:HYSteresis..... | 667 |

| | |
|--|-----|
| SBUS<sb>:I2C:SCL:SOURce..... | 667 |
| SBUS<sb>:I2C:SCL:THReshold..... | 667 |
| SBUS<sb>:I2C:SDA:HYSteresis..... | 668 |
| SBUS<sb>:I2C:SDA:POSition..... | 668 |
| SBUS<sb>:I2C:SDA:SCALe..... | 669 |
| SBUS<sb>:I2C:SDA:SOURce..... | 668 |
| SBUS<sb>:I2C:SDA:THReshold..... | 668 |
| SBUS<sb>:I2C:SYMBols..... | 669 |
| SBUS<sb>:LIN:BITRate..... | 733 |
| SBUS<sb>:LIN:DATA:HYSteresis..... | 734 |
| SBUS<sb>:LIN:DATA:SOURce..... | 734 |
| SBUS<sb>:LIN:DATA:THReshold..... | 734 |
| SBUS<sb>:LIN:FCOunt?..... | 743 |
| SBUS<sb>:LIN:FILTer:BIT..... | 739 |
| SBUS<sb>:LIN:FILTer:DMAX..... | 740 |
| SBUS<sb>:LIN:FILTer:DMIN..... | 740 |
| SBUS<sb>:LIN:FILTer:DOPerator..... | 740 |
| SBUS<sb>:LIN:FILTer:ERENable..... | 741 |
| SBUS<sb>:LIN:FILTer:ERRor<n>:ENABLE..... | 741 |
| SBUS<sb>:LIN:FILTer:FIENable..... | 741 |
| SBUS<sb>:LIN:FILTer:FRAMe<fr>:ENABLE..... | 742 |
| SBUS<sb>:LIN:FILTer:FRAMe<fr>:FLD<fl>:BIT..... | 739 |
| SBUS<sb>:LIN:FILTer:FRAMe<fr>:FLD<fl>:DMAX..... | 740 |
| SBUS<sb>:LIN:FILTer:FRAMe<fr>:FLD<fl>:DMIN..... | 740 |
| SBUS<sb>:LIN:FILTer:FRAMe<fr>:FLD<fl>:DOPerator..... | 740 |
| SBUS<sb>:LIN:FILTer:FRAMe<fr>:FLD<fl>:ENABLE..... | 741 |
| SBUS<sb>:LIN:FILTer:FRAMe<fr>:FLD<fl>:IMAX..... | 742 |
| SBUS<sb>:LIN:FILTer:FRAMe<fr>:FLD<fl>:IMIN..... | 742 |
| SBUS<sb>:LIN:FILTer:FRAMe<fr>:FLD<fl>:IOPerator..... | 743 |
| SBUS<sb>:LIN:FILTer:FRENable..... | 742 |
| SBUS<sb>:LIN:FILTer:IMAX..... | 742 |
| SBUS<sb>:LIN:FILTer:IMIN..... | 742 |
| SBUS<sb>:LIN:FILTer:IOPerator..... | 743 |
| SBUS<sb>:LIN:FRAMe<fr>:BITRate?..... | 744 |
| SBUS<sb>:LIN:FRAMe<fr>:BYTE<o>:COUNT?..... | 745 |
| SBUS<sb>:LIN:FRAMe<fr>:BYTE<o>:FVALue?..... | 745 |
| SBUS<sb>:LIN:FRAMe<fr>:BYTE<o>:LABel?..... | 745 |
| SBUS<sb>:LIN:FRAMe<fr>:BYTE<o>:STATe?..... | 744 |
| SBUS<sb>:LIN:FRAMe<fr>:BYTE<o>:VALue?..... | 744 |
| SBUS<sb>:LIN:FRAMe<fr>:CSValue?..... | 746 |
| SBUS<sb>:LIN:FRAMe<fr>:DATA?..... | 746 |
| SBUS<sb>:LIN:FRAMe<fr>:IDPValue?..... | 746 |
| SBUS<sb>:LIN:FRAMe<fr>:IDState?..... | 747 |
| SBUS<sb>:LIN:FRAMe<fr>:IDValue?..... | 747 |
| SBUS<sb>:LIN:FRAMe<fr>:PIDentifier?..... | 748 |
| SBUS<sb>:LIN:FRAMe<fr>:START?..... | 747 |
| SBUS<sb>:LIN:FRAMe<fr>:STATus?..... | 748 |
| SBUS<sb>:LIN:FRAMe<fr>:STOP?..... | 748 |
| SBUS<sb>:LIN:POLarity..... | 734 |
| SBUS<sb>:LIN:POSition..... | 735 |

| | |
|--|-----|
| SBUS<sb>:LIN:SCALe..... | 735 |
| SBUS<sb>:LIN:STANdard..... | 735 |
| SBUS<sb>:RESult..... | 645 |
| SBUS<sb>:SPI:BORDer..... | 649 |
| SBUS<sb>:SPI:CSElect:HYSTeresis..... | 650 |
| SBUS<sb>:SPI:CSElect:POLarity..... | 650 |
| SBUS<sb>:SPI:CSElect:SOURce..... | 650 |
| SBUS<sb>:SPI:CSElect:THReshold..... | 650 |
| SBUS<sb>:SPI:FCOut?..... | 662 |
| SBUS<sb>:SPI:FILTer:BIT..... | 656 |
| SBUS<sb>:SPI:FILTer:DMAX..... | 656 |
| SBUS<sb>:SPI:FILTer:DMIN..... | 657 |
| SBUS<sb>:SPI:FILTer:DOPerator..... | 657 |
| SBUS<sb>:SPI:FILTer:ENABle..... | 656 |
| SBUS<sb>:SPI:FILTer:ERENable..... | 657 |
| SBUS<sb>:SPI:FILTer:ERRor<n>:ENABle..... | 657 |
| SBUS<sb>:SPI:FILTer:FIENable..... | 658 |
| SBUS<sb>:SPI:FILTer:FRAMe<fr>:ENABle..... | 658 |
| SBUS<sb>:SPI:FILTer:FRAMe<fr>:FLD<fl>:BIT..... | 656 |
| SBUS<sb>:SPI:FILTer:FRAMe<fr>:FLD<fl>:DMAX..... | 656 |
| SBUS<sb>:SPI:FILTer:FRAMe<fr>:FLD<fl>:DMIN..... | 657 |
| SBUS<sb>:SPI:FILTer:FRAMe<fr>:FLD<fl>:DOPerator..... | 657 |
| SBUS<sb>:SPI:FILTer:FRAMe<fr>:FLD<fl>:ENABle..... | 658 |
| SBUS<sb>:SPI:FILTer:FRAMe<fr>:FLD<fl>:IMAX..... | 658 |
| SBUS<sb>:SPI:FILTer:FRAMe<fr>:FLD<fl>:IMIN..... | 659 |
| SBUS<sb>:SPI:FILTer:FRAMe<fr>:FLD<fl>:IOPerator..... | 659 |
| SBUS<sb>:SPI:FILTer:FRENable..... | 658 |
| SBUS<sb>:SPI:FILTer:IMAX..... | 658 |
| SBUS<sb>:SPI:FILTer:IMIN..... | 659 |
| SBUS<sb>:SPI:FILTer:IOPerator..... | 659 |
| SBUS<sb>:SPI:FRAMe<fr>:BITRate?..... | 662 |
| SBUS<sb>:SPI:FRAMe<fr>:COUNt?..... | 662 |
| SBUS<sb>:SPI:FRAMe<fr>:DATA?..... | 662 |
| SBUS<sb>:SPI:FRAMe<fr>:STARt?..... | 663 |
| SBUS<sb>:SPI:FRAMe<fr>:STATus?..... | 663 |
| SBUS<sb>:SPI:FRAMe<fr>:STOP?..... | 664 |
| SBUS<sb>:SPI:FRAMe<fr>:WCOut?..... | 664 |
| SBUS<sb>:SPI:FRAMe<fr>:WORD<w>:FMISo?..... | 664 |
| SBUS<sb>:SPI:FRAMe<fr>:WORD<w>:FMOSi?..... | 664 |
| SBUS<sb>:SPI:FRAMe<fr>:WORD<w>:MISO?..... | 665 |
| SBUS<sb>:SPI:FRAMe<fr>:WORD<w>:MOSI?..... | 665 |
| SBUS<sb>:SPI:FRAMe<fr>:WORD<w>:STARt?..... | 665 |
| SBUS<sb>:SPI:FRAMe<fr>:WORD<w>:STOP?..... | 666 |
| SBUS<sb>:SPI:FRCondition..... | 649 |
| SBUS<sb>:SPI:MISO:HYSTeresis..... | 651 |
| SBUS<sb>:SPI:MISO:POLarity..... | 651 |
| SBUS<sb>:SPI:MISO:POSition..... | 654 |
| SBUS<sb>:SPI:MISO:SCALe..... | 655 |
| SBUS<sb>:SPI:MISO:SOURce..... | 651 |
| SBUS<sb>:SPI:MISO:THReshold..... | 652 |

| | |
|---|-----|
| SBUS<sb>:SPI:MOSI:HYSteresis..... | 652 |
| SBUS<sb>:SPI:MOSI:POLarity..... | 652 |
| SBUS<sb>:SPI:MOSI:POSition..... | 655 |
| SBUS<sb>:SPI:MOSI:SCALe..... | 655 |
| SBUS<sb>:SPI:MOSI:SOURce..... | 652 |
| SBUS<sb>:SPI:MOSI:THReshold..... | 653 |
| SBUS<sb>:SPI:SCLK:HYSteresis..... | 653 |
| SBUS<sb>:SPI:SCLK:SOURce..... | 653 |
| SBUS<sb>:SPI:SCLK:THReshold..... | 654 |
| SBUS<sb>:SPI:TIMEout..... | 654 |
| SBUS<sb>:SPI:WSIZe..... | 654 |
| SBUS<sb>:TYPE..... | 645 |
| SBUS<sb>:UART:BITRate..... | 686 |
| SBUS<sb>:UART:BORDER..... | 686 |
| SBUS<sb>:UART:FILTer:BIT..... | 696 |
| SBUS<sb>:UART:FILTer:DMAX..... | 696 |
| SBUS<sb>:UART:FILTer:DMIN..... | 696 |
| SBUS<sb>:UART:FILTer:DOPERator..... | 695 |
| SBUS<sb>:UART:FILTer:ERENable..... | 695 |
| SBUS<sb>:UART:FILTer:ERRor<n>:ENABLE..... | 695 |
| SBUS<sb>:UART:FILTer:FIENable..... | 697 |
| SBUS<sb>:UART:FILTer:FRAMe<fr>:ENABLE..... | 697 |
| SBUS<sb>:UART:FILTer:FRAMe<fr>:FLD<fl>:BIT..... | 696 |
| SBUS<sb>:UART:FILTer:FRAMe<fr>:FLD<fl>:DMAX..... | 696 |
| SBUS<sb>:UART:FILTer:FRAMe<fr>:FLD<fl>:DMIN..... | 696 |
| SBUS<sb>:UART:FILTer:FRAMe<fr>:FLD<fl>:DOPERator..... | 695 |
| SBUS<sb>:UART:FILTer:FRAMe<fr>:FLD<fl>:ENABLE..... | 697 |
| SBUS<sb>:UART:FILTer:FRAMe<fr>:FLD<fl>:IMAX..... | 694 |
| SBUS<sb>:UART:FILTer:FRAMe<fr>:FLD<fl>:IMIN..... | 694 |
| SBUS<sb>:UART:FILTer:FRAMe<fr>:FLD<fl>:IOPERator..... | 695 |
| SBUS<sb>:UART:FILTer:FRENable..... | 697 |
| SBUS<sb>:UART:FILTer:IMAX..... | 694 |
| SBUS<sb>:UART:FILTer:IMIN..... | 694 |
| SBUS<sb>:UART:FILTer:IOPERator..... | 695 |
| SBUS<sb>:UART:PACKets..... | 687 |
| SBUS<sb>:UART:PARity..... | 687 |
| SBUS<sb>:UART:POLarity..... | 688 |
| SBUS<sb>:UART:RX:HYSteresis..... | 688 |
| SBUS<sb>:UART:RX:POSition..... | 691 |
| SBUS<sb>:UART:RX:SCALe..... | 691 |
| SBUS<sb>:UART:RX:SOURce..... | 688 |
| SBUS<sb>:UART:RX:THReshold..... | 689 |
| SBUS<sb>:UART:SBIT..... | 689 |
| SBUS<sb>:UART:SSIZe..... | 689 |
| SBUS<sb>:UART:TOUT..... | 690 |
| SBUS<sb>:UART:TX:HYSteresis..... | 690 |
| SBUS<sb>:UART:TX:POSition..... | 691 |
| SBUS<sb>:UART:TX:SCALe..... | 691 |
| SBUS<sb>:UART:TX:SOURce..... | 690 |
| SBUS<sb>:UART:TX:THReshold..... | 690 |

| | |
|--|-----|
| SBUS<sb>:UART:WORD<w>:BITRate? | 698 |
| SBUS<sb>:UART:WORD<w>:COUNT? | 698 |
| SBUS<sb>:UART:WORD<w>:RXValue? | 698 |
| SBUS<sb>:UART:WORD<w>:SOURCE? | 699 |
| SBUS<sb>:UART:WORD<w>:START? | 699 |
| SBUS<sb>:UART:WORD<w>:STATE? | 700 |
| SBUS<sb>:UART:WORD<w>:STOP? | 699 |
| SBUS<sb>:UART:WORD<w>:TXValue? | 700 |
| SBUS<sb>[:STATE]..... | 645 |
| SENSe[:ROSCillator]:OUTPut[:ENABle]..... | 491 |
| SENSe[:ROSCillator]:SOURCE..... | 492 |
| SERVice:REPort..... | 459 |
| SINGLE..... | 460 |
| STATus:OPERation:CONDition? | 781 |
| STATus:OPERation:ENABle..... | 782 |
| STATus:OPERation[:EVENT]? | 781 |
| STATus:PRESet..... | 781 |
| STATus:QUEStionable:ADCState:CONDition? | 784 |
| STATus:QUEStionable:ADCState:ENABle..... | 786 |
| STATus:QUEStionable:ADCState:NTRansition..... | 786 |
| STATus:QUEStionable:ADCState:PTRansition..... | 787 |
| STATus:QUEStionable:ADCState[:EVENT]? | 785 |
| STATus:QUEStionable:COVerload:CONDition? | 784 |
| STATus:QUEStionable:COVerload:ENABle..... | 786 |
| STATus:QUEStionable:COVerload:NTRansition..... | 786 |
| STATus:QUEStionable:COVerload:PTRansition..... | 787 |
| STATus:QUEStionable:COVerload[:EVENT]? | 785 |
| STATus:QUEStionable:GOVerload:CONDition? | 784 |
| STATus:QUEStionable:GOVerload:ENABle..... | 786 |
| STATus:QUEStionable:GOVerload:NTRansition..... | 786 |
| STATus:QUEStionable:GOVerload:PTRansition..... | 787 |
| STATus:QUEStionable:GOVerload[:EVENT]? | 785 |
| STATus:QUEStionable:IMPRecise:CONDition? | 784 |
| STATus:QUEStionable:IMPRecise:ENABle..... | 786 |
| STATus:QUEStionable:IMPRecise:NTRansition..... | 786 |
| STATus:QUEStionable:IMPRecise:PTRansition..... | 787 |
| STATus:QUEStionable:IMPRecise[:EVENT]? | 785 |
| STATus:QUEStionable:LIMit:CONDition? | 784 |
| STATus:QUEStionable:LIMit:ENABle..... | 786 |
| STATus:QUEStionable:LIMit:NTRansition..... | 786 |
| STATus:QUEStionable:LIMit:PTRansition..... | 787 |
| STATus:QUEStionable:LIMit[:EVENT]? | 785 |
| STATus:QUEStionable:MARGin:CONDition? | 784 |
| STATus:QUEStionable:MARGin:ENABle..... | 786 |
| STATus:QUEStionable:MARGin:NTRansition..... | 786 |
| STATus:QUEStionable:MARGin:PTRansition..... | 787 |
| STATus:QUEStionable:MARGin[:EVENT]? | 785 |
| STATus:QUEStionable:PLL:CONDition? | 784 |
| STATus:QUEStionable:PLL:ENABle..... | 786 |
| STATus:QUEStionable:PLL:NTRansition..... | 786 |

| | |
|--|-----|
| STATus:QUEStionable:PLL:PTRansition..... | 787 |
| STATus:QUEStionable:PLL[:EVENT]?..... | 785 |
| STATus:QUEStionable:PPSupply:CONDition?..... | 784 |
| STATus:QUEStionable:PPSupply:ENABle..... | 786 |
| STATus:QUEStionable:PPSupply:NTRansition..... | 786 |
| STATus:QUEStionable:PPSupply:PTRansition..... | 787 |
| STATus:QUEStionable:PPSupply[:EVENT]?..... | 785 |
| STATus:QUEStionable:TEMPerature:CONDition?..... | 784 |
| STATus:QUEStionable:TEMPerature:ENABle..... | 786 |
| STATus:QUEStionable:TEMPerature:NTRansition..... | 786 |
| STATus:QUEStionable:TEMPerature:PTRansition..... | 787 |
| STATus:QUEStionable:TEMPerature[:EVENT]?..... | 785 |
| STOP..... | 461 |
| SYSTem:APUP..... | 460 |
| SYSTem:COMMunicate:NET[:HOSTname]..... | 441 |
| SYSTem:DATE..... | 441 |
| SYSTem:DISPlay:MESSage:STATe..... | 440 |
| SYSTem:DISPlay:MESSage[:TEXT]..... | 441 |
| SYSTem:DISPlay:UPDate..... | 440 |
| SYSTem:EXIT..... | 442 |
| SYSTem:FW:FILEpath..... | 442 |
| SYSTem:FW:START..... | 443 |
| SYSTem:PRESet..... | 442 |
| SYSTem:SHUTdown..... | 442 |
| SYSTem:TIME..... | 443 |
| TIMEbase:DIVisions?..... | 462 |
| TIMEbase:HORIZontal:POSition..... | 462 |
| TIMEbase:RANGE..... | 461 |
| TIMEbase:REFerence..... | 462 |
| TIMEbase:ROLL:ENABle..... | 463 |
| TIMEbase:ROLL:MTIME..... | 463 |
| TIMEbase:ROLL:STATe?..... | 464 |
| TIMEbase:SCALE..... | 461 |
| TRIGger:ACTions:OUT:DELay..... | 517 |
| TRIGger:ACTions:OUT:OVERload:STATus:CONDition?..... | 784 |
| TRIGger:ACTions:OUT:OVERload:STATus:ENABle..... | 785 |
| TRIGger:ACTions:OUT:OVERload:STATus:NTRansition..... | 786 |
| TRIGger:ACTions:OUT:OVERload:STATus:PTRansition..... | 786 |
| TRIGger:ACTions:OUT:OVERload:STATus:PTRansition..... | 787 |
| TRIGger:ACTions:OUT:OVERload:STATus[:EVENT]..... | 785 |
| TRIGger:ACTions:OUT:PLENght..... | 517 |
| TRIGger:ACTions:OUT:POLarity..... | 517 |
| TRIGger:ACTions:OUT:SOURce..... | 517 |
| TRIGger:ACTions:OUT:STATe..... | 516 |
| TRIGger:ANEDge:COUPling..... | 495 |
| TRIGger:ANEDge:CUToff:HIGHPass..... | 496 |
| TRIGger:ANEDge:CUToff:LOWPass..... | 496 |
| TRIGger:ANEDge:FILTer..... | 495 |
| TRIGger:ANEDge:LEVel..... | 495 |
| TRIGger:ANEDge:NREJect..... | 496 |

| | |
|--|-----|
| TRIGger:ANEDge:OVERload:STATus:CONDition? | 784 |
| TRIGger:ANEDge:OVERload:STATus:ENABle | 786 |
| TRIGger:ANEDge:OVERload:STATus:PTRansition | 787 |
| TRIGger:ANEDge:OVERload:STATus[:EVENT] | 785 |
| TRIGger:CAN:ACKerror | 711 |
| TRIGger:CAN:BITSterror | 711 |
| TRIGger:CAN:CRCError | 711 |
| TRIGger:CAN:DCONDition | 707 |
| TRIGger:CAN:DLC | 708 |
| TRIGger:CAN:DLCCondition | 708 |
| TRIGger:CAN:DMIN | 708 |
| TRIGger:CAN:FDATa:BRS | 712 |
| TRIGger:CAN:FDATa:DPOSITion | 708 |
| TRIGger:CAN:FDATa:ESI | 712 |
| TRIGger:CAN:FDATa:SCERror | 710 |
| TRIGger:CAN:FORMerror | 710 |
| TRIGger:CAN:FTYPE | 709 |
| TRIGger:CAN:ICONDition | 709 |
| TRIGger:CAN:IMAX | 709 |
| TRIGger:CAN:IMIN | 710 |
| TRIGger:CAN:ITYPe | 710 |
| TRIGger:CAN:TYPE | 707 |
| TRIGger:CAN:XDATa:AF:CONDition | 712 |
| TRIGger:CAN:XDATa:AF:MAX | 713 |
| TRIGger:CAN:XDATa:AF:MIN | 713 |
| TRIGger:CAN:XDATa:SDT:CONDition | 713 |
| TRIGger:CAN:XDATa:SDT:MAX | 713 |
| TRIGger:CAN:XDATa:SDT:MIN | 714 |
| TRIGger:CAN:XDATa:SEC | 714 |
| TRIGger:CAN:XDATa:VCID:CONDition | 714 |
| TRIGger:CAN:XDATa:VCID:MAX | 715 |
| TRIGger:CAN:XDATa:VCID:MIN | 715 |
| TRIGger:EVENT<ev>:EDGE:SLOPe | 494 |
| TRIGger:EVENT<ev>:GLITCh:POLarity | 497 |
| TRIGger:EVENT<ev>:GLITCh:RANGe | 497 |
| TRIGger:EVENT<ev>:GLITCh:WIDTh | 497 |
| TRIGger:EVENT<ev>:INTerval:DELTA | 506 |
| TRIGger:EVENT<ev>:INTerval:RANGe | 506 |
| TRIGger:EVENT<ev>:INTerval:SLOPe | 507 |
| TRIGger:EVENT<ev>:INTerval:WIDTh | 507 |
| TRIGger:EVENT<ev>:LEVel<n>:RUNT:LOWer | 499 |
| TRIGger:EVENT<ev>:LEVel<n>:RUNT:UPPer | 500 |
| TRIGger:EVENT<ev>:LEVel<n>:SLEW:LOWer | 507 |
| TRIGger:EVENT<ev>:LEVel<n>:SLEW:UPPer | 508 |
| TRIGger:EVENT<ev>:LEVel<n>:WINDow:LOWer | 502 |
| TRIGger:EVENT<ev>:LEVel<n>:WINDow:UPPer | 502 |
| TRIGger:EVENT<ev>:LEVel<n>[:VALue] | 493 |
| TRIGger:EVENT<ev>:RUNT:DELTA | 500 |
| TRIGger:EVENT<ev>:RUNT:POLarity | 500 |
| TRIGger:EVENT<ev>:RUNT:RANGe | 501 |

| | |
|---------------------------------------|-----|
| TRIGger:EVENT<ev>:RUNT:WIDTh..... | 501 |
| TRIGger:EVENT<ev>:SLEW:DELTA..... | 508 |
| TRIGger:EVENT<ev>:SLEW:RANGe..... | 508 |
| TRIGger:EVENT<ev>:SLEW:RATE..... | 509 |
| TRIGger:EVENT<ev>:SLEW:SLOPe..... | 509 |
| TRIGger:EVENT<ev>:SOURce..... | 494 |
| TRIGger:EVENT<ev>:TIMEout:RANGe..... | 505 |
| TRIGger:EVENT<ev>:TIMEout:TIME..... | 505 |
| TRIGger:EVENT<ev>:TYPE..... | 493 |
| TRIGger:EVENT<ev>:WIDTh:DELTA..... | 498 |
| TRIGger:EVENT<ev>:WIDTh:POLarity..... | 498 |
| TRIGger:EVENT<ev>:WIDTh:RANGe..... | 498 |
| TRIGger:EVENT<ev>:WIDTh:WIDTh..... | 499 |
| TRIGger:EVENT<ev>:WINDow:DELTA..... | 503 |
| TRIGger:EVENT<ev>:WINDow:RANGe..... | 503 |
| TRIGger:EVENT<ev>:WINDow:TIME..... | 504 |
| TRIGger:EVENT<ev>:WINDow:WIDTh..... | 504 |
| TRIGger:FILTermode..... | 515 |
| TRIGger:FINDlevel..... | 494 |
| TRIGger:FORCe..... | 510 |
| TRIGger:HOLDoff:AUTotime?..... | 511 |
| TRIGger:HOLDoff:EVENTs..... | 512 |
| TRIGger:HOLDoff:MAX..... | 512 |
| TRIGger:HOLDoff:MIN..... | 513 |
| TRIGger:HOLDoff:MODE..... | 511 |
| TRIGger:HOLDoff:SCALing..... | 512 |
| TRIGger:HOLDoff:TIME..... | 513 |
| TRIGger:I2C:ACCess..... | 670 |
| TRIGger:I2C:ACONdition..... | 671 |
| TRIGger:I2C:ADDRess..... | 671 |
| TRIGger:I2C:ADDTo..... | 671 |
| TRIGger:I2C:ADNack..... | 671 |
| TRIGger:I2C:AMODE..... | 672 |
| TRIGger:I2C:DCONdition..... | 672 |
| TRIGger:I2C:DMIN..... | 672 |
| TRIGger:I2C:DPOSITION..... | 672 |
| TRIGger:I2C:DRNack..... | 672 |
| TRIGger:I2C:DWNack..... | 673 |
| TRIGger:I2C:TYPE..... | 670 |
| TRIGger:LFRject..... | 516 |
| TRIGger:LIN:CHKSError..... | 736 |
| TRIGger:LIN:DCONdition..... | 737 |
| TRIGger:LIN:DMIN..... | 737 |
| TRIGger:LIN:DPOSITION..... | 737 |
| TRIGger:LIN:ICONdition..... | 737 |
| TRIGger:LIN:IMAX..... | 738 |
| TRIGger:LIN:IMIN..... | 738 |
| TRIGger:LIN:IPERror..... | 738 |
| TRIGger:LIN:SYERror..... | 738 |
| TRIGger:LIN:TYPE..... | 736 |

| | |
|--|-----|
| TRIGger:MEVents:MODE..... | 493 |
| TRIGger:MODE..... | 510 |
| TRIGger:NOISe<m>:ABSolute..... | 513 |
| TRIGger:NOISe<m>:EFFective?..... | 514 |
| TRIGger:NOISe<m>:MODE..... | 514 |
| TRIGger:NOISe<m>:PERDivision..... | 514 |
| TRIGger:NOISe<m>:RELative..... | 515 |
| TRIGger:NOISe<m>[:STATe]..... | 515 |
| TRIGger:RFReject..... | 516 |
| TRIGger:SPI:DMINpattern..... | 660 |
| TRIGger:SPI:DPOSITION..... | 660 |
| TRIGger:SPI:FCONdition..... | 661 |
| TRIGger:SPI:PALignment..... | 661 |
| TRIGger:SPI:TYPE..... | 660 |
| TRIGger:UART:DATA..... | 692 |
| TRIGger:UART:DPOSITION..... | 692 |
| TRIGger:UART:FCONdition..... | 692 |
| TRIGger:UART:OPERator..... | 693 |
| TRIGger:UART:SOURce..... | 693 |
| TRIGger:UART:TYPE..... | 693 |
| WGENerator<wg>:ARBGen:NAME..... | 775 |
| WGENerator<wg>:ARBGen:OPEN..... | 775 |
| WGENerator<wg>:ARBGen:RUNMode..... | 776 |
| WGENerator<wg>:ARBGen:RUNSingle..... | 776 |
| WGENerator<wg>:ARBGen:SAMPles?..... | 776 |
| WGENerator<wg>:ARBGen:SRATe..... | 777 |
| WGENerator<wg>:ARBGen[:SOURce]..... | 777 |
| WGENerator<wg>:COUPling:AMPLitude..... | 779 |
| WGENerator<wg>:COUPling:PHASeshift..... | 780 |
| WGENerator<wg>:COUPling:STATe..... | 779 |
| WGENerator<wg>:COUPling[:FREQuency]..... | 780 |
| WGENerator<wg>:FREQuency..... | 762 |
| WGENerator<wg>:FUNCTion:PULSe[:WIDTh]..... | 762 |
| WGENerator<wg>:FUNCTion:RAMP[:SYMMetry]..... | 763 |
| WGENerator<wg>:FUNCTion[:SElect]..... | 763 |
| WGENerator<wg>:FUNCTion[:SQUare]:DCYCLE..... | 763 |
| WGENerator<wg>:GOVerload:STATus:CONDition?..... | 784 |
| WGENerator<wg>:GOVerload:STATus:ENABLE..... | 786 |
| WGENerator<wg>:GOVerload:STATus:NTRansition..... | 786 |
| WGENerator<wg>:GOVerload:STATus:PTRansition..... | 787 |
| WGENerator<wg>:GOVerload:STATus[:EVENT]..... | 785 |
| WGENerator<wg>:MODulation:AM:DCYCLE..... | 767 |
| WGENerator<wg>:MODulation:AM:DEPTH..... | 768 |
| WGENerator<wg>:MODulation:AM:FREQuency..... | 768 |
| WGENerator<wg>:MODulation:AM:SYMMetry..... | 768 |
| WGENerator<wg>:MODulation:AM[:FUNCTion]..... | 769 |
| WGENerator<wg>:MODulation:CARRier:FREQuency..... | 769 |
| WGENerator<wg>:MODulation:CARRier:PERiod..... | 769 |
| WGENerator<wg>:MODulation:FM:DCYCLE..... | 770 |
| WGENerator<wg>:MODulation:FM:DEVIation..... | 770 |

| | |
|--|-----|
| WGENerator<wg>:MODulation:FM:FREQuency..... | 770 |
| WGENerator<wg>:MODulation:FM:SYMMetry..... | 771 |
| WGENerator<wg>:MODulation:FM[:FUNction]..... | 771 |
| WGENerator<wg>:MODulation:FSK:FONE..... | 771 |
| WGENerator<wg>:MODulation:FSK:FTWO..... | 771 |
| WGENerator<wg>:MODulation:FSK[:RATE]..... | 772 |
| WGENerator<wg>:MODulation:NDCLevel..... | 772 |
| WGENerator<wg>:MODulation:NLABSolute?..... | 772 |
| WGENerator<wg>:MODulation:NLPCent..... | 773 |
| WGENerator<wg>:MODulation:PWM:DCYCLE..... | 773 |
| WGENerator<wg>:MODulation:PWM:DEPTh..... | 773 |
| WGENerator<wg>:MODulation:PWM:FREQuency..... | 774 |
| WGENerator<wg>:MODulation:PWM:SYMMetry..... | 774 |
| WGENerator<wg>:MODulation:PWM[:FUNction]..... | 774 |
| WGENerator<wg>:MODulation:TYPE..... | 775 |
| WGENerator<wg>:MODulation[:STATe]..... | 767 |
| WGENerator<wg>:OUTPut[:LOAD]..... | 764 |
| WGENerator<wg>:PERiod..... | 764 |
| WGENerator<wg>:PRESet..... | 764 |
| WGENerator<wg>:SWEep:FEND..... | 778 |
| WGENerator<wg>:SWEep:FSTart..... | 778 |
| WGENerator<wg>:SWEep:TIME..... | 778 |
| WGENerator<wg>:SWEep:TYPE..... | 778 |
| WGENerator<wg>:SWEep[:STATe]..... | 777 |
| WGENerator<wg>:TEMPerature:STATus:CONDition?..... | 784 |
| WGENerator<wg>:TEMPerature:STATus:ENABle..... | 786 |
| WGENerator<wg>:TEMPerature:STATus:NTRansition..... | 786 |
| WGENerator<wg>:TEMPerature:STATus:PTRansition..... | 787 |
| WGENerator<wg>:TEMPerature:STATus[:EVENT]..... | 785 |
| WGENerator<wg>:VOLTage:DCLevel..... | 765 |
| WGENerator<wg>:VOLTage:HIGH..... | 765 |
| WGENerator<wg>:VOLTage:INVersion..... | 765 |
| WGENerator<wg>:VOLTage:LOW..... | 765 |
| WGENerator<wg>:VOLTage:OFFSet..... | 766 |
| WGENerator<wg>:VOLTage[:VPP]..... | 766 |
| WGENerator<wg>[:ENABle]..... | 766 |

Index

A

| | |
|--------------------------------|---------|
| Acquisition | |
| Single, multiple | 36, 107 |
| Start and stop | 36, 107 |
| Acquisitions per second | 112 |
| Active waveform | 53 |
| Aligning | |
| Input channels | 93 |
| Annotate | 58, 63 |
| Apps key | 42 |
| Arranging waveforms | 54 |
| Auto Norm | |
| Key | 36 |
| Auto trigger mode | 36 |
| Auto, trigger mode | 153 |
| Autonaming | 95 |
| Autoset | |
| Key | 41 |
| Average | |
| Spectrum | 224 |
| Average count | 108 |
| Average count (N-single count) | 108 |

B

| | |
|------------------------------|-----|
| Bench top operation | 25 |
| Bit pattern editor | 292 |
| Blackman Harris window (FFT) | 224 |
| Blind time | 112 |
| Bug report | 792 |
| Bus key | 39 |

C

| | |
|------------------------------|-----|
| Camera key | 41 |
| CAN | |
| Configuring | 360 |
| Decode results | 358 |
| Trigger settings | 349 |
| Triggering | 361 |
| Changing fuses | 791 |
| Channel | |
| Waveforms | 52 |
| Clear status | |
| Remote | 436 |
| Clock | |
| Logic | 382 |
| Command sequence | |
| Remote | 438 |
| Commands | |
| Finding a command | 429 |
| Compensation, passive probes | 132 |
| CONDition | 420 |
| CSV export | 98 |
| Cursor key | 41 |
| Cursor measurements | |
| Envelope waveform | 189 |
| How to | 185 |
| Peak search | 191 |
| Results | 184 |

| | |
|-------------------------|-----|
| Cursors | 58 |
| Configuring display | 186 |
| Configuring measurement | 185 |
| Position | 189 |
| Start measurement | 185 |
| Customer support | 791 |

D

| | |
|-------------------|-----|
| Data entry | 60 |
| Data security | 792 |
| Date/time display | 65 |
| Decode table | |
| MSO | 385 |
| Default | |
| File names | 97 |
| Path for saving | 97 |
| Default values | |
| Remote | 437 |
| Delete | 59 |
| Demo | |
| Input connectors | 32 |
| Device ID | 70 |
| Device name | 409 |
| DHCP | 408 |
| DHCP server | |
| LAN configuration | 409 |
| Diagrams | 47 |
| Dialog boxes | |
| Usage | 59 |
| Dialogs | 49 |
| Digital channels | |
| Decode table | 385 |
| Display | |
| Intensity | 86 |
| Overview | 46 |
| Display elements | 46 |
| Diagram | 46 |
| DisplayPort | 33 |
| DNS server | |
| LAN configuration | 409 |
| Download data | 413 |

E

| | |
|------------------------------------|-----|
| Edge trigger | 138 |
| Edit spectrum | 59 |
| ENABle | 420 |
| Envelope | |
| Measurements | 208 |
| Envelope waveform | |
| Cursor measurement | 189 |
| Error queue | 422 |
| Error report | 792 |
| ESE (Event Status Enable register) | 422 |
| ESR | 419 |
| ESR (Event Status Register) | 422 |
| EVENT | 420 |
| Event Status Enable register (ESE) | 422 |
| Event Status Register (ESR) | 422 |
| External monitor | 33 |

F

| | |
|----------------------------|---------|
| FFT | |
| Configuring | 220 |
| Key | 40 |
| Performance considerations | 221 |
| Setup | 222 |
| Window types | 224 |
| File browser | 59, 283 |
| File manager | 413 |
| File names | |
| Default | 95, 97 |
| Files | 283 |
| Firmware version | 70 |
| Flattop2 window (FFT) | 224 |
| Function generator | |
| Output connectors | 35 |
| Fuses | 791 |

G

| | |
|--------------------------|-----|
| Gaussian window (FFT) | 224 |
| Gen key | 39 |
| Glitch trigger | 140 |
| GPIB | |
| Remote control interface | 415 |
| Grid | 47 |
| Grounding | 27 |

H

| | |
|----------------------|-----|
| Hamming window (FFT) | 224 |
| Hann window (FFT) | 224 |
| HD key | 41 |
| HDMI connector | 33 |
| Help | 57 |
| Open | 67 |
| High definition | 111 |
| History | |
| MSO | 384 |
| Time stamp | 173 |
| History key | 41 |
| Holdoff | 152 |
| Horizontal | |
| Label | 48 |
| Position | 37 |
| Host name | 409 |

I

| | |
|---------------------------|-----|
| I2C | |
| Configuring | 322 |
| Triggering | 324 |
| I ² C | |
| Basics | 309 |
| Decode results | 320 |
| Trigger settings | 316 |
| Identification | |
| Remote | 436 |
| Infinite persistence | 85 |
| Info | 48 |
| Information on instrument | 65 |
| Instrument settings | |
| Recall | 437 |
| Save | 438 |
| Intensity | 86 |
| Intensity key | 41 |

| | |
|------------------|-----|
| Interfaces | |
| LAN | 416 |
| Interpolation | 109 |
| Interrupt | 425 |
| Interval trigger | 148 |
| IP address | 416 |
| Changing | 408 |

K

| | |
|----------------------------|-----|
| Kaiser Bessel window (FFT) | 224 |
| Keep X-grid fixed | 82 |
| Keep Y-grid fixed | 82 |
| Keyboard | |
| On-screen | 60 |
| Keypad | 60 |

L

| | |
|--------------------------|----------|
| LAN | |
| Configuration | 407, 410 |
| Connector | 33 |
| Environment | 407 |
| Interface | 416 |
| IP address | 416 |
| Remote control interface | 415 |
| Resource string | 416 |
| Languages | 74 |
| Layout | 47 |
| LIN | |
| Configuring | 375 |
| Decode results | 373 |
| Triggering | 376 |
| Load instrument settings | 437 |
| Lock touchscreen | 41 |
| Logic | |
| Clock setup | 382 |
| Configuration settings | 378 |
| Logic analyzer | 378 |
| Logic buses | |
| Decode table | 385 |
| Logic key | 39 |
| Logical thresholds | |
| MSO, settings | 380 |

M

| | |
|---------------------|--------|
| Material number | 70 |
| Math key | 40 |
| Math waveforms | 40, 52 |
| Displaying | 165 |
| FFT setup | 222 |
| Operators | 167 |
| Measure key | 41 |
| Measurement | 59 |
| Add | 194 |
| Menu | 49, 50 |
| Minimized waveform | 53 |
| Mixed signal option | 378 |
| Monitor | 33 |
| MSO | 378 |
| History | 384 |
| Zoom | 384 |

N

| | |
|----------------------|-----|
| Network | |
| Environment | 407 |
| Normal trigger mode | 36 |
| Normal, trigger mode | 153 |
| Notifications | 65 |
| NTRansition | 420 |
| Numeric data entry | 60 |

O

| | |
|----------------------------|-----|
| On/Off key | 35 |
| Open Source Acknowledgment | 70 |
| Operation | |
| Concepts | 45 |
| Manual | 45 |
| Operation complete | |
| Remote | 437 |
| Operator | |
| Type | 167 |
| Options | |
| Identification (remote) | 437 |
| Output buffer | 419 |

P

| | |
|-----------------------------------|----------|
| Peak excursion | |
| Spectrum measurement | 192, 229 |
| Peak search | |
| Spectrum measurement | 191 |
| Performance | |
| Considerations for FFT | 221 |
| Ping | 412 |
| Position | |
| Horizontal | 37 |
| Power | |
| Connector | 35 |
| On/Off | 27 |
| Power analysis | 246 |
| Power analysis measurement | |
| Add | 246 |
| Preset | 88 |
| Preset key | 41 |
| Printing | |
| Settings | 281 |
| Probes | |
| Compensation connectors | 32 |
| Passive, compensation | 132 |
| Protocols | |
| Advanced settings | 288 |
| CAN decode results | 358 |
| CAN trigger settings | 349 |
| Display settings | 288 |
| Filter settings | 289 |
| I ² C decode results | 320 |
| I ² C trigger settings | 316 |
| LIN decode results | 373 |
| SPI configuration settings | 294 |
| SPI trigger settings | 301 |
| Trigger settings | 289 |
| UART decode results | 335 |
| PTRansition | 420 |

R

| | |
|---------------|----|
| Rack mounting | 26 |
|---------------|----|

| | |
|----------------------------|---------|
| Recall instrument settings | 437 |
| Recall intermediate | 437 |
| Rectangular window (FFT) | 224 |
| Redo | 57 |
| Ref key | 40 |
| Reference waveforms | 40, 52 |
| Displaying | 176 |
| Loading | 176 |
| Saving | 176 |
| Registers | 419 |
| Remote commands | |
| Finding a command | 429 |
| Remote control | 45 |
| Find command using help | 67 |
| Interfaces | 415 |
| Protocols | 415 |
| Starting | 417 |
| Remote Desktop | 45 |
| Remote operation | 45, 413 |
| Repetitive, trigger mode | 153 |
| Reset values | |
| Remote | 437 |
| Resolution | |
| 16 bit | 111 |
| Resource string | |
| LAN | 416 |
| Restoring | |
| Settings | 91 |
| Result tables | 49 |
| Results | |
| Configuring display | 62 |
| Displaying | 62 |
| Roll mode | 102 |
| RS232 | |
| Basics | 326 |
| Run / Stop | 58 |
| Run / Stop key | 36 |
| Runt trigger | 143 |

S

| | |
|---------------------------------------|---------------|
| Save instrument settings | 438 |
| Save intermediate | 438 |
| Save/Recall | |
| Remote | 543 |
| Saving | |
| File name generation | 95 |
| Preset | 88 |
| Screenshots | 283 |
| Scale | |
| Horizontal, rotary knob | 37 |
| SCPI | |
| Finding a command | 429 |
| Screenshot | |
| Saving | 283 |
| Screenshots | 280, 281 |
| Meta information | 280 |
| Search | 50 |
| Secured environment | 792 |
| Select | |
| Waveform | 53 |
| Selected waveform | 53 |
| Self-alignment | 93, 436 |
| Serial number | 70 |
| Service request (SRQ) | 421, 422, 425 |
| Service request enable register (SRE) | 421 |
| Remote | 438 |

- Signal bar 48
- Signal icons 48
- Signal label 48
- Signal view 48
- Single 58
- Single key 36
- Slew rate trigger 150
- Slope key 36
- SmartGrid 54
- Source key 36
- Spectrum measurements
 - Peak excursion 192, 229
- SPI
 - Configuration settings 294
 - Configuring 305
 - Trigger settings 301
 - Triggering 307
- SPI protocol
 - Basics 293
- SRE 419
- SRE (service request enable register) 421
- SRQ (service request) 421, 425
- Status byte
 - Remote 436, 438
- Status byte (STB) 422
- Status registers
 - CONDition 420
 - ENABLE 420
 - EVENT 420
 - NTRansition 420
 - Overview 418
 - PTRansition 420
 - STATus:OPERation 423
- Status reporting system
 - Common commands 435
- Status reports 418
- STB 419
- Style (waveforms) 86
- Switch off
 - Waveform 54
- Switch on
 - Waveform 53
- T**
- Technical support 792
- Temperature
 - Changes 93
- Text entry 60
- Thresholds
 - MSO, settings 380
- Time base 37
- Time scale 37
- Time stamp 173
- Timeout trigger 147
- Toolbar 56
 - Cursor 58
 - Delete 59
 - File browser 59
 - Help 57
 - Hide/show icons 56
 - Label 58
 - Load saveset 58
 - Measure 59
 - Overview 57
 - Redo 57
 - Run / Stop 58
- Single 58
- Spectrum 59
- Undo 57
- Touch Lock key 41
- Touchscreen
 - Compared with mouse 45
 - Control elements 49
 - Lock, unlock 41
 - Usage 45
- Traces
 - Spectrum 224
- Trigger
 - CAN settings 349
 - Delay (holdoff) 152
 - Edge 138
 - Event (remote) 438
 - Glitch 140
 - Holdoff 152
 - I²C settings 316
 - Information 135
 - Interval 148
 - Label 48
 - Level 47
 - Mode 36, 153
 - Position 47
 - Runt 143
 - Slew rate 150
 - Slope 36
 - Source 36
 - SPI settings 301
 - Timeout 147
 - Width 142
 - Window 145
- Trigger types
 - Width 142
- Trigger Types 136
- Type
 - Trigger 136
- U**
- UART 326
 - Basics 326
 - Configuring 337
 - Decode results 335
 - Triggering 338
- Undo 57
- Unlock touchscreen 41
- Upload data 413
- USB
 - Connector 32
 - Device 33
- V**
- Vertical
 - Controls 37
- VISA
 - Resource string 416
- VNC 45, 413
- W**
- Wait
 - Remote 438
- Waveform export
 - Files and formats 274

| | |
|---------------------------|---------|
| Waveform generator | |
| Settings | 386 |
| Waveforms | |
| Arrange | 54 |
| Channel | 52 |
| Intensity | 41 |
| Math | 52 |
| Minimize | 53 |
| Overview and usage | 52 |
| Reference | 52 |
| Select | 53 |
| States | 53 |
| Style | 86 |
| Switch off | 54 |
| Switch on | 53 |
| Zoom | 52 |
| Zooming | 160 |
| Web browser | 410 |
| Web control | 413 |
| Web interface | 45, 410 |
| Browser | 410 |
| LAN configuration | 410 |
| Width trigger | |
| Trigger | 142 |
| Window trigger | 145 |
| Z | |
| Zone key | 36 |
| Zone trigger | 36 |
| Zoom | 160 |
| MSO | 384 |
| On the touchscreen | 163 |
| Position/Range | 164 |
| Start-stop values | 163 |
| Start/Stop settings | 162 |
| Waveforms | 52 |
| Zoom key | 37 |