

# RM3543

# HIOKI

# RM3543-01

Instruction Manual

# RESISTANCE HiTESTER



**!** Be sure to read this manual before using the instrument. ▶ p.5

**✓** When using the instrument for the first time

Names and Functions of Parts ▶ p.15

Measurement Preparations ▶ p.21

**📖** Troubleshooting

Maintenance and Service ▶ p.183

Error Displays and Remedies ▶ p.185





# Contents

Task-Oriented Reference .....	1
Measurement Flow .....	2
Introduction.....	3
Verifying Package Contents .....	3
Safety Information .....	5
Operating Precautions.....	7

## Chapter 1 Overview 11

1.1 Product Overview and Features .....	11
■ Block Diagram .....	14
1.2 Names and Functions of Parts .....	15
1.3 Screen Organization .....	17

## Chapter 2 Measurement Preparations 21

2.1 Connecting the Power Cord .....	22
2.2 Connecting Measurement Cables and Test Fixtures .....	23
■ Making Your Own Measurement Cables ..	24
2.3 Turning the Power On and Off .....	26

## Chapter 3 Measurement Settings (Basic Measurements) 27

3.1 Pre-Operation Inspection .....	27
3.2 Switching 100 mΩ range Measurement Currents .....	28
3.3 Setting the Measurement Speed .....	29
3.4 Setting Measurement Start Conditions (Trigger Source) .....	30
3.5 Selecting the Measurement Range ....	31
3.6 Zero Adjustment .....	32
3.7 Judging Measured Values (Comparator Function) .....	34
■ Enabling and Disabling the Comparator Function .....	35
■ Decide According to Reference Value and Tolerance (REF% Mode) .....	35

■ Decide According to Upper/Lower Thresholds (ABS Mode) .....	37
3.8 Confirming Faulty Measurements .....	38

## Chapter 4 Customizing Measurement Settings 41

4.1 Making Range-Specific Measurement Settings .....	41
4.2 Setting Pre-Measurement Delay .....	42
4.3 Correcting Measured Values (Scaling Function) .....	44
4.4 Setting the Measurement Integration Time Option .....	46
4.5 Stabilizing Measured Values (Averaging Function) .....	48
4.6 Checking for Poor or Improper Contact (Contact Check Function) .....	49
4.7 Improving Probe Contact (Contact Improver Function) .....	50
4.8 Detecting Measurement Voltage Faults (Voltage Level Monitor Function) .....	52
4.9 Applying Current Only When Measuring (Current Mode Setting) .....	53
4.10 Test for Short-Circuited Probe (Probe Short-Circuit Detection Function) .....	54
4.11 Comparing the Measurement Settings of Two Instruments (Settings Monitor Function) .....	56
4.12 Retrying Measurement After a Fault (Retry Function) .....	59
4.13 Maintaining Measurement Precision (Self-Calibration) .....	60
4.14 Compensating for Thermal EMF Offset (Offset Voltage Compensation - OVC) 61	

## Chapter 5 System Settings 63

5.1 Disabling and Enabling Key Operations .....	63
■ Disabling Key Operations (Key-Lock Function) .....	63

## Contents

---

■ Re-Enabling Key Operations (Key-Lock Cancel) .....	64
5.2 Setting the Comparator Decision and Key Beepers .....	65
■ Enabling or Disabling the Key Beeper .....	65
■ Setting the Comparator Decision (“JUDGE”) Beeper .....	66
5.3 Power Line Frequency Manual Setting .....	67
5.4 Setting the Clock .....	68
5.5 Adjusting Screen Contrast .....	69
5.6 Adjusting the Backlight .....	70
5.7 Initializing (Reset) .....	71
■ Default Settings .....	72

---

## Chapter 6 Storing and Exporting Data 73

6.1 Storing Data at Specific Times (Data Memory Function) .....	74
6.2 Store as soon as Measurement is Stable (Auto-Memory Function) .....	75
6.3 Performing Statistical Calculations on Measured Values .....	78
■ Using Statistical Calculations .....	79
■ Confirming, Printing, and Erasing Calculation Results .....	80
6.4 Auto-Exporting Measured Values (at End of Measurement) (Data Output Function) .....	81

---

## Chapter 7 Printing 83

7.1 Connecting the Printer .....	83
■ Connecting the Printer to the Instrument .....	84
7.2 Instrument Settings .....	85
7.3 Printing .....	86
■ Printing Measured Values and Comparator Decisions .....	86
■ Printing Statistical Calculation Results .....	86

---

## Chapter 8 External Control 89

8.1 External Input/Output Connector and Signals .....	89
■ Connector Type and Signal Pinouts .....	90

■ Signal Descriptions .....	91
8.2 Timing Chart .....	92
8.3 Internal Circuitry .....	94
■ Electrical Specifications .....	95
■ Connection Examples .....	96
8.4 External I/O Settings .....	97
■ Setting End-of-Measurement Signal Output (EOM Signal Setting) .....	97
■ Setting the Trigger ( $\overline{\text{TRIG}}$ ) Signal Logic .....	98
8.5 External Control Q&A .....	99
8.6 Supplied Connector Assembly .....	100

---

## Chapter 9 Communications (RS-232C/ GP-IB Interface) 101

9.1 Overview and Features .....	101
9.2 Specifications .....	102
9.3 Connecting .....	103
■ Using the RS-232C Interface .....	103
■ Using the GP-IB Interface (RM3543-01 only) .....	104
9.4 Configuring the Communications Protocol .....	105
■ Configuring RS-232C Interface Communications .....	105
■ Configuring GP-IB Interface Communications (RM3543-01 only) .....	106
■ Select the Measurement Data Transmission Format (both RS-232C and GP-IB) .....	107
9.5 Communication Methods .....	108
■ To cancel the Remote state (enter the local state) .....	108
■ Message Format .....	109
■ Output Queue and Input Buffer .....	112
■ Status Byte Register .....	113
■ Event Registers .....	115
■ Initialization Items .....	118
■ Command Execution Time .....	119
■ Errors During Communications .....	119
9.6 Message List .....	120
■ Standard Commands .....	120
■ Device-Specific Commands .....	121
9.7 Message Reference .....	126
■ Message Reference Interpretation .....	126
■ Standard Commands .....	127
■ Device-Specific Commands .....	131
9.8 Data Exporting Methods .....	152

---

9.9	Sample Programs .....	154
■	Using Visual Basic 5.0 or 6.0 .....	154
■	Creation Procedure (Visual Basic 2005) ..	164
■	Sample Programs (Visual Basic 2005) ...	166
9.10	Device Compliance Statement.....	168

---

## **Chapter 10 Specifications 171**

---

## **Chapter 11 Maintenance and Service 183**

11.1	Troubleshooting .....	183
■	Inspection and Repair .....	183
11.2	Cleaning .....	184
11.3	Error Displays and Remedies .....	185
11.4	Disposing of the Instrument .....	187
■	Removing the Lithium Battery .....	187

---

## **Appendix A 1**

Appendix 1	Four-Terminal (Voltage-Drop) Method.....	A 1
Appendix 2	Effect of Thermal emf .....	A 2
Appendix 3	Unstable Measurement Values.	A 3
Appendix 4	Effects of Probing .....	A 9
Appendix 5	Rack Mounting.....	A 11
Appendix 6	Dimensional Diagram .....	A 13
Appendix 7	Calibration.....	A 14
Appendix 8	Adjustment Procedure .....	A 16
Appendix 9	Table of Commands Compatible with the ADEX AX-1152D .....	A 17
Appendix 10	Zero Adjustment.....	A 19

---

## **Index Index 1**

---



## Task-Oriented Reference

### To minimize measurement error

- ▶ Setting the measurement speed (p. 29)
- ▶ Setting the averaging function (p. 48)
- ▶ Setting the measurement speed integration time option (p. 46)
- ▶ Correcting measured values (p. 44)
- ▶ Zero-adjustment (p. 32)

### To judge measurement results

- ▶ Judge measured values (comparator function) (p. 34)
- ▶ Compare the measurement settings of two instruments (Settings Monitor function) (p. 56)

### To correct faulty measurements

- ▶ Confirm faulty measurement (p. 38)
- ▶ Improve probe contact (Contact Improver function) (p. 50)
- ▶ Test for short-circuited probe (probe short-circuit detection function) (p. 54)
- ▶ Compare the measurement settings of two instruments (Settings Monitor function) (p. 56)

### To automatically store measured values

- ▶ Store as soon as measurement is stable (Auto Memory function) (p. 75)

### To print measurement results

- ▶ Printing (p. 83)

### To measure by PLC connection (PLC: Programmable Logic Controller)

- ▶ External control (p. 89)
- ▶ Communications (RS-232C/GP-IB interface) (p. 101)

### To connect to a computer

- ▶ Communications (RS-232C/GP-IB interface) (p. 101)

### To automatically send measurement data to a computer (RS-232C interface only)

- ▶ Export measurement values automatically (when finished measuring) (p. 81)

### To check operation

- ▶ Setting Measurement Start Conditions (Trigger Source) (p. 30)  
Internal trigger (INT)
- ▶ Calibration (p. A14)

# Measurement Flow

Be sure to read the "Operating Precautions" (p. 7) before use.

## Installing, Connecting and Turning On

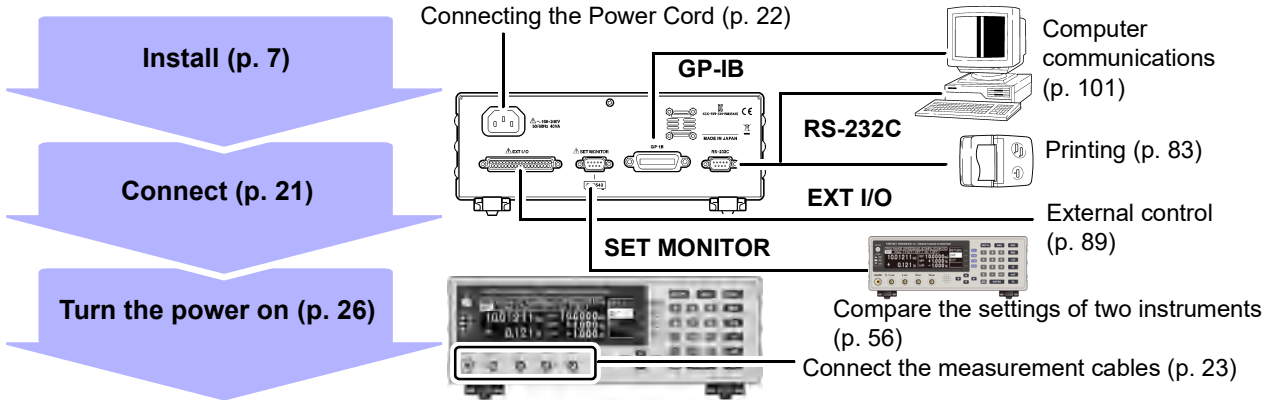

## Settings

**Set measurement conditions (as needed)**

Confirm the screen configuration (p. 17)

Confirm the initial setup (p. 72)

- Basic Settings (p. 27)
- Configure settings for your specific conditions (p. 41)
- System-related settings (p. 63)

When changing settings

Change basic settings such as measurement speed

Change to detailed settings (measurement conditions and system-related)

**Set decision criteria (p. 34)**

## Calculation, Printing, Communication, and External Control Settings

Statistical calculations (p. 78)

Data transmission (p. 81)

Printing (p. 83)

Computer communications (p. 101)

External control (p. 89)

Instrument interface settings must be configured before printing or using communications or remote control.

## When Finished

Turn the power off (p. 26)



## Introduction

Thank you for purchasing the HIOKI Model RM3543/ RM3543-01 Resistance HiTester. To obtain maximum performance from the instrument, please read this manual first, and keep it handy for future reference.

Model RM3543-01 is the same as the RM3543, but with GP-IB included.

### Registered trademarks

- Microsoft, Windows and Visual Basic are either registered trademarks or trademarks of Microsoft Corporation in the United States and other countries.
- Other products and company names are trade names, registered trademarks, or trademarks of their respective owners.

## Verifying Package Contents

### Inspection

When you receive the instrument, inspect it carefully to ensure that no damage occurred during shipping. In particular, check the accessories, panel switches, and connectors. If damage is evident, or if it fails to operate according to the specifications, contact your dealer or Hioki representative.

### Content confirmation

Confirm that these contents are provided.

- Model RM3543 or  
RM3543-01 (with GP-IB included)..... 1



- Power Cord (2-line + ground)(p. 22)  
 EXT I/O Male Connector (p. 100)

- Instruction Manual (This document)..... 1

- Operation Guide..... 1

### Options

The following options are available for the instrument. Contact your authorized Hioki distributor or reseller when ordering.

The options are subject to change. Visit our website for updated information.

#### Measurement Probes and Fixtures

(connect to measurement jacks)

- Model 9140 4-terminal Probe

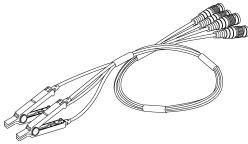

Alligator-clip-type measurement probes. These general-purpose dual-electrode clips fit a wide range of conductor thicknesses.

- Model 9500 4-terminal Probe

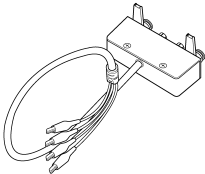

Rubber-sheathed alligator-clip-type measurement probes. This design is ideal for 4-terminal-pair resistance measurement applications, for example measuring standard resistors

- Model 9262 Test Fixture

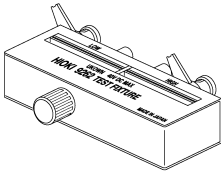

This fixture is for measuring lead components. (less than 10 mΩ residual resistance after zero adjustment)

- Model 9263 SMD Test Fixture

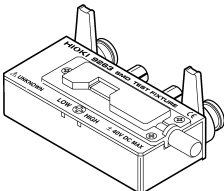

This fixture is for measuring chip components. (less than 10 mΩ residual resistance after zero adjustment)

#### Interface Cables

- Model 9637 RS-232C Cable (9-pin to 9-pin/ crossover cable)
- Model 9638 RS-232C Cable (9-pin to 25-pin/ crossover cable)
- Model 9151-02 GP-IB Connector Cable (2m)

## Safety Information



This instrument is designed to comply with IEC 61010 Safety Standards, and has been thoroughly tested for safety prior to shipment. However, mishandling during use could result in injury or death, as well as damage to the instrument. Using the instrument in a way not described in this manual may negate the provided safety features. Be certain that you understand the instructions and precautions in the manual before use. We disclaim any responsibility for accidents or injuries not resulting directly from instrument defects.

This manual contains information and warnings essential for safe operation of the instrument and for maintaining it in safe operating condition. Before using it, be sure to carefully read the following safety precautions.

### Safety Symbols



Indicates the need for caution or the presence of danger. For more information about locations where this symbol appears on instrument components, see the "Operating Precautions" (p. 7), warning messages listed at the beginning of operating instructions.



Indicates AC (Alternating Current).

The following symbols in this manual indicate the relative importance of cautions and warnings.



Indicates that incorrect operation presents a significant hazard that could result in serious injury or death to the user.



Indicates that incorrect operation presents a possibility of injury to the user or damage to the instrument.



Indicates advisory items related to performance or correct operation of the instrument.

### Symbols for Various Standards



This symbol indicates that the product conforms to regulations set out by the EC Directive.



WEEE marking:

This symbol indicates that the electrical and electronic appliance is put on the EU market after August 13, 2005, and producers of the Member States are required to display it on the appliance under Article 11.2 of Directive 2002/96/EC (WEEE).

## Other Symbols



Indicates a prohibited action.

(p. )

Indicates the location of reference information.

\*

Indicates that descriptive information is provided below.

[ ]

Square brackets indicate instrument display labels (such as setting item names).

**SET**

Bold characters within the text indicate operating key labels.

(Bold characters)

Unless otherwise specified, "Windows" represents Windows 95, 98, Me, Windows NT4.0, Windows 2000, Windows XP, or Windows Vista.

Click: Press and quickly release the left button of the mouse.

Double click: Quickly click the left button of the mouse twice.

## Accuracy

We define measurement tolerances in terms of f.s. (full scale), rdg. (reading) and dgt. (digit) values, with the following meanings.

<b>f.s.</b>	(maximum display value) The maximum displayable value. This is usually the name of the currently selected range.
<b>rdg.</b>	(reading or displayed value) The value currently being measured and indicated on the measuring instrument.
<b>dgt.</b>	(resolution) The smallest displayable unit on a digital measuring instrument, i.e., the input value that causes the digital display to show a "1" as the least-significant digit.

## Operating Precautions



Follow these precautions to ensure safe operation and to obtain the full benefits of the various functions.

### Preliminary Checks

- Before using the instrument for the first time, verify that it operates normally to ensure that no damage occurred during storage or shipping. If you find any damage, contact your dealer or Hioki representative.
- Before using the instrument make sure that the insulation on the power cord is undamaged and that no bare conductors are improperly exposed. Using the instrument in such conditions could cause an electric shock, so contact your dealer or Hioki representative for repair.
- Before using the instrument, make sure that the insulation on the measurement cables is undamaged and that no bare metal is improperly exposed. If there is any damage, measured values may be unstable and measurement errors may occur.

### Instrument Installation

Storage temperature and humidity : -10°C to 50°C at 80% RH or less (non-condensating)

Operating temperature and humidity : 0 to 40°C at 80% RH or less (non-condensating)

Avoid the following locations that could cause an accident or damage to the instrument.

	Exposed to direct sunlight Exposed to high temperature		In the presence of corrosive or explosive gases
	Exposed to water, oil, other chemicals, or solvents Exposed to high humidity or condensation		Exposed to strong electromagnetic fields Near electromagnetic radiators
	Exposed to high levels of particulate dust		Near induction heating systems (e.g., high-frequency induction heating systems and IH cooking utensils)
	Subject to vibration		

### Installation Precautions

- The instrument should be operated only with the bottom downwards.
- Do not place the instrument on an unstable or slanted surface.
- **Vents must not be obstructed.**

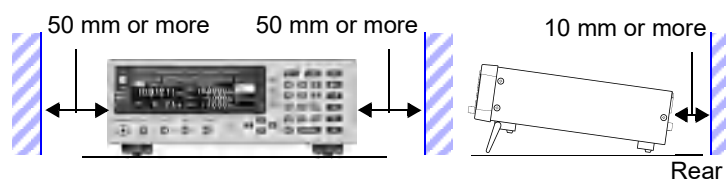

The instrument can be used with the stand (p. 16).  
It can also be rack-mounted. (p. A11).

Unplugging the power cord kills power to the instrument. Be sure to provide enough unobstructed space to unplug the power cord immediately in an emergency.

**Handling the Instrument****!WARNING**

- Do not allow the instrument to get wet, and do not take measurements with wet hands. This may cause an electric shock.
- Do not attempt to modify, disassemble or repair the instrument; as fire, electric shock and injury could result.

**!CAUTION**

To avoid damage to the instrument, protect it from physical shock when transporting and handling. Be especially careful to avoid physical shock from dropping.

**NOTE**

This instrument may cause interference if used in residential areas. Such use must be avoided unless the user takes special measures to reduce electromagnetic emissions to prevent interference to the reception of radio and television broadcasts.

**Handling the Cords and Probes****!CAUTION**

- Avoid stepping on or pinching cables, which could damage the cable insulation.
- To avoid breaking the cables, do not bend or pull them.
- To avoid damaging the power cord, grasp the plug, not the cord, when unplugging it from the power outlet.
- When disconnecting the BNC connector, be sure to release the lock before pulling off the connector. Forcibly pulling the connector without releasing the lock, or pulling on the cable, can damage the connector (p. 23).

**NOTE**

- Use only the specified connection cables. Using a non-specified cable may result in incorrect measurements due to poor connection or other reasons.
- Before using a test fixture, read the instructions provided with it.

**Before Turning Power On****!WARNING**

Before turning the instrument on, make sure the supply voltage matches that indicated on its power connector. Connection to an improper supply voltage may damage the instrument and present an electrical hazard.

## Before Connecting EXT I/O

### **⚠ WARNING**

To avoid electric shock or damage to the equipment, always observe the following precautions when connecting to the EXT I/O connector.

- Always turn off the power to the instrument and to any devices to be connected before making connections.
- Be careful to avoid exceeding the ratings of external terminals (p. 95).
- During operation, a wire becoming dislocated and contacting another conductive object can be serious hazard. Use screws to secure the external connectors.
- Ensure that devices and systems to be connected to the EXT I/O terminals are properly isolated.
- The ISO\_5V pin of the EXT I/O connector is a 5 V power output, and the ISO\_12V pin is a 12 V power output. Do not apply external power to this pin.

### **⚠ CAUTION**

To avoid damage to the instrument, observe the following cautions:

- Do not apply voltage or current to the EXT I/O terminals that exceeds their ratings.
- When driving relays, be sure to install diodes to absorb counter-electromotive force.
- Be careful not to short-circuit ISO\_5V to ISO\_COM.
- Be careful not to short-circuit ISO\_12V to ISO\_COM.
- Do not draw loads from ISO\_5V and ISO\_12V at the same time.

**See:** "Connector Type and Signal Pinouts" (p. 90)

## Before Measuring

### **⚠ CAUTION**

- Do not apply any voltage to the measurement jacks. Doing so could damage the instrument.
- Never attempt to measure at a point where voltage is present. In particular, do not measure a transformer or motor immediately after a temperature increase test or withstand-voltage test, as the instrument could be damaged by induced voltage or residual charge.
- Battery internal resistance cannot be measured with this instrument. It will sustain damage. To measure battery internal resistance, we recommend the HIOKI 3554, 3555, BT3562, BT3563, and 3561 Battery HiTesters.

### **NOTE**

- To obtain the guaranteed measurement accuracy, allow at least 30 minutes warm-up.
- The instrument internally retains all settings (but not measured values), such as measurement range and comparator settings. However, measurement settings made through the RS-232C or GP-IB interface are not memorized.
- The DC resistance of a power transformer cannot be measured. Do not measure objects with a large L (100  $\mu$ H or higher in the 10 m $\Omega$  to 100  $\Omega$  range, or 10  $\mu$ H or higher in the 1,000  $\Omega$  range), such as choke coils and other inductors. In such cases, contact your dealer or Hioki representative.
- You may be unable to obtain accurate measured values when there is a capacitance component in parallel with the measurement target. For this instrument, any parallel capacitance component should be limited to a maximum of 1,000 pF.
- Carefully insulate all H<sub>CUR</sub>, H<sub>POT</sub>, L<sub>POT</sub>, and L<sub>CUR</sub> wiring. Proper 4-terminal measurements cannot be performed and an error will occur if core and shield wires touch.
- During measurement, a transient current equal to about 1.5 times the steady-state current will flow for several microseconds (or about 10 mA<sub>pk</sub> in the 1 k $\Omega$  range). Exercise special care when measuring targets whose characteristics are prone to vary.

# 10

## *Operating Precautions*

---

---



# Overview

# Chapter 1

1

## 1.1 Product Overview and Features

The Hioki RM3543 Resistance HiTester employs the 4-terminal method to quickly and accurately measure the DC resistance of components such as resistors and current sensing resistors. It includes advanced contact-check, comparator, and data output functions. The intuitive user interface and high noise immunity are ideal for use with taping machines and separators.

### Resistance Measurement

The factory defaults (initial settings) are optimized for current sensing resistors measurements.

Optional Hioki probes and fixtures are available to connect to the measurement jacks (BNC jacks, p. 4). Alternatively, commercially available cables such as 1.5D-2V coax can be used (p. 24).

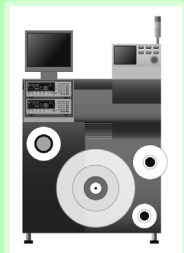

### Judge Measured Values

Measured values are compared with a pre-specified reference value or thresholds, and the result is output externally and indicated by the COMP indicators (comparator function, p. 34).



### Save and Output Measured Values

Measured values can be stored in internal memory (p. 73). Statistical calculations can be performed on the stored data, which can be transferred to a computer in batch form (however, stored data cannot be confirmed internally).

### Send Measurement Data and Calculation Results to a Printer

Use a commercially available printer with a serial interface to print measured values and calculation results (p. 83).

### Connect a PLC or I/O Board

To control from a PLC, connect to the EXT I/O connector. In addition to comparator results, various measurement anomaly signals can be output (p. 89).

### Compare Two Instrument's Setting Conditions

When measuring with two interconnected instruments, settings are compared, and an alarm is output and measurement is inhibited if the settings differ (Settings Monitor function, p. 56).

### Interface Communications

Connect the instrument to a controller via the RS-232C or GP-IB interface to control measurement data acquisition (p. 101).

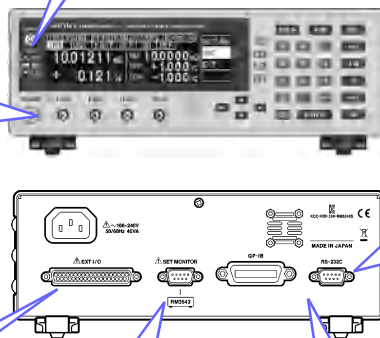

### Features

#### Ultra Fast and Accurate Measurements Increase Productivity

The RM3543 is ideally suited for use in testing current sensing resistors, where there has been remarkable progress in lowering resistance values.

Measurement from which the effects of thermal EMF are consistently eliminated (by the OVC function) yields a resolution of 0.01  $\mu\Omega$  in the 10 m $\Omega$  range.

Since measurement results are obtained by means of a PASS/FAIL judgment process with a resolution of 0.001%, the instrument can test resistors of 1 m $\Omega$  and less at a high rate of speed. Thanks to proprietary ultra-fast, high-stability circuit technology, the RM3543 completes the sequence of contact improvement, measurement and contact check, and judgment output in just 1.6 ms.

#### Multiple Interfaces

EXT I/O is isolated from the measurement and control circuits to provide noise immunity (p. 89).

All data can be acquired in real time using the built-in 38.4-kbps high-speed RS-232C interface. Connect the commercially available printer with a serial interface to print measured values and statistical calculation results (p. 83).

The GP-IB interface is available for Model RM3543-01 (specified when ordering, p. 101).

#### Clearly Visible Display and Intuitive Operation

High-contrast LCD provides clear visibility, helping avoid setting mistakes. The optimum range is selected automatically when comparator thresholds are entered.

INTI 10m $\Omega$	FAST	OVC	MENU
10.01211 m $\Omega$	REF 10.0000 m $\Omega$		
+ 0.121 %	UPP +1.000 %		
	LOW -1.000 %		

#### Fixtures for Component Measurements (p. 4)

The BNC-type measurement jacks exhibit good noise immunity. Ready availability and easy assembly ensure smooth system setup. Various test fixtures are available for Hioki LCR HiTesters.

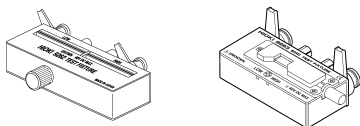

#### Specially designed for current sensing resistors

Thanks to its scaling function, the RM3543 can compensate for the difference between resistance values obtained at the time of mounting on the board and during testing. By using the averaging function during super-low-resistance measurement with a small detection voltage, it is possible to achieve even higher levels of accuracy.

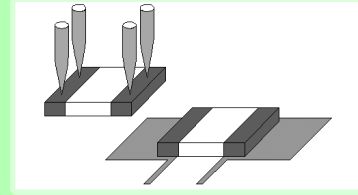

#### High-Speed Data Output and Ample Memory

The Data Output function transfers measured data at 5 ms/sample, even via RS-232C. Up to 30,000 measurements can be stored, and all data can be exported at the end of measuring each reel. This function is ideal for system setup, debugging and process management.

#### Auto Memory Function Convenient for Sampling Tests (p. 75)

The auto memory function is convenient for sampling tests after screen-printing. Measured values are automatically acquired as soon as they stabilize, and statistical calculations proceed until the specified quantity is obtained, upon which an alert notification (alarm) occurs. Selecting [PRINT] (screen display) prints measured values and statistical calculation results (p. 86).

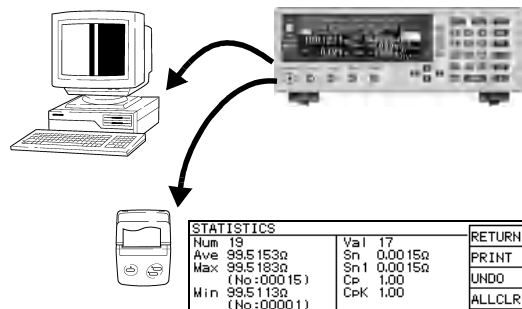

Features

**Reliable Contact Checking (p. 49)**

Contact checking (that was previously performed before and after measuring) is now performed during measurement, so probe bounce and contact resistance fluctuations can be detected. Contact checking time can be shortened, improving tact times.

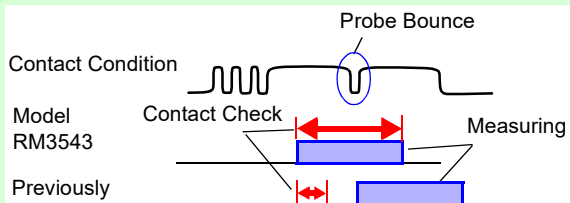

**Minimize Human Error and Risk – the Settings Monitor Function (p. 56)**

If the settings of two instruments are different, triggering is inhibited and an alarm notification is generated to avoid setting mistakes due to human error.

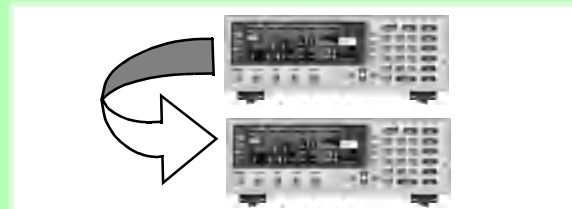

**Reject Faulty Data – Voltage Level Monitor Function (p. 52)**

When the contact resistance of the  $H_{CUR}$  and  $L_{CUR}$  leads fluctuates, the measurement current changes momentarily. Such momentary changes are not detectable by typical contact checking. The Voltage Level Monitor function detects a contact error if the detection voltage changes significantly, which can increase the reliability of measured values.

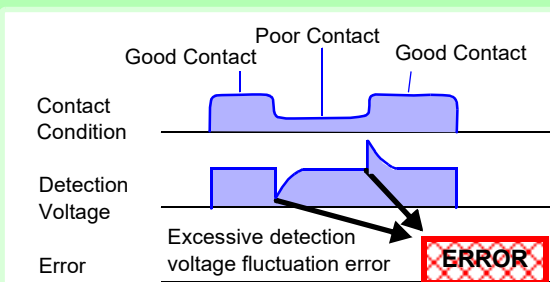

**Reliable Four-Terminal Measurement – Probe Short-Circuit Detection Function (p. 54)**

Four-terminal measurements are inhibited when a conductive foreign object is present between the POT and CUR probe tips. Short-circuit probe anomalies are detected by checking the resistance between these tips when not measuring.

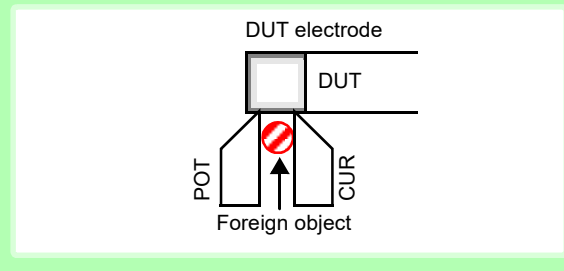

**Measurement Circuit Strongly Immune to Contact Resistance Fluctuations**

The effects of contact resistance fluctuations are reduced even when scattering occurs near the end of probe life. Such effects are minimized by the fast response of the measurement circuit.

**Contact Improver Function (p. 50)**

The Contact Improver function improves bad contacts between probes and test samples. Contacts errors are reduced by penetrating oxidation and impurities between probes and samples. Reducing contact errors can increase productivity and quality. The intensity of the contact improver function can be adjusted according to probe type.

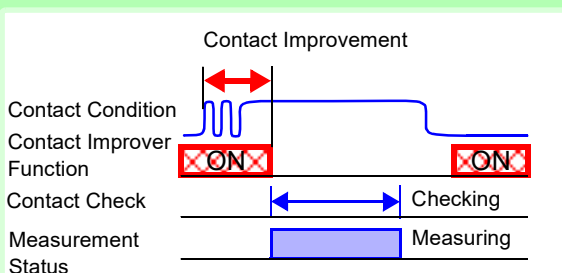

**Strong Electrical Noise Immunity**

The specified measurement accuracy is achieved even with  $\pm 1.5$  kV mixed pulse noise. The floating measurement section design is highly impervious to electrical noise, minimizing the effect on measured values even when turning large-induction motors on and off. The free-range power supply input (90 to 264 V) is practically unaffected by voltage fluctuations, so stable measurements are possible even in under poor power conditions.

## Block Diagram

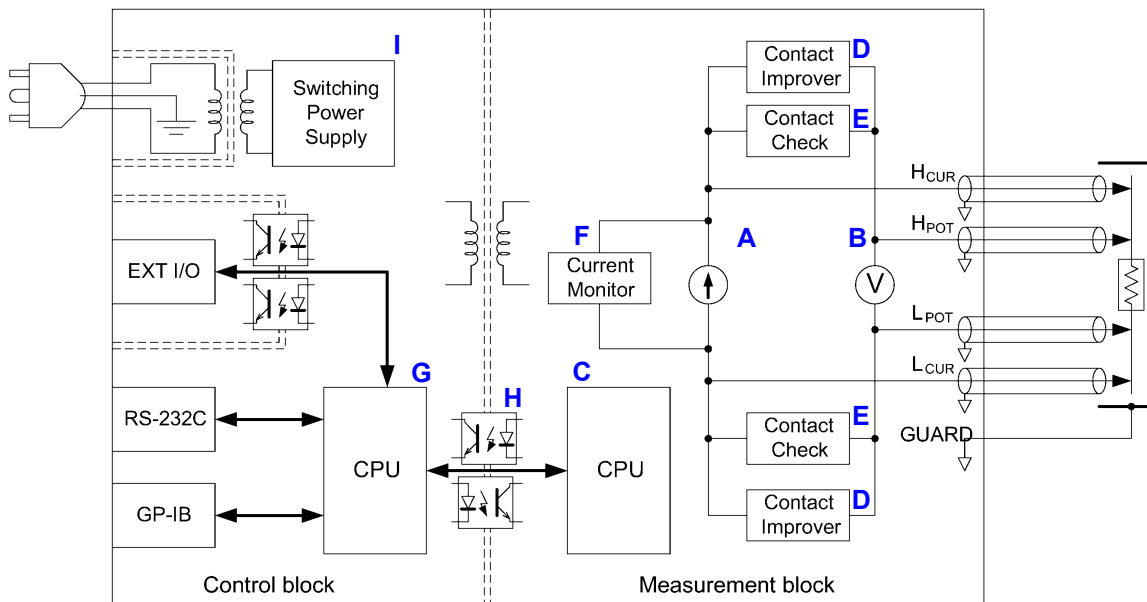

- Constant current (determined by the measurement range) is applied between the H<sub>CUR</sub> and L<sub>CUR</sub> terminals while voltage is measured between the H<sub>POT</sub> and L<sub>POT</sub> terminals. The resistance value is obtained by dividing the measured voltage (B) by the constant current flow (A).
- The effects of large offset voltage such as from thermal emf are reduced by current flowing in the positive and negative directions (A).
- The constant current source (A) and voltmeter (B) circuit designs are largely unaffected by contact resistance.
- Faulty measurement values caused by unstable or chattering contact conditions can be eliminated by monitoring (C) the detection voltage (B) waveform (Voltage Level Monitor function).
- Before measuring, the Contact Improver circuit (D) optimizes contact when the probes touch the DUT.
- By also performing contact checking (E), short circuits between CUR and POT terminals caused by a clogged probe tip can be detected (probe short-circuit detection function).
- When measurement starts, the contact check circuit (E) and constant current monitor (F) are activated to monitor for fault conditions while measuring. The dual-CPU (C and G) design provides ultra-high-speed measurements and fast system response.
- Immunity from electrical noise is provided by isolation between the Measurement and Control blocks (H).
- The auto-ranging 100-to-240 V switching power supply (I) can provide stable measurements even in poor power quality environments.

## 1.2 Names and Functions of Parts

1

### Front Panel

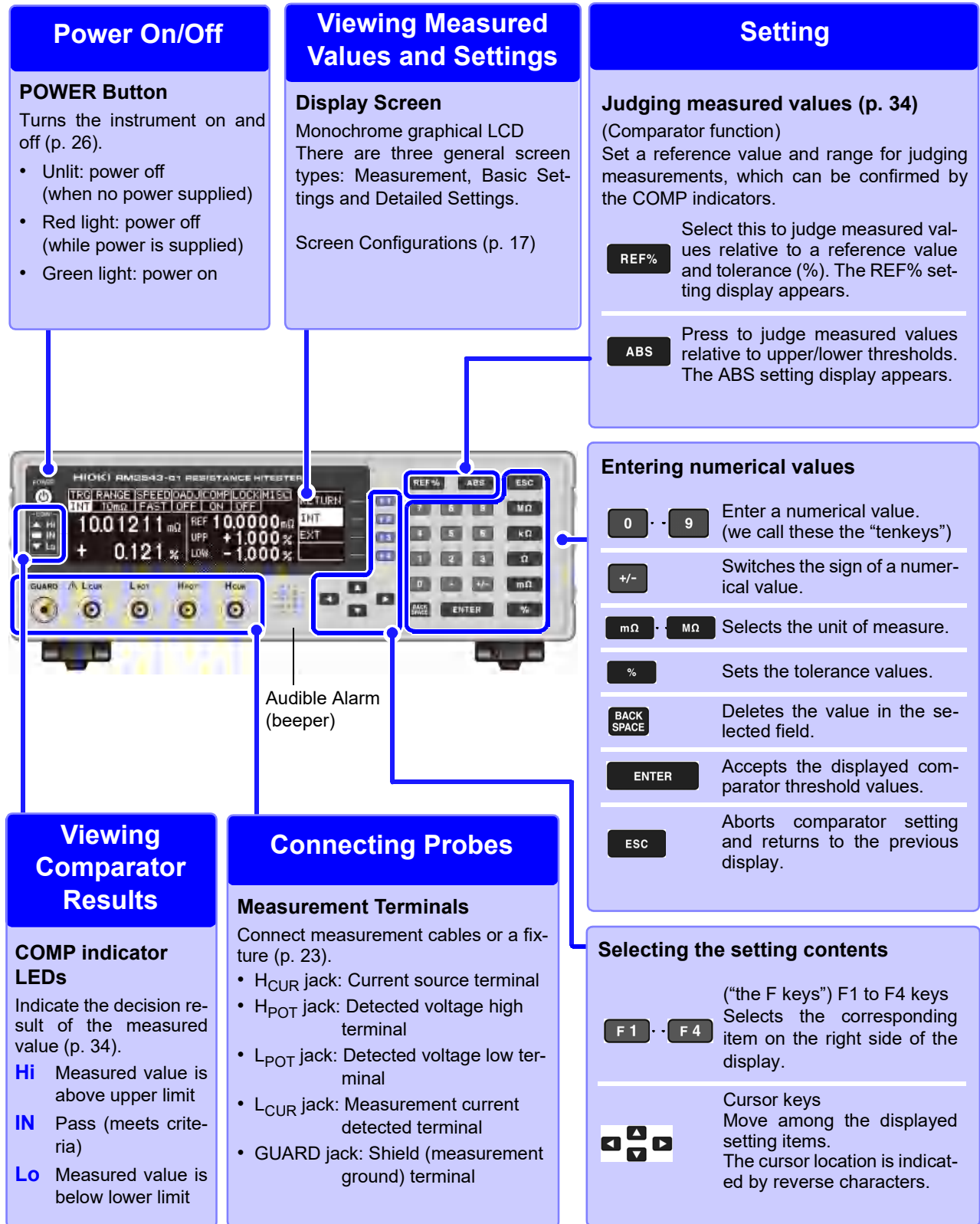

### Rear Panel

#### Connecting the Power Cord

Connect the supplied power cord (p. 22).

#### Manufacturer's Serial Number

Shows the serial number. The 9-digit serial number indicates the year (first two digits) and the month of manufacture (next two digits).

Do not remove this label, as it is required for product support.

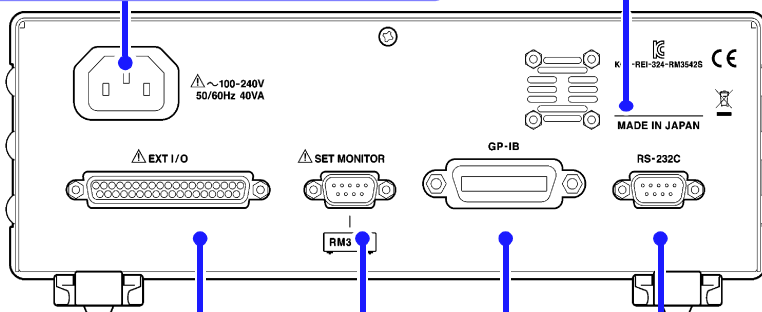

#### External Control

##### EXT I/O Connector

Connect to a PLC or I/O board to control measurement start, and to acquire comparator results (p. 89).

#### RS-232C Communications Printer Output

##### RS-232C Connector

The RS-232C interface can be used to connect to a PLC or computer (p. 101). It is also used by the commercially available printer with a serial interface (p. 83).

#### Compare Two Instruments' Settings

##### SET MONITOR Connector

Connect another RM3543 here to compare instrument settings (p. 56).

#### GP-IB Communications

##### GP-IB Connector (RM3543-01 only)

The GP-IB interface can be used to connect to a computer (p. 101).

### Bottom Panel

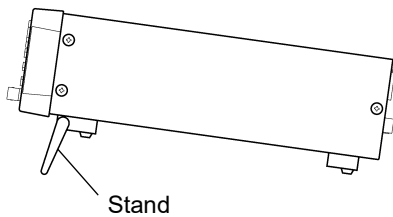
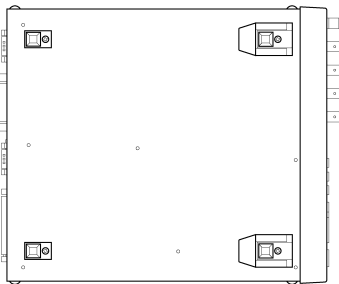

This instrument can be rack mounted.

See: "Appendix 5 Rack Mounting" (p. A11)

Parts removed from this instrument should be stored in a safe place to enable future reuse.

#### When using the stand

Extend the stand until it clicks into place. Make sure to extend both legs of the stand.

#### Collapsing the stand

Fold in the stand until it clicks into place.

#### **CAUTION**

Do not apply heavy downward pressure with the stand extended. The stand could be damaged.

# 1.3 Screen Organization

The instrument has three general display screen types: Measurement, Basic Settings and Detailed Settings.

Refer to "11.3 Error Displays and Remedies" (p. 185) for error displays.

The screen examples in this guide appear reversed (black on white) for best visibility on the printed page. However, the instrument screens can actually be displayed only as white characters on black background.

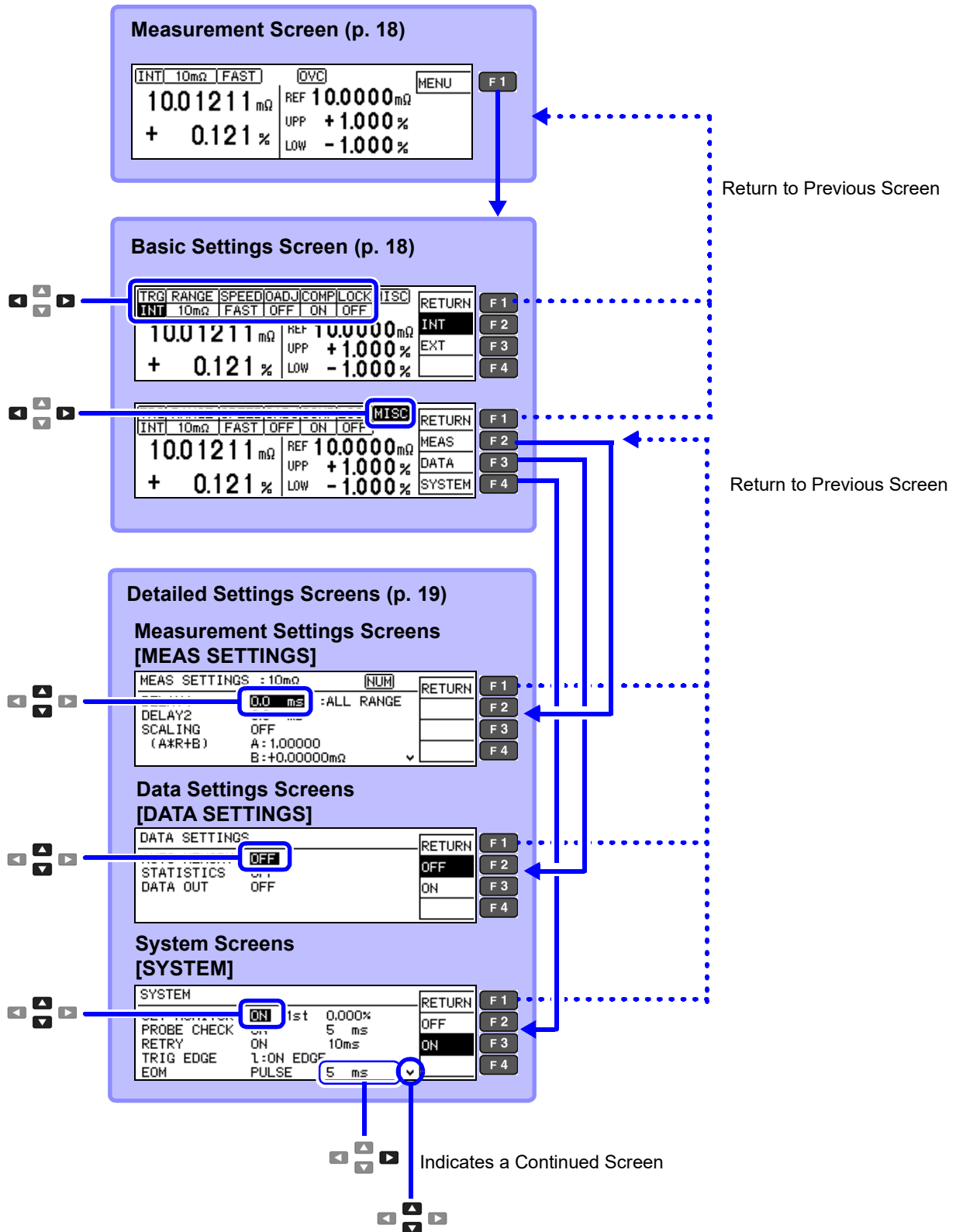

### Measurement Screen

The screenshot shows the Measurement Screen with the following elements:

- Measured Value:** 10.01211 mΩ
- Criteria Setting Values:** REF 10.0000 mΩ, UPP +1.000%, LOW -1.000%
- Measurement Conditions:** INT 10mΩ, FAST, OVC
- Buttons:** MENU (F1)

#### Measurement Conditions

Shows current setting contents. Displayed contents depend on the current settings.

<b>INT/ EXT</b>	Trigger source type (p. 30)
<b>Ω</b>	Measurement range (p. 31)
<b>FAST/ MED/ SLOW</b>	Measurement speed (p. 29)
<b>0ADJ/ OFF (not shown)</b>	Appears only when zero-adjust is enabled (p. 32)
<b>OVC/ OFF (not shown)</b>	(OVC: Offset Voltage Compensation) Appears only when OVC is enabled (p. 61)
<b>SC/ OFF (not shown)</b>	Appears only when the scaling function is enabled (p. 44)
<b>NUM</b>	Appears only when tenkey input is enabled
<b>RMT</b>	Remote control (p. 108)
<b>M.LOCK</b>	Disables all operations except comparator settings (p. 63)
<b>F.LOCK</b>	Disables all operations including comparator settings (p. 63)

This screen normally appears while measuring. View currently measured values and measurement conditions. Some parts of the display depend on the comparator mode and other settings.

#### To display the Basic Settings screen

#### Settings Menu (corresponding to F keys)

Displayed contents depend on the current function settings.

Parentheses ( ) indicate the corresponding F-key

<b>MENU (F1)</b>	Displays the Basic Settings screen
<b>PRINT (F2)</b>	Print (p. 85) Appears only when the interface is set for the printer
<b>STAT (F3)</b>	Statistical calculation results (p. 78) Appears only when statistical calculation is enabled
<b>NUMBER (F4)</b>	Set Auto-Memory number (quantity) (p. 75) Displays the number of stored data items and the number of passed and failed products at the lower left.
<b>UNDO (F3)</b>	Deletes the previously stored measurement and calculation result (only one can be deleted) (p. 80) Appears only when calculation results are displayed
<b>ALLCLR (F4)</b>	Clears all memory and calculation (p. 80) Appears only when calculation results are displayed
<b>LOCAL (F1)</b>	Enables local control (p. 108)
<b>UNLOCK (F1)</b>	Cancels the key-lock state (hold 1s) (p. 64)

### Basic Settings Screen

Return to previous screen

The screenshot shows the Basic Settings Screen with the following elements:

- Measurement Condition Settings:** TRG RANGE SPEED 0ADJ COMP LOCK MISC, INT 10mΩ FAST OFF ON OFF
- Measurement Condition Setting Selections:** RETURN (F1), INT (F2), EXT (F3), F4
- Buttons:** Select measurement condition settings (Move with cursor keys), Measurement condition setting selections

Make basic measurement condition settings on this screen. Measurement speed and range can be changed while viewing measured values. (Trigger source: INT)

<b>TRG</b>	Change trigger source (measurement start control method) (p. 30) When EXT triggering is enabled, [MANU] appears beside the F4 key (press to trigger measurement manually).
<b>RANGE</b>	Change range (p. 31)
<b>SPEED</b>	Change measurement speed (p. 29)
<b>0ADJ</b>	Turn zero-adjust on/off (p. 32)
<b>COMP</b>	Turn comparator on/off (p. 34)
<b>LOCK</b>	Enable/disable key lock (p. 63)
<b>MISC</b>	To display the Detailed Settings screen

The screenshot shows the Basic Settings Screen with the following elements:

- Measurement Condition Settings:** TRG RANGE SPEED 0ADJ COMP LOCK MISC, INT 10mΩ FAST OFF ON OFF
- Measurement Condition Setting Selections:** RETURN (F1), MEAS (F2), DATA (F3), SYSTEM (F4)
- Buttons:** Select measurement condition settings (Move with cursor keys), Measurement condition setting selections

<b>MEAS (F2)</b>	To display the [MEAS SETTINGS] screen
<b>DATA (F3)</b>	To display the [DATA SETTINGS] screen
<b>SYSTEM (F4)</b>	To display the [SYSTEM] screen



## Detailed Settings Screens

1

### Measurement Settings Screen [MEAS SETTINGS]

MEAS SETTINGS : 10mΩ			RETURN
DELAY1	0.0 ms	:ALL RANGE	↑
DELAY2	0.0 ms		
SCALING	OFF		
(A*R+B)	A: 1.00000		
	B: +0.00000mΩ		

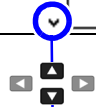

MEAS SETTINGS : 10mΩ			RETURN
AVERAGE	ON	16Times	OFF
CONT CHECK	ON	100Ω	
CONT IMP	ON	35mA	
VOLT MONITOR	ON	NORMAL	ON
CURRENT MODE	PULSE		

Shows detailed settings for measurements.

Adjust the measurement speed, stability and measurement fault detection functions.

<b>DELAY1</b>	Adjust the delay from probing to trigger input (p. 42)
<b>DELAY2</b>	Adjust measurement object electrical response (p. 42)
<b>SCALING(A*R+B)</b>	Correct measured values with the scaling function (p. 44)
<b>INT (FAST/ MED/ SLOW)</b>	Make fine adjustment to integration time (p. 46)
<b>AVERAGE</b>	Stabilize measured values with the averaging function (p. 48)
<b>CONT CHECK</b>	Contact check threshold setting (p. 49)
<b>CONT IMP</b>	Contact Improver function setting (p. 50)
<b>VOLT MONITOR</b>	Voltage level monitor function setting (p. 52)
<b>CURRENT MODE</b>	Current mode setting (p. 53)

### Data Settings Screen (Save, Analysis, and Output) [DATA SETTINGS]

DATA SETTINGS			RETURN
AUTO MEMORY	OFF		OFF
STATISTICS	OFF		
DATA OUT	OFF		ON

These are settings for memory and statistical calculation functions.

<b>AUTO MEMORY</b>	Turn Auto-Memory on/off (p. 75)
<b>STATISTICS</b>	Statistical calculation on/off (p. 78)
<b>DATA OUT</b>	Automatically output measured values (communications) (p. 81)

## System Screen [SYSTEM]

SYSTEM				RETURN
SET MONITOR	OFF			OFF
PROBE CHECK	OFF			ON
RETRY	ON	50ms		
TRIG EDGE	1:ON EDGE			
EOM	PULSE	5 ms	▼	

Set instrument system-related settings on this screen.

<b>SET MONITOR</b>	Turn two-instrument setting comparison on/off (p. 56)
<b>PROBE CHECK</b>	Turn probe short-circuit detection on/off (p. 54)
<b>RETRY</b>	Retry function setting (p. 59)
<b>TRIG EDGE</b>	(External I/O) Set trigger rising/falling edge (p. 98)
<b>EOM</b>	(External I/O) Set $\overline{\text{EOM}}$ (end-of-measurement) signal (p. 97)
<b>INTERFACE</b>	Communications interface settings (p. 105)
<b>100m<math>\Omega</math> CURR</b>	100 m $\Omega$ range measurement current settings 100 mA/1 A (p. 28)
<b>CALIBRATION</b>	Self-calibration operation settings (p. 60)
<b>JUDGE BEEP</b>	Comparator beeper settings (p. 66)
<b>KEY BEEP</b>	Key beeper on/off (p. 65)
<b>CLOCK (Y-M-D)</b>	Set internal clock (p. 68)
<b>LINE FREQ</b>	Set power source frequency (p. 67)
<b>CONTRAST</b>	Adjust screen contrast (p. 69)
<b>BACKLIGHT</b>	Adjust screen backlight (p. 70)
<b>RESET</b>	Initialize (p. 71)
<b>ADJUST</b>	Instrument Adjustment (p. A16)

# Measurement Preparations

## Chapter 2

2

Be sure to read the "Operating Precautions" (p.7) before installing and connecting this instrument. Refer to "Appendix 5 Rack Mounting" (p. A11) for rack mounting.

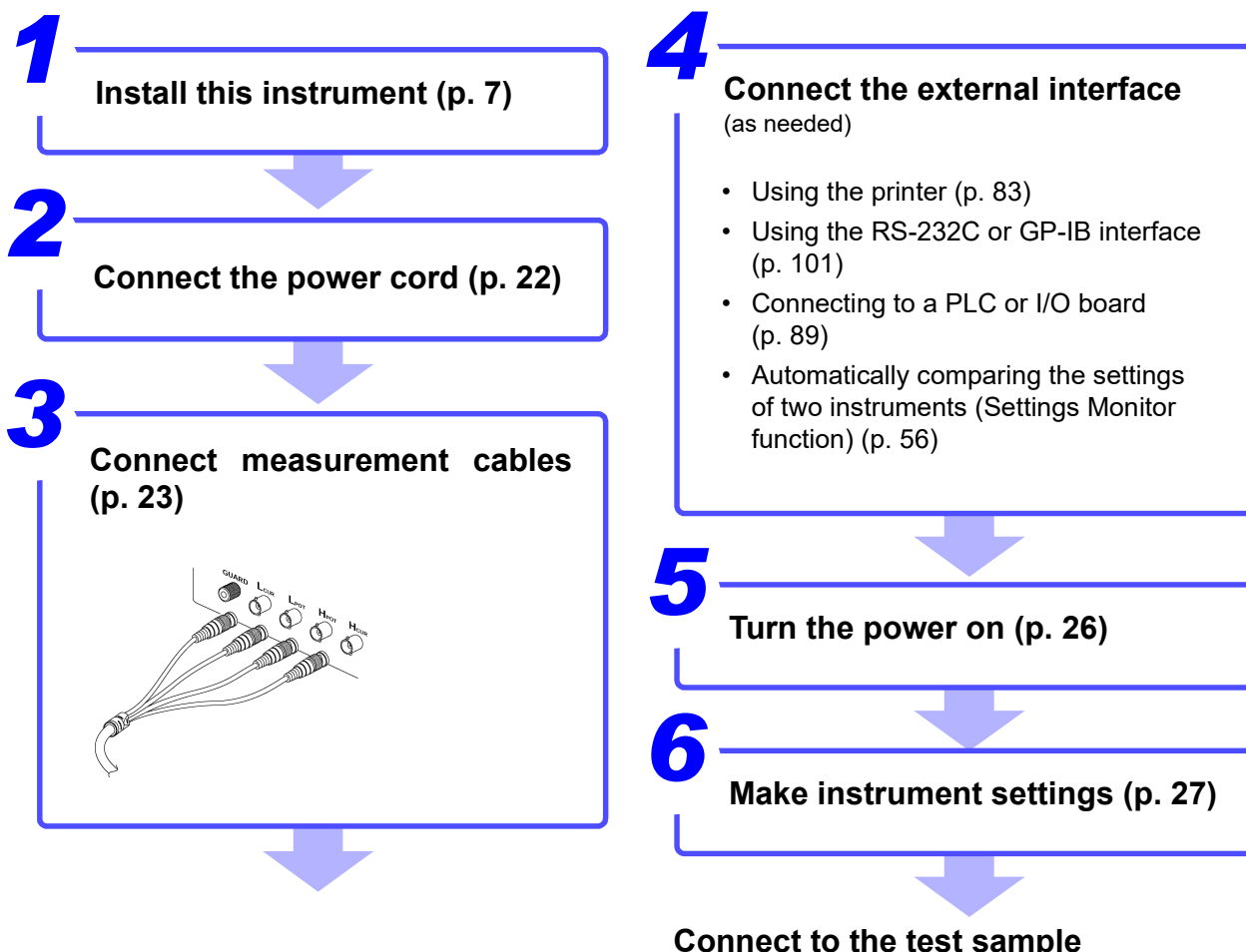
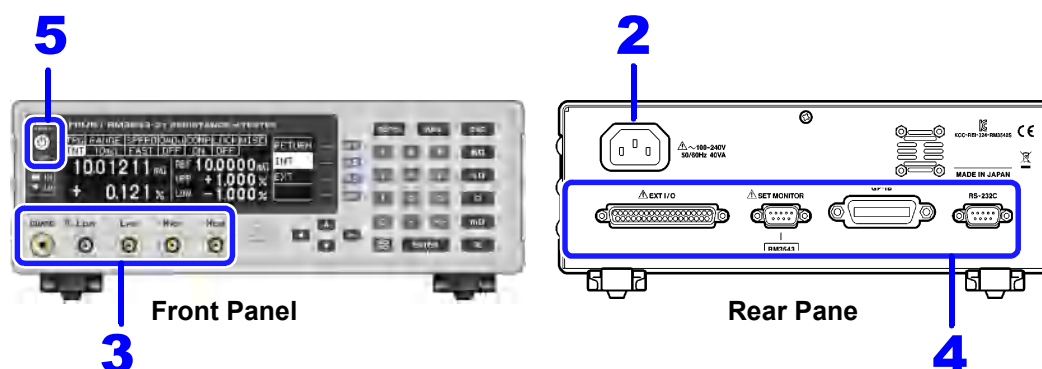

When finished measuring, turn the power off (p. 26).

## 2.1 Connecting the Power Cord



### **! WARNING**

- Before turning the instrument on, make sure the supply voltage matches that indicated on its power connector. Connection to an improper supply voltage may damage the instrument and present an electrical hazard.
- To avoid electrical accidents and to maintain the safety specifications of this instrument, connect the power cord only to a 3-contact (two-conductor + ground) outlet.
- Before using the instrument, make sure that the insulation on the power cord is undamaged and that no bare conductors are improperly exposed. Any damage could cause electric shock, so contact your dealer or Hioki representative.

### **! CAUTION**

To avoid damaging the power cord, grasp the plug, not the cord, when unplugging it from the power outlet.

Power inlet

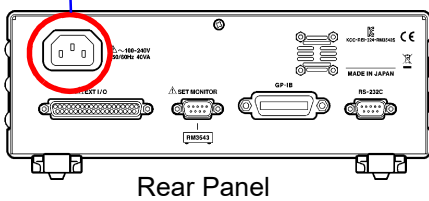

Rear Panel

- 1 Confirm that the mains supply voltage matches the instrument, and connect the power cord to the power inlet on the instrument.

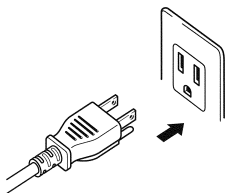

- 2 Plug the power cord into the mains outlet.

The **POWER** button on the front panel lights red.

In event of a power outage, operation resumes with the same settings when power is restored (breaker reset, etc.).

## 2.2 Connecting Measurement Cables and Test Fixtures



Connect your measurement cables, optional Hioki probes or test fixture to the measurement jacks. Refer to "Options" (p.4) for details. See the instructions provided with the fixture for operating details.

2

### CAUTION

- Do not apply a voltage to the measurement terminals. Doing so may damage the unit.
- When disconnecting the BNC connector, be sure to release the lock before pulling off the connector. Forcibly pulling the connector without releasing the lock, or pulling on the cable, can damage the connector.

### NOTE

- We recommend using optional Hioki fixtures.
- Use the GUARD jack only for Faraday shield, and avoid more than 10 mA current flow. This jack is not for guarding network resistance measurements.

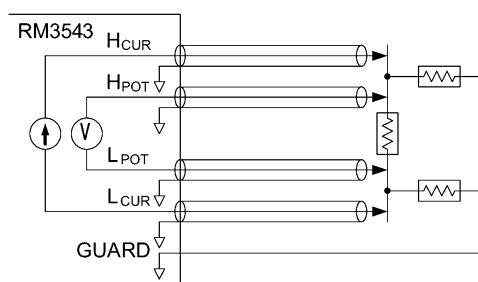

Example of defeated guard measurement

### Connection Methods



#### Connecting measurement cables

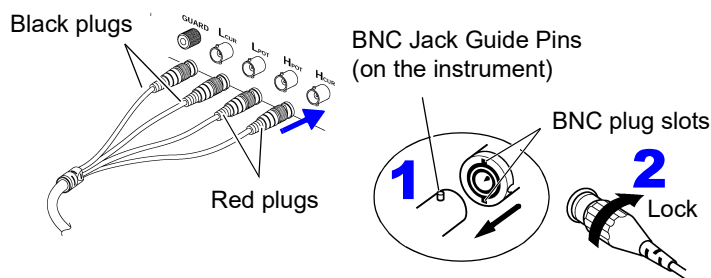

Connect the red plugs to the H<sub>CUR</sub> and H<sub>POT</sub> jacks, and the black plugs to the L<sub>CUR</sub> and L<sub>POT</sub> jacks.

Align the slots in the BNC plug with the guide pins on the jack on the instrument, then push and twist the plug clockwise until it locks.

Disconnecting BNC connectors  
Push the BNC plug, twist it counterclockwise, and pull it out.

#### Connecting a fixture

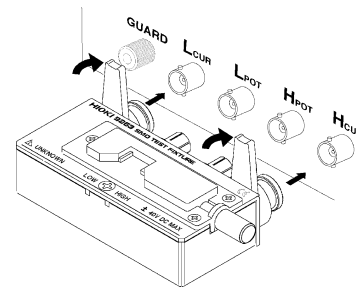

Connect directly to the measurement jacks with the label side up, and affix with the levers on the left and right.

Making your own probes and extenders (p. 24)

### Making Your Own Measurement Cables

#### Recommended Measurement Cable Specifications

<b>Conductor resistance</b>	500 mΩ/m or less
<b>Capacitance</b>	150 pF/m or less
<b>Cable dielectric material</b>	Polyethylene (PE), Teflon* (TFE), polyethylene foam (PEF) Insulation resistance at least 10 GΩ
<b>Connector insulating material</b>	Teflon* (TFE), polybutylene terephthalate (PBT) Insulation resistance at least 10 GΩ
<b>Length</b>	2 m or less

Example: JIS standard 3C-2V, 1.5D-2V MIL standard RG-58A/U

\* Teflon is a registered trademark of E. I. du Pont de Nemours and Company.

Wiring Diagram

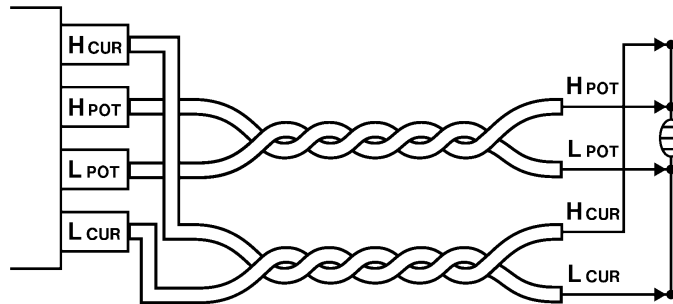

#### Before Wiring

See: "Appendix 3 Unstable Measurement Values" (p. A3)

- Twist together the H<sub>POT</sub> and L<sub>POT</sub> wires, and the H<sub>CUR</sub> and L<sub>CUR</sub> wires. If not twisted together, measured values may be unstable, and errors may occur, when measuring with low resistance values.
- The phenomenon of induction becomes pronounced in the 10 mΩ and 100 mΩ ranges (when the measurement current is set to 1 A). Changes in the cable position and configuration may cause measured values to vary. Exercise particular care so that the cable position and configuration do not change. Additionally, measurement cables and measurement targets should be kept as far as possible from metallic objects.
- When using two or more RM3543 units, do not group the wires from multiple instruments together. The "C.E. Volt" error display may be triggered by the phenomenon of induction.
- Refer to the block diagram (p. 14) for internal circuit details.
- Probes and measurement objects should be shielded at BNC or GUARD jack potential.
- Wiring resistance in excess of the following values may cause a current monitor error, making measurement impossible. When using measurement current 1 A ranges, keep the wiring resistance as well as the contact resistance between the DUT and probe low.

Range	10mΩ	100mΩ	100mΩ	1000mΩ	10Ω	100Ω	1000Ω
Measurement Current	1 A	1 A	100 mA	100 mA	10 mA	10 mA	1 mA
Between H <sub>CUR</sub> and DUT	1 Ω	1 Ω	18 Ω	18 Ω	180 Ω	180 Ω	1.8 kΩ
Between L <sub>CUR</sub> and DUT	1 Ω	1 Ω	8 Ω	8 Ω	80 Ω	80 Ω	800 Ω

**Extending Measurement Cables**

Observe the following when extending measurement cables:

- Measurement cable length should not exceed 2 m (with conductor resistance 500 m $\Omega$ /m or less). Long cables are more susceptible to noise, and measured values may be unstable.
- Extensions should maintain the four-terminal structure. If converted to a two-terminal circuit in the wiring, correct measurement may not be possible due to the effects of wiring and contact resistance.
- Cables and measurement objects should be shielded.
- After extending measurement cables, confirm operation and accuracy ("Measurement Specifications" (p.180)).
- If cutting the ends off of optional measurement cables, make sure that the shield does not touch the center conductor of the H<sub>CUR</sub>, H<sub>POT</sub>, L<sub>POT</sub> and L<sub>CUR</sub> cables. Correct measurement is not possible with a shorted cable.
- Do not twist wires from multiple units together.

# 2.3 Turning the Power On and Off

## Turning Power On

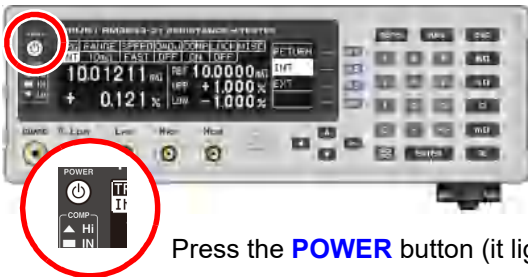

Press the **POWER** button (it lights green).

### After Power-On

A self-test (instrument diagnostic routine) is performed. During the self-test, the following information is displayed while the hardware is verified.

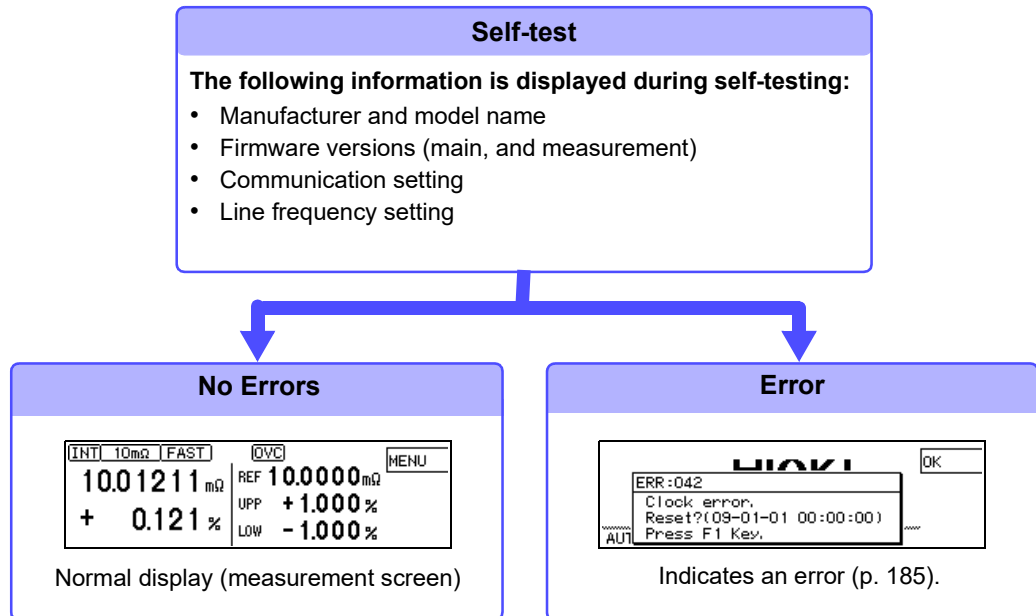

When the power is turned on, the same setting as when the power was last turned off appears (backup function).

When powered up for the first time, the default settings appear.

See: "Default Settings" (p.72)

### Before Starting Measurement

To obtain precise measurements, provide about 30 minutes warm-up after turning power on. Measurement settings are recalled from when the power was previously turned off (settings backup).

However, measurement settings made through the RS-232C or GP-IB interface are not retained, although they can be stored using the `:SYSTEM:BACKUp` command (p. 139).

## Turning Power Off

Press the **POWER** button (it lights red when the instrument is off).

Disconnect the power cord from the outlet to extinguish the **POWER** button light.

When power is turned on again, operation resumes with the same settings as when last turned off.

### NOTE

If a power outage (e.g., breaker trip) occurs when the instrument is on, it will automatically turn on again when power is restored (without pressing the **POWER** button).



# Measurement Settings (Basic Measurements)

## Chapter 3

3

See "Measurement Flow" (p. 2) for an outline of the measurement process from preparation to end-of-measurement.

### 3.1 Pre-Operation Inspection

Before using the instrument for the first time, verify that it operates normally to ensure that no damage occurred during storage or shipping. If you find any damage, contact your dealer or Hioki representative.

#### 1 Peripheral Device Inspection

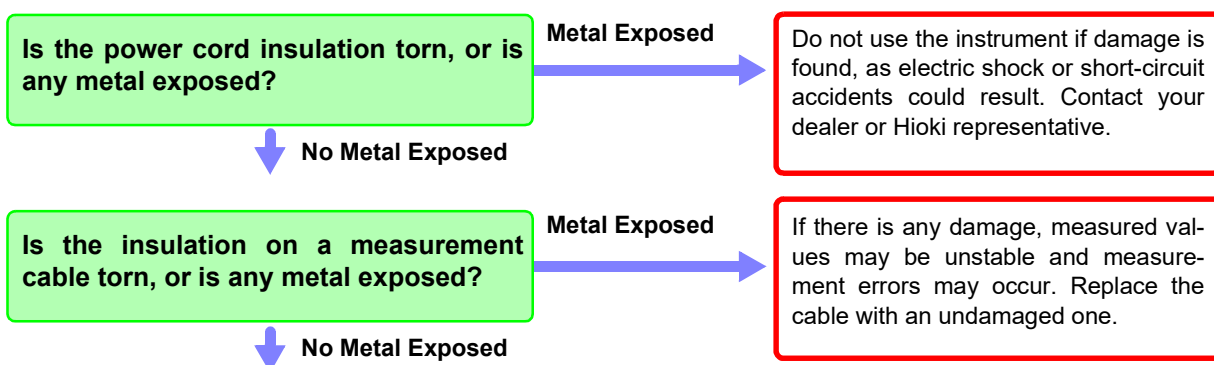

#### 2 Instrument Inspection

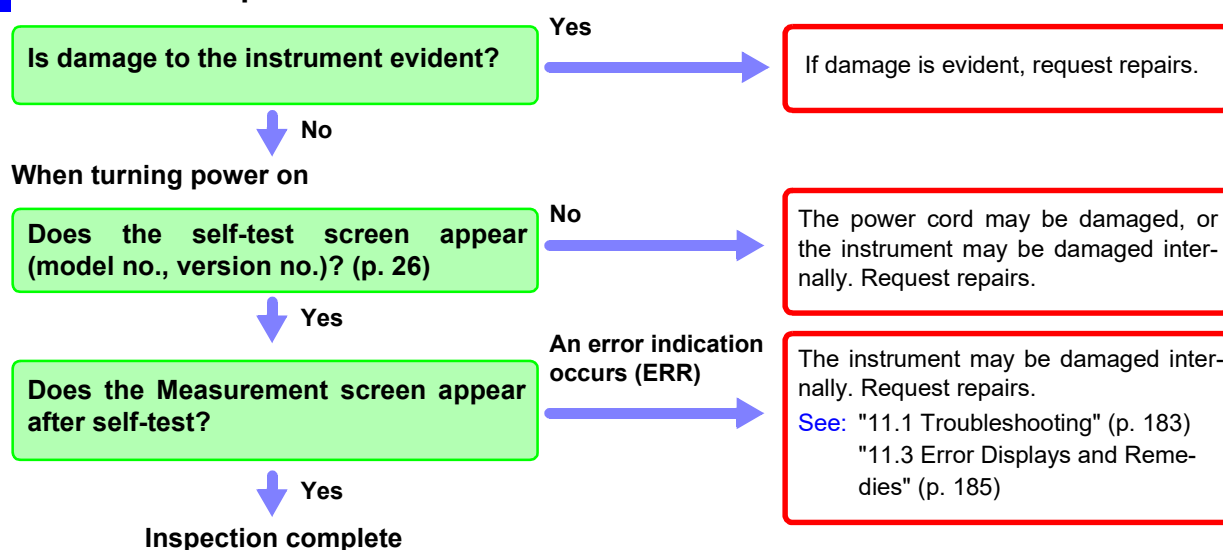

Please read the "Operating Precautions" (p. 7) before use.

# 3.2 Switching 100 mΩ range Measurement Currents

The 100 mΩ range measurement current can be switched between 100 mA and 1 A. The 100 mA setting (which is the factory default) allows measurement at a high level of precision. The 1 A setting can be used to provide better resistance to external noise.

See: "(5) DUT Becomes Warm" (p. A6)

(Example) If the resistance to be measured is 100 mΩ

(Measurement Current)

100 mA	$100\text{ m} \times 0.1^2 = 1\text{ mW}$
1 A	$100\text{ m} \times 1^2 = 100\text{ mW}$

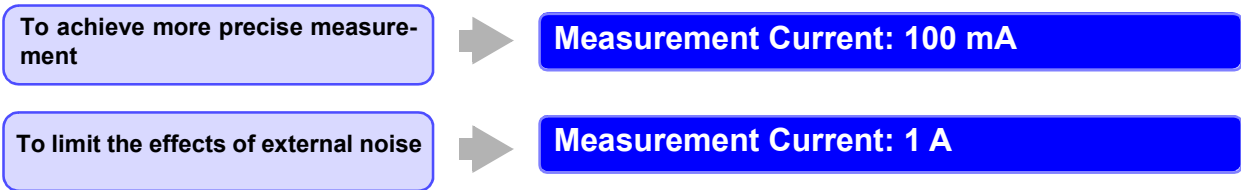

## 1 Open the Basic Settings screen.



## 2 Open the System screen.

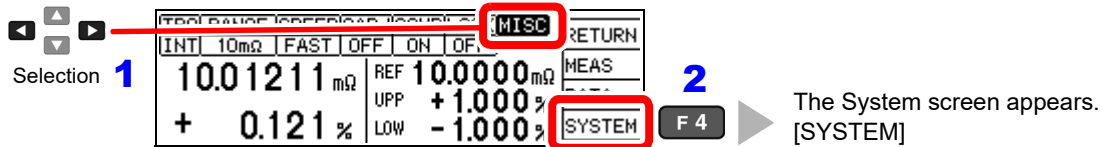

## 3 Select the 100 mΩ range measurement current.

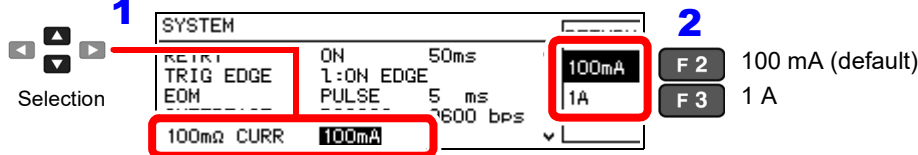

## 4 Return to the Measurement screen.

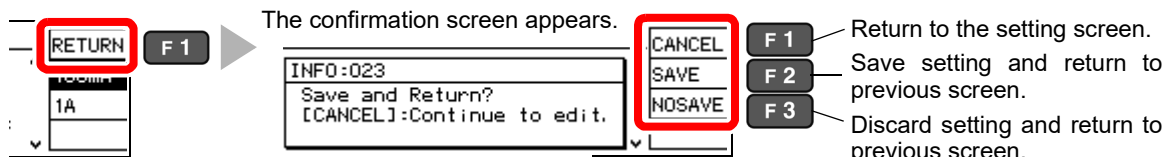

### NOTE

- The 100 mΩ range measurement condition settings are configured separately for each measurement current. Consequently, the 100 mΩ range measurement condition settings should be configured after first setting the measurement current.
- During measurement, a transient current equal to about 1.5 times the steady-state current will flow for several microseconds (or about 10 mApk in the 1 kΩ range). Exercise special care when measuring targets whose characteristics are prone to vary.

## 3.3 Setting the Measurement Speed

The measurement speed can be set to FAST, MED (medium), or SLOW. A slower measurement speed provides greater measurement precision, and a faster measurement speed results in greater susceptibility to environmental noise. Ensure that measurement cables and the sample are sufficiently shielded.

### NOTE

The averaging function can be used to further stabilize measured values. (p. 48)

### 1 Open the Basic Settings screen.

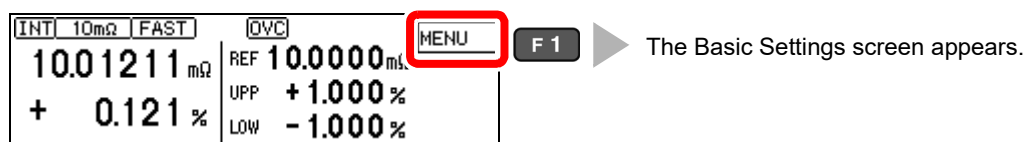

### 2 Select the measurement speed.

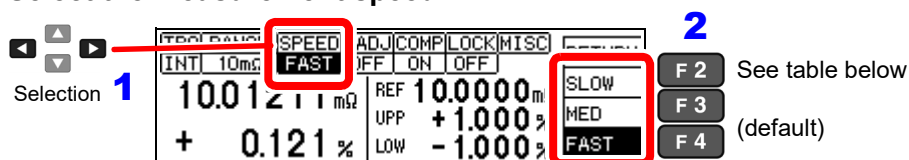

### 3 Return to the Measurement screen.

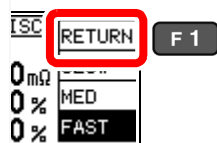

## Relationship Between Measurement Range and Speed

(factory defaults)

Measurement Range	FAST	MED	SLOW
10mΩ Average: 16 times *1	176 ms	272 ms	752 ms 640 ms
10mΩ	11 ms	17 ms	47 ms 40 ms
100mΩ (1A)	5.0 ms	13 ms	43 ms 36 ms
100mΩ (100mA)	3.8 ms	13 ms	43 ms 36 ms
1000mΩ	2.0 ms	6.4 ms	41 ms 35 ms
10Ω	1.6 ms	6.0 ms	41 ms 34 ms
100Ω	1.6 ms	4.0 ms	41 ms 34 ms
1000Ω	1.6 ms	4.0 ms	41 ms 34 ms

Integration time can be optionally set for each range (p. 46).

Upper value: for 50-Hz power line frequency

Lower value: for 60-Hz power line frequency

Tolerance:  $\pm 10\% \pm 0.2$  ms

(Without retry)

\*1 When performing external trigger measurement.

When performing internal trigger measurement, same as when averaging is off.

# 3.4 Setting Measurement Start Conditions (Trigger Source)

Measurements can be started in two ways.

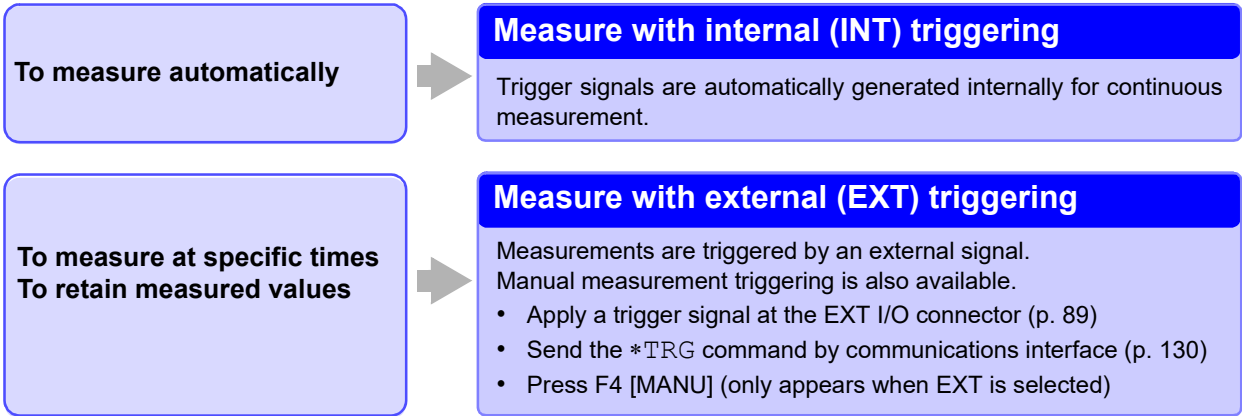

**NOTE**

- When internal triggering is enabled, the EXT I/O TRIG signal and the “\*TRG” command are ignored (except for memory storage and statistical calculations).
- When using the internal trigger, the delay time (DELAY1) is obtained by adding 100 ms to the setting (to prevent heat generation).
- To measure samples such as inductors that require time to settle, adjust delay time DELAY2. Start with a long delay, and gradually shorten it while watching for the measured value to settle.  
 See: "4.2 Setting Pre-Measurement Delay" (p. 42)
- When external triggering is enabled, the Auto-Memory function is disabled by force.

**1 Open the Basic Settings screen.**

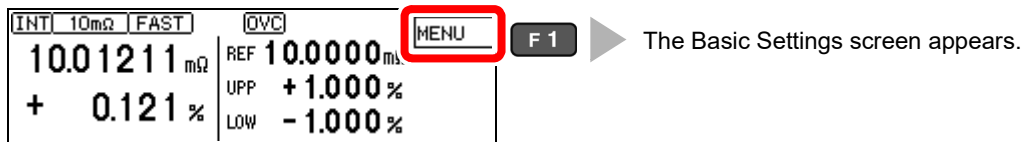

**2 Select internal (INT) or external (EXT) triggering.**

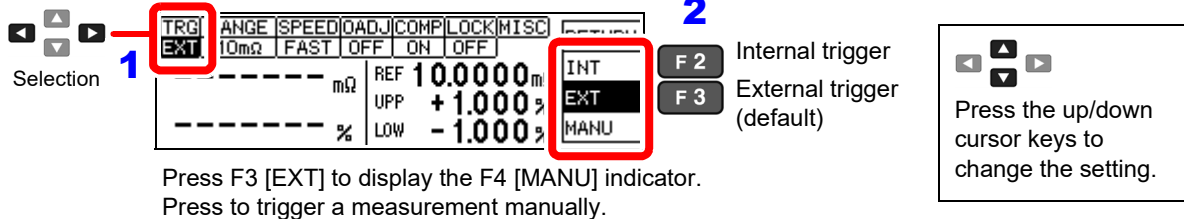

**3 Return to the Measurement screen.**



Continuous measurement (: INITIATE : CONTINUOUS ON) is the normal trigger state when operating from the front panel. Selecting the internal (INT) trigger source activates continuous triggering ("free-run"). When external (EXT) triggering is selected, each external trigger event initiates one measurement. Continuous measurement can be disabled by sending the : INITIATE : CONTINUOUS OFF command via RS-232C or GP-IB. When continuous measurement is disabled, trigger acceptance is controlled only by the host (computer or PLC).

See: for trigger command: "Triggering" (p. 142), "9.8 Data Exporting Methods" (p. 152)

## 3.5 Selecting the Measurement Range

The measurement range can be set as follows. When making comparator settings with the panel keys, the measurement range is selected automatically according to the settings (reference/tolerance or upper/lower thresholds, see the following table). When the comparator settings are made by remote control commands, the measurement range is unaffected.

### Changing the Range

Measurement error is larger when measuring values nearer the bottom of a measurement range.

### Auto-Ranging (when making comparator settings)

Reference (REF%) and Upper/Lower Threshold (ABS) Ranges	Selected Range
0 to 10.009 mΩ	10 mΩ
10.01 to 100.09 mΩ	100 mΩ
100.1 to 1000.9 mΩ	1000 mΩ
1.001 to 10.009 Ω	10 Ω
10.01 to 100.09 Ω	100 Ω
100.1 to 1200.0 Ω	1000 Ω

### Manual Range Selection

**1** Open the Basic Settings screen.



**2** Select the range.

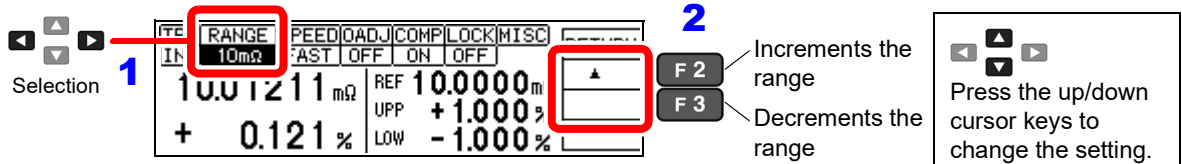

- 10mΩ, 100mΩ, 1000mΩ, 10Ω, 100Ω, 1000Ω (default)

**3** Return to the Measurement screen.

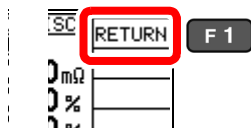

### NOTE

- The measurement range is automatically selected when using the comparator function, but an OvrRng error may occur when the scaling function is on. If this occurs, set an appropriate range manually. For example, the 1,000 mΩ range will be selected under the following conditions, but the measurement target of 2 Ω will result in an OvrRng error:
  - Measurement target: 2 Ω
  - Scaling compensation coefficient: 0.5
  - Displayed measured value: 1 Ω
  - Comparator reference value: 1 Ω
- During measurement, a transient current equal to about 1.5 times the steady-state current will flow for several microseconds (or about 10 mA<sub>pk</sub> in the 1 kΩ range). Exercise special care when measuring targets whose characteristics are prone to vary.

## 3.6 Zero Adjustment

When four-terminal measurement (Kelvin connection) is impractical such as when measuring very small samples, the additional inherent resistance of the two-terminal wiring should be canceled out. The zero-adjustment function can cancel out up to 10 Ω additional resistance.

**NOTE**

**Before Zero Adjustment**

- The guaranteed accuracy of the instrument applies to four-terminal connections without zero adjustment. When using four-terminal connections, do not execute zero adjustment. Executing zero adjustment with incorrect wiring may amplify measurement error. However, zero adjustment may be needed even with four-terminal measurements if they are affected by a large offset voltage, such as due to thermal emf.
- Execute zero adjustment when the ambient temperature has changed, or when a probe is replaced.

Execute zero adjustment after the warm-up period following power on.

**1 Open the Basic Settings screen.**



**2 Select the internal (INT) trigger mode.**

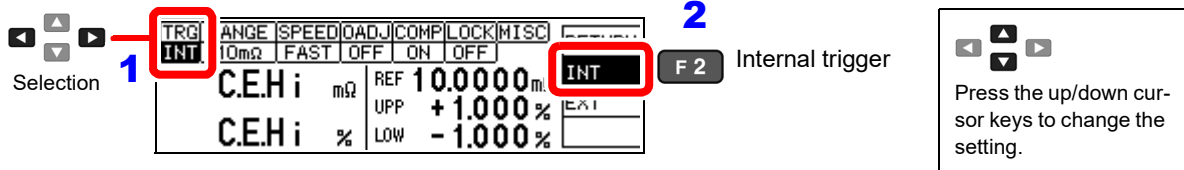

**3 Short the probes together.**



**4 Confirm that the measured value does not exceed 10 Ω.**

If no measured value is displayed, increment the measurement range (p. 31).

**5 Select whether to enable or disable zero adjustment.**

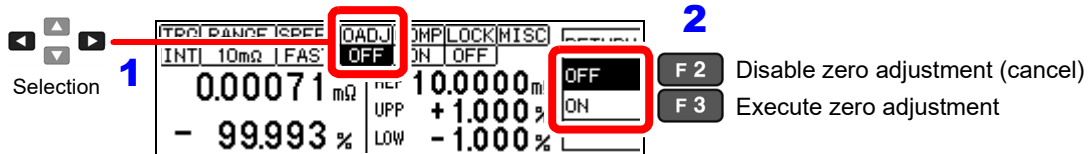

After confirming that the measured value does not exceed 10 Ω, execute zero adjustment.

**6 Return to the Measurement screen.**

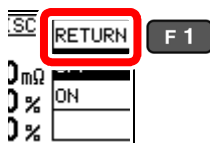

## Zero Adjustment Faults

If zero adjustment fails, the following error message appears.

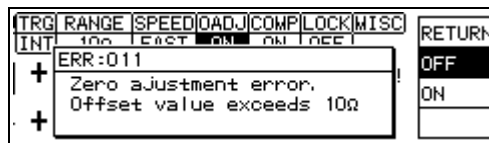

Before attempting zero adjustment again, confirm the following:

- With the 10 Ω range selected, confirm that the displayed value does not exceed 10 Ω.
- Confirm that the probe connections are correct.

### NOTE

When the scaling calculation function is on, you may be unable to zero out the measured value, even if you perform zero adjustment (because the zero-adjusted measured value is still subject to scaling calculation).

# 3.7 Judging Measured Values (Comparator Function)

Comparator results are available as external output (at the EXT I/O connector) when the comparator reference/tolerance or upper/lower threshold values have been set.

See: "Chapter 8 External Control" (p. 89)

Comparator results are also indicated by the COMP Hi/IN/Lo panel lamps, and by audible beeper (disabled by default).

See: "Setting the Comparator Decision ("JUDGE") Beeper" (p. 66)

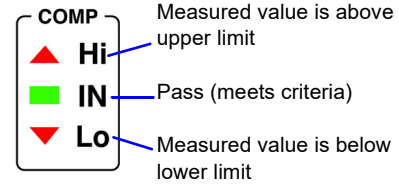

The comparator decision mode can be set as one of the following:

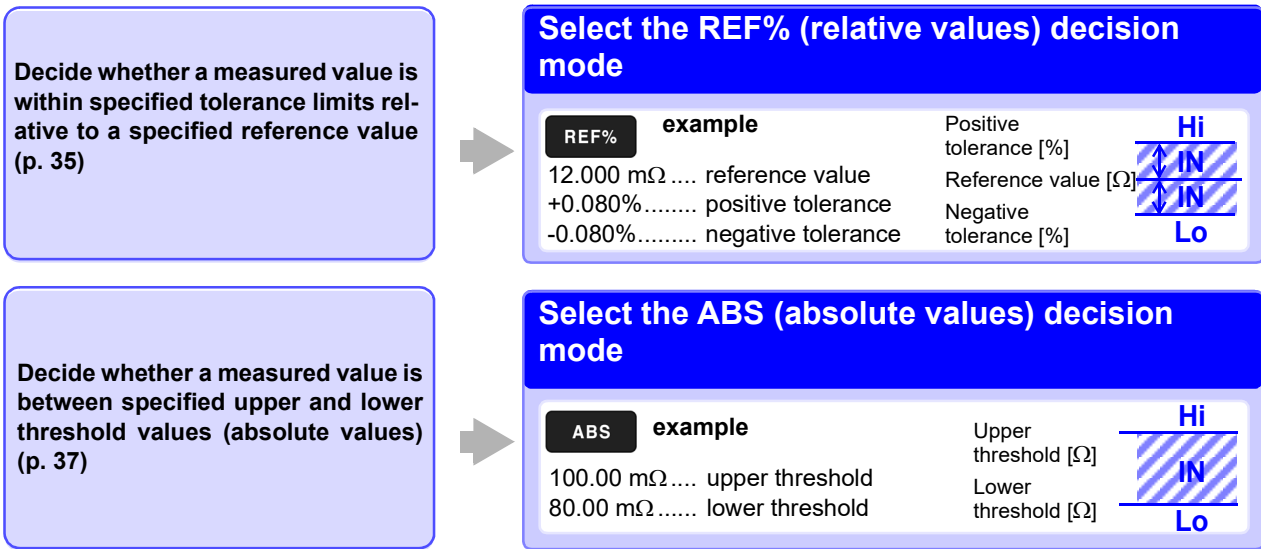

## Before Using the Comparator Function

- When the measured value is out of the selected measurement range, comparator decision indicators appear as follows. In the event of a measurement fault, no decision is made.

See: "3.8 Confirming Faulty Measurements" (p. 38)

Out-of-Range Display	Comparator Decision Indicator
+OvrRng	Hi
-OvrRng	Lo

- If power is turned off during comparator setting, changes to settings are lost as they revert to their previous values. To accept the settings, press the **ENTER** key.
- When setting comparator criteria, the appropriate range is selected automatically. Refer to "Auto-Ranging (when making comparator settings)" (p. 31) for range settings.



**Enabling and Disabling the Comparator Function**

The comparator function is enabled by default.  
When the function is disabled, comparator settings are ignored.

**1** Open the Basic Settings screen.



**2** Enable or disable the comparator function.

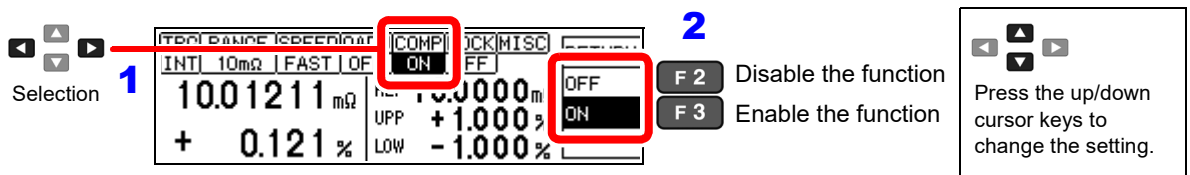

**3** Return to the Measurement screen.

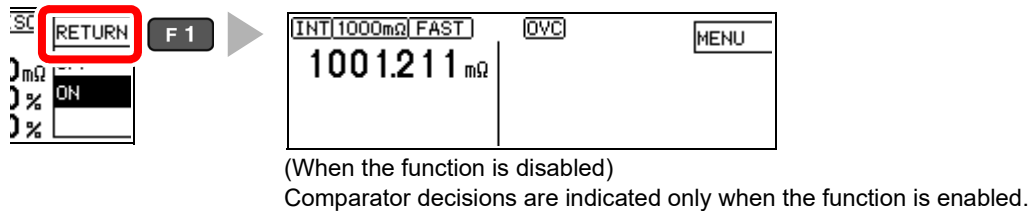

**Decide According to Reference Value and Tolerance (REF% Mode)**

$$\text{Relative Value (tolerance)} = \left( \frac{\text{Measured Value}}{\text{Reference Value}} - 1 \right) \times 100 [\%]$$

Setting range:  
-9.999% to +9.999% (When 10% or less)  
-99.99% to +99.99% (When more than 10%)

Example: Set a reference value of 10.5 μΩ with ±4.5% decision tolerance.

To abort the setting process, press **ESC**. Settings are abandoned and the display returns to the previous screen.

**1** Open the relative tolerance setting screen.

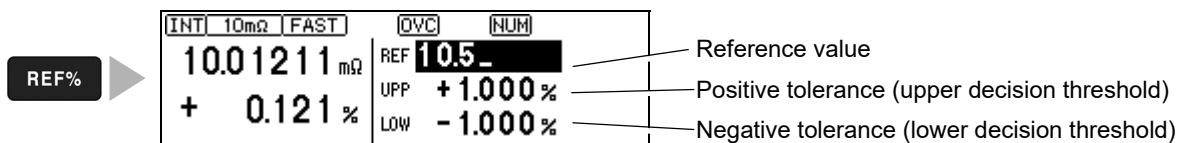

3.7 Judging Measured Values (Comparator Function)

**2** Set the reference value.

Pressing an inoperative key during setting sounds a low-pitch beep (when the key beeper is enabled).

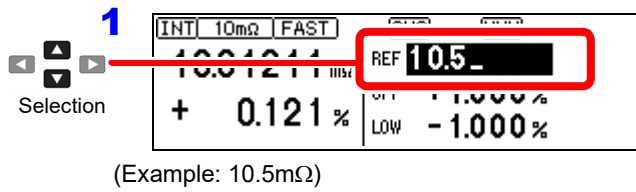

(Example: 10.5mΩ)

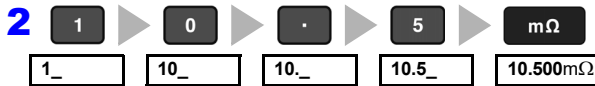

**To Reset Numerical Values**

**BACK** Deletes entered digits.  
**SPACE** This key is enabled only when entering numerical values.

To change the value after selecting the units, use the cursor ▲▼ keys to select the item to change, then enter the new value with the tenkeys.

Press the units key to accept the setting and move the cursor to the positive tolerance.

**3** Set the positive tolerance.

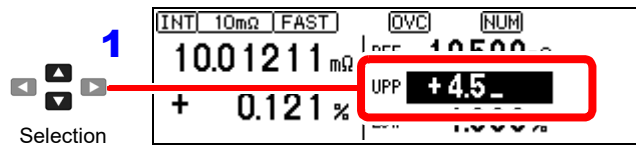

(Example: 4.5%)

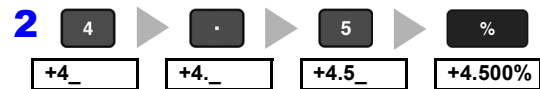

**To Reset Numerical Values**

**BACK** Deletes entered digits.  
**SPACE** This key is enabled only when entering numerical values.

To change the value after selecting the units, use the cursor ▲▼ keys to select the item to change, then enter the new value with the tenkeys.

**To Set a Negative Value**

**+/-** Press this key to change the sign, as needed.

Press the % key to accept the setting and move the cursor to the negative tolerance value. The negative tolerance is initially set to the same amplitude as the positive tolerance (change as needed).

**4** Set the negative tolerance in the same way (as needed).

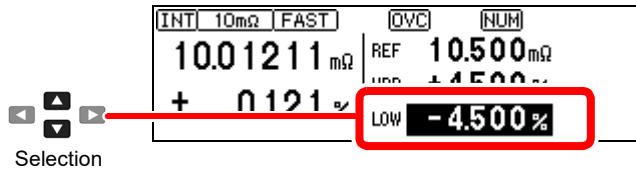

**5** Accept the settings and return to the Measurement screen.

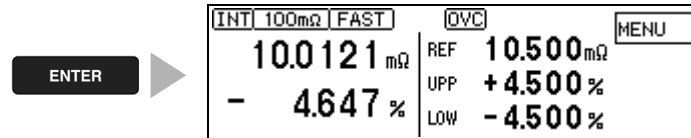

**NOTE**

- Internal calculations are performed on floating-point values, and decisions round up any fraction of the least-significant digit.
- Displayed values of the reference and tolerances are rounded according to the selected range. Internal calculations use unrounded data, so decisions are based on the entered (setting) values.
- An error message appears if you press **ENTER** with the positive tolerance set lower than the negative tolerance.

See: "11.3 Error Displays and Remedies" (p. 185) (ERR:001)

## Decide According to Upper/Lower Thresholds (ABS Mode)

Setting example: Upper threshold 150 mΩ, lower threshold 50 mΩ

To abort the setting process, press **ESC**. Settings are abandoned and the display returns to the previous screen.

### 1 Open the absolute value threshold setting screen.

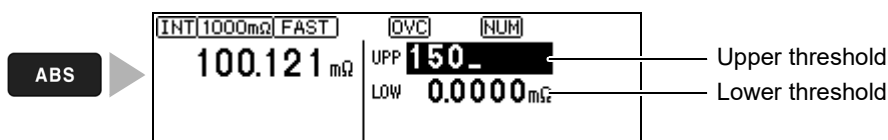

### 2 Set the positive tolerance.

Pressing an inoperative key during setting sounds a low-pitch beep (when the key beeper is enabled). No error message is displayed.

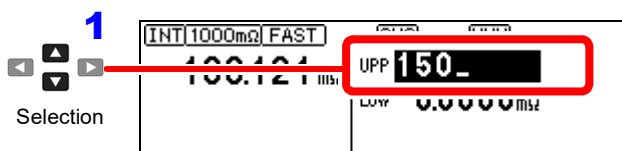

(Example: 150 mΩ)



#### To Reset Numerical Values

**BACK SPACE** Deletes entered digits. This key is enabled only when entering numerical values.

To change the value after selecting the units, use the cursor **▲▼** keys to select the item to change, then enter the new value with the tenkeys.

Press the units key to accept the setting and move the cursor to the lower threshold value.

### 3 Set the negative tolerance in the same way.

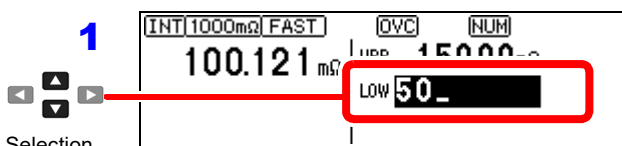

(Example: 50 mΩ)

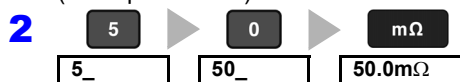

Press the units key to accept the setting and move the cursor to the upper threshold.

### 4 Accept the settings and return to the Measurement screen.

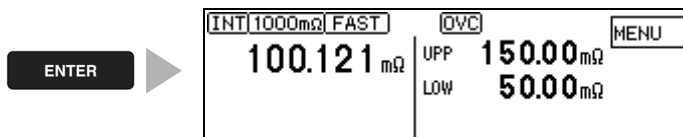

#### NOTE

- Internal calculations are performed on floating-point values, and decisions round up any fraction of the least-significant digit.
- Displayed values of the reference and tolerances are rounded according to the selected range. Internal calculations use unrounded data, so decisions are based on the entered (setting) values.
- An error message appears if you press **ENTER** with the positive tolerance set lower than the negative tolerance.

See: "11.3 Error Displays and Remedies" (p. 185) (ERR:001)

## 3.8 Confirming Faulty Measurements

When a measurement is not performed correctly, a measurement fault indicator appears and a measurement fault signal is output at the ERR pin of the EXT I/O connector (except for out-of-range detection).

The instrument detects measurement faults by the following four methods.

### Out-of-Range

See: "Out-of-Range Detection Function" (p. 39)

Display  
+OvrRng  
-OvrRng

Appears when the measured value is outside of the measurement or display range. Check for a broken sample component. The comparator result is Hi when +OvrRng is displayed, and Lo when -OvrRng is displayed. No external measurement fault signal (ERR) is output.

### Contact Check Fault

See: "4.6 Checking for Poor or Improper Contact (Contact Check Function)" (p. 49)

Display  
C.E. Hi  
C.E. Lo

The resistance between the H<sub>POT</sub> and H<sub>CUR</sub> probe contacts, and between the L<sub>POT</sub> and L<sub>CUR</sub> probe contacts, are measured and compared with specified contact fault values. An error message appears when the measured value reaches or exceeds the specified contact fault values. If this error persists, probe wear or cable failure may be the cause. If the error is not cleared by shorting the tips of a known-good measurement cable, the instrument requires repair.

### Voltage Level Monitor Fault

See: "4.8 Detecting Measurement Voltage Faults (Voltage Level Monitor Function)" (p. 52)

Display  
C.E. Volt

This method monitors the stability of the voltage between H<sub>POT</sub> and L<sub>POT</sub> probe contacts. An error message appears when voltage instability is detected due to chattering of the probe contacts. If this error persists, the probes may be degraded due to wear. C.E. Volt may also be displayed when external noise is strong.

### Current Monitor Fault

See: "Current Monitor Function" (p. 39)

This method monitors the regulated measurement current for normal flow through the DUT. An error is detected mainly when a measurement fault occurs due to an open-circuit DUT or between the H<sub>CUR</sub> and L<sub>CUR</sub> probe's poor contacts. The error display depends on the contact check and voltage level monitor states (see the table below).

.....

This display appears after changing measurement settings and before the next measurement is performed.

### Display Examples: Display Measurement State and Appearance with Open-Circuit Probe

Display Measurement State		Current Monitor Results	
		Normal (PASS)	Fault (FAIL)
Contact Check Results	Normal (PASS)	Display: Measured Value COMP indicator: According to the measured value	Display: +OvrRng COMP indicator: Hi (when connection to the measurement object is broken)
Voltage Level Monitor Results	Fault (FAIL)	Display: C.E. Hi/ C.E. Lo/ C.E. Volt COMP indicator: No decision EXT I/O: ERR signal output	Display: C.E. Hi/ C.E. Lo/ C.E. Volt COMP indicator: No decision EXT I/O: ERR signal output

The measurement fault display differs according to detection order and settings.

### Measurement Fault Detection Order

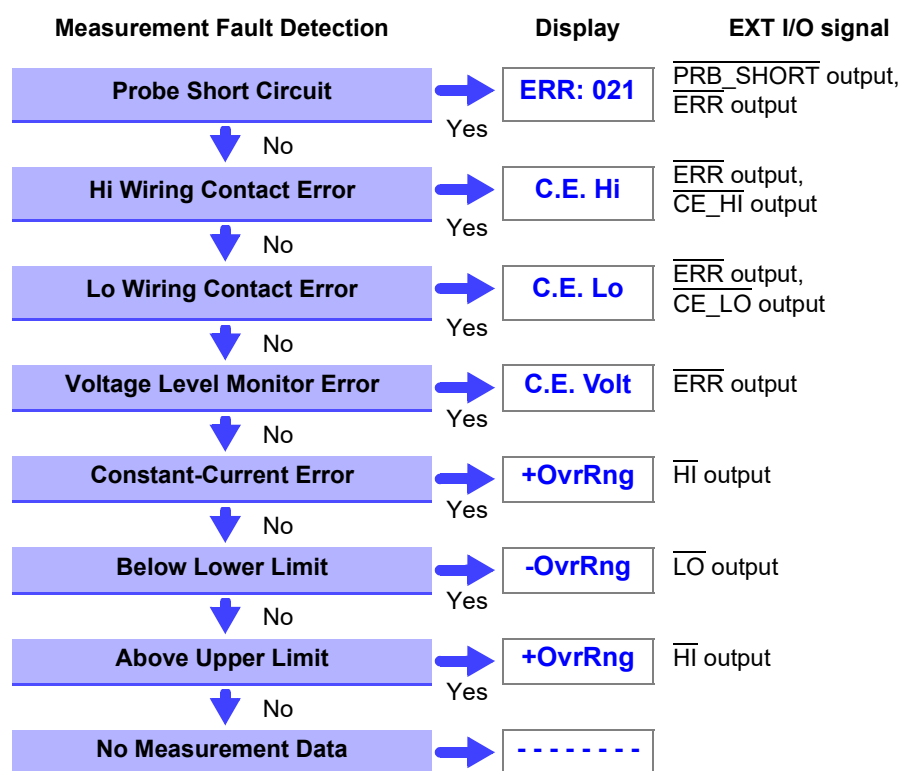

#### NOTE

Measurement fault detection proceeds in the order shown at the left, ending with display of the first detected error.

Corresponding measurement fault signals are also output at the EXT I/O connector.

3

### Out-of-Range Detection Function

#### Examples of Out-of-Range Faults

Out-of-Range Detection	Measurement Example
The measured value is outside of the measurement range.	Attempting to measure 13 $\Omega$ with the 10 $\Omega$ range selected
The relative tolerance (%) display of the measured value exceeds the display range (999.999%).	Measuring 500 $\Omega$ (+2400%) with a reference value of 20 $\Omega$
The zero-adjusted value is outside of the display range.	In the 1000 m $\Omega$ range with 0.5 $\Omega$ zero-adjustment in effect, measuring 0.1 $\Omega$ provides a zero-adjusted value of -0.4 $\Omega$ , which is outside of the display range.
While measuring, input voltage exceed the A/D converter input range.	Measuring a large resistance value in an electrically noisy environment

### Current Monitor Function

- The instrument supplies constant measurement current through the DUT via the  $H_{\text{CUR}}$  and  $L_{\text{CUR}}$  probes. A current monitor fault occurs if constant current cannot be attained. If the contact check and voltage level monitor results are normal, the out-of-range and comparator result displays indicate "Hi".
- Wiring resistance in excess of the following values may cause a current monitor error, making measurement impossible. When using measurement current 1 A ranges, keep the wiring resistance as well as the contact resistance between the DUT and probe low.

Range	10m $\Omega$	100m $\Omega$	100m $\Omega$	1000m $\Omega$	10 $\Omega$	100 $\Omega$	1000 $\Omega$
Measurement Current	1 A	1 A	100 mA	100 mA	10 mA	10 mA	1 mA
Between $H_{\text{CUR}}$ and DUT	1 $\Omega$	1 $\Omega$	18 $\Omega$	18 $\Omega$	180 $\Omega$	180 $\Omega$	1.8 k $\Omega$
Between $L_{\text{CUR}}$ and DUT	1 $\Omega$	1 $\Omega$	8 $\Omega$	8 $\Omega$	80 $\Omega$	80 $\Omega$	800 $\Omega$

#### Example of Current Monitor Fault

- Broken DUT (open work)
- $H_{\text{CUR}}$  or  $L_{\text{CUR}}$  probe contact fault
- $H_{\text{CUR}}$  or  $L_{\text{CUR}}$  cable break



# Customizing Measurement Settings

## Chapter 4

(set as needed)

Change measurement settings as appropriate for your application. Refer to "Detailed Settings Screens" (p. 19) for the available settings.

4

### 4.1 Making Range-Specific Measurement Settings

These settings can be made for each range (except for the DELAY1 setting).

#### 1 Open the Basic Settings screen.

INT	10mΩ	FAST	QVC	MENU	F 1
10.01211 mΩ		REF	10.0000 m		
+ 0.121 %		UPP	+1.000 %		
		LOW	-1.000 %		

The Basic Settings screen appears.

#### 2 Open the Measurement Settings Screen.

Selection	1	INT	10mΩ	FAST	OFF	ON	OFF	MISC	DETAILS	2
		10.01211 mΩ		REF	10.0000 m		MEAS			
		+ 0.121 %		UPP	+1.000 %		DATA			
				LOW	-1.000 %		SYSTEM			

The Measurement Settings Screen appears.  
[MEAS SETTINGS]

#### 3 Select the range to use.

Selection	1	10mΩ	+	F 2	F 3
		DELAY1	0.0 ms	:ALL RANGE	
		DELAY2	0.0 ms		
		SCALING	OFF		
		(A*R+B)	A: 1.00000		
			B: +0.00000mΩ		

2

#### 4 Set the items as needed.

#### NOTE

The 100 mΩ range measurement condition settings are configured separately for each measurement current. Consequently, the 100 mΩ range measurement condition settings should be configured after first setting the measurement current (p. 28).

## 4.2 Setting Pre-Measurement Delay

This setting specifies the delay between trigger signal input and the start of measurement. Adjust this setting to delay measurement until the measured value has time to stabilize, so that even if the sample is connected after triggering, measurement starts only after the specified delay. The delay can be set by two methods, as follows.

Adjust this setting to allow for probe contact mechanical stabilization.

**Set DELAY1**  
 The DELAY1 setting is common to all ranges. The default setting is 0 ms (corresponding to trigger signal input at the same time as probe contacts become stable). Setting DELAY1 affects measurements in all ranges.

Adjust this setting to allow for stabilization of the measurement sample.

**Set DELAY2**  
 Set DELAY2 to the time needed for stabilization after measurement current is applied, such as may be required for inductive components. The setting affects only the selected range. The default setting is 0 ms (corresponding to resistance measurement of non-inductive components).

DELAY1 and DELAY2 Timing Chart

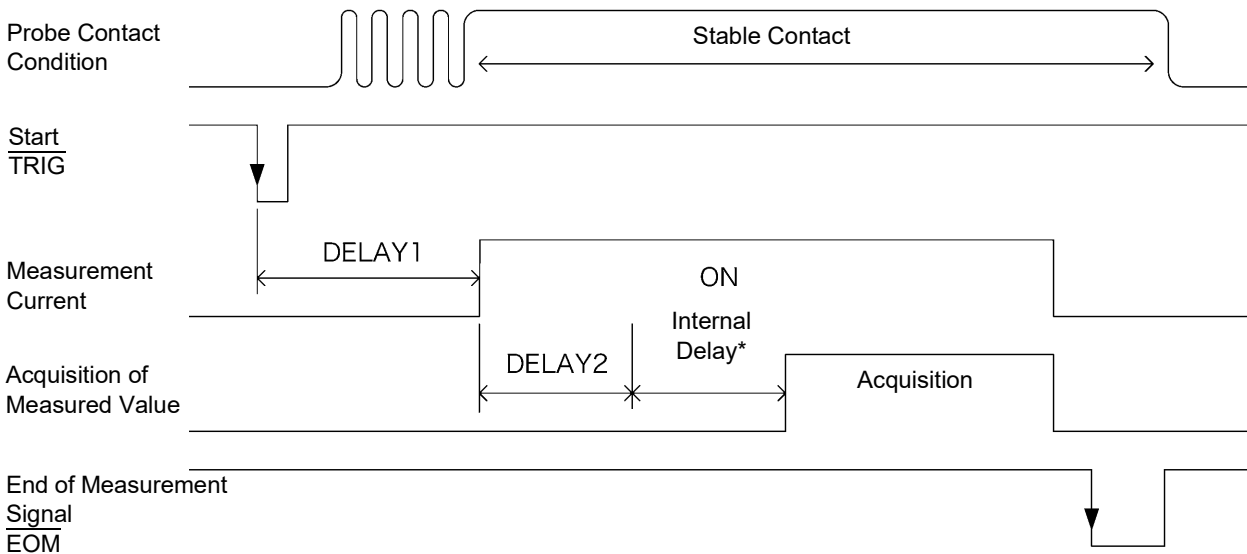

\* Internal delay is provided to suit purely resistive (non-reactive) DUTs, and is different for each measurement range.



## Determining the Delay Time

Set the delay so that inductance does not affect measurements.

To fine tune the delay, begin with a longer delay than necessary, then gradually shorten it while watching the measured value.

### 1 Open the Basic Settings screen.

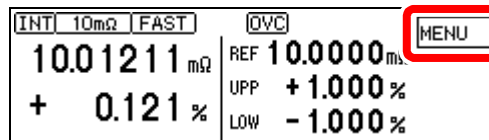

F1 → The Basic Settings screen appears.

### 2 Open the Measurement Settings Screen.

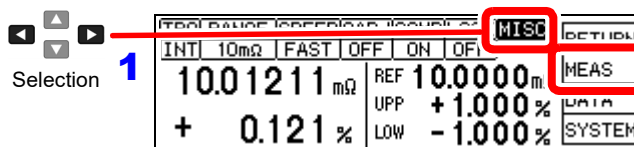

2

F2 → The Measurement Settings Screen appears.  
[MEAS SETTINGS]

### 3 Set DELAY1 or DELAY2.

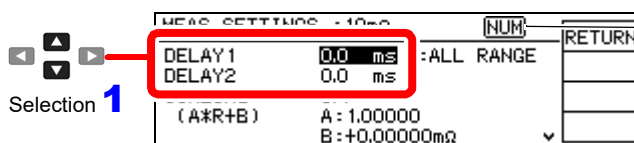

Tenkeys

DELAY1 is common to all ranges, while DELAY2 can be set for each range independently (p. 41).

2 0 ..... 9 / . Setting range: 0.0 ms (default) to 100.0 ms

3 ENTER

### 4 Return to the Measurement screen.

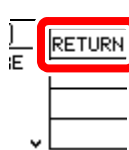

F1

The confirmation screen appears

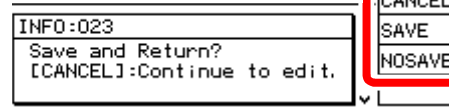

F1

Return to the setting screen.

F2

Save setting and return to previous screen.

F3

Discard setting and return to previous screen.

#### NOTE

When using the internal trigger, the delay time (DELAY1) is obtained by adding 100 ms to the setting (to prevent heat generation).

# 4.3 Correcting Measured Values (Scaling Function)

When measuring the resistance of current sensing resistors, there may be a discrepancy between the resistance value at the time of mounting on the board being used and the resistance value obtained when measuring the component alone (due to the effects of the probing location and other factors). The scaling function corrects the resistance measured value obtained from the component alone to yield the resistance value during actual use. Scaling is performed by means of the following equations:

$$R_s = A \times R + B$$

- R : Measured value before compensation
- R<sub>s</sub> : Resistance value after compensation
- A : Compensation coefficient    Setting range: 0.50000 to 2.00000 (default: 1.00000)
- B : Offset resistance value    Setting range: ±10% of full scale for each range (default: 0 mΩ)

See: "Appendix 4 Effects of Probing" (p. A9)

## 1 Open the Basic Settings screen.



## 2 Open the Measurement Settings Screen.

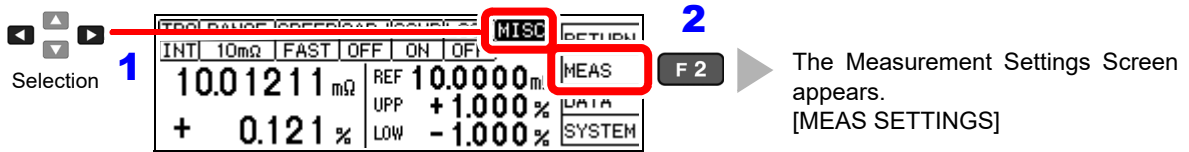

## 3 Enable the scaling function.

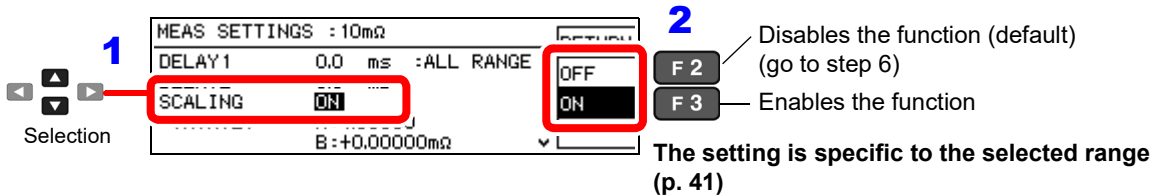

## 4 Set the compensation coefficient.

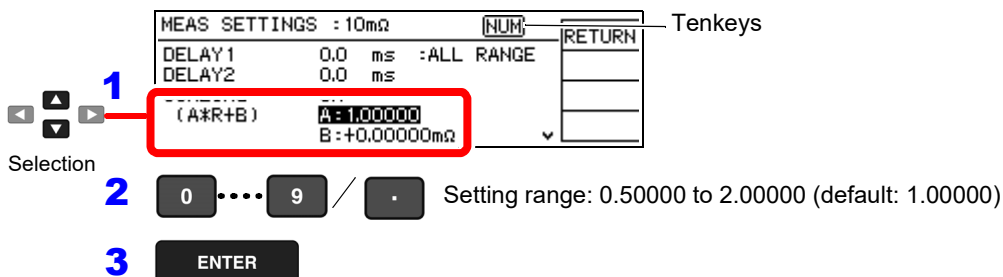

## 5 Set the offset.

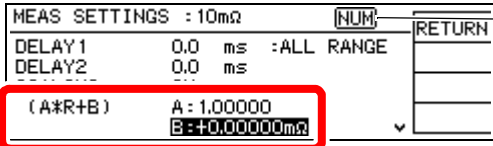

MEAS SETTINGS : 10mΩ NUM: RETURN Tenkeys

DELAY1 0.0 ms :ALL RANGE

DELAY2 0.0 ms

(A\*R+B) A: 1.00000

B: +0.00000mΩ

Selection

2 0 ..... 9 / . Setting range: ±10% of full scale for each range (default: 0 mΩ)

3 ENTER

## 6 Return to the Measurement screen.

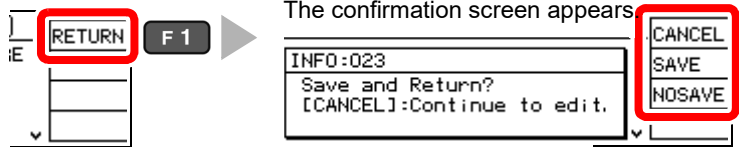

The confirmation screen appears

INFO:023

Save and Return?

[CANCEL]:Continue to edit.

CANCEL

SAVE

NOSAVE

F 1 Return to the setting screen.

F 2 Save setting and return to previous screen.

F 3 Discard setting and return to previous screen.

### NOTE

- Scaling calculation is performed on measured values after zero-adjustment calculation. Consequently, measured values may not equal zero even after zero adjustment.
- For the purpose of setting the offset resistance value, range full-scale signifies 1,200,000 dgt.

# 4.4 Setting the Measurement Integration Time Option

The integration time can be optionally set for each range by selecting FAST, MED, or SLOW measurement speed. Integration time can be set in ms or PLC\* units.

\* PLC = Power Line Cycle, where one PLC is the period of the power line waveform. At 50 Hz, one PLC = 1/50<sup>th</sup> of a second, and at 60 Hz, one PLC = 1/60<sup>th</sup> of a second.

PLC setting units are useful where measurements may be affected by power line noise (high- or low-resistance measurements)

**Default Settings**

Range	Integration Time [INT]			OVC
	FAST	MED	SLOW	
10mΩ	2.0 ms	5.0 ms	1PLC	ON *1
100mΩ (1A)	1.0 ms	5.0 ms	1PLC	ON *1
100mΩ (100μA)	0.5 ms	5.0 ms	1PLC	ON *1
1000mΩ	0.3 ms	2.5 ms	1PLC	ON *1
10Ω	0.3 ms	2.5 ms	1PLC	ON *1
100Ω	0.3 ms	1.5 ms	1PLC	ON *1
1000Ω	0.3 ms	1.5 ms	1PLC	ON *1

\*1. Two measurements are made within the above integration times.

**1** Open the Basic Settings screen.

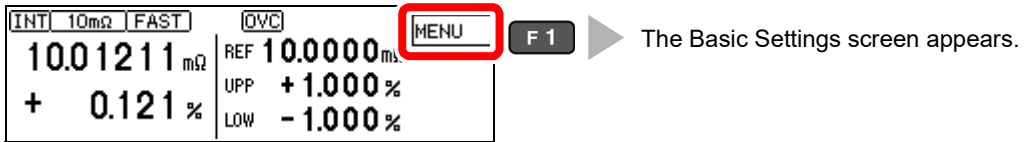

**2** Open the Measurement Settings Screen.

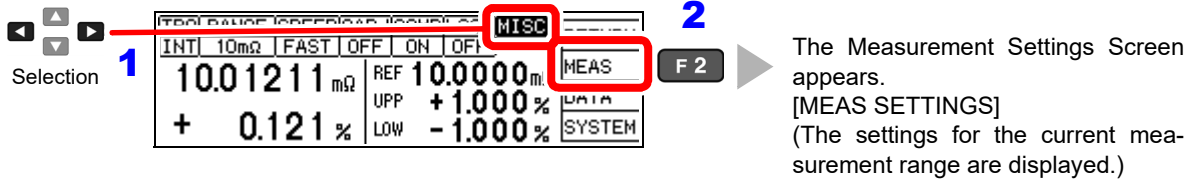

**3** Select the integration setting units.

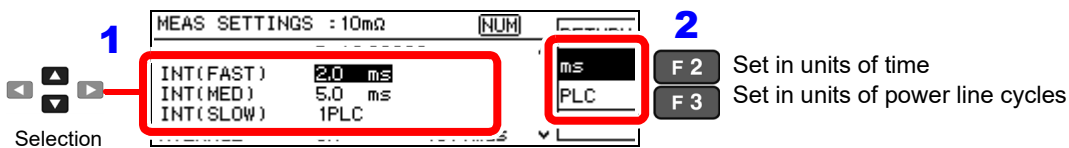

The setting is specific to the selected range (p. 41)

## 4 Select the integration time.

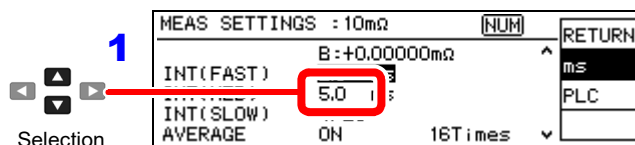

2 [0] ... [9] / [.]

3 [ENTER]

Setting range:

- When setting in ms units: 0.1ms to 100.0ms
- When setting power-line-cycle units: 1 to 6PLC (60 Hz), 1 to 5PLC (50 Hz)

## 5 Return to the Measurement screen.

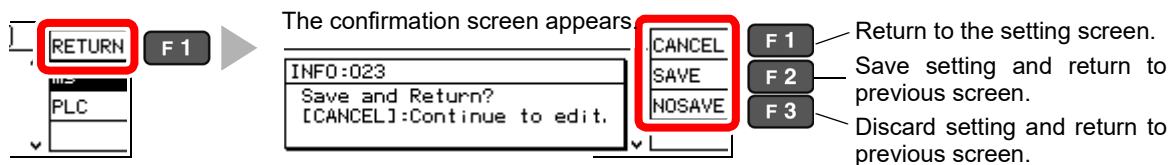

### NOTE

- The instruments accuracy specifications are applicable only with the default integration times. Investigate your measurement requirements carefully before changing the integration time.
- When the effects of power line noise can be ignored, the integration time can be set longer than the default to reduce scattering of measured values. On the other hand, if the integration time is too short, scattering increases.

# 4.5 Stabilizing Measured Values (Averaging Function)

The averaging function averages multiple measured values to stabilize them. Accuracy specifications have been determined for the 16-iteration averaging setting in the 10 mΩ range\*<sup>1</sup>, allowing more precise measurement to be performed.

For internal trigger measurement, a moving average is calculated. For external trigger measurement (and :READ? command operation), a simple average is used.

Default setting      Averaging function:      OFF  
 Number of averaging iterations:      16Times

## 1 Open the Basic Settings screen.

The Basic Settings screen appears.

## 2 Open the Measurement Settings Screen.

The Measurement Settings Screen appears. [MEAS SETTINGS]

## 3 Enable the averaging function.

The setting is specific to the selected range (p. 41)

- Disables the function (default) (go to step 5)
- Enables the function

## 4 Set the number of averaging iterations.

Setting range: 2 to 32 times (default: 16 times)

## 5 Return to the Measurement screen.

The confirmation screen appears

- Return to the setting screen.
- Save setting and return to previous screen.
- Discard setting and return to previous screen.

\*1. SPEED = SLOW setting only.

**NOTE**

Turning on the averaging function lengthens the external trigger measurement (and :READ? command operation) time to (number of averaging iterations × measurement time with averaging turned off). Since a moving average is used for internal trigger measurement, the measurement time does not change.

## 4.6 Checking for Poor or Improper Contact (Contact Check Function)

This function detects poor contact between the probes and DUT, and broken measurement cables. The instrument continually monitors the resistance between the  $H_{CUR}$  and  $H_{POT}$  probes and the  $L_{CUR}$  and  $L_{POT}$  probes from the start of integration (including response time) and while measuring. When the resistance is outside of the specified value, a contact check fault occurs and the **C.E. Hi** or **C.E. Lo** error message appears. No comparator decision is applied to the measured value. When these error messages appear, check the probe contacts, and check for broken measurement cables. If the error is not cleared by shorting the tips of a known-good measurement cable, the instrument requires repair.

### NOTE

- During low-resistance measurement, poor contact of the  $H_{CUR}$  or  $L_{CUR}$  probe may be detected as an out-of-range measurement.
- When contact checking is disabled, measured values may be displayed even when a probe is not contacting the DUT.

### 1 Open the Basic Settings screen.

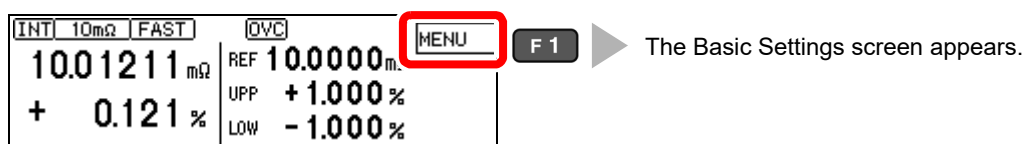

### 2 Open the Measurement Settings Screen.

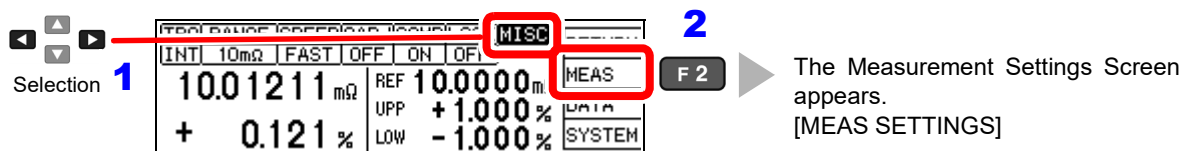

### 3 Enable the Contact Check function.

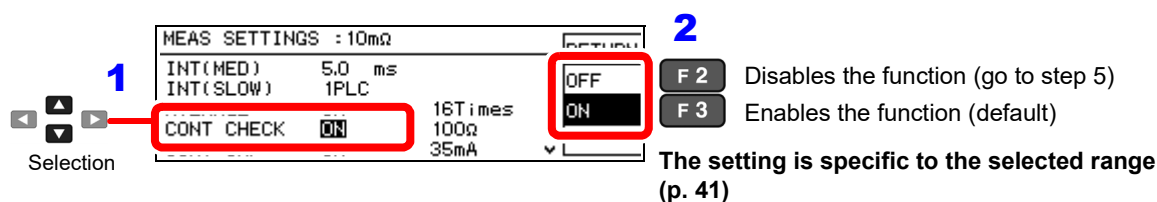

### 4 Select the contact check fault threshold resistance.

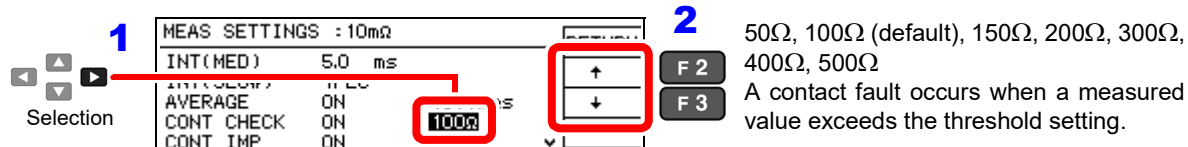

### 5 Return to the Measurement screen.

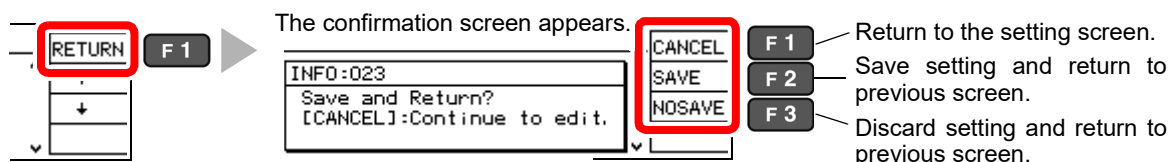

# 4.7 Improving Probe Contact (Contact Improver Function)

Probe contacts can be improved by applying current from the POT to the CUR probes before measuring.

**CAUTION** The Contact Improver function applies voltage to the sample. Be careful when measuring samples with characteristics that may be affected.

The current used for the Contact Improver functions can be selected as follows.

17 mA, 25 mA, 35 mA (default), 50 mA

Higher current provides more effective contact improvement, but at the cost of faster probe deterioration.

Contact Improver current can be set to be disabled (OFF), enabled (ON), or PULSE.

The PULSE setting applies the contact improvement current for about 100  $\mu$ s immediately before measurement. The PULSE setting is useful to decrease Joule heating if the DUT is susceptible to its current.

DUT current	Steady-state current: 2 mA max. *
DUT voltage	15 V max.

\*: It takes several microseconds for the DUT current to reach the steady-state value. Until the steady-state value is reached, a transient current that is approximately equal to the contact improvement current setting (default setting: 35 mA) will flow.

**Timing Chart**

**(Contact Improver Function)**

\* Internal delay is different for each range.

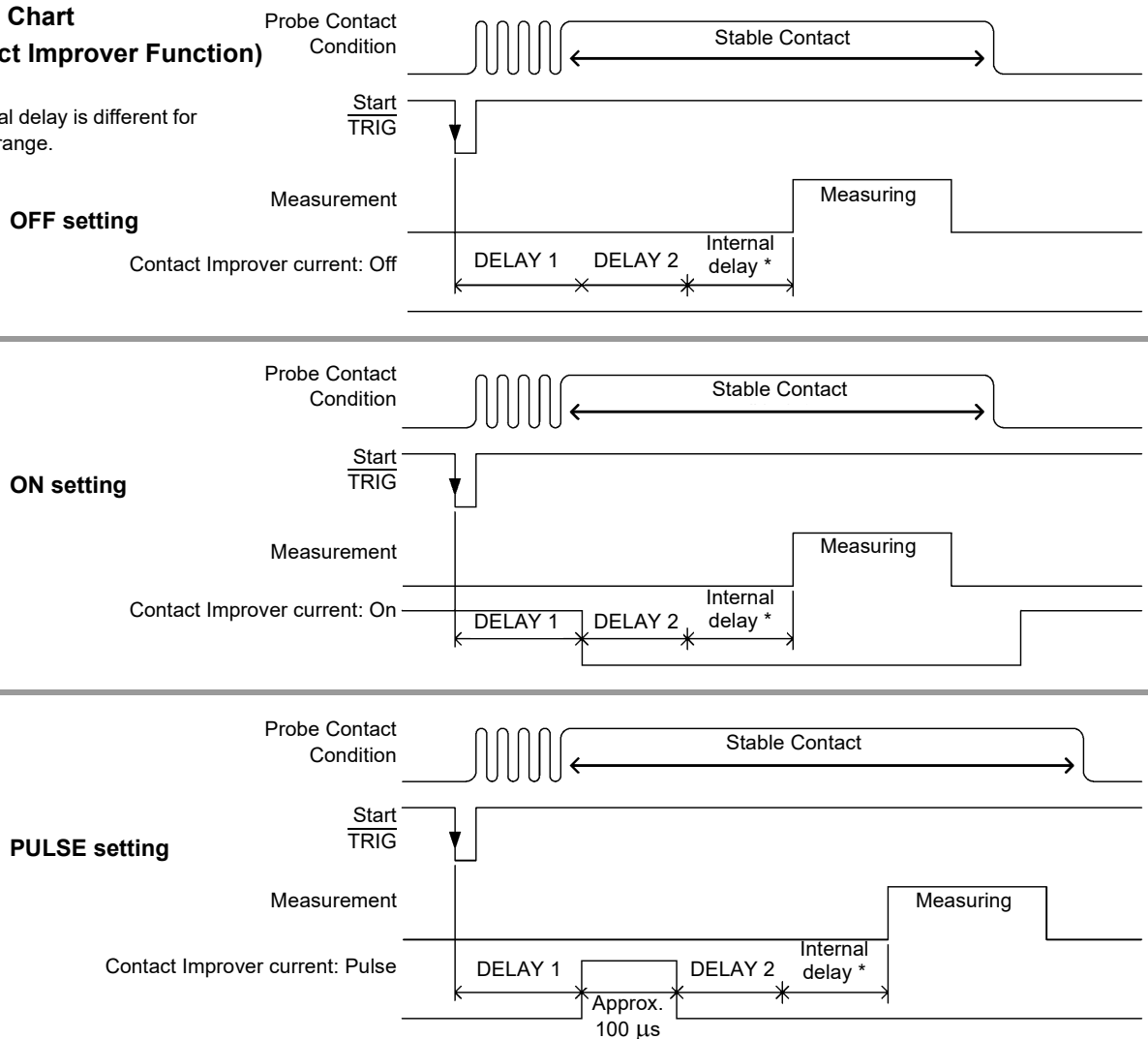



4.7 Improving Probe Contact (Contact Improver Function)

**1** Open the Basic Settings screen.

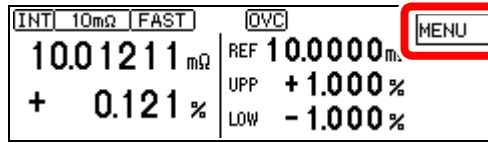

F1 → The Basic Settings screen appears.

**2** Open the Measurement Settings Screen.

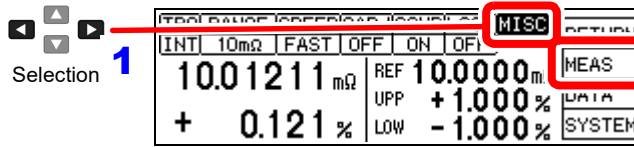

F2 → The Measurement Settings Screen appears. [MEAS SETTINGS]

**3** Set the Contact Improver current timing to disabled (OFF), enabled (ON), or PULSE.

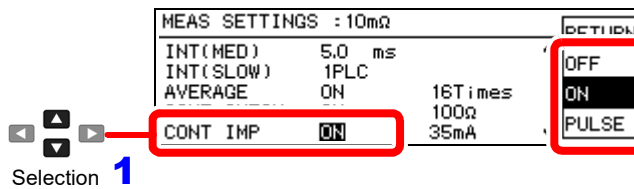

F2 → Disable probe contact improvement (go to step 4).  
 F3 → Enable probe contact improvement.  
 F4 → Apply contact improvement current for about 100 μs immediately before measurement.

The setting is specific to the selected range(p. 41)

(When selecting ON or PULSE)  
 Set the current limit value.

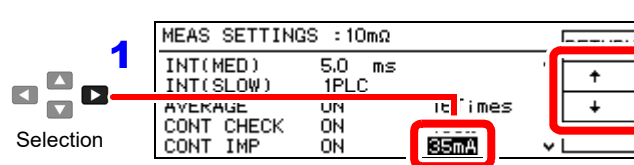

F2 → 17mA, 25mA, 35mA (default), 50mA  
 F3 →

**4** Return to the Measurement screen.

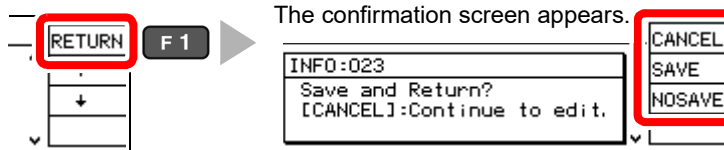

F1 → Return to the setting screen.  
 F2 → Save setting and return to previous screen.  
 F3 → Discard setting and return to previous screen.

4

# 4.8 Detecting Measurement Voltage Faults (Voltage Level Monitor Function)

When a measurement voltage fault occurs due to probe chattering, the **C.E. Volt** error message appears on the measurement screen and an ERR signal is output. The **C.E. Volt** error may also appear when external noise is strong.

Check the following if errors occur frequently:

- Check for probe deterioration.
- Provide additional noise suppression. "Appendix 3 Unstable Measurement Values" (p. A3)
- Set the voltage level monitor to Loose, or OFF (disable).
- Keep wiring away from nearby equipment.

**1** Open the Basic Settings screen.



**2** Open the Measurement Settings Screen.

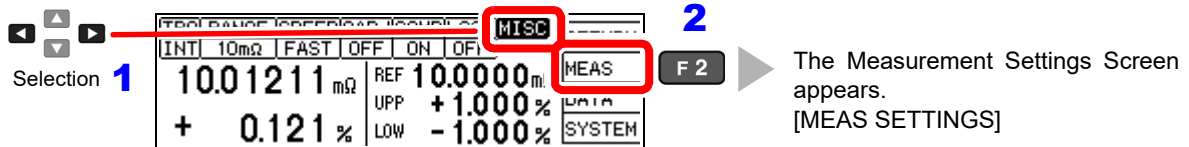

**3** Enable or disable the function.

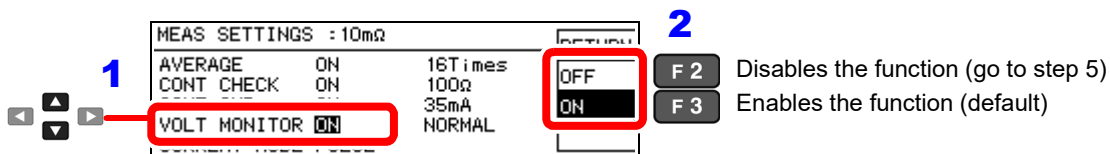

The setting is specific to the selected range (p. 41)

**4** (When enabled (ON selected))  
Select the voltage level monitor threshold.

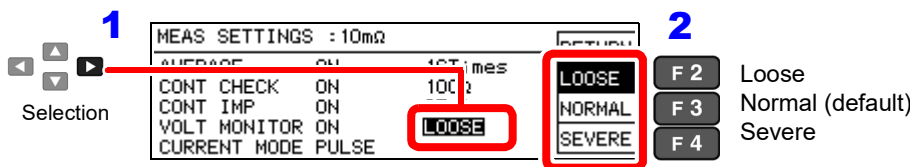

**5** Return to the Measurement screen.

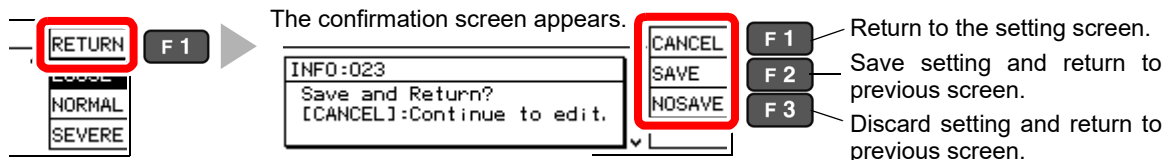

## 4.9 Applying Current Only When Measuring (Current Mode Setting)

When the Contact Improver function is set to Pulse or disabled (CONT IMP: PULSE or OFF) and measurement current is set for pulse output, open-circuit voltage when not measuring does not exceed 20 mV.

See: "4.7 Improving Probe Contact (Contact Improver Function)" (p. 50)

### NOTE

When the Contact Improver function is enabled (CONT IMP: PULSE or ON setting), the current mode setting is ignored even if set to continuous (CURRENT MODE: CONT setting). The Contact Improver function forces pulse operation with measurement current applied only during measurement.

### 1 Open the Basic Settings screen.



### 2 Open the Measurement Settings Screen.

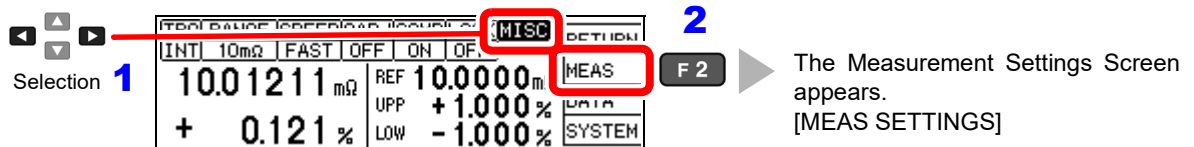

### 3 Select whether to apply current when not measuring.

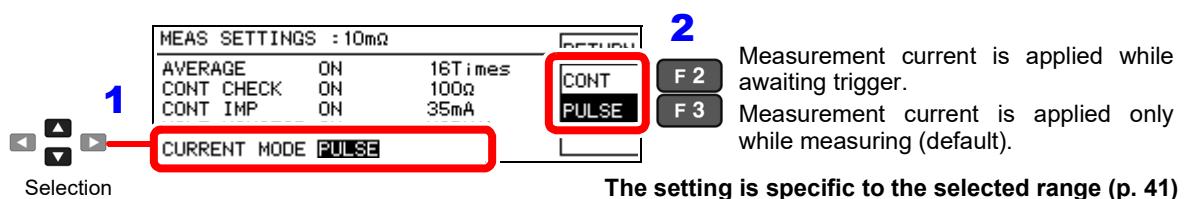

To apply measurement current continuously (CONT setting) even when waiting for a trigger, confirm that the Contact Improver function is disabled (CONT IMP: OFF, (p. 50)).

### 4 Return to the Measurement screen.

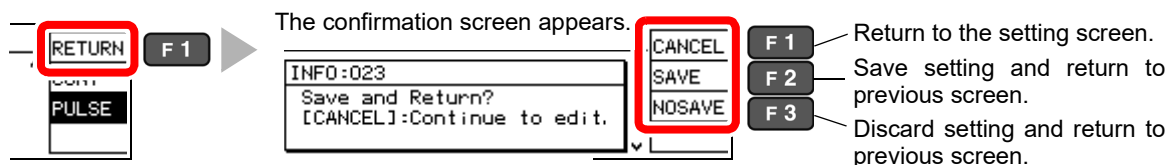

# 4.10 Test for Short-Circuited Probe (Probe Short-Circuit Detection Function)

Four-terminal measurements are not possible when a conductive foreign object is present between the POT and CUR probe tips. To detect short-circuited probes, this function measures the resistance between the CUR and POT terminals after a specific time (initially 5 ms) following the end of measurement. Probe short-circuit detection is disabled by default.

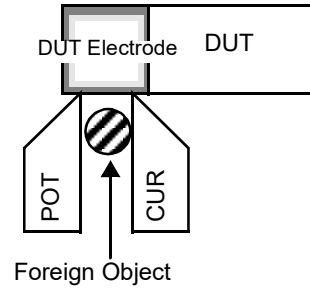

When a probe short-circuit is detected, an error message appears on the measurement screen, and the `PRB_SHORT` and `ERR` signals are output. (ERR:021 Probe short error)

Short-circuit detection can also be controlled by asserting the active-low `PRB_CHECK` EXT I/O signal. Asserting the `PRB_CHECK` signal while measuring causes short-circuit detection to be performed after the end of measurement (p. 89).

### About Probe Short-Circuit Detection

- If probes are connected to the DUT during probe short-circuit detection, the short circuit is detected. Ensure that the probes have sufficient time to separate from the measurement object.
- Probe short-circuit detection occurs within about 1 ms.
- The threshold for probe short-circuit detection is fixed at 500 Ω, so if the resistance between CUR and POT probes is larger, detection is not possible.

Timing Chart (Probe Short-Circuit Detection)

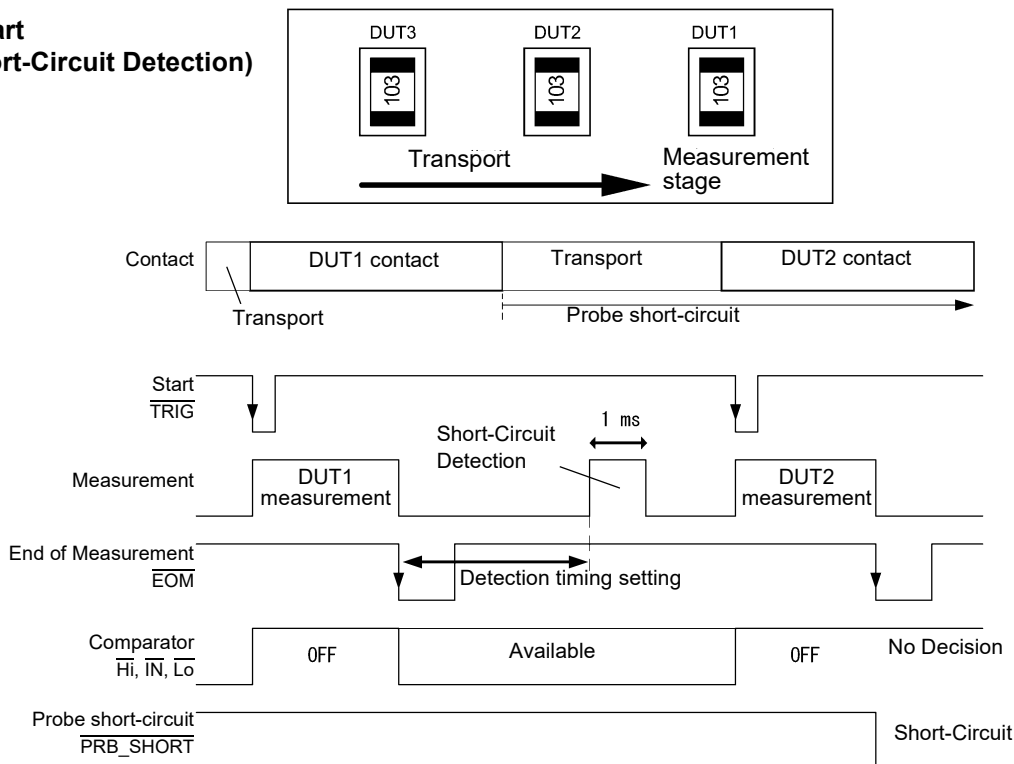

**NOTE**

- Even while the probe short-circuit detection function is set to be disabled, short-circuit detection is performed when the EXT I/O `PRB_CHECK` signal is asserted.
- When the internal trigger [TRG: INT] source is selected, short-circuit detection is not performed after the end of measurement. However, short-circuit detection can still be executed by asserting the `PRB_CHECK` signal.
- If probe short-circuit detection coincides with the timing of self-calibration processing, short-circuit detection will not be performed. Short-circuit detection using the `PRB_CHECK` signal will be performed after self-calibration processing completes.

4.10 Test for Short-Circuited Probe (Probe Short-Circuit Detection Function)

Probe Short-Circuit Detection Enable/Disable

**1** Open the Basic Settings screen.

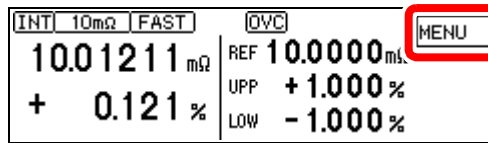

F1 → The Basic Settings screen appears.

**2** Open the System screen.

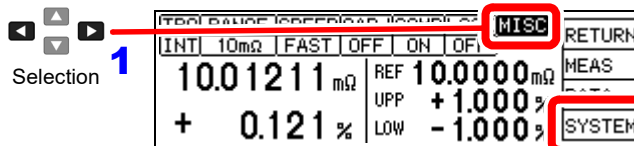

F4 → The System screen appears. [SYSTEM]

**3** Enable or disable the function.

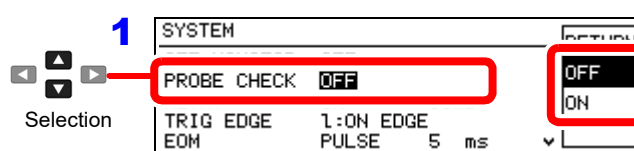

F2 → Disables the function (default) (go to step 5)  
F3 → Enables the function

**4** (When enabled (ON selected))  
Set the probe detection timing.

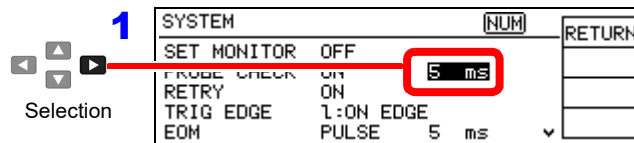

Short-circuit detection is delayed for the specified time following the end of measurement.

**2** 0 ..... 9 Setting range: 1 to 100 ms, 5 ms (default)

**3** ENTER

**5** Return to the Measurement screen.

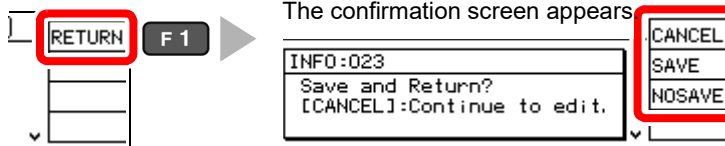

F1 → Return to the setting screen.  
F2 → Save setting and return to previous screen.  
F3 → Discard setting and return to previous screen.

4

# 4.11 Comparing the Measurement Settings of Two Instruments (Settings Monitor Function)



This function automatically compares the settings of two instruments to determine whether they are the same. Only those measurement settings affecting the comparator and speed are compared. When the settings differ, an alarm notification appears and subsequent TRIG signal input is prevented from starting measurement.

When the settings of two instruments match, TRIG input is accepted and measurement starts. However, if the range defined by the upper and lower thresholds of the second stage is broader than that of the first stage, measurement still starts despite the different threshold settings.

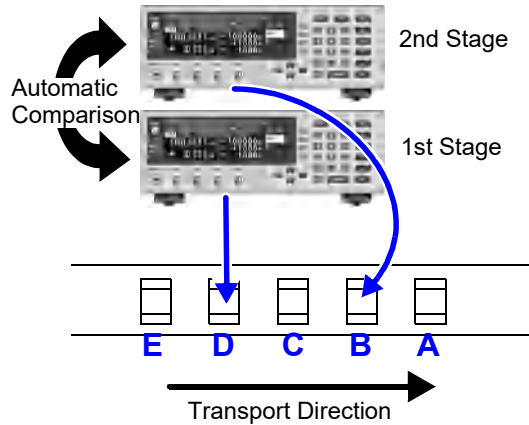

**1** Connect the two instruments' SET MONITOR connectors together using a Hioki 9637 RS-232C cable.

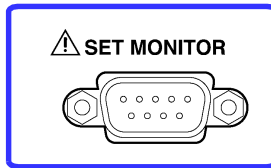
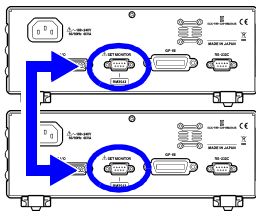

The SET MONITOR connectors are identical to RS-232C connectors. Be careful to avoid connecting the wrong connectors.

**2** Open the Basic Settings screen.

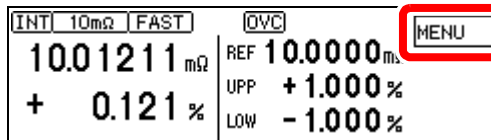

F1 ▶ The Basic Settings screen appears.

**3** Open the System screen.

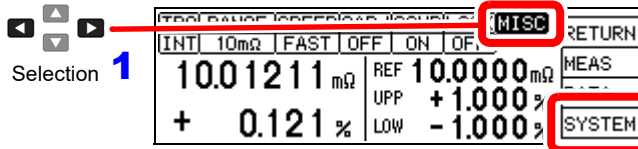

Selection **1**

**2**

F4 ▶ The System screen appears. [SYSTEM]

**4** Enable the function on both instruments.

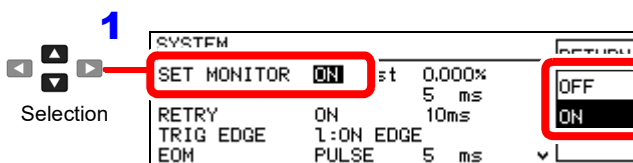

Selection

**2**

F2 Disables the function (default)

F3 Enables the function

4.11 Comparing the Measurement Settings of Two Instruments (Settings Monitor Function)

**5** Select the instrument to serve as the 1st stage, and set its tolerance range.

**1** Selection

**2** F2 Selects this instrument as the 1st stage  
F3 Selects this instrument as the 2nd stage

**3** 0 ... 9 Enter the difference in tolerance (%) to be allowed at the 2nd stage from the tolerance range set for the 1st stage. Setting range: 0.000 to 9.999%

**4** ENTER

Example: If the 1st stage is set to measure  $12\ \Omega \pm 0.800\%$ , and the 2nd is to measure  $12\ \Omega \pm 1.000\%$ , enter the difference in tolerance of 0.300%.

**6** Set the instrument to serve as the 2nd stage (another RM3543).

**1** Selection

**2** F2 Selects this instrument as the 1st stage  
F3 Selects this instrument as the 2nd stage

**7** Return to the Measurement screen.

The confirmation screen appears.

F1 Return to the setting screen.  
F2 Save setting and return to previous screen.  
F3 Discard setting and return to previous screen.

**Tolerance Range Setting Conditions**

Permissible tolerance is calculated using floating-point values, so the setting must be at least 0.001% larger than the difference between 2<sup>nd</sup> and 1<sup>st</sup> stage ranges. Set the upper and lower comparator thresholds according to the following conditions:

- 1<sup>st</sup> stage upper threshold < 2<sup>nd</sup> stage upper threshold
- 1<sup>st</sup> stage lower threshold > 2<sup>nd</sup> stage lower threshold

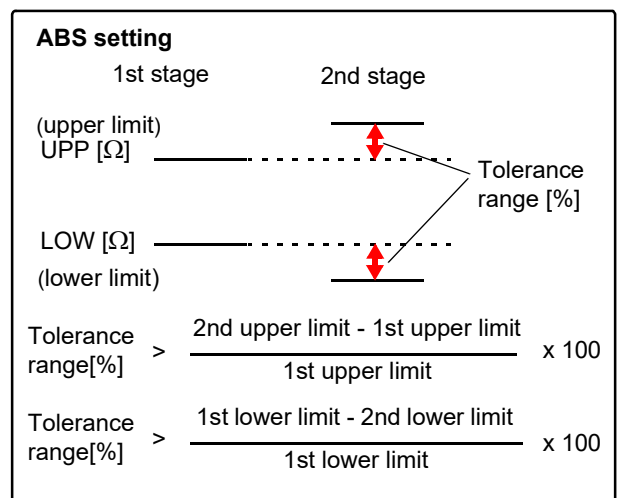
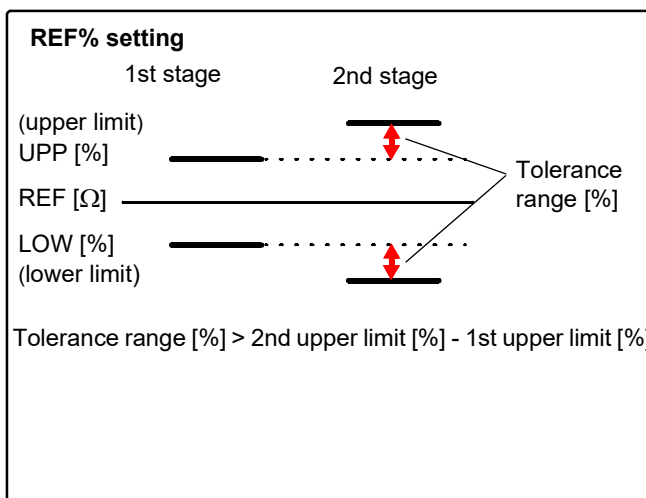

## 4.11 Comparing the Measurement Settings of Two Instruments (Settings Monitor Function)

### Practical Example

**SET MONITOR: ON 1st 0.300%**  
(on the System screen)

**SET MONITOR: ON 2nd**  
(on the System screen)

<b>1st Stage</b>		<b>2nd Stage</b>		TRIG Input Accepted
EXT 1000Ω   FAST	QVC	EXT 1000Ω   FAST	QVC	
REF 124.00 Ω	UPP +0.800 %	REF 124.00 Ω	UPP +1.000 %	
LOW -0.800 %		LOW -1.000 %		

When changing the reference value

<b>1st Stage</b>		<b>2nd Stage</b>		TRIG Input Inhibited
EXT 1000Ω   FAST	QVC	EXT 1000Ω   FAST	QVC	
REF 330.00 Ω	UPP +0.800 %	REF 124.00 Ω	UPP +1.000 %	
LOW -0.800 %		LOW -1.000 %		

ERR:003  
Setting monitor error.(COMP)

The error message appears when the settings do not match.

Change the reference value to match the 1<sup>st</sup> stage

<b>1st Stage</b>		<b>2nd Stage</b>		TRIG Input Accepted
EXT 1000Ω   FAST	QVC	EXT 1000Ω   FAST	QVC	
REF 330.00 Ω	UPP +0.800 %	REF 330.00 Ω	UPP +1.000 %	
LOW -0.800 %		LOW -1.000 %		

#### When an error is displayed

**ERR:003**

**Setting monitor error. (COMP)**

Comparator settings do not match. Please check.

**ERR:004**

**Setting monitor error. (SPEED)**

Measurement speed settings do not match. Please check.



# 4.12 Retrying Measurement After a Fault (Retry Function)

The Retry function causes measurement to be automatically retried when a measurement fault occurs due to probe chatter.

During Retry, all measurement operations including Contact Improvement and DELAY2 (but excluding DELAY1) are restarted.

If a measurement fault persists after the specified continuous retry interval (e.g., if the DUT is not connected), retrying is aborted and the EOM signal is output. When Retry is enabled, the maximum time to end-of-measurement occurs when recovering from a measurement fault immediately before the retry interval expires, which approaches the sum of the retry interval setting plus normal measurement time. Decreasing test throughput may indicate probe maintenance is required.

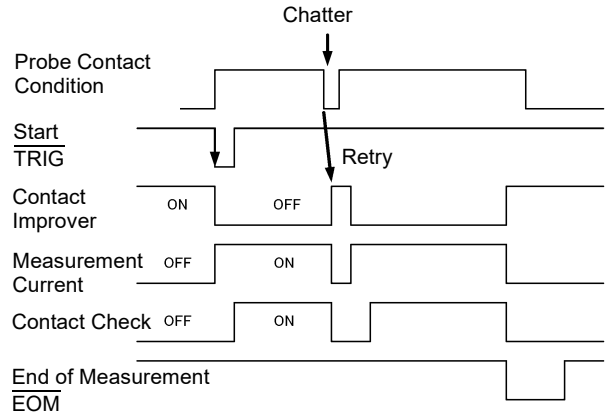

4

## 1 Open the Basic Settings screen.

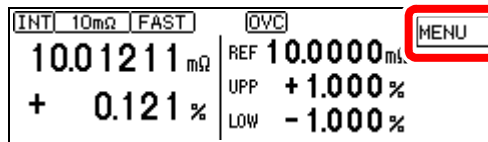

The Basic Settings screen appears.

## 2 Open the System screen.

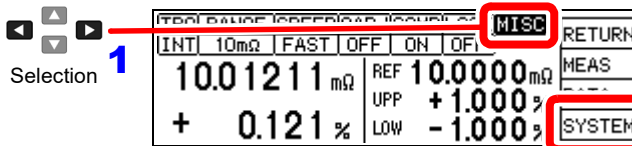

The System screen appears. [SYSTEM]

## 3 Select whether to enable or disable Retry.

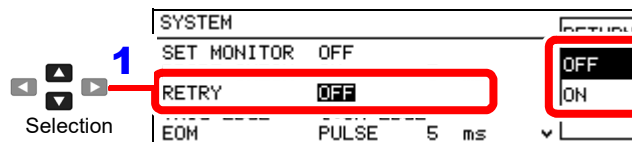

F2 Retry disabled (go to step 5)  
F3 Retry enabled (default)

## 4 (When enabled (ON selected)) Set the continuous retry interval.

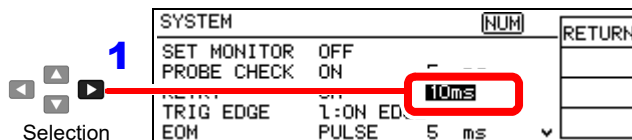

Setting range: 1 to 50 ms (default: 50 ms)

ENTER

## 5 Return to the Measurement screen.

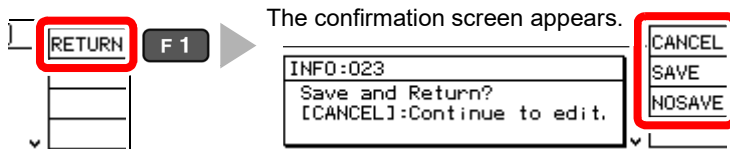

F1 Return to the setting screen.  
F2 Save setting and return to previous screen.  
F3 Discard setting and return to previous screen.

# 4.13 Maintaining Measurement Precision (Self-Calibration)

To maintain measurement precision, the instrument self-calibrates to compensate for internal circuit offset voltage and gain drift. This function cannot be disabled. You can select between two self-calibration function execution methods.

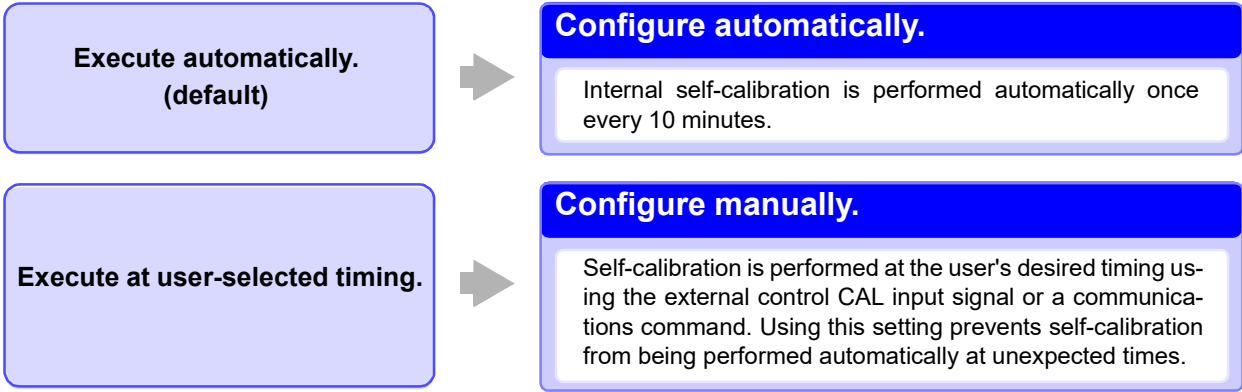

During self-calibration, the subsequent measurement is delayed for about 6PLC + 10 ms (PLC = Power Line Cycles) for internal circuit compensation.

Self-Calibration Timing  
 Within 130 ms at 50 Hz, or 110 ms at 60 Hz

**1** Open the Basic Settings screen.

INT	10mΩ	FAST	OVC	MENU	F 1	▶ The Basic Settings screen appears.
10.01211 mΩ		REF	10.0000 mΩ			
+ 0.121 %		UPP	+1.000 %			
		LOW	-1.000 %			

**2** Open the System screen.

INT	10mΩ	FAST	OFF	ON	OFF	MISC	RETURN
10.01211 mΩ		REF	10.0000 mΩ			▶ The System screen appears. [SYSTEM]	
+ 0.121 %		UPP	+1.000 %				
		LOW	-1.000 %				
				SYSTEM	F 4		

**3** Configure self-calibration operation.

SYSTEM			AUTO	F 2	▶ Configure automatically. (default)
TRIG EDGE	1:ON	EDGE	MANU	F 3	
EOM	PULSE	5 ms			
INTERFACE	RS232C	9600 bps			
CALIBRATION	AUTO				

**4** Return to the Measurement screen.

The confirmation screen appears.

RETURN	F 1	▶	CANCEL	F 1	Return to the setting screen.
			SAVE	F 2	Save setting and return to previous screen.
			NOSAVE	F 3	Discard setting and return to previous screen.

#### 4.14 Compensating for Thermal EMF Offset (Offset Voltage Compensation - OVC)

##### NOTE

- When the timing of self-calibration overlaps with a measurement, self-calibration is postponed until the end of measurement.
- When a trigger signal is applied during self-calibration, the start of the triggered measurement is postponed until self-calibration is finished.
- Self-calibration executes automatically after changing comparator or measurement speed settings.
- During self-calibration, measurement current and the Contact Improver current are inhibited.
- When configuring manually, be sure to perform self-calibration if the temperature of the environment in which the instrument is operating changes by 2 degrees or more. (Accuracy cannot be guaranteed if self-calibration is not performed.)

## 4.14 Compensating for Thermal EMF Offset (Offset Voltage Compensation - OVC)

4

This function automatically compensates for offset voltage resulting from thermal emf or internal instrument bias. (OVC: Offset Voltage Compensation)

See: "Appendix 2 Effect of Thermal emf" (p. A2)

The following value is known to be a true resistance value from  $R_p$  ( $>0$ ), the value measured with current flowing in the positive direction, and  $R_N$  ( $<0$ ), the value measured with current flowing in the negative direction.

$$\frac{R_p - R_N}{2}$$

Offset voltage compensation is automatically enabled for all ranges, and cannot be modified or disabled.

##### NOTE

Depending on the test object, some delay (DELAY2) is required (p. 42) to allow adequate current flow before starting measurement.



# System Settings Chapter 5

## 5.1 Disabling and Enabling Key Operations

### Disabling Key Operations (Key-Lock Function)

Activate the key-lock function to disable the instrument's front panel key operations. Three key-lock levels are available to suit specific purposes.

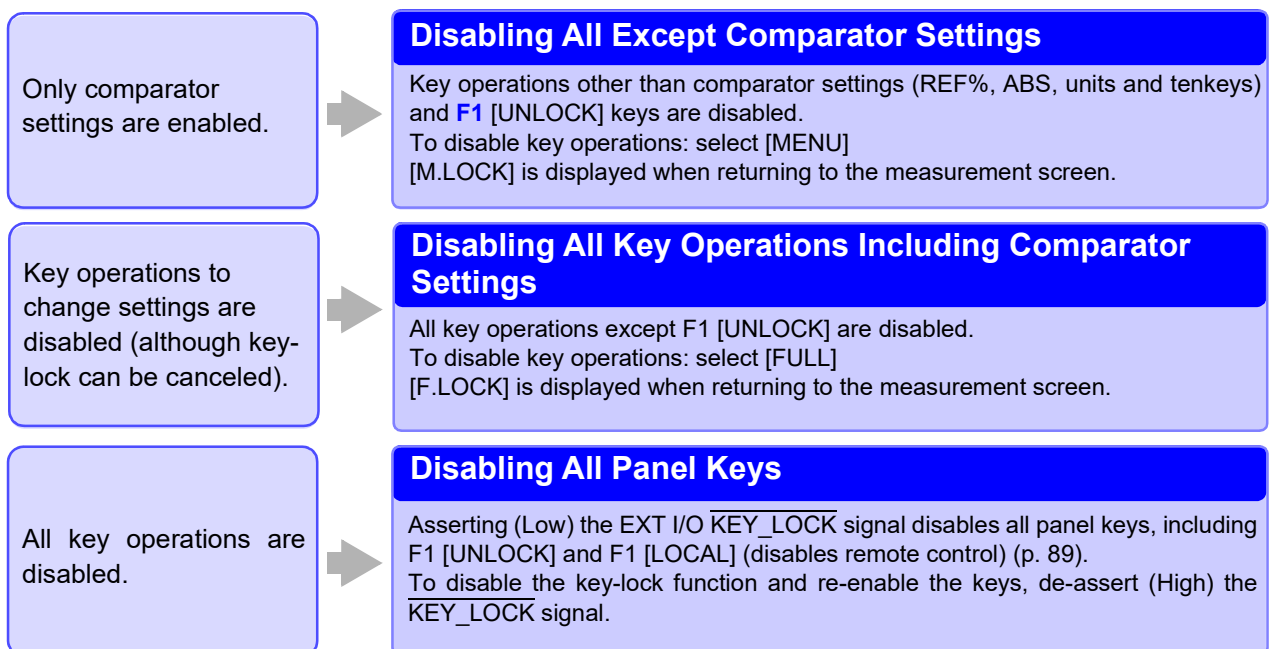

5

### 1 Open the Basic Settings screen.



### 2 Enable or disable key operations.

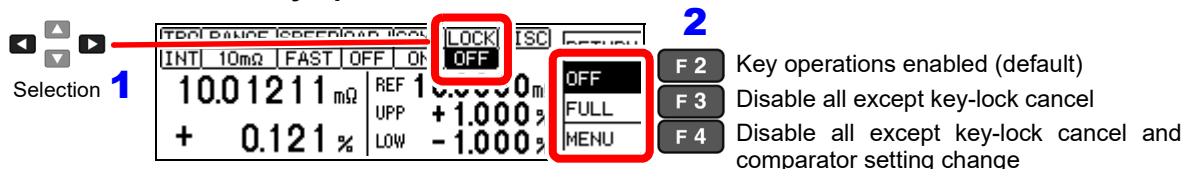

### 3 Return to the Measurement screen.

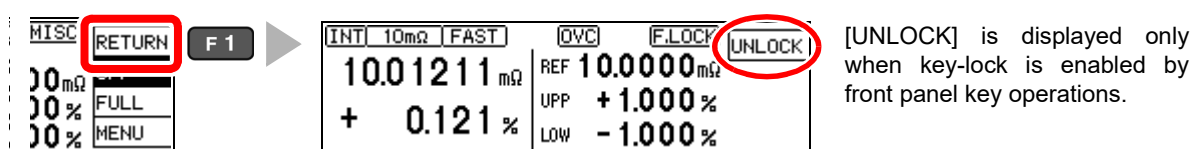

### Re-Enabling Key Operations (Key-Lock Cancel)

Key-lock can be canceled only when [UNLOCK] is displayed.

---

**Press and hold F1 [UNLOCK] for one second.**

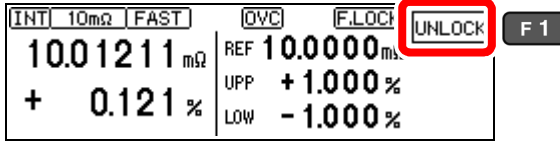

#### NOTE

If key operations are disabled by the  $\overline{\text{KEY\_LOCK}}$  signal, de-assert (High) the signal to unlock the keys.

---

## 5.2 Setting the Comparator Decision and Key Beepers

### Enabling or Disabling the Key Beeper

The key beeper sound can be enabled and disabled.  
The key beeper is enabled (ON) by default.

#### 1 Open the Basic Settings screen.



#### 2 Open the System screen.

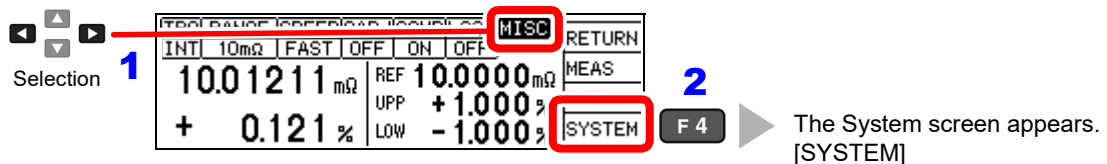

#### 3 Select whether to enable or disable the key beeper.

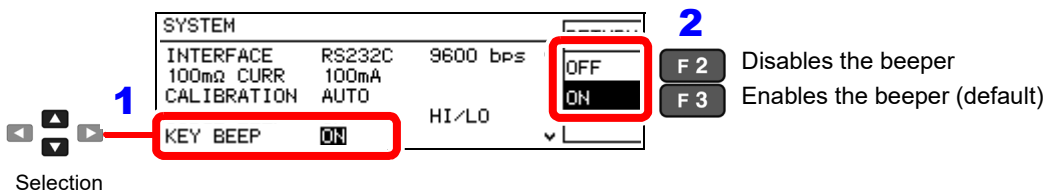

#### 4 Return to the Measurement screen.

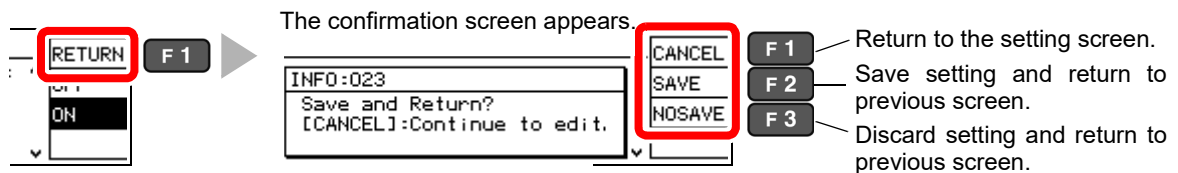

**Setting the Comparator Decision (“JUDGE”) Beeper**

The comparator decision beeper can be enabled and disabled. The decision beeper is disabled (OFF) by default.

**1** Open the Basic Settings screen.

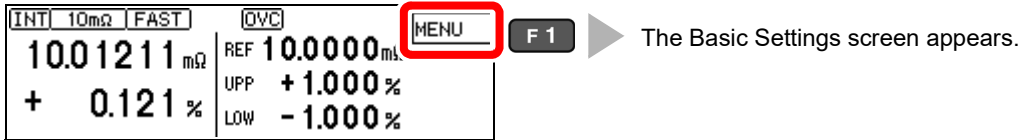

**2** Open the System screen.

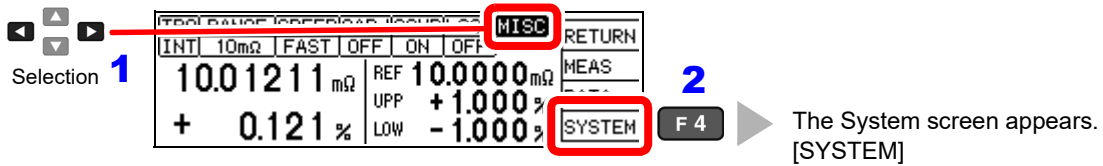

**3** Select whether to enable or disable the decision beeper.

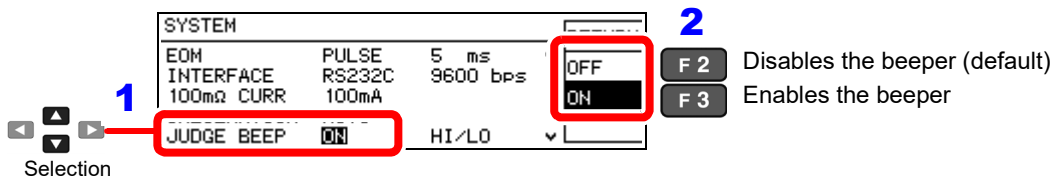

**4** (When enabled (ON selected))  
Select the decision beep conditions.

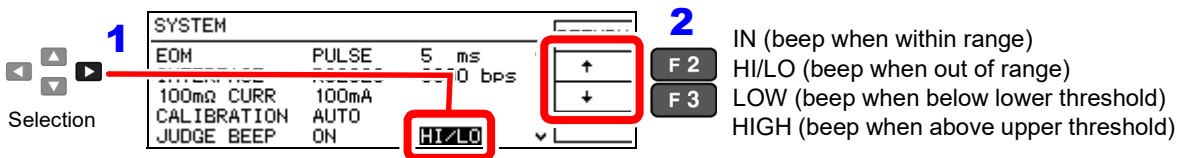

**5** Return to the Measurement screen.

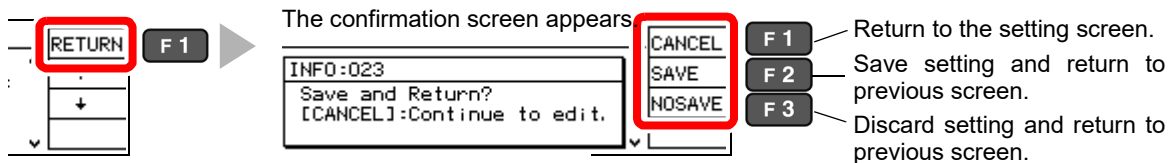



## 5.3 Power Line Frequency Manual Setting

For proper electrical noise suppression, the instrument needs to be set to match the power line frequency. With the default setting (AUTO), the instrument attempts to automatically detect the line frequency, but manual setting is also available.

Unless the line frequency is set correctly, measured values may be unstable.

An error message appears if line noise is high enough to prevent correct frequency detection (ERR:041(p. 185)). In that case, set the instrument's line frequency manually.

### NOTE

When the AUTO setting is selected, the line frequency is automatically set to 50 or 60 Hz when the instrument is turned on or reset.

However, automatic detection is not available when the line frequency changes after turning power on or resetting.

If the actual line frequency deviates from 50 or 60 Hz, select the closest frequency.

Examples:

If the actual line frequency is 50.8 Hz, select the 50 Hz setting.

If the actual line frequency is 59.3 Hz, select the 60 Hz setting.

### 1 Open the Basic Settings screen.



### 2 Open the System screen.

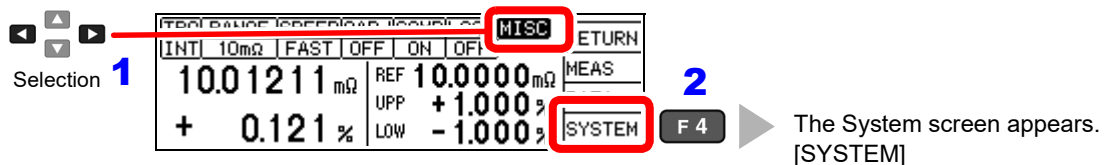

### 3 Select the line frequency being used.

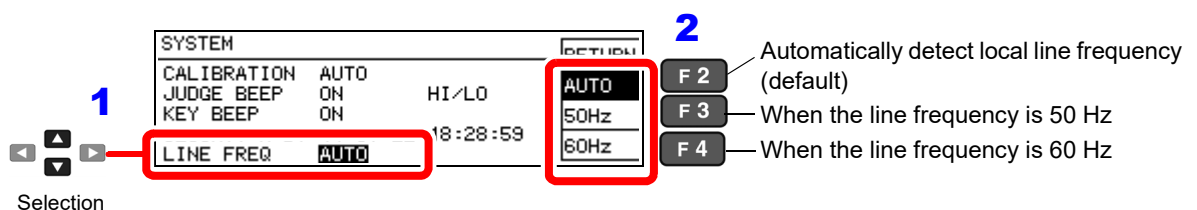

### 4 Return to the Measurement screen.

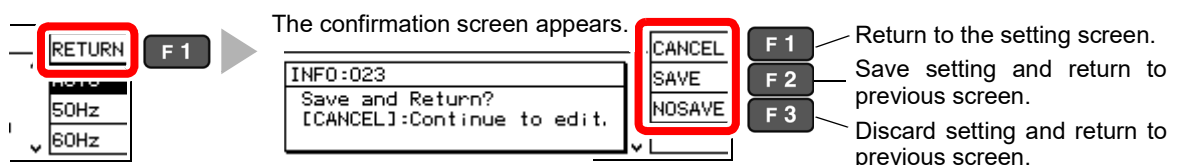

## 5.4 Setting the Clock

To record and print the correct time when using statistical calculations (p. 78), the clock needs to be set correctly. The time of printing is also output when printing statistical calculation results.

### 1 Open the Basic Settings screen.

INT 10mΩ   FAST	OVC	MENU	F 1
10.01211 mΩ	REF 10.0000 mΩ		
+ 0.121 %	UPP +1.000 %		
	LOW -1.000 %		

The Basic Settings screen appears.

### 2 Open the System screen.

Selection 1	MISC	RETURN	2
	INT 10mΩ   FAST OFF   ON   OFF	MEAS	F 4
	10.01211 mΩ	REF 10.0000 mΩ	
	+ 0.121 %	UPP +1.000 %	
		LOW -1.000 %	
		SYSTEM	

The System screen appears.  
[SYSTEM]

### 3 Set the date and time.

Selection 1	SYSTEM	NUM	RETURN
	100mΩ CURR 100mA		
	CALIBRATION AUTO		
	JUDGE BEEP OFF		
	CLOCK(Y-M-D) 11-07-22 18:23:07		

2 0 ... 9 Enter the last two digits of the year, and the month, day, hour, minutes and seconds in that order (the cursor moves automatically).  
Enter two digits for all values (e.g., 09).

### 4 Return to the Measurement screen.

NUM	RETURN	F 1
3:07		

Clock settings cannot be canceled.

## 5.5 Adjusting Screen Contrast

The screen may become hard to see when ambient temperature changes. In this case, adjust the contrast.

### 1 Open the Basic Settings screen.

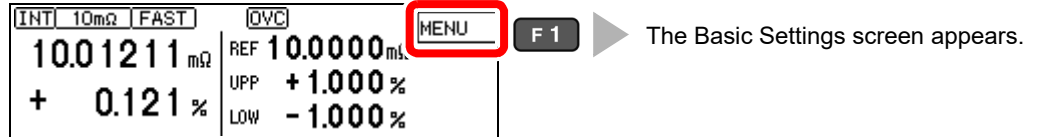

### 2 Open the System screen.

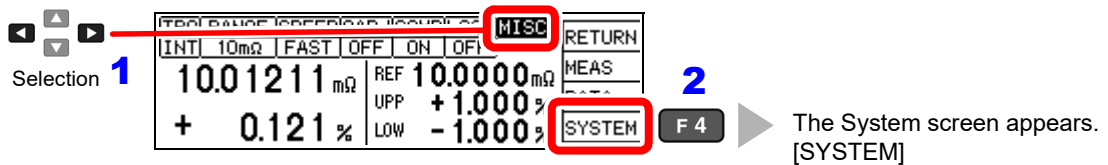

### 3 Adjust the contrast.

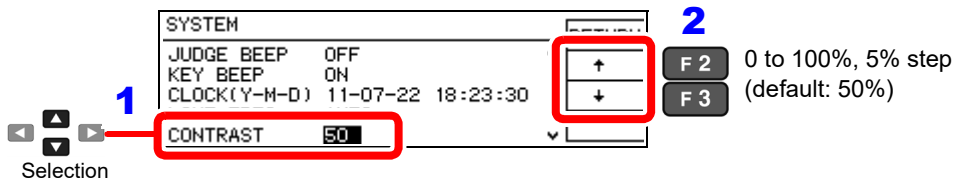

### 4 Return to the Measurement screen.

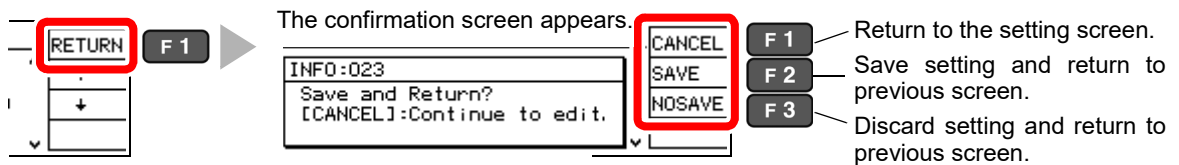

## 5.6 Adjusting the Backlight

Adjust backlight brightness to suit ambient illumination.

### NOTE

- When external (EXT) triggering is selected, backlight brightness is automatically reduced after non-operation for one minute.
- Be aware that the display may be hard to see when brightness is set too low (near 0%).

### 1 Open the Basic Settings screen.



### 2 Open the System screen.

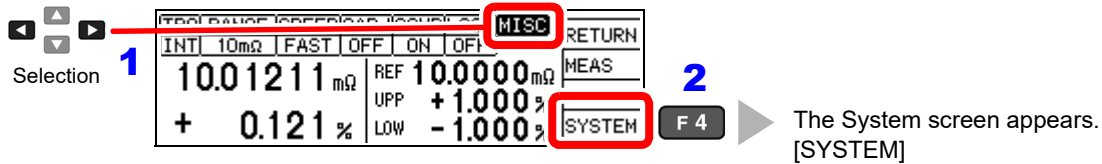

### 3 Adjust the backlight.

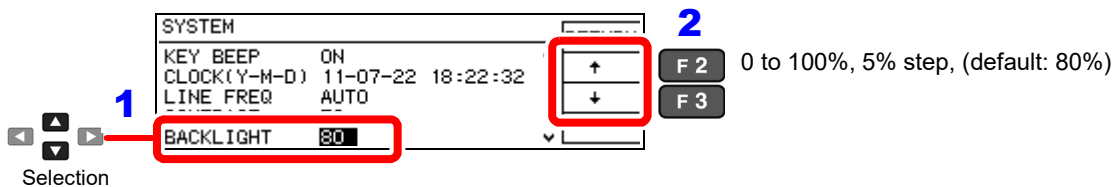

### 4 Return to the Measurement screen.

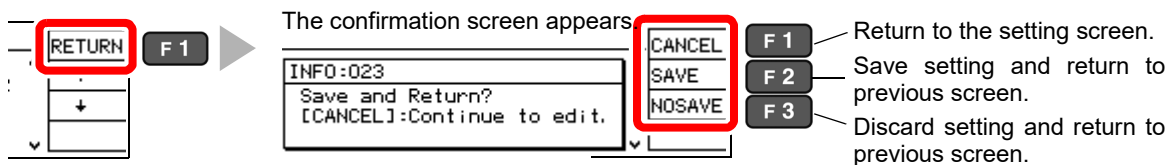

## 5.7 Initializing (Reset)

The instrument can be reset by three methods.

- System reset from the System screen: Returns all settings (except the clock) to factory defaults.
- Turn the instrument on while simultaneously holding the **REF%** and **ABS** keys: Returns all settings (except the clock) to factory defaults.
- Reset by remote control command: returns all settings (except communication and clock settings) to their factory defaults.

\*RST command (non-backup, (p. 127))

:SYSTem:RESet command (p. 141)

This procedure describes system reset from the System screen.

### 1 Open the Basic Settings screen.



The screenshot shows the Basic Settings screen with the following data: INT 10mΩ FAST, OVC, REF 10.0000 mΩ, MENU, 1001211 mΩ, UPP +1.000%, + 0.121%, LOW -1.000%. The MENU key is highlighted with a red box and labeled F1. An arrow points to the text: The Basic Settings screen appears.

### 2 Open the System screen.

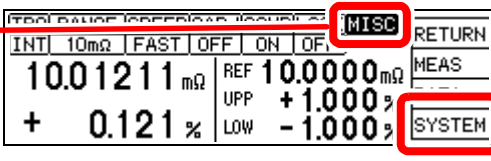

The screenshot shows the Basic Settings screen with the following data: INT 10mΩ FAST OFF ON OF, MISC, RETURN, 1001211 mΩ, REF 10.0000 mΩ, MEAS, + 0.121%, UPP +1.000%, LOW -1.000%. The MISC key is highlighted with a red box and labeled F4. An arrow points to the text: The System screen appears. [SYSTEM].

### 3 Select RESET.

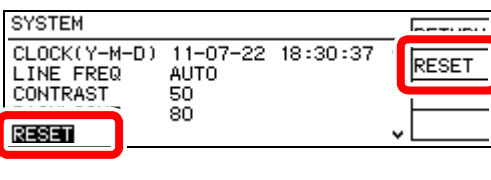

The screenshot shows the System screen with the following data: SYSTEM, CLOCK(Y-M-D) 11-07-22 18:30:37, LINE FREQ AUTO, CONTRAST 50, 80, RESET, RETURN. The RESET key is highlighted with a red box and labeled F2. An arrow points to the text: Returns all settings to their factory defaults.

### 4 Select whether to cancel or proceed to execute system reset.

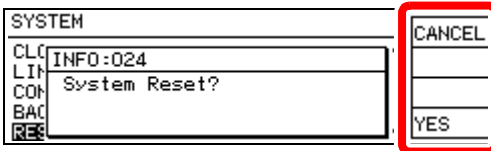

The screenshot shows the System screen with the following data: SYSTEM, CLC INFO:024, LIN System Reset?, COM, BAC, RES, CANCEL, F1, YES, F4. The CANCEL and YES keys are highlighted with red boxes. Arrows point to the text: Cancel the operation and Execute.

The Measurement screen is displayed when system reset finishes.

## Default Settings

Display	Setting value	Default Settings	Setting Description	
<b>MENU</b>	TRG	INT/ EXT/ MANU	EXT	Trigger source selection (p. 30)
	RANGE	10mΩ/ 100mΩ/ 1000mΩ/ 10Ω/ 100Ω/ 1000Ω	1000 Ω	Range selection (p. 31)
	SPEED	SLOW/ MED/ FAST	FAST	Measurement speed (p. 29)
	0ADJ	OFF/ ON	OFF	Zero adjustment (p. 32)
	COMP	OFF/ ON	ON	Comparator function(p. 34)
	LOCK	OFF/ FULL / MENU	OFF	Key-Lock function (p. 63)
	MISC	MEAS/ DATA/ SYSTEM		(Miscellaneous settings)
<b>MISC</b>				
<b>MEAS</b>	DELAY1	0 to 100 ms (all ranges)	0 ms	Probe delay setting (p. 42)
	DELAY2	0 to 100 ms	0 ms	DUT response setting (p. 42)
	SCALING	OFF/ ON Coefficient A Offset B	OFF A: 1 B: 0	Scaling function (p. 44)
	INT (FAST)	0.1 ms to 100 ms	Depends on measurement range	Integration time (p. 46)
	INT (MED)	1PLC to 6PLC (60 Hz)		
	INT (SLOW)	1PLC to 5PLC (50 Hz)		
	AVERAGE	OFF/ ON 2 to 32 times	OFF, 16Times	Averaging function (p. 48)
	CONT CHECK	OFF/ ON 50 Ω/ 100 Ω/ 150 Ω/ 200 Ω/ 300 Ω/ 400 Ω/ 500 Ω	ON, 100 Ω	Contact-check (p. 49)
	CONT IMP	OFF/ ON/ PULSE 17 mA/ 25 mA/ 35 mA/ 50 mA	ON, 35 mA	Contact Improvement (p. 50)
	VOLT MONITOR	OFF/ ON LOOSE/ NORMAL/ SEVERE	ON, NORMAL	Voltage level monitor (p. 52)
	CURRENT MODE	CONT/ PULSE	PULSE	Current mode setting (p. 53)
<b>DATA</b>	AUTO MEMO- RY	OFF/ ON	OFF	Auto-Memory function (p. 75)
	STATISTICS	OFF/ ON	OFF	Statistical calculation function (p. 78)
	DATA OUT	OFF/ ON	OFF	Data output function (p. 81)
<b>SYS- TEM</b>	SET MONITOR	OFF/ ON, 1st/ 2nd, 0.000% to 9.999%	OFF, 1st, 0.000%	Settings Monitor function (p. 56)
	PROBE CHECK	OFF/ ON, 0 to 100 ms	OFF, 5 ms	Probe short-circuit detection (p. 54)
	RETRY	OFF/ ON, 1 to 50 ms	ON, 50 ms	Retry function (p. 59)
	TRIG EDGE	OFF EDGE/ ON EDGE	ON EDGE	Start Logic Setting (p. 98)
	EOM	PULSE/ HOLD 1 to 100 ms	PULSE, 5 ms	End-of-measurement pulse width (p. 97)
	INTERFACE	GP-IB/ RS232C/ PRINT	RS232C, 9600bps GP-IB, ADR01, LF	Interface setting (p. 105)
	100mΩ CURR	100mA/ 1A	100mA	Switching 100 mΩ range measurement currents (p. 28)
	CALIBRATION	AUTO/ MANU	AUTO	Self-calibration operation settings (p. 60)
	JUDGE BEEP	OFF/ ON IN/ HI/LO/ LOW/ HIGH	OFF, HI/LO	Comparator decision beeper (p. 65)
	KEY BEEP	OFF/ ON	ON	Key beeper (p. 63)
	CLOCK			Clock setting (p. 68)
	LINE FREQ	AUTO/ 50 Hz/ 60 Hz	AUTO	Line frequency (detection) (p. 67)
	CONTRAST	0 to 100	50	Screen contrast adjustment (p. 69)
	BACK LIGHT	0 to 100	80	Screen backlight adjustment (p. 70)
	RESET	-	-	Reset (p. 71)
ADJUST	-	-	Calibration (p. A16)	

# Storing and Exporting Data

## Chapter 6

Measured values can be stored or automatically exported, according to application. Stored data can be output to a printer, RS-232C or GP-IB. Also, statistical calculations can be applied to internally stored data.

Stored measurements are lost when the instrument is turned off.  
Therefore, be sure to print out or export important data to a PC.

Store measured values at specific times.  
This is convenient for batch exporting data to a controller while switching reels.



### Data Memory Function (p. 74)

Store up to 30,000 measured values using the EXT I/O TRIG signal or by pressing F4 [MANU] on the Basic Settings screen.

Store data after measured value has stabilized.  
This is convenient for sample inspection after printing (vapor deposition) resistors on a board.



### Auto-Memory Function (p. 75)

Measured values are automatically stored as they become stable.  
When the specified number of data points (up to 99) is acquired, the beeper sounds and auto-storing halts.

Automatically output (export) measurements at the end of measurement.



### Data Output Function (p. 81)

Minimizes transfer time by eliminating the need for transmit requests from the remote controller. (RS-232C interface only)

#### NOTE

The data memory and auto-memory functions cannot be enabled at the same time.

## 6.1 Storing Data at Specific Times (Data Memory Function)

Measured values are stored in the instrument's internal memory according to the following timings. (up to 30,000 points)

- Every time a measurement is performed by external (EXT) triggering
- When a trigger is applied during internally (INT) triggered measurement

The following three storage methods are available:

- Store upon receiving an EXT I/O  $\overline{\text{TRIG}}$  signal (p. 89)
- Store upon receiving a \*TRG command (p. 130)
- Store by pressing the **F4** [MANU] key on the [MENU] – [TRG] setting screen.

### NOTE

- This function can only be enabled by remote control. The data memory function should be enabled by remote control beforehand. This setting is not available from the front panel.
- Stored memory data cannot be viewed on the instrument's screen. Use remote control commands to export stored data.

### Data Memory Function Operating Procedure

# 1

#### Enable data memory mode.

Send this remote command to enable the data memory function:

**:MEMory:MODE MEMory** (p. 146)

# 2

#### Store measured values.

Execute external trigger measurement, or apply a trigger during internally triggered measurement.

# 3

#### Export the stored data.

Send this remote command to export the measured values stored in the instrument:

**:MEMory:DATA?** (p. 147)

# 4

#### Clear measurement data from instrument memory.

Send this remote command to erase the data from instrument memory:

**:MEMory:CLEar** (p. 146)

Stored data is automatically erased at the following times:

- when the memory function setting (including auto-memory) is changed (p. 146)
- when the range is changed (p. 31)
- when changing comparator settings (p. 34)
- when the scaling setting for the current range is changed (p. 44)
- when printing the statistical calculations (p. 86)
- when the DUT is changed (p. 28)
- upon system reset (p. 71)
- when the instrument is turned off



## 6.2 Store as soon as Measurement is Stable (Auto-Memory Function)

This function automatically stores the value measured each time the probes contact the sample with internal triggering. When the specified number of values has been acquired, auto-storage operation stops.

Statistical calculations are applied to the stored data, with results output to the screen or printer (RS-232C).

See: "6.3 Performing Statistical Calculations on Measured Values" (p. 78)  
"Chapter 7 Printing" (p. 83)

Data storage and printing can be automatically controlled by the Auto-Memory function.

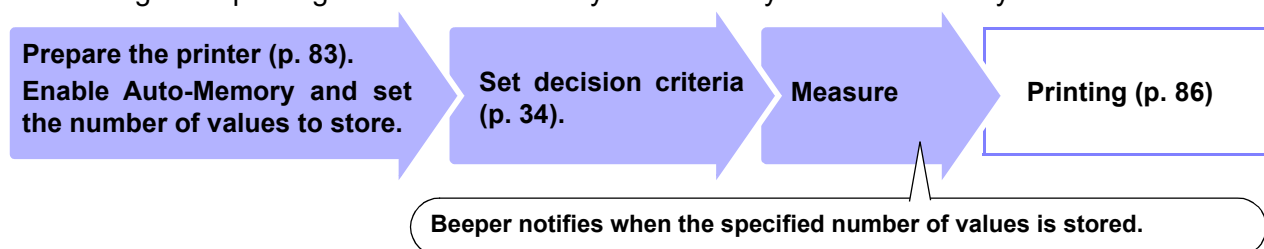

The Auto-Memory function is disabled by default.

Enable the Auto-Memory function before setting the number of values to store.

Enabling the Auto-Memory function affects other functions as follows:

- Statistical calculation is forced on.
- The voltage level monitor function is forced off (although the setting itself is not set to OFF, the function is actually disabled).
- The trigger source setting is forced to internal (INT).

### NOTE

When the trigger source is set to external (EXT), the Auto-Memory function is disabled by force.

### Deleting Stored Data

Stored data is automatically erased at the following times:

- when the memory function setting (including auto-memory) is changed (p. 146)
- when the range is changed (p. 31)
- when changing comparator settings (p. 34)
- when the instrument is turned off
- when the scaling setting for the current range is changed (p. 44)
- when printing the statistical calculations (p. 86)
- when the DUT is changed (p. 28)
- upon system reset (p. 71)
- upon setting the auto-memory number of values to store (p. 77)
- when the instrument is turned off

## 6.2 Store as soon as Measurement is Stable (Auto-Memory Function)

### Enabling the Auto-Memory Function

**1** Open the Basic Settings screen.

INT 10mΩ	FAST	QVC	MENU	F1
10.01211 mΩ	REF 10.0000 mΩ			
+ 0.121 %	UPP +1.000 %			
	LOW -1.000 %			

The Basic Settings screen appears.

**2** Open the Data Memory Settings screen.

Selection	1	MISC	2	RETURN	F3
		INT 10mΩ	FAST OFF	ON	OF.
		10.01211 mΩ	REF 10.0000 mΩ		
		+ 0.121 %	UPP +1.000 %		
			LOW -1.000 %		

The Data Settings screen appears. [DATA SETTINGS]

**3** Enable the function.

Selection	1	AUTO MEMORY	2	OFF	F2
		DATA OUT		ON	F3

Disable the function (default)

Enable the function

**4** Return to the Measurement screen.

RETURN	F1	CANCEL	F1
ON		SAVE	F2
		NOSAVE	F3

The confirmation screen appears.

Return to the setting screen.

Save setting and return to previous screen.

Discard setting and return to previous screen.

When the function is enabled

INT 10mΩ	FAST	QVC	MENU
10.01211 mΩ	REF 10.0000 mΩ		
+ 0.121 %	UPP +1.000 %		
	LOW -1.000 %		
COUNT	PASS	FAIL	STAT
0/10	0/10	0/10	NUMBER

## 6.2 Store as soon as Measurement is Stable (Auto-Memory Function)

### Setting the Number of Values to Store

- 1 Open the Auto-Memory Settings screen.

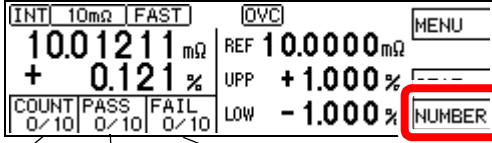

Displays the Auto-Memory setting screen

Total Count Pass Count (IN) Fail Count (Hi/Lo)

- 2 Enter the number of values to store.

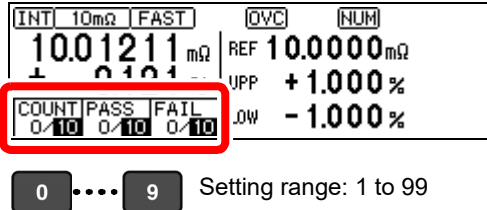

Setting range: 1 to 99

#### To Reset Numerical Values

- BACK SPACE** Deletes entered digits. This key is enabled only when entering numerical values.

To abort the setting process, press **ESC**. Settings are abandoned and the display returns to the previous screen.

- 3 Accept the settings and return to the Measurement screen.

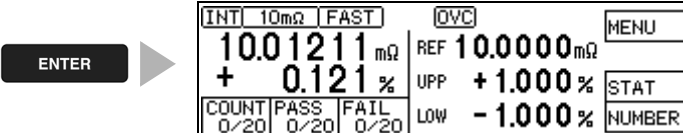

(Example: 20 values set to be stored)

### Acquiring Measured Values Automatically

- 1 Momentarily disconnect (open-circuit) the probes.

- 2 Connect the probes to the DUT.

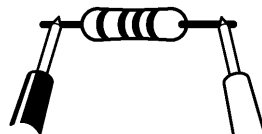

When the measurement is stable, the value is automatically stored and the count is incremented. When the count reaches the specified number of values, a long beep sounds, and subsequent measurements are not stored. The (one) last acquired value can be deleted (Undo function (p. 80)).

## 6.3 Performing Statistical Calculations on Measured Values

Statistical calculations can be performed on up to 30,000 measured values, with results displayed. Printing is also available (p. 86).

Calculation types: average, maximum and minimum values, population standard deviation, sample standard deviation, process compatibility indices

<b>Maximum value</b>	$X_{max} = MAX(x_1, \dots, x_n)$
<b>Minimum value</b>	$X_{min} = MIN(x_1, \dots, x_n)$
<b>Average</b>	$\bar{x} = \frac{\sum x}{n}$
<b>Population standard deviation</b>	$\sigma_n = \sqrt{\frac{\sum x^2 - n\bar{x}^2}{n}}$
<b>Standard deviation of sample</b>	$\sigma_{n-1} = \sqrt{\frac{\sum x^2 - n\bar{x}^2}{n-1}}$
<b>Process capability index (dispersion)*</b>	$Cp = \frac{ Hi - Lo }{6\sigma_{n-1}}$
<b>Process capability index (bias)*</b>	$CpK = \frac{ Hi - Lo  -  Hi + Lo - 2\bar{x} }{6\sigma_{n-1}}$

In these formulas, n represents the number of valid data samples.

Hi and Lo are the upper and lower thresholds of the comparator.

\*. The process capability indices represent the quality achievement capability created by a process, which is the breadth of the dispersion and bias of the process' quality. Generally, depending on the values of Cp and CpK, process capability is evaluated as follows:

- Cp, CpK > 1.33 ..... Process capability is ideal
- 1.33 ≥ Cp, CpK > 1.00 Process capability is adequate
- 1.00 ≥ Cp, CpK ..... Process capability is inadequate

- When only one valid data sample exists, standard deviation of sample and process capability indices are not displayed.
- When  $\sigma_{n-1} = 0$ , Cp and CpK are 99.99.
- The upper limit of Cp and CpK is 99.99. If Cp or CpK exceeds 99.99, the value 99.99 is displayed
- Negative values of CpK are handled as CpK = 0.
- If statistical calculation is turned off and then back on again without first clearing calculation results, calculation resumes from the point when it was turned off.
- Measurement speed is restricted when statistical calculation is enabled.
- When Auto-Memory is enabled (ON), statistical calculation is enabled (ON) by force.
- When statistical calculation is disabled (OFF), Auto-Memory is disabled (OFF) by force.

### Deleting Statistical Calculation Results

Stored data is automatically erased at the following times:

- when the memory function setting (including data-memory) is changed (p. 146)
- when the range is changed (p. 31)
- when changing comparator settings (p. 34)
- when the scaling setting for the current range is changed (p. 44)
- when printing the statistical calculations (p. 86)
- when the DUT is changed (p. 28)
- upon system reset (p. 71)
- upon setting the auto-memory number of values to store (p. 77)
- when the instrument is turned off

## Using Statistical Calculations

When statistical calculation is enabled and an EXT I/O trigger signal is applied, operation is as follows depending on the trigger source setting:

- With external (EXT) triggering: One measurement is performed and subjected to statistical calculation.
- With internal (INT) triggering: The next measured value after the trigger signal is subjected to statistical calculation.

Operation is the same in the following cases:

(Key Operations)

- when pressing the **F4** [MANU] key on the [MENU] - [TRG] selection screen
- when pressing the **F2** [PRINT] key on the Measurement screen (with internal triggering and Auto-Memory disabled. Appears only when the interface is set for the printer.)
- when acquiring measured values by the Auto-Memory function (p. 75)

(Remote Control)

- when a TRG remote control command is received
- when an EXT I/O print signal is applied on the Measurement screen (with internal triggering and Auto-Memory disabled)

### 1 Open the Basic Settings screen.



### 2 Open the Data Memory Settings screen.

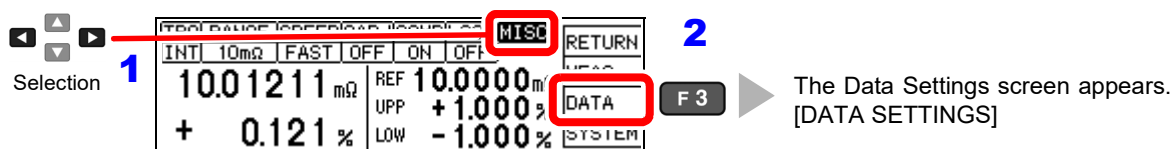

### 3 Enable or disable statistical calculation.

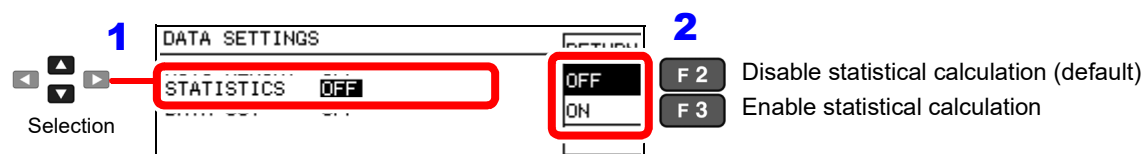

### 4 Return to the Measurement screen.

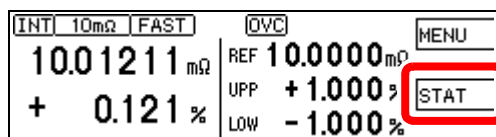
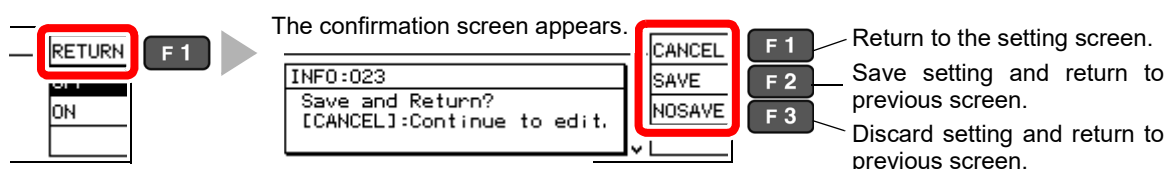

When statistical calculation is enabled, F3 [STAT] appears on the Measurement screen. Confirm calculation results (p. 80)

**Confirming, Printing, and Erasing Calculation Results**

Statistical calculation results are displayed on the screen.

Printing is also available with the commercially available printer with a serial interface. Calculation results are automatically erased after printing. Before printing, select the [PRINT] interface setting.

See: "7.2 Instrument Settings" (p. 85)

The number of valid samples can be confirmed on the Calculation Results screen.

- When the number of valid samples is zero, no calculation results are displayed.
- When only one valid data sample exists, no standard deviation or process capability indices are displayed.

**1 Display the Calculation Results screen.**

INT 10mΩ FAST	OVC	MENU
10.01211 mΩ	REF 10.0000 mΩ	STAT
+ 0.121 %	UPP +1.000 %	F 3
	LOW -1.000 %	

Displays the Calculation Results screen (if statistical calculation is enabled).

STATISTICS		RETURN
Num 19	Val 17	PRINT
Ave 99.5153Ω	Sn 0.0015Ω	UNDO
Max 99.5183Ω	Sn1 0.0015Ω	ALLCLR
(No:00015)	Cp 1.00	
Min 99.5113Ω	CpK 1.00	
(No:00001)		

- |            |                  |            |   |
|------------|------------------|------------|---|
| <b>Num</b> | Total data count | <b>Val</b> | Number of valid measured values (error-free data) |
| <b>Ave</b> | Mean             | <b>Sn</b>  | Population standard deviation                     |
| <b>Max</b> | Maximum          | <b>Sn1</b> | Standard deviation of sample                      |
| <b>Min</b> | Minimum          | <b>Cp</b>  | Process capability index (dispersion)             |
|            |                  | <b>Cpk</b> | Process capability index (bias)                   |

**2 To print**

To print, select the printer as the interface setting on the System screen (p. 85)

STATISTICS		RETURN
Num 19	Val 17	PRINT
Ave 99.5153Ω	Sn 0.0015Ω	F 2
Max 99.5183Ω	Sn1 0.0015Ω	
(No:00015)	Cp 1.00	
Min 99.5113Ω	CpK 1.00	
(No:00001)		

Output to the printer. "Example Printouts" (p. 87)

Statistical calculation results and stored data are erased when printing finishes.

**To erase**

STATISTICS		RETURN
Num 19	Val 17	UNDO
Ave 99.5153Ω	Sn 0.0015Ω	F 3
Max 99.5183Ω	Sn1 0.0015Ω	ALLCLR
(No:00015)	Cp 1.00	F 4
Min 99.5113Ω	CpK 1.00	
(No:00001)		

- F 3 Erases the last measurement and calculation result (executes only once).
- F 4 Erases all measured values and statistical calculation results.

After selecting, a confirmation screen appears.

## 6.4 Auto-Exporting Measured Values (at End of Measurement) (Data Output Function)

At the end of measurement, the measured value is exported to a computer via RS-232C.

See: "Chapter 9 Communications (RS-232C/ GP-IB Interface)" (p. 101)

### NOTE

- Set the interface to [RS232C] beforehand. This function is not applicable to the GP-IB Interface.  
See: "9.4 Configuring the Communications Protocol" (p. 105)
- When internal (INT) triggering is selected, data is exported only when a  $\overline{\text{TRIG}}$  signal is applied.
- Executing a :READ? query command exports duplicate measured values.
- For other queries, be careful to avoid overlapping query response timing with auto-exporting measured values.
- The data format for measured values can be selected as ASCII (default) or BINARY. Transfer time is minimized when BINARY is selected.

See: ".SYSTEM:FORMat <ASCIi/ BINary>" (p. 141)

### 1 Open the Basic Settings screen.

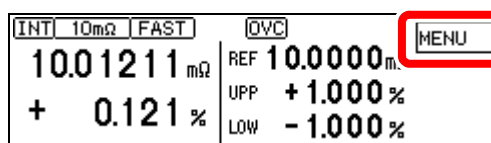

F 1

The Basic Settings screen appears.

### 2 Open the Data Memory Settings screen.

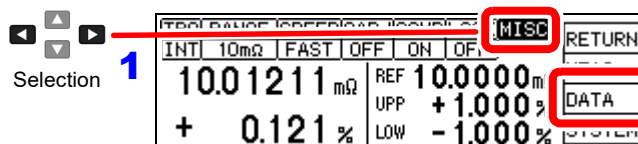

Selection

2

F 3

The Data Settings screen appears.  
[DATA SETTINGS]

### 3 Enable or disable auto-exporting (DATA OUT)

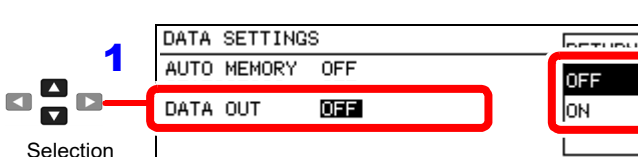

Selection

2

F 2

Disable auto-exporting (default)

F 3

Enable auto-exporting

### 4 Return to the Measurement screen.

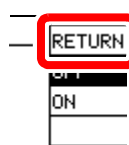

The confirmation screen appears.

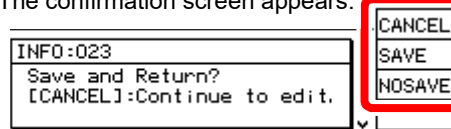

F 1

Return to the setting screen.

F 2

Save setting and return to previous screen.

F 3

Discard setting and return to previous screen.





# Printing

# Chapter 7

Connecting the printer to the instrument

Make instrument settings (p. 85)

Make printer settings

## Printing (p. 86)

- Measurement values and comparator decisions
- Statistical calculation results

## 7.1 Connecting the Printer

### Before connecting the printer

#### **WARNING**

Because electric shock and instrument damage hazards are present, always follow the steps below when connecting the printer.

- Always turn off the instrument and the printer before connecting.
- A serious hazard can occur if a wire becomes dislocated and contacts another conductor during operation. Make certain connections are secure.

#### **NOTE**

- As much as possible, avoid printing in hot and humid environments. Otherwise, printer life may be severely shortened.
- Use only compatible recording paper in the printer. Using non-specified paper may not only result in faulty printing, but printing may become impossible.
- If the recording paper is skewed on the roller, paper jams may result.

### Recommended printer

The requirements for a printer to be connected to the instrument are as follows. Confirm compatibility and make the appropriate settings on the printer before connecting it to the instrument.

See: "7.2 Instrument Settings" (p. 85)

- Interface ..... RS-232C
- Characters per line ..... At least 45
- Communication speed..... 9600 bps
- Data bits ..... 8
- Parity ..... none
- Stop bits ..... 1
- Flow control ..... none
- Control codes ..... Capable of directly printing plain text

### Connecting the Printer to the Instrument

#### Connection Methods

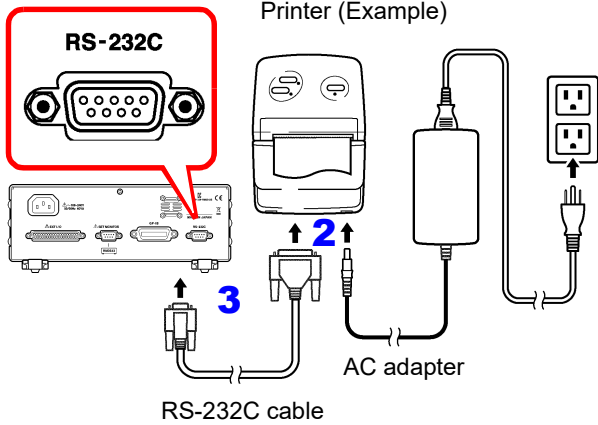

- 1** Confirm that the instrument and printer are turned off.
- 2** Connect the AC adapter to the printer, and insert the power plug into an outlet.
- 3** Connect the RS-232C cable to the RS-232C connectors on the instrument and printer.
- 4** Turn the instrument and printer on.

#### Connector Pinouts

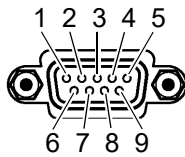

RM3543 (9-pin) Connector

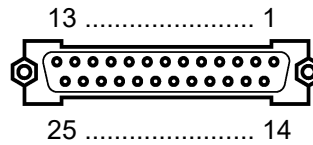

Printer (25-pin) Connector (Example)

Function	Signal Name	Pin
Receive Data	RxD	2
Transmit Data	TxD	3
Signal or Common Ground	GND	5

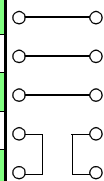

Pin	Signal Name	Function
2	TxD	Transmit Data
3	RxD	Receive Data
7	GND	Signal or Common Ground
4	RTS	Request to Send
5	CTS	Clear to Send

## 7.2 Instrument Settings

### 1 Open the Basic Settings screen.

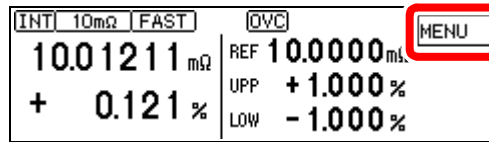

F 1

The Basic Settings screen appears.

### 2 Open the System screen.

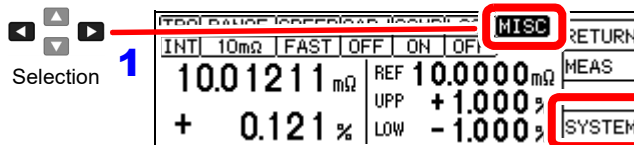

Selection

1

2

F 4

The System screen appears.  
[SYSTEM]

### 3 Select PRINT as the interface type.

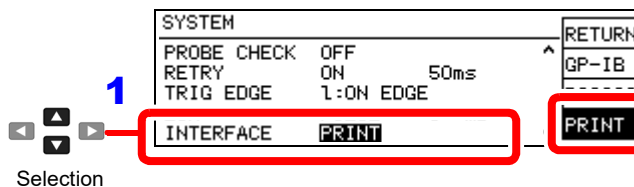

Selection

1

2

F 4

To use the printer

### 4 Return to the Measurement screen.

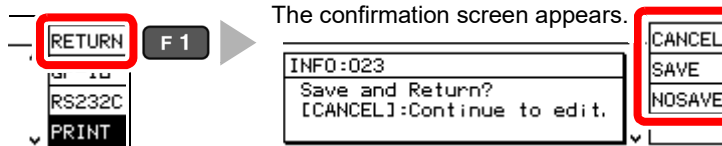

RETURN

F 1

The confirmation screen appears.

CANCEL

F 1

SAVE

F 2

NOSAVE

F 3

Return to the setting screen.  
Save setting and return to previous screen.  
Discard setting and return to previous screen.

## 7.3 Printing

### Before Printing

Verify that the instrument and printer settings (p. 85) are correct.

### Printing Measured Values and Comparator Decisions

#### Printing by key operation

Press the **PRINT** key to print the measured value currently displayed on the Measurement screen.

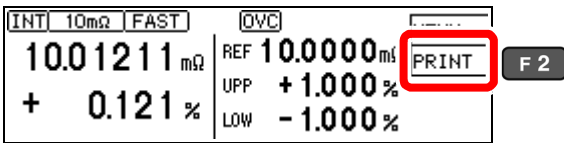

#### Printing by external control

Measured values and comparator decisions print when the (active-low)  $\overline{\text{PRINT}}$  signal (EXT I/O connector) is connected to ISO\_GND.\*

\* ISO\_GND is a pin in the instrument's EXT I/O connector.

#### NOTE

When statistical calculation is enabled [STATISTIC: ON] and internal triggering [TRG: INT] is selected, statistical calculations are performed and measured values are printed. When external (EXT) triggering is selected, only measured values are printed. Use the TRIG signal to perform statistical calculations with external triggering.

### Printing Statistical Calculation Results

Statistical calculation results can be printed when auto-memory or statistical calculation is enabled (ON). To print, select PRINT on the screen or connect the (active-low)  $\overline{\text{PRINT}}$  signal on the EXT I/O connector to ISO\_GND.

#### To enable auto-memory:

See: "6.2 Store as soon as Measurement is Stable (Auto-Memory Function)" (p. 75)

#### To enable statistical calculation:

See: "6.3 Performing Statistical Calculations on Measured Values" (p. 78)

(When statistical calculation is enabled)

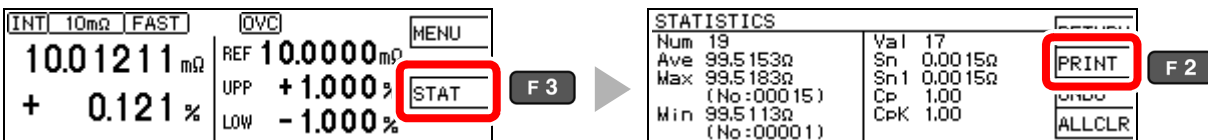

If no valid data exists, only the data count is printed. When only one valid data sample exists, standard deviation of sample and process capability indices cannot be printed.

**Example Printouts****Resistance measurements**

```

1    0.8725mOhm Lo
2    0.484mOhm Lo
3   10.99998 Ohm IN
4   -10.0026 Ohm Lo
27   9.9986 Ohm Hi
28   9.996 Ohm Hi
29   0.01003 Ohm Hi
30   0.00012 Ohm Hi

```

**Measurement fault values**

```

1    OvrRng      Hi
2   -OvrRng      Lo
3    C.E.Hi      --
4    C.E.Lo      --
5    C.E.Volt    --
6    -----    --

```

**Auto-memory data and statistical calculation results**

```

Date: 11-02-01   Time: 06:18:00
Ref: 1000.000 Ohm Upp: +1.000% Low: -1.500%
1    999.885 Ohm  -0.011% IN
2   1001.885 Ohm  +0.189% IN
3   1002.394 Ohm  +0.239% IN
4   1002.892 Ohm  +0.289% IN
5   1012.894 Ohm  +1.289% Hi
6   1000.897 Ohm  +0.090% IN
7    998.902 Ohm  -0.110% IN
8    994.888 Ohm  -0.511% IN
9   1000.391 Ohm  +0.039% IN
10  979.892 Ohm  -2.011% Lo
Hi:   1  IN:   8  Lo:   1  OR:   0
Number: 10  Valid: 10
Max  1012.894 Ohm  +1.289% ( 5)
Min   979.892 Ohm  -2.011% ( 10)
Avg   999.492 Ohm  -0.051%
Sn    7.83568 Ohm
Sn-1  8.25953 Ohm
Cp    0.50
CpK   0.42

```

- The “Valid” statistical calculation result indicates the number (count) of data samples not subject to errors such as measurement faults.
- Among the comparator decision result counts (Hi, IN, Lo, and OR), “OR” indicates the number (count) of out-of-range measurements.



# External Control Chapter 8

The EXT I/O connector on the rear of the instrument supports external control by providing output of the end-of-measurement and comparator decision signals, and accepting input of measurement trigger and key-lock signals. All signals are isolated by optocouplers (inputs and outputs share a common signal ground).

Confirm input and output ratings, understand the safety precautions for connecting a control system, and use accordingly.

Connect the instrument's EXT I/O connector to the signal output or input device.

Make instrument settings (p. 97)

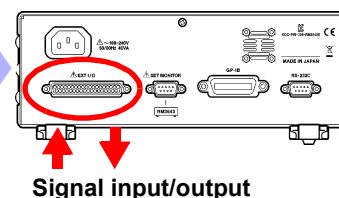

## 8.1 External Input/Output Connector and Signals



### **WARNING**

To avoid electric shock or damage to the equipment, always observe the following precautions when connecting to the EXT I/O terminals.

- Always turn off the power to the instrument and to any devices to be connected before making connections.
- Be careful to avoid exceeding the ratings of external terminals (p. 95).
- During operation, a wire becoming dislocated and contacting another conductive object can be serious hazard. Use screws to secure the external connectors.
- Ensure that devices and systems to be connected to the EXT I/O terminals are properly isolated.
- The ISO\_5V pin of the EXT I/O connector is a 5 V power output, and the ISO\_12V pin is a 12 V power output. Do not apply external power to this pin.

### **CAUTION**

To avoid damage to the instrument, observe the following cautions:

- Do not apply voltage or current to the EXT I/O terminals that exceeds their ratings.
- When driving relays, be sure to install diodes to absorb counter-electromotive force.
- Be careful not to short-circuit ISO\_5V to ISO\_COM.
- Be careful not to short-circuit ISO\_12V to ISO\_COM.
- Do not draw loads from ISO\_5V and ISO\_12V at the same time.

See: "Connector Type and Signal Pinouts" (p. 90)

Connector Type and Signal Pinouts

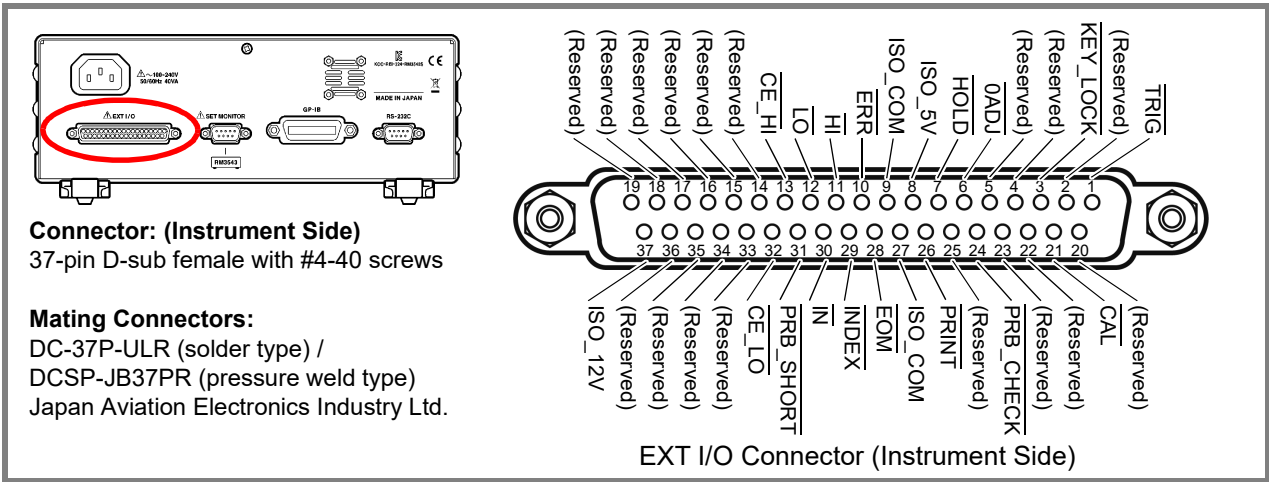

Pos: positive, Neg: negative, -: not applicable

Pin	Signal name	I/O	Function	Logic
1	TRIG	IN	External trigger	Pos/ Neg Edge
2	(Reserved)	-	-	- -
3	KEY_LOCK	IN	Key-Lock	Neg Level
4	(Reserved)	-	-	- -
5	(Reserved)	-	-	- -
6	OADJ	IN	Execute zero-adjust	Neg Edge
7	HOLD	IN	Enable external triggering	Neg Level
8	ISO_5V	-	Isolated 5 V power output	- -
9	ISO_COM	-	Isolated common signal ground	- -
10	ERR	OUT	Measurement fault	Neg Level
11	HI	OUT	HI comparator decision	Neg Level
12	LO	OUT	LO comparator decision	Neg Level
13	CE_HI	OUT	Probe (HI side) contact error	Neg Level
14	(Reserved)	-	-	- -
15	(Reserved)	-	-	- -
16	(Reserved)	-	-	- -
17	(Reserved)	-	-	- -
18	(Reserved)	-	-	- -
19	(Reserved)	-	-	- -

Pin	Signal name	I/O	Function	Logic
20	(Reserved)	-	-	- -
21	CAL	IN	Execute self-calibration	Neg Edge
22	(Reserved)	-	-	- -
23	(Reserved)	-	-	- -
24	PRB_CHECK	IN	Execute probe short-circuit detection	Neg Edge
25	(Reserved)	-	-	- -
26	PRINT	IN	Print measured value	Neg Edge
27	ISO_COM	-	Isolated common signal ground	- -
28	EOM	OUT	End of measurement	Neg Edge
29	INDEX	OUT	Analog measurement finished	Neg Edge
30	IN	OUT	IN comparator decision	Neg Level
31	PRB_SHORT	OUT	Probe short-circuit error	Neg Level
32	CE_LO	OUT	Probe (LO side) contact error	Neg Level
33	(Reserved)	-	-	- -
34	(Reserved)	-	-	- -
35	(Reserved)	-	-	- -
36	(Reserved)	-	-	- -
37	ISO_12V	-	Isolated 12 V power output	- -

Reserved pins are not connected inside the instrument. Do not connect to reserved pins.

**NOTE**

- The OADJ signal should be asserted (Low) for at least 10 ms.
- The connector shell is conductively connected to the metal instrument chassis and the protective earth pin of the power plug. Be aware that it is not isolated from ground.



## Signal Descriptions

## Input Signals

$\overline{\text{TRIG}}$	<p>When external triggering (EXT) is enabled, one measurement is performed at the falling (ON) or rising (OFF) edge of the <math>\overline{\text{TRIG}}</math> signal. Falling (ON) or rising (OFF) edge triggering can be selected on the Settings screen (default: falling (ON) edge).</p> <p>When internal triggering (INT) is enabled, external triggering is disabled. Also, when the Settings Monitor function is enabled and an error occurs, triggering is disabled (p. 56).</p> <p>The <math>\overline{\text{TRIG}}</math> signal performs the following operations in addition external triggering:</p> <ul style="list-style-type: none"> <li>• Stores statistical calculation data (when statistical calculation is enabled)</li> <li>• Stores measured data to internal memory (when the data memory function is enabled) (also operates with internal triggering)</li> </ul>	(p. 98)
$\overline{\text{0ADJ}}$	<p>Asserting the <math>\overline{\text{0ADJ}}</math> signal executes zero adjustment once.</p> <p>To avoid malfunction, this signal should be asserted (Low) for at least 10 ms.</p>	(p. 32)
$\overline{\text{PRINT}}$	<p>Asserting the <math>\overline{\text{PRINT}}</math> signal prints the current measurement value.</p>	(p. 86)
$\overline{\text{CAL}}$	<p>Asserting the <math>\overline{\text{CAL}}</math> signal executes self calibration. The time required for self calibration is as follows:</p> <p>Approximately 130 ms (with 60-Hz line frequency setting), or 110 ms (with 50-Hz setting)</p> <p>If asserted during measurement, executes after the end of measurement.</p>	(p. 60)
$\overline{\text{HOLD}}$	<p>Holding the <math>\overline{\text{HOLD}}</math> signal low enables external triggering. When the <math>\overline{\text{HOLD}}</math> signal is high, the settings made on the Settings screen or by commands are re-enabled.</p>	
$\overline{\text{PRB\_CHECK}}$	<p>Asserting the <math>\overline{\text{PRB\_CHECK}}</math> signal executes probe short-circuit adjustment one time. If asserted during measurement, executes after the specified time from the end of measurement.</p>	(p. 54)
$\overline{\text{KEY\_LOCK}}$	<p>While the <math>\overline{\text{KEY\_LOCK}}</math> signal is held low, all front panel keys (except POWER button) are disabled (key unlock and remote control cancellation operations are also disabled).</p>	(p. 63)

## Output Signals

$\overline{\text{ERR}}$	<p>This signal indicates that a measurement fault has occurred (except out-of-range detection). It is updated simultaneously with the <math>\overline{\text{EOM}}</math> signal. At this time, comparator decision outputs are all de-asserted (high).</p>	(p. 38)
$\overline{\text{CE\_HI}}$	<p>This signal indicates that a contact check error has occurred between <math>\text{H}_{\text{CUR}}</math> and <math>\text{H}_{\text{POT}}</math> contacts. It is updated simultaneously with the <math>\overline{\text{EOM}}</math> signal. At this time, comparator decision outputs are all de-asserted (high).</p>	(p. 49)
$\overline{\text{CE\_LO}}$	<p>This signal indicates that a contact check error has occurred between <math>\text{L}_{\text{CUR}}</math> and <math>\text{L}_{\text{POT}}</math> contacts. It is updated simultaneously with the <math>\overline{\text{EOM}}</math> signal. At this time, comparator decision outputs are all de-asserted (high).</p>	(p. 49)
$\overline{\text{PRB\_SHORT}}$	<p>This signal indicates that a foreign object is shorting the POT and CUR contacts in a four-terminal probe tip. At this time, comparator decision outputs are all de-asserted (high).</p>	(p. 54)
$\overline{\text{INDEX}}$	<p>This signal indicates that A/D conversion in the measurement circuit is finished.</p> <p>When the asserted (low) state occurs, the measurement sample can be removed.</p>	
$\overline{\text{EOM}}$	<p>This signal indicates the end of a measurement. At this time, the states of the comparator decision outputs and <math>\overline{\text{ERR}}</math>, <math>\overline{\text{CE\_HI}}</math>, <math>\overline{\text{CE\_LO}}</math>, and <math>\overline{\text{PRB\_SHORT}}</math> are all determined.</p>	(p. 97)
$\overline{\text{HI}}$ , $\overline{\text{IN}}$ , $\overline{\text{LO}}$	<p>These are the comparator decision output signals.</p>	

**NOTE**

- Input signals are ignored when the following are displayed: Basic, Detailed, and Comparator Settings screens; Statistical Calculation Results screen (except for the print signal); and error messages (except Setting Monitor errors).
- EXT I/O input and output signals are not usable while changing measurement settings.

## 8.2 Timing Chart

Each signal level indicates a corresponding voltage level.

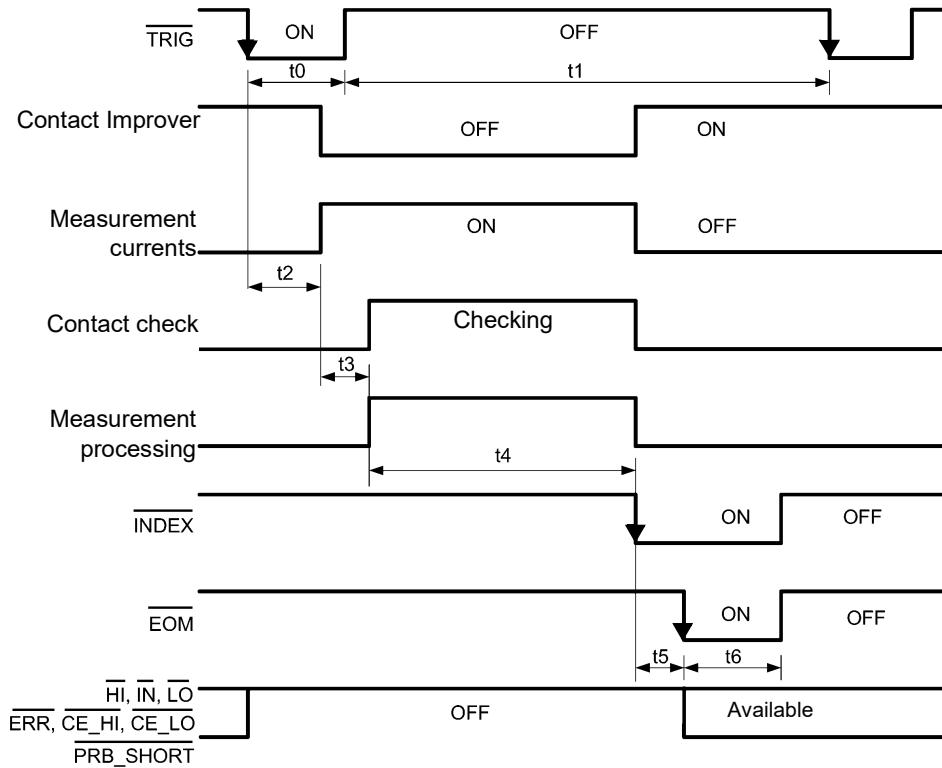

**NOTE**

- The  $\overline{EOM}$  signal is operational when the trigger source setting is EXT and the EOM output setting is Pulse.
- A self-calibration measurement (approximately 130 ms) is automatically performed every 10 minutes (between measurements).  $\overline{TRIG}$  signal input is accepted during that time, but the corresponding measurement is delayed until self-calibration is finished.
- Do not apply a  $\overline{TRIG}$  signal while measuring using external triggering (the signal is ignored).
- When changing settings such as measurement range, allow about 150 ms processing time before applying a  $\overline{TRIG}$  signal.
- Input signals are ignored when the following are displayed: Basic, Detailed, and Comparator Settings screens; Statistical Calculation Results screen (except for the print signal); and error messages (except Setting Monitor errors).
- The  $\overline{INDEX}$  and  $\overline{EOM}$  signals are de-asserted simultaneously.
- Output of comparator decisions and error signals are determined before the  $\overline{EOM}$  signal is asserted.
- With internal (INT) triggering, the  $\overline{EOM}$  signal is fixed High (OFF). Also, comparator decisions and error signals are not de-asserted (OFF) when measurement starts.
- When using the internal trigger [INT], the setting for the DELAY1 ( $t_2$ ) time is increased by 100 ms.

**EOM operation when the  $\overline{EOM}$  Output setting is Hold**

The  $\overline{EOM}$  signal is asserted (ON) at the end of measurement.

The  $\overline{EOM}$  signal continues to be asserted until measurement starts again with the next  $\overline{TRIG}$  signal input.

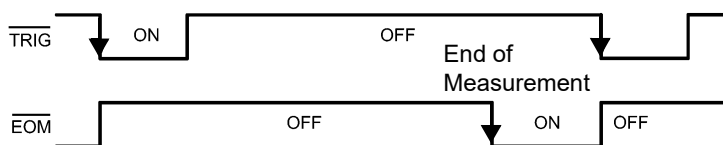

See: "Setting End-of-Measurement Signal Output (EOM Signal Setting)" (p. 97)

**NOTE**

The  $\overline{EOM}$  signal is de-asserted when the next measurement is started by the next  $\overline{TRIG}$  signal.

### Output Signal State at Power-On

All signals are low (asserted active-low) when power is turned on.  
All output signals become high (de-asserted active-low) when changing from the initial screen to the Measurement screen.

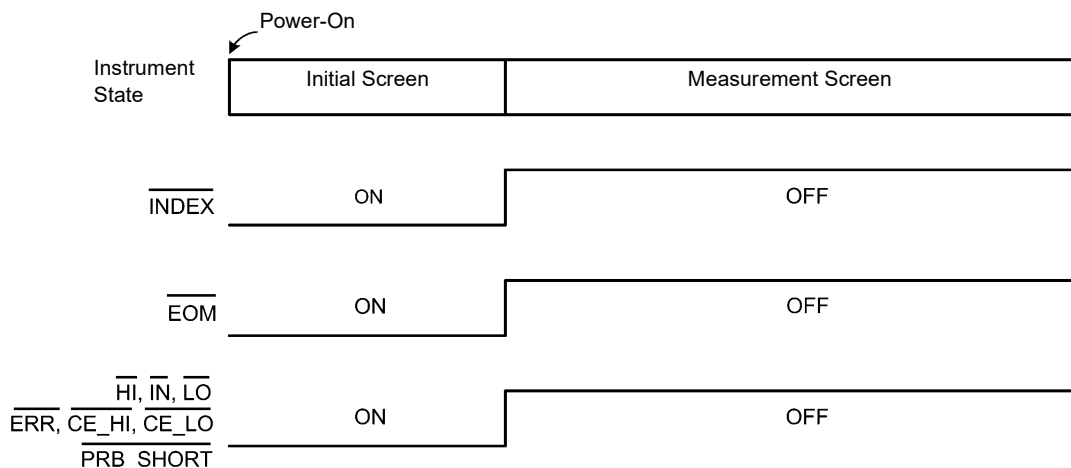

Operation is shown when the trigger source is set to external triggering (EXT).

### Timing Chart Interval Descriptions

Interval	Description	Duration	Remarks
t0	Trigger Pulse Asserted (ON)	0.1 ms or more	Falling (ON)-/rising (OFF)-edge selectable
t1	Trigger Pulse De-asserted (OFF)	0.1 ms or more	
t2	Delay 1	0 to 100 ms	Setting-dependent (when using the internal trigger, increased by 100 ms)
t3	Delay 2	0 to 100 ms	Setting-dependent (When the Contact Improver function is set to Pulse, 0.1 ms is added.)
t4 *1	Measurement time	0.1 to 100 ms	OVC OFF: Integration Time + Internal Delay (see following table) OVC ON: (Integration Time + Internal Delay) × 2 + Delay2
t5	Calculation time	0.1 ms	Calculation time is longer when memory storage is enabled.
t6	EOM pulse width	1 to 100 ms	Setting-dependent

\*1: When the averaging function is on, the processing (t3 + t4) (time) is repeated the set number of times.

### Internal Delay

Range	Internal Delay [ms]
10mΩ	3.5
100mΩ (1A)	1.6
100mΩ (100mA)	1.4
1000mΩ	0.7
10Ω	0.5
100Ω	0.5
1000Ω	0.5

# 8.3 Internal Circuitry

## Input Circuit

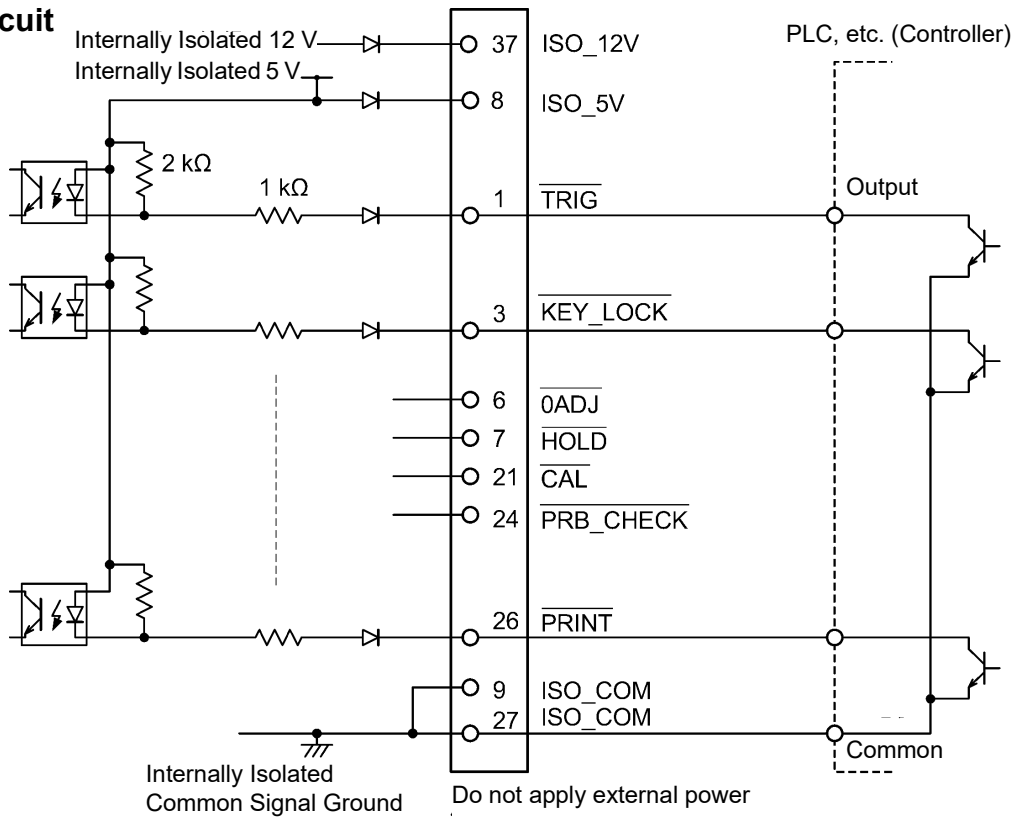

## Output Circuit

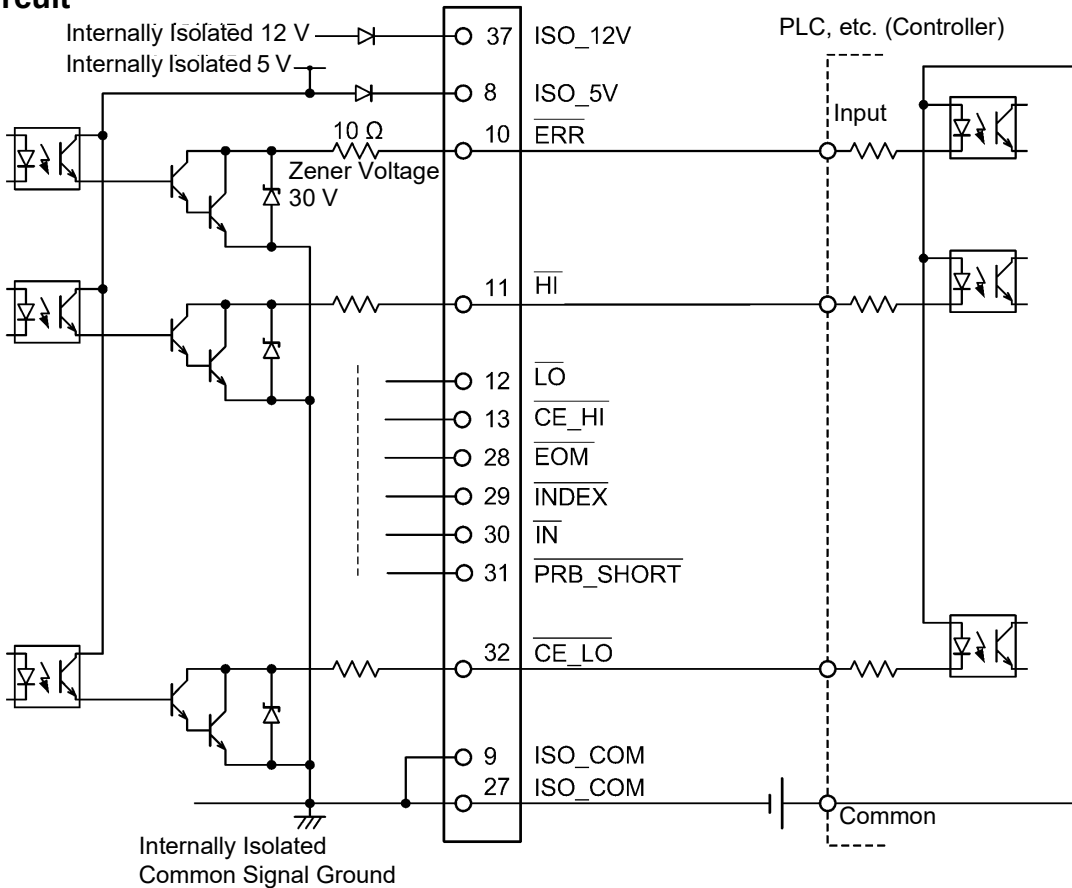

## Electrical Specifications

<b>Input Signals</b>	Input type	Optocoupler-isolated, non-voltage contact inputs (source input, active-low)
	Input asserted (ON) voltage	1 V or less
	Input de-asserted (OFF) voltage	Open or 5 to 30 V
	Input asserted (ON) current	3 mA/ch
	Maximum applied voltage	30 V
<b>Output Signals</b>	Output type	Optocoupler-isolated npn open-collector outputs (current sink, active-low)
	Maximum load voltage	30 V
	Maximum output current	50 mA/ch
	Residual voltage	1 V (10 mA), 1.5 V (50 mA)
<b>Internally Isolated Power Output</b>	+5 V power output	
	Output Voltage	4.5 to 5.0 V
	Maximum output current	100 mA
	+12 V power output	
	Output Voltage	11.0 to 13.0 V
	Maximum output current	20 mA
	External power input	none
<ul style="list-style-type: none"> <li>The maximum output current figures for the +5 V and +12 V power outputs assume standalone use. Do not draw loads from the power supplies at the same time.</li> </ul>		

Connection Examples

Input Circuit Connection Examples

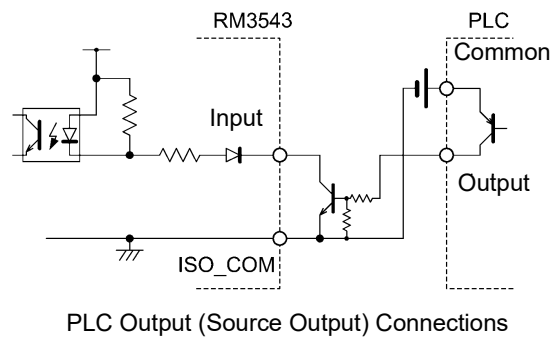
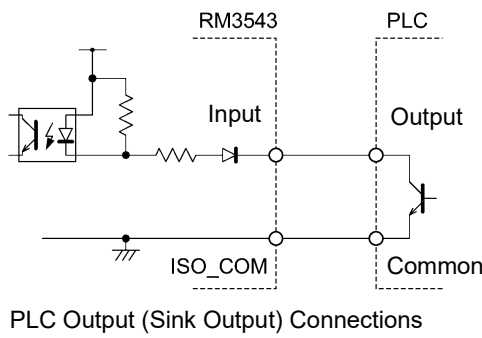
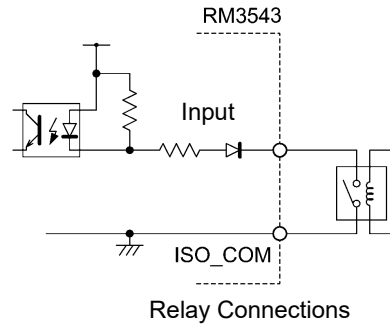
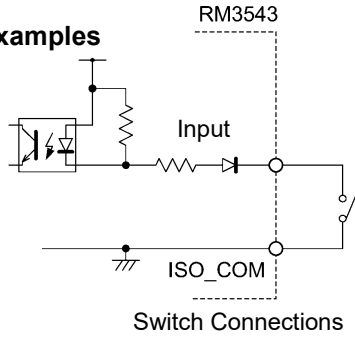

Output Circuit Connection Examples

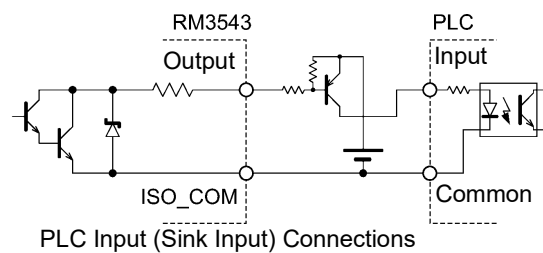
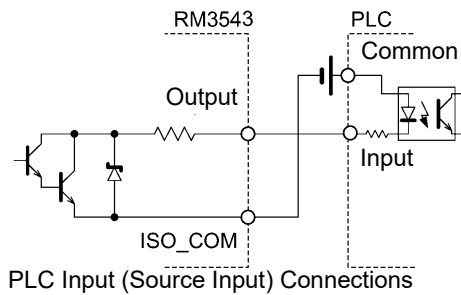
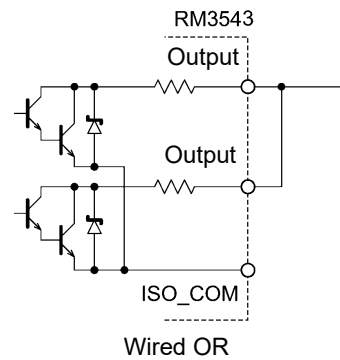
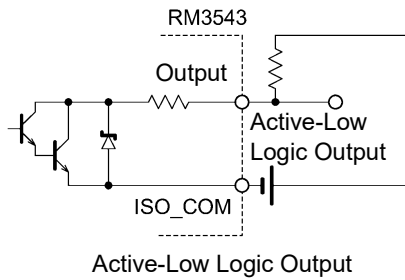
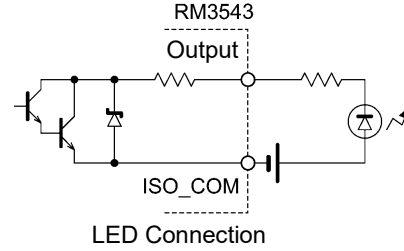
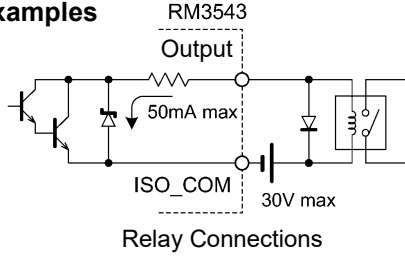

## 8.4 External I/O Settings

These settings affect the logic of the end-of-measurement and trigger signals.

### Setting End-of-Measurement Signal Output (EOM Signal Setting)

The selected EOM output level is retained until the next trigger input, or for the specified pulse width.

#### 1 Open the Basic Settings screen.



#### 2 Open the System screen.

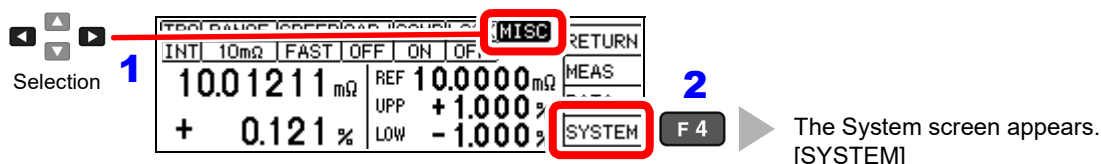

#### 3 Select the EOM signal output type.

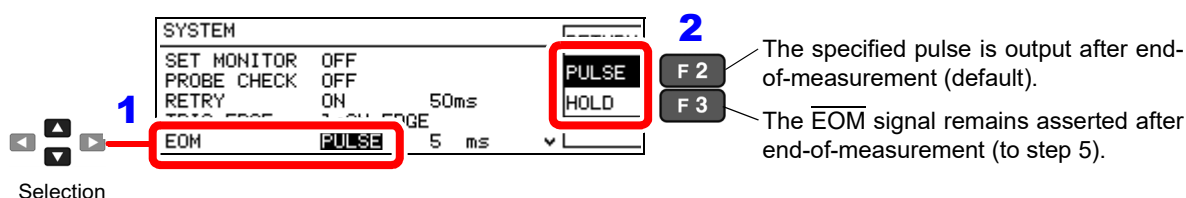

#### 4 (When PULSE is selected) Select the pulse width.

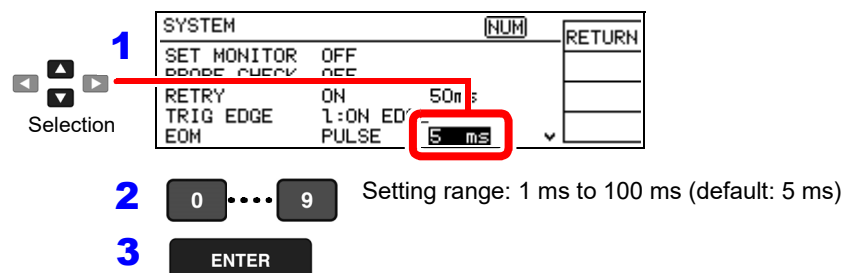

#### 5 Return to the Measurement screen.

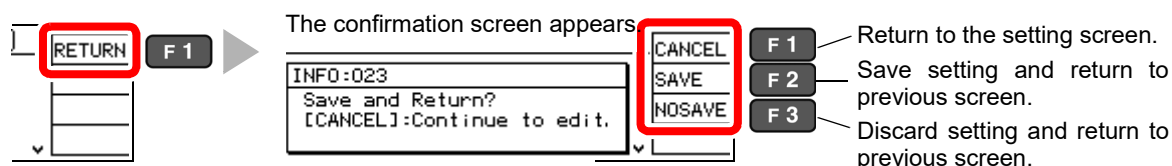

**Setting the Trigger (TRIG) Signal Logic**

Select whether triggering occurs on the falling (ON) or rising (OFF) edge.

**1** Open the Basic Settings screen.

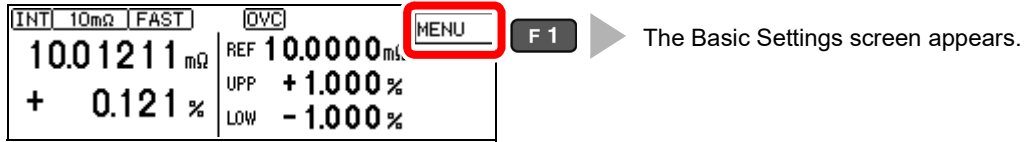

**2** Open the System screen.

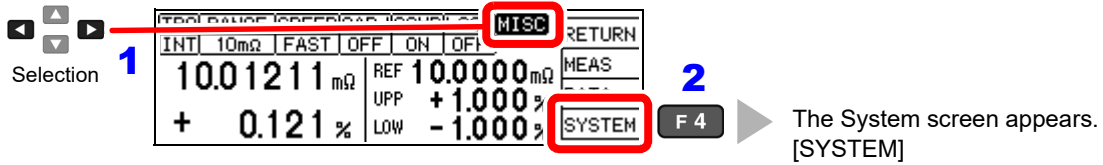

**3** Select the triggering logic edge.

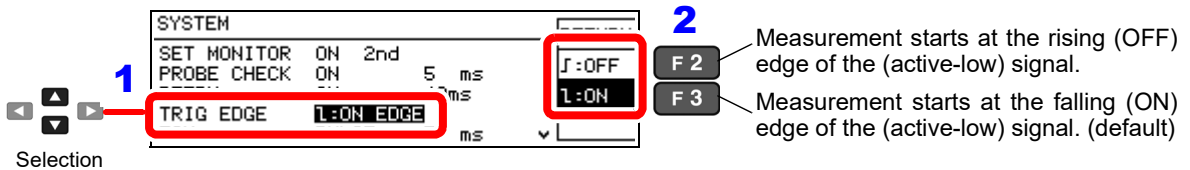

**4** Return to the Measurement screen.

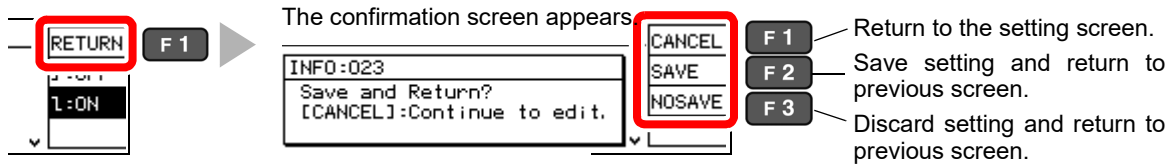



## 8.5 External Control Q&A

Common Questions	Answers
How do I connect external trigger input?	Connect the (active low) $\overline{\text{TRIG}}$ input pin to an ISO_COM pin using a switch or open-collector output.
Which pins are common ground for input and output signals?	The ISO_COM pins.
Are the common (signal ground) pins shared by both inputs and outputs?	Both common ground pins can be shared by inputs and outputs.
How do I confirm output signals?	Confirm voltage waveforms with an oscilloscope. To do this, the output pins such as $\overline{\text{EOM}}$ and comparator decision outputs need to be pulled up (through several k $\Omega$ ).
How do I troubleshoot input (control) signal issues?	For example, if triggering does not operate properly, bypass the PLC and short the TRIG pin directly to an ISO_COM pin. Be careful to avoid power shorts.
Are the comparator decision signals retained during measurement (or can they be off)?	The state is determined at the end of measurement, and is off once at the start of measurement.
Why would the $\overline{\text{EOM}}$ signal not be detected?	Try using the Pulse setting for $\overline{\text{EOM}}$ output. When the measurement time is short and $\overline{\text{EOM}}$ output is set to Hold, the time to de-assert may be too short to be detected by the PLC. When the $\overline{\text{EOM}}$ output is set to Pulse, the signal is asserted (ON) for the specified pulse width before turning off.
What situations cause measurement faults to occur?	An error is displayed in the following cases: <ul style="list-style-type: none"> <li>• A probe is not connected</li> <li>• A contact is unstable</li> <li>• A probe or measurement object is dirty or corroded</li> <li>• Measurement object resistance is much higher than the measurement range</li> </ul>
Is a connector or flat cable for connection provided?	A solder-type connector is supplied. The cable must be prepared at the user's side.
Is direct connection to a PLC possible?	Direct connection is supported for relay or open-collector outputs and positive-ground optocoupler inputs. (Before connecting, confirm that voltage and current ratings will not be exceeded.)
Can external I/O be used at the same time as RS-232C or other communications?	After setting up communications, it is possible to control measurement with the $\overline{\text{TRIG}}$ signal while acquiring measurement data via a communications interface.
How should external power be connected?	The instrument's external I/O input and output signals all operate from an internal isolated power source, so power must not be supplied from the PLC side.
Can free-running measured values be acquired using a footswitch?	Please use the free software for acquiring measured values available for download from our website.

## 8.6 Supplied Connector Assembly

The EXT I/O connector and shell are supplied with the instrument. Assemble as shown below.

### NOTE

- Use shielded cables to connect a PLC to the EXT I/O connector. Using non-shielded conductors may result in system errors from electrical noise.
- Connect the shield to the ISO\_COM pin of the EXT I/O connector.

#### Required tools:

- Screwdriver
- Shielded cable
- Soldering iron

#### Accessories

- **A** Cover .....2
- **B** Screws (+/-) #4-40UNC (16.9 mm overall length) .....2
- **C** Screws (+/-) #4-40UNC (12.6 mm overall length) .....2
- **D** Screws (-) #4-40UNC (15.0 mm overall length) .....2
- **E** Nuts #4-40UNC .....2
- **F** Cable Clamps .....2
- **G** Saddle Washers (shell protection) .....2
- **H** Connector .....1

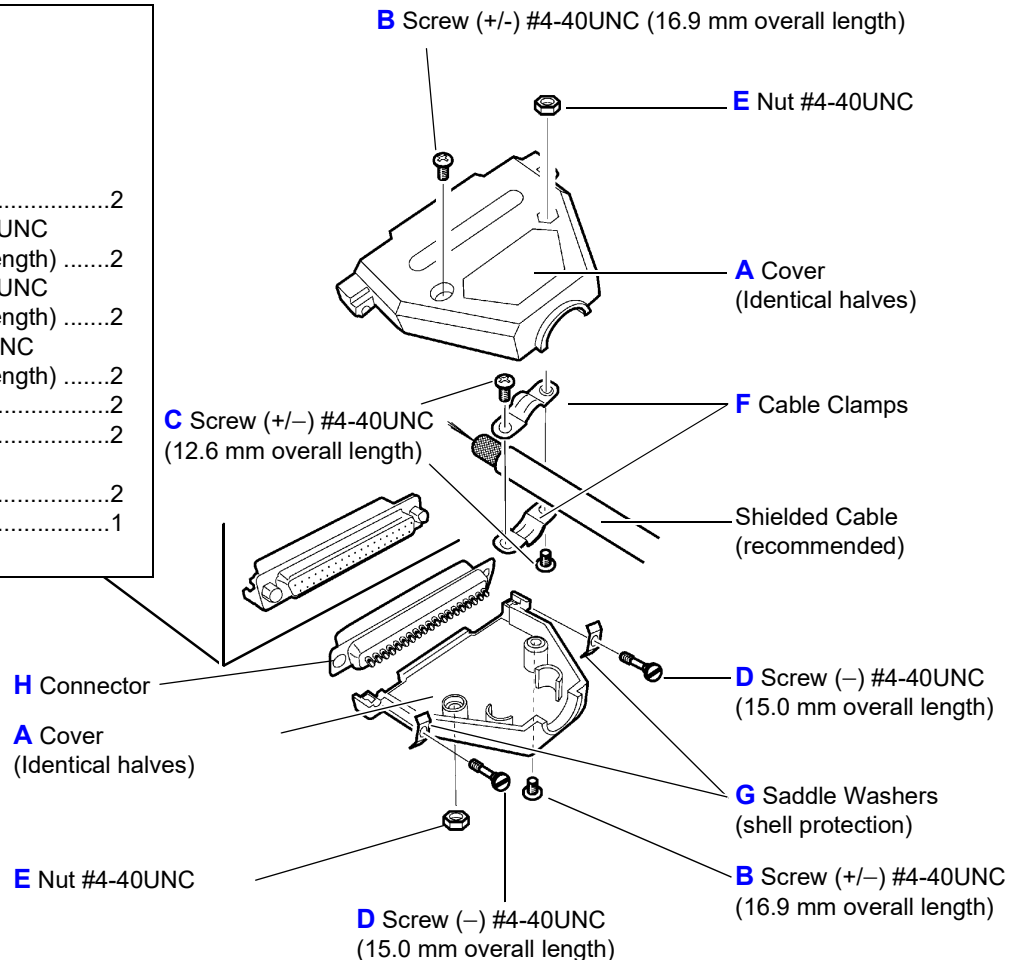

#### Assembly Sequence

1. Solder the (shielded) cable wires to the supplied EXT I/O connector (H) pins.
2. Affix the cable clamps (F) on the cable with screws (C).
3. Position the cable clamps (F) to fit properly inside the cover (A).
4. Insert screws (D) through the saddle washers (G).
5. In one half of cover (A), place connector (H), clamps (F), saddle washers (G) and screws (D).
6. Place the other half of cover (A) on top.
7. Affix the halves of the cover (A) together with screws (B) and nuts (E).

**Be careful not to overtighten the screws, which could damage the covers.**

# Communications (RS-232C/ GP-IB Interface)

## Chapter 9

The symbols shown below indicate that the following instructions are specific to the RS-232C or the GP-IB interface. Instructions without these symbols are for both the RS-232C and the GP-IB interface.

**RS-232C** : RS-232C only/ **GP-IB** : GP-IB only

### Before Use

- Always make use of the connector screws to affix the GP-IB or RS-232C connectors.
- When issuing commands that contain data, make certain that the data is provided in the specified format.
- External command operation is undetermined when the Printer is selected as the interface type. In this case, commands should not be sent.

**Wiring Diagram (p. 103)**  
Connect the Instrument and Controller with a GP-IB or RS-232C Interface Cable

### Communications Protocol Settings (p. 105)

- GP-IB** Entering an address
- RS-232C** Set the instrument to the same communications protocol as the controller
- Select the transmission format



## 9.1 Overview and Features

The instrument can be controlled by GP-IB or RS-232C. Instrument settings can also be reset.

**RS-232C** Using the RS-232C, the measurement values can be printed out by connecting the instrument to the commercially available printer with a serial interface (p. 83).

**GP-IB** IEEE 488.2-1987 standard (essential) commands can be used.

- Applicable standard IEEE 488.1-1987<sup>\*1</sup>
- Reference standard IEEE 488.2-1987<sup>\*2</sup>

If the output queue becomes full, a query error is generated and the output queue is cleared. Therefore, clearing the output queue and query error output from the deadlocked condition<sup>\*3</sup> as defined in IEEE 488.2 is not supported.

For details about the communications commands, see "Message Format" (p. 109) and "Message Reference Interpretation" (p. 126)

\*1. ANSI/IEEE Standard 488.1-1987, IEEE Standard Digital Interface for Programmable Instrumentation

\*2. ANSI/IEEE Standard 488.2-1987, IEEE Standard Codes, Formats, Protocols, and Common Commands

\*3. The situation in which the input buffer and the output queue become full, so that processing cannot continue.

## 9.2 Specifications

RS-232C and GP-IB communications cannot be used simultaneously.

### RS-232C Specifications

<b>Transfer method</b>	Communications: Full duplex Synchronization: Start-stop synchronization
<b>Baud rate</b>	9,600 bps/ 19,200 bps/ 38,400 bps
<b>Data length</b>	8 bits
<b>Parity</b>	none
<b>Stop bit</b>	1 bit
<b>Message terminator (delimiter)</b>	Receiving: CR or CR+LF Transmitting: CR+LF
<b>Flow control</b>	none
<b>Electrical specification</b>	Input voltage levels 5 to 15 V: ON, -15 to -5 V: OFF Output voltage levels 5 to 9 V: ON, -9 to -5 V: OFF
<b>Connector</b>	RS-232C Interface Connector Pinout (Male 9-pin D-sub, with #4-40 attachment screws) The I/O connector is a DTE (Data Terminal Equipment) configuration Recommended cables: Model 9637 RS-232C Cable (for PC) Model 9638 RS-232C Cable (for D-sub25pin connector)

Operating Code: ASCII codes

### GP-IB Specifications (Interface Functions) (RM3543-01 only)

<b>SH1</b>	All Source Handshake functions	●
<b>AH1</b>	All Acceptor Handshake functions	●
<b>T6</b>	Basic talker functions	●
	Serial poll function	●
	Talk-only mode	—
	The talker cancel function with MLA (My Listen Address)	●
<b>L4</b>	Basic listener functions	●
	Listen-only mode	—
	The listener cancel function with MTA (My Talk Address)	●
<b>SR1</b>	All Service Request functions	●
<b>RL1</b>	All Remote/Local functions	●
<b>PP0</b>	Parallel Poll function	—
<b>DC1</b>	All Device Clear functions	●
<b>DT1</b>	All Device Trigger functions	●
<b>C0</b>	No Controller functions	—

Operating Code: ASCII codes

## 9.3 Connecting



**WARNING** Always turn both devices OFF when connecting and disconnecting an interface connector. Otherwise, an electric shock accident may occur.



- To avoid damage to the instrument, do not short-circuit the terminal and do not input voltage to the terminal.
- If the connectors are not securely mated, operation may fail to meet specifications, and damage could result.
- To avoid damage, do not disconnect the communications cable while the instrument is sending or receiving data.
- Use a common ground for both the instrument and the computer.
- Using different ground circuits will result in a potential difference between the instrument's ground and the computer's ground.
- If the communications cable is connected while such a potential difference exists, it may result in equipment malfunction or failure.
- Before connecting or disconnecting any communications cable, always turn off the instrument and the computer. Failure to do so could result in equipment malfunction or damage. After connecting the communications cable, tighten the screws on the connector securely. Failure to secure the connector could result in equipment malfunction or damage.

### Using the RS-232C Interface

Connect the RS-232C cable to the RS-232C connector.

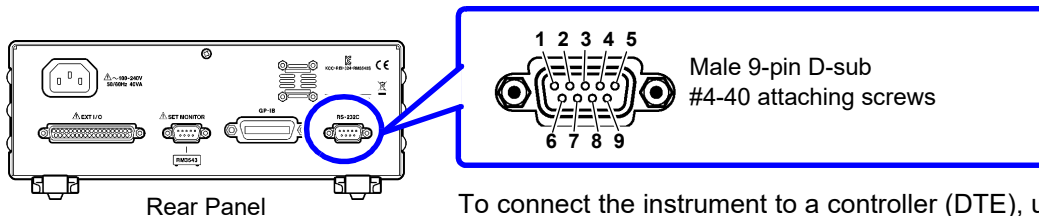

To connect the instrument to a controller (DTE), use a crossover cable compatible with the connectors on both the instrument and the controller.

The I/O connector is a DTE (Data Terminal Equipment) configuration. This instrument uses only pins 2, 3, and 5. The other pins are unconnected.

Pin No	Signal Name	Code Addr.		Mutual connection circuit name	Remarks
		EIA	JIS		
1	DCD	CF	CD	Carrier Detect	Not used
2	RxD	BB	RD	Receive Data	
3	TxD	BA	SD	Transmit Data	
4	DTR	CD	ER	Data Terminal Ready	Active (ON) level is +5 to +9 V (constant)
5	GND	AB	SG	Signal Ground	
6	DSR	CC	DR	Data Set Ready	Not used
7	RTS	CA	RS	Request to Send	Active (ON) level is +5 to +9 V (constant)
8	CTS	CB	CS	Clear to Send	Not used
9	RI	CE	CI	Ring Indicator	Not used

## 9.3 Connecting

### Connecting a controller with a 9-pin D-sub male port

Use a crossover cable with female 9-pin D-sub connectors.

#### Crossover Wiring

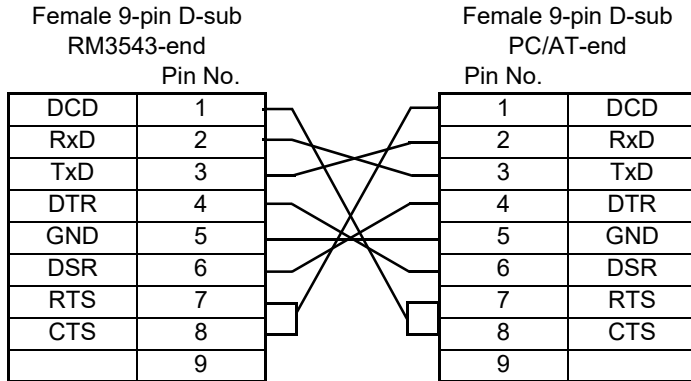

Recommended cable: HIOKI Model 9637 RS-232C Cable (1.8 m)

### Connecting a controller with a 25-pin D-sub female port

Use a crossover cable with a female 9-pin D-sub and a male 25-pin D-sub connector.

As the figure shows, RTS and CTS pins are shorted together and crossed to DCD in the other connector.

#### Crossover Wiring

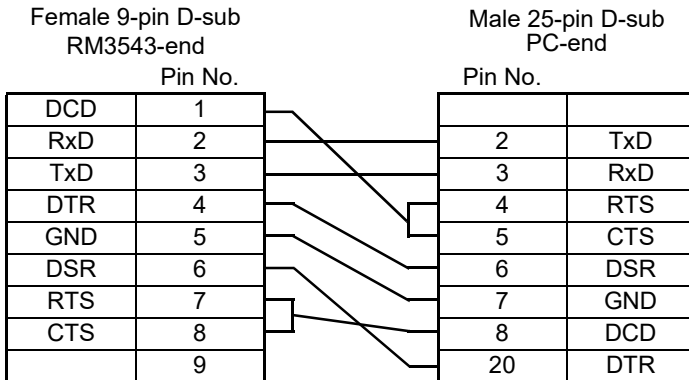

Note that the combination of a dual male 25-pin D-sub cable and a 9- to 25-pin adapter cannot be used.

Recommended cable: HIOKI Model 9638 RS-232C Cable

### Using the GP-IB Interface (RM3543-01 only)

Connect the GP-IB cable to the GP-IB connector.

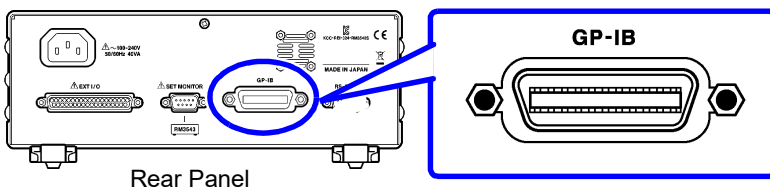

Recommended cable:  
HIOKI Model 9151-02 GP-IB Connector  
Cable (2 m)

## 9.4 Configuring the Communications Protocol

### Configuring RS-232C Interface Communications

Configure the interface on the System screen.

External command operation is undetermined when the Printer is selected as the interface type. In this case, commands should not be sent.

Make these instrument settings.

#### 1 Open the Basic Settings screen.

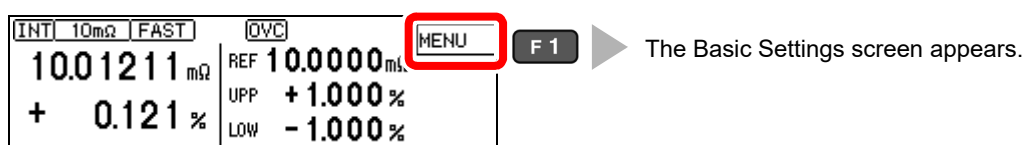

#### 2 Open the System screen.

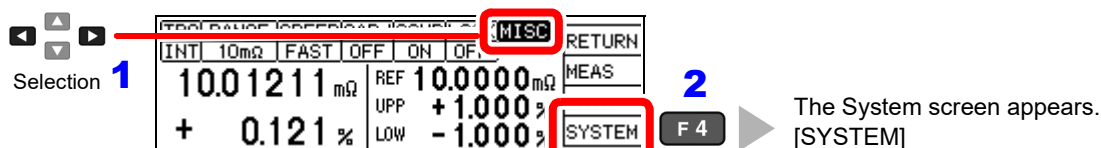

#### 3 Select the interface type.

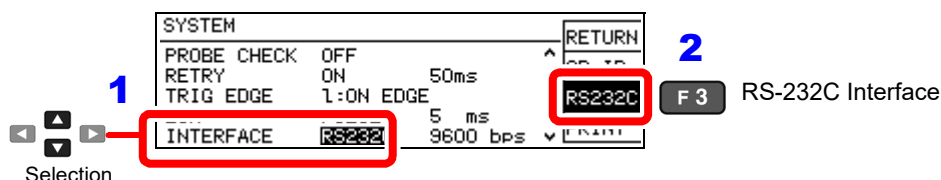

#### 4 Select the interface transfer rate.

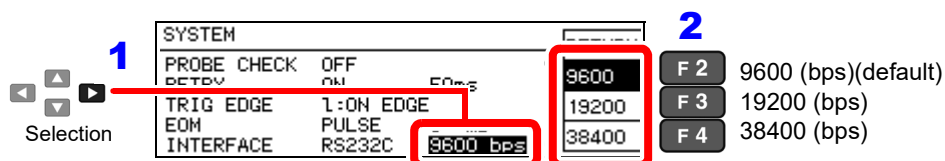

#### 5 Return to the Measurement screen.

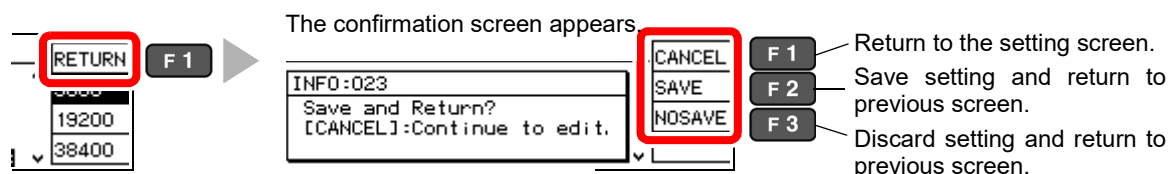

#### Configure the controller (PC or PLC).

Be sure to make set up the controller as shown below.

- Asynchronous communication
- Transfer rate: 9600bps/ 19200bps/ 38400bps (set to match the instrument setting)
- Stop bit: 1
- Data length: 8
- Parity check: None

**Configuring GP-IB Interface Communications (RM3543-01 only)**

Set the GP-IB address and message terminator on the System screen.

**1** Open the Basic Settings screen.

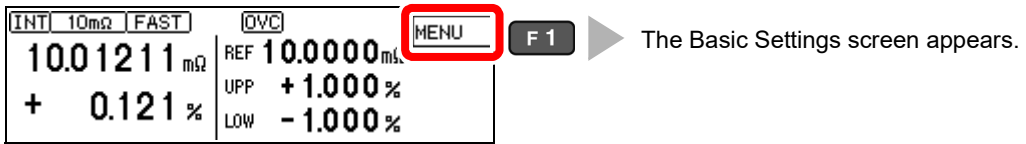

**2** Open the System screen.

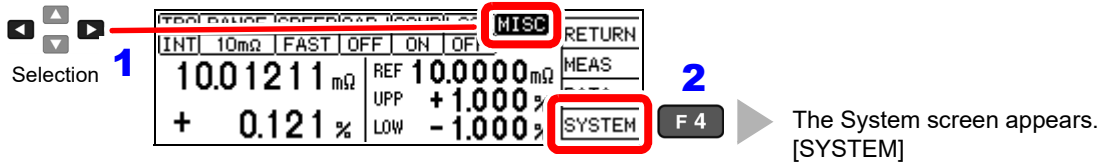

**3** Select the interface type.

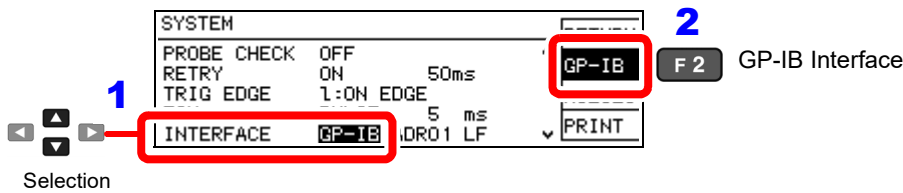

**4** Select the instrument's address.

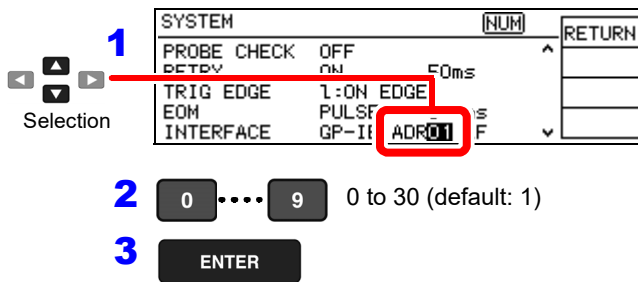

**2** 0 ..... 9 0 to 30 (default: 1)

**3** ENTER

**5** Select the interface message terminator.

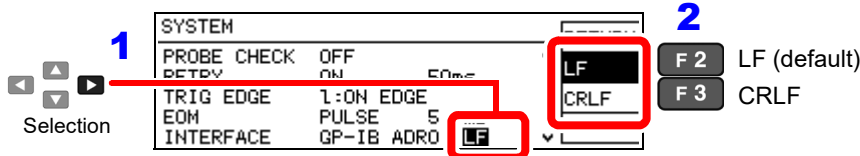

**6** Return to the Measurement screen.

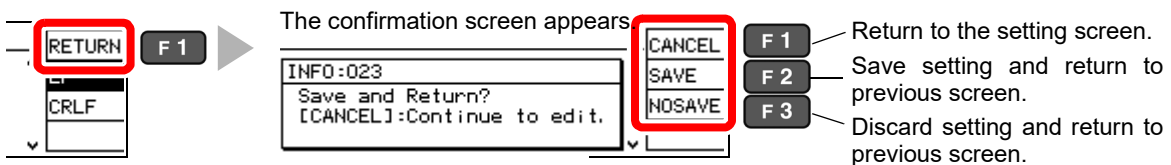

**NOTE**

“GP-IB” is only displayed on model RM3543-01 (equipped with GP-IB).



## Select the Measurement Data Transmission Format (both RS-232C and GP-IB)

Use communications commands to set the measurement data transmission format to ASCII or binary.

See: ":SYSTem:FORMat <ASCIi/ BINary>" (p. 141)

This setting applies only to data sent in response to the following query messages:

- **:FETCh?**
- **:READ?**
- **:MEMory:DATA?**

It also applies to data output sent by the measurement output functions.

### Binary Data Format

Binary data is IEEE format single-precision (32-bit) floating-point values.

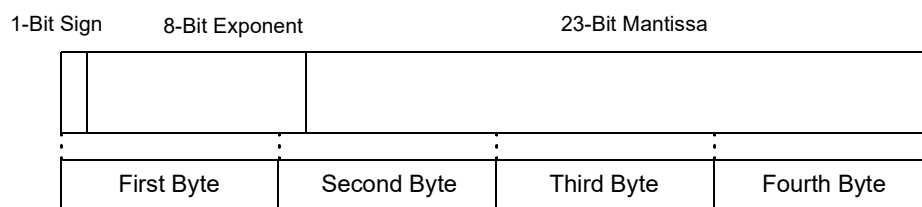

Binary data is sent in four-byte sequences beginning with the first byte (which includes the sign bit).

Responses to queries that return a single value, such as :FETCh?, consist of a measured value as four-byte floating-point binary data. The delimiter is not sent.

Example

Transmit **:FETCh?** + (terminator)

Receive (4-byte floating-point data)

Responses containing multiple values such as memory data consist of a continuous stream of binary data values with no punctuation or other separator between values.

Example

Transmit **:MEMory:DATA?** + (terminator)

Receive (4-byte floating-point data) + (4-byte floating-point data) + .... + (4-byte floating-point data)

## 9.5 Communication Methods

Various messages are supported for controlling the instrument through the interfaces. Messages can be either program messages, sent from the controller such as PC to the instrument, or response messages, sent from the instrument to the controller.

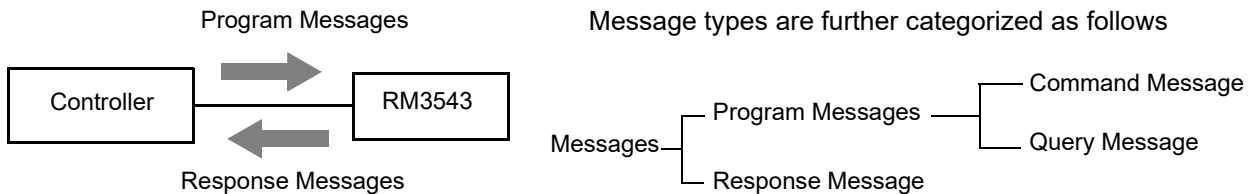

When issuing commands that contain data, make certain that the data is provided in the specified format.

### To cancel the Remote state (enter the local state)

During remote control operation, RMT appears on the Measurement screen, and all except the **F1** key are disabled.

Pressing the **F1** [LOCAL] key disables remote control and re-enables the operating keys.

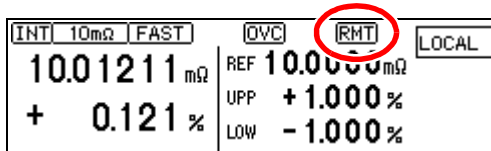

In the local lockout state (GP-IB command LLO: Local Lock Out, (p. 118)) selecting [LOCAL] on the screen has no effect. In this state, send the GTL command, or turn the instrument off and back on to re-establish local control. If the Setting screen was displayed when remote control was enabled, the instrument returns to the Measurement screen automatically.

## Message Format

### ■ Program Messages

Program messages can be either Command Messages or Query Messages.

#### (1) Command Messages

Instructions to control the instrument, such as to change settings or reset

Example: (instruction to set the measurement range)

```
:RESISTANCE:RANGE 100E-3
```

↑
↑
↑  
 Header portion      Space      Data portion

#### (2) Query Messages

Requests for responses relating to results of operation or measurement, or the state of instrument settings.

Example: (request for the current measurement range)

```
:RESISTANCE:RANGE?
```

↑
↑  
 Header portion      Question Mark

For details:

See: "Headers" (p. 110), "Separators" (p. 111), "Data Formats" (p. 111)

### ■ Response Messages

When a query message is received, its syntax is checked and a response message is generated. The `":SYSTEM:HEADER"` command determines whether headers are prefixed to response messages.

```
Header ON      :RESISTANCE:RANGE 100.0000E-03  
Header OFF     100.0000E-03  
(the current resistance measurement range is 100 mΩ)
```

At power-on, Header OFF is selected.

If an error occurs when a query message is received, no response message is generated for that query.

No header is applied to commands used only for queries, such as `:FETCH?` and `:CALCulate:LIMit:RESult?`.

### ■ Command Syntax

Command names are chosen to mnemonically represent their function, and can be abbreviated. The full command name is called the "long form", and the abbreviated name is called the "short form".

The command references in this manual indicate the short form in upper-case letters, extended to the long form in lower case letters, although the commands are not case-sensitive in actual usage.

```
FUNCTION    OK (long form)  
FUNC        OK (short form)  
FUNCT      Error  
FUN         Error
```

Response messages generated by the instrument are in long form and in upper case letters.

## ■ Headers

Headers must always be prefixed to program messages.

### (1) Command Program Headers

There are three types of commands: Simple, Compound and Standard.

- **Headers for Simple Commands**

This header type is a sequence of letters and digits

**:ESE 0**

- **Headers for Compound Commands**

These headers consist of multiple simple command type headers separated by colons “.”

**:SAMPLE:RESet**

- **Headers for Standard Commands**

This header type begins with an asterisk “\*”, indicating that it is a standard command defined by IEEE 488.2.

**\*RST**

### (2) Query Program Header

These commands are used to interrogate the instrument about the results of operations, measured values and the current states of instrument settings.

As shown by the following examples, a query is formed by appending a question mark “?” after a program header.

**:FETCh?**

**:CALCulate:LIMit:REFerence?**

### NOTE

Characters within square brackets [ ] may be omitted.

**[ :SENSE:]FUNCTION** → **:SENSE:FUNCTION**      Either form is valid  
**:FUNCTION**

## ■ Message Terminators

This instrument recognizes the following message terminators:

#### **GP-IB**

- LF
- CR+LF
- EOI
- LF with EOI

#### **RS-232C**

- CR
- CR+LF

From the instrument's interface settings, the following can be selected as the terminator for response messages.

#### **GP-IB**

- LF with EOI (initial setting)
- CR+LR with EOI

#### **RS-232C**

- CR+LF

See: "Delimiter Setting" (p. 139)

## ■ Separators

### (1) Message Unit Separator

Multiple message can be written in one line by separating them with semicolons “;”

```
:SYSTEM:LFREQUENCY 60;*IDN?
```

- When messages are combined in this way and if one command contains an error, all subsequent messages up to the next terminator will be ignored.
- A query error occurs if a query command is combined with an immediately following semicolon and subsequent command.

### (2) Header Separator

In a message consisting of both a header and data, the header is separated from the data by a space “ ” (ASCII code 20H).

```
:SYSTEM:HEADER OFF
```

### (3) Data Separator

In a message containing multiple data items, commas are required to separate the data items from one another.

```
:CALCULATE:LIMIT:ABS 1.00035,0.99965
```

## ■ Data Formats

The instrument uses character data and decimal numeric data, depending on the command.

### (1) Character Data

Character data always begins with an alphabetic character, and subsequent characters may be either alphabetic or numeric. Character data is not case-sensitive, although response messages from the instrument are only upper case.

```
:SYSTEM:HEADER OFF
```

### (2) Decimal Numeric Data

Three formats are used for numeric data, identified as NR1, NR2 and NR3. Numeric values may be signed or unsigned. Unsigned numeric values are handled as positive values. Values exceeding the precision handled by the instrument are rounded to the nearest valid digit.

- NR1 Integer data (e.g.: +12, -23, 34)
- NR2 Fixed-point data (e.g.: +1.23, -23.45, 3.456)
- NR3 Floating-point exponential representation data (e.g.: +1.0E-2, -2.3E+4)

The term “NRf format” includes all three of the above numeric decimal formats.

The instrument accepts NRf format data.

The format of response data is specified for each command, and the data is sent in that format.

```
:ESE0 106
:FETCH?
+106.571
```



The instrument does not fully support IEEE 488.2. As much as possible, please use the data formats shown in the Reference section.

Also, be careful to avoid constructing single commands that could overflow the input buffer or output queue.

## ■ Compound Command Header Omission

When several commands having a common header are combined to form a compound command (e.g., `:CALCulate:LIMit:REFeRence` and `:CALCulate:LIMit:PERCent`), if they are written together in sequence, the common portion (here, `:CALCulate:LIMit:`) can be omitted after its initial occurrence.

This common portion is called the “current path” (analogous to the path concept in computer file storage), and until it is cleared, the interpretation of subsequent commands presumes that they share the same common portion.

This usage of the current path is shown in the following example:

### Full expression

```
:CALCulate:LIMit:REFeRence
1.0E+3;:CALCulate:LIMit:PERCent 1.0,-1.5
```

### Compacted expression

```
:CALCulate:LIMit:REFeRence 1.0E+3;PERCent 1.0,-1.5
```

↑  
This portion becomes the current path, and can be omitted from the messages immediately following.

The current path is cleared when the power is turned on, when reset by key input, by a colon “:” at the start of a command, and when a message terminator is detected.

Standard command messages can be executed regardless of the current path.

They have no effect upon the current path.

A colon “:” is not required at the start of the header of a Simple or Compound command. However, to avoid confusion with abbreviated forms and operating mistakes, we recommend always placing a colon at the start of a header.

## Output Queue and Input Buffer

### ■ Output Queue

Response messages are stored in the output queue until read by the controller. The output queue is also cleared in the following circumstances:

- Power on
- Device clear 
- Query Error

The output queue capacity of the instrument is 64 bytes. If response messages overflow the buffer, a query error is generated and the output queue is cleared.

Also, with GP-IB, if a new message is received while data remains in the output queue, the output queue is cleared and a query error is generated.

### ■ Input Buffer

The input buffer capacity of the instrument is 256 bytes.

If 256 bytes are allowed to accumulate in this buffer so that it becomes full, the GP-IB interface bus enters the waiting state until space is cleared in the buffer.

The RS-232C interface will not accept data beyond 256 bytes.

#### NOTE

Ensure that the no command ever exceeds 256 bytes.

## Status Byte Register

### GP-IB

This instrument implements the status model defined by IEEE 488.2 with regard to the serial poll function using the service request line.

The term “event” refers to any occurrence that generates a service request.

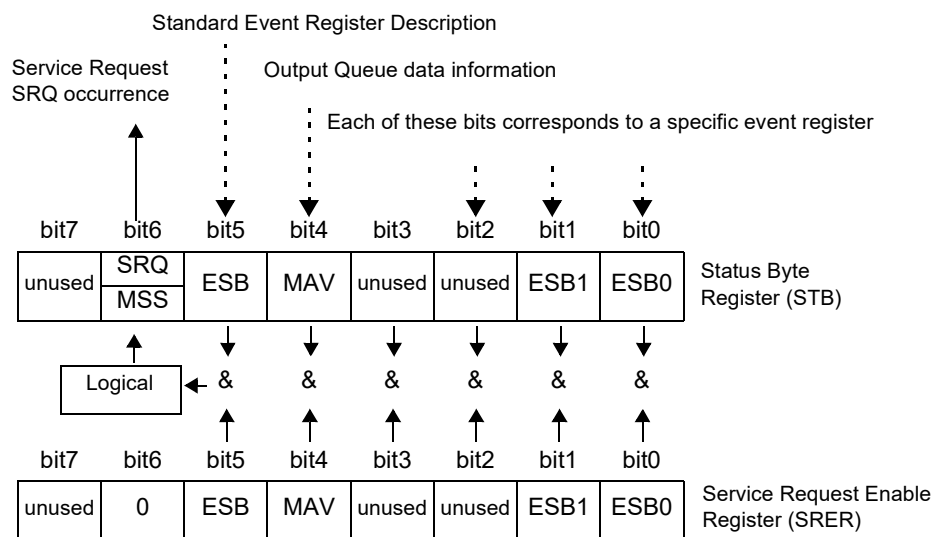

The Status Byte Register contains information about the event registers and the output queue. Required items are selected from this information by masking with the Service Request Enable Register. When any bit selected by the mask is set, bit 6 (MSS; the Master Summary Status) of the Status Byte Register is also set, which generates an SRQ (Service Request) message and dispatches a service request.

### NOTE

SRQ (Service Request) is a GP-IB function only. However, STB (Status Byte Register) information can be acquired with RS-232C using the **\*STB?** command.

### RS-232C

RS-232C does not provide a function for issuing service requests. Still, SRER setup and STB reading are available.

## ■ Status Byte Register (STB)

During serial polling, the contents of the 8-bit Status Byte Register are sent from the instrument to the controller.

When any Status Byte Register bit enabled by the Service Request Enable Register has switched from 0 to 1, the MSS bit becomes 1. Consequently, the SRQ bit is set to 1, and a service request is dispatched.

The SRQ bit is always synchronous with service requests, and is read and simultaneously cleared during serial polling. Although the MSS bit is only read by an **\*STB?** query, it is not cleared until a clear event is initiated by the **\*CLS** command.

<b>Bit 7</b>		unused
<b>Bit 6</b>	<b>SRQ</b>	Set to 1 when a service request is dispatched.
	<b>MSS</b>	This is the logical sum of the other bits of the Status Byte Register.
<b>Bit 5</b>	<b>ESB</b>	Standard Event Status (logical sum) bit This is logical sum of the Standard Event Status Register.
<b>Bit 4</b>	<b>MAV</b>	Message available Indicates that a message is present in the output queue.
<b>Bit 3</b>		unused
<b>Bit 2</b>		unused
<b>Bit 1</b>	<b>ESB1</b>	Event Status (logical sum) bit 1 This is the logical sum of Event Status Register 1.
<b>Bit 0</b>	<b>ESB0</b>	Event Status (logical sum) bit 0 This is the logical sum of Event Status Register 0.

## ■ Service Request Enable Register (SRER)

This register masks the Status Byte Register. Setting a bit of this register to 1 enables the corresponding bit of the Status Byte Register to be used.



## Event Registers

### ■ Standard Event Status Register (SESR)

The Standard Event Status Register is an 8-bit register.

If any bit in the Standard Event Status Register is set to 1 (after masking by the Standard Event Status Enable Register), bit 5 (ESB) of the Status Byte Register is set to 1.

See: "Standard Event Status Register (SESR) and Standard Event Status Enable Register (SESER)" (p. 116)

The Standard Event Status Register is cleared in the following situations:

- When a \*CLS command is executed
- When an event register query (\*ESR?) is executed
- When the instrument is powered on

Bit 7	PON	<b>Power-On Flag</b> Set to 1 when the power is turned on, or upon recovery from an outage.
Bit 6	URQ	<b>User Request</b> unused
Bit 5	CME	<b>Command error (The command to the message terminator is ignored.)</b> This bit is set to 1 when a received command contains a syntactic or semantic error: <ul style="list-style-type: none"> <li>• Program header error</li> <li>• Incorrect number of data parameters</li> <li>• Invalid parameter format</li> <li>• Received a command not supported by the instrument</li> </ul>
Bit 4	EXE	<b>Execution Error</b> This bit is set to 1 when a received command cannot be executed for some reason. <ul style="list-style-type: none"> <li>• The specified data value is outside of the set range</li> <li>• The specified setting data cannot be set</li> <li>• Execution is prevented by some other operation being performed</li> </ul>
Bit 3	(unused) DDE	<b>Not used by this instrument</b> <b>Device-Dependent Error</b> This bit is set to 1 when a command cannot be executed due to some reason other than a command error, a query error or an execution error.
Bit 2	QYE	<b>Query Error (the output queue is cleared)</b> This bit is set to 1 when a query error is detected by the output queue control. <ul style="list-style-type: none"> <li>• When an attempt has been made to read an empty output queue (GP-IB only)</li> <li>• When the data overflows the output queue</li> <li>• When data in the output queue has been lost</li> <li>• When the next command is received while there is data in the output queue</li> </ul>
Bit 1	RQC (unused)	<b>Request Control</b>
Bit 0	OPC	<b>Operation Complete</b> This bit is set to 1 in response to an *OPC command. <ul style="list-style-type: none"> <li>• It indicates the completion of operations of all messages up to the *OPC command</li> </ul>

### ■ Standard Event Status Enable Register (SESER)

Setting any bit of the Standard Event Status Enable Register to 1 enables access to the corresponding bit of the Standard Event Status Register.

**Standard Event Status Register (SESR) and Standard Event Status Enable Register (SESER)**

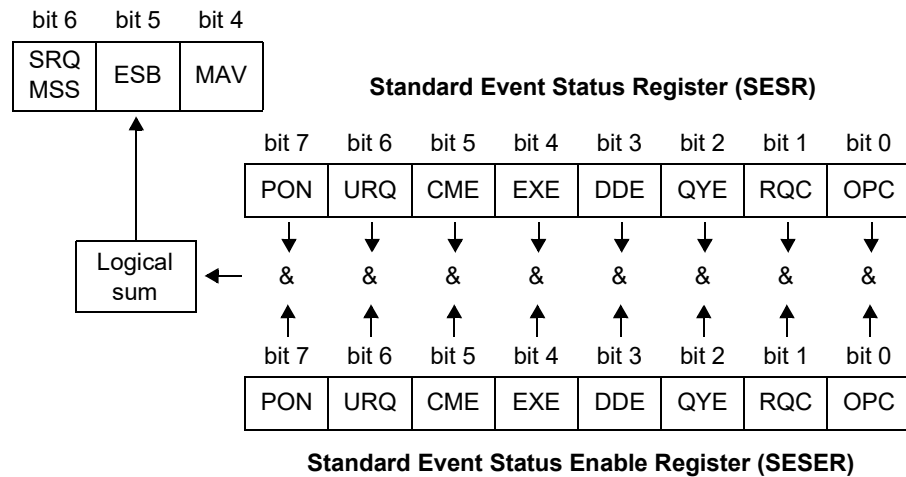

### ■ Device-Specific Event Status Registers (ESR0 and ESR1)

This instrument provides two event status registers for controlling events. Each event register is an 8-bit register.

When any bit in one of these event status registers enabled by its corresponding event status enable register is set to 1, the following happens:

- For Event Status Register 0, bit 0 (ESB0) of the Status Byte Register is set to 1.
- For Event Status Register 1, bit 1 (ESB1) of the Status Byte Register is set to 1.

Event Status Registers 0 and 1 are cleared in the following situations:

- When a **\*CLS** command is executed
- When an Event Status Register query (**:ESR0?** or **:ESR1?**) is executed
- When the instrument is powered on

**Event Status Register 0 (ESR0)**

<b>Bit 7</b>	–	Unused
<b>Bit 6</b>	OvrRng	Out-of-Range Detection Fault
<b>Bit 5</b>	ERR	Measurement Fault
<b>Bit 4</b>	Hi	High Comparator Result
<b>Bit 3</b>	IN	IN Comparator Result
<b>Bit 2</b>	Lo	Low Comparator Result
<b>Bit 1</b>	INDEX	A/D Conversion Finished
<b>Bit 0</b>	EOM	End of Measurement

**Event Status Register 1 (ESR1)**

<b>Bit 7</b>	–	Unused
<b>Bit 6</b>	–	Unused
<b>Bit 5</b>	–	Unused
<b>Bit 4</b>	–	Unused
<b>Bit 3</b>	VOLT	Voltage Level Monitor Fault
<b>Bit 2</b>	CURR	Current Monitor Fault
<b>Bit 1</b>	CE Hi	Contact Check – Hi side Fault
<b>Bit 0</b>	CE Lo	Contact Check – Lo side Fault

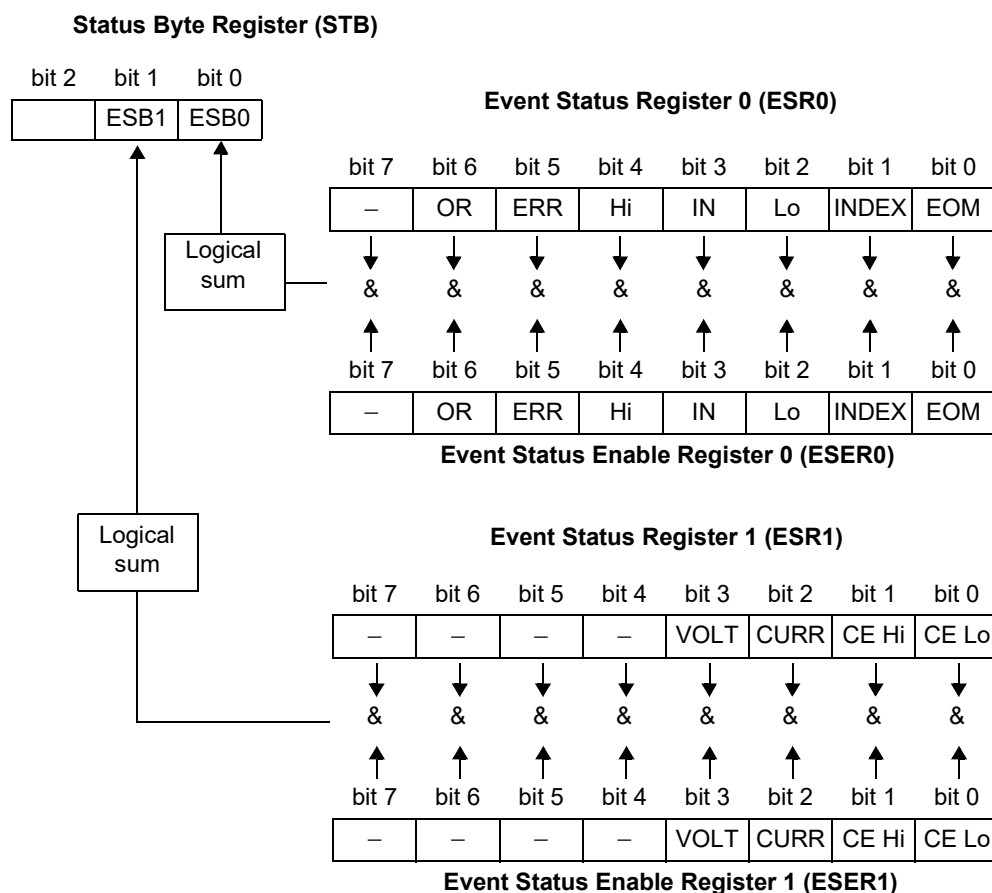
**Event Status Registers 0 (ESR0) and 1 (ESR1), and Event Status Enable Registers 0 (ESER0) and 1 (ESER1)**

## Register Reading and Writing

Register	Read	Write
Status Byte Register	*STB?	–
Service Request Enable Register	*SRE?	*SRE
Standard Event Status Register	*ESR?	–
Standard Event Status Enable Register	*ESE?	*ESE
Event Status Register 0	:ESR0?	–
Event Status Enable Register 0	:ESE0?	:ESE0
Event Status Register 1	:ESR1?	–
Event Status Enable Register 1	:ESE1?	:ESE1

## GP-IB Commands

The following commands can be used for performing interface functions.

Command	Description
GTL	Go To Local Cancels the Remote state and enters the Local state.
LLO	Local Lock Out Disables all keys, including the Local (F1) key.
DCL	Device CLear Clears the input buffer and the output queue.
SDC	Selected Device Clear Clears the input buffer and the output queue.
GET	Group Execute Trigger When an external trigger occurs, processes one sample.

## Initialization Items

Item	Initialization Method	At Power-on	Key reset	*RST Command	Device Clear (GP-IB only)	*CLS Command	Factory Default
GP-IB Address		–	1	–	–	–	1
RS-232C setting (fixed)		–	9600	–	–	–	9600
Device-specific functions (Range, etc.)		–	●	●	–	–	●
Output Queue		●	●	–	●	–	●
Input buffer		●	●	–	●	–	●
Status Byte Register		●	●	–	– *1	●*2	●
Event registers		●*3	●	–	–	●	●
Enable register		●	●	–	–	–	●
Current path		●	●	–	●	–	●
Headers on/off		OFF	OFF	OFF	–	–	OFF
Response message terminator (GP-IB)		LF+EOI	LF+EOI	–	–	–	LF+EOI
Response message separator		;	;	;	–	–	;

\*1. Only the MAV bit (bit 4) is cleared.

\*2. All bits except the MAV bit are cleared.

\*3. Except the PON bit (bit 7).

## Command Execution Time

Command execution time indicates the time for analyzing and processing long form commands.

However, the command execution time for commands with data is the time described according to the data format specified in the <data portion>, and for query commands it is the time when the header is ON.

- Display delays may occur depending on the frequency of communication processes and process contents.
- All commands except \*TRG and :INT are processed sequentially.
- In communications with the controller, time must be added for data transmission. GP-IB transfer time depends on the controller.  
The time for RS-232C transfers involving a total of 10 bits (the start bit is 1, data length is 8, no parity, stop bit is 1) is shown below.  
9600 bps: approximately 960 characters/s
- Wait until measurements stabilize after a change before using a setting command.



Command	Execution time (except communication time)
*RST	200 ms or less
:FUNction :RESistance:RANGe :SPEEd :SYSTem:CALibration :RESistance:APERture :RESistance:NPLCycles	150 ms or less
:ADJust?	2 s or less
:FETCh?	3 ms or less
:READ?	Measurement time + 3 ms or less
:SYSTem:BACKup	200 ms or less
*TST?	1s or less
Commands other than those above	10 ms or less

## Errors During Communications

An error occurs when messages are executed in the following cases:

- **Command Error**  
When message syntax (spelling) is invalid. When the data format in a command or query is invalid.
- **Query Error**  
When the response message exceeds 64 bytes
- **Execution Error**  
When invalid character or numeric data is present

## 9.6 Message List

Commands specific to RS-232C or GP-IB are identified by  or , respectively.

### Standard Commands

Message	Data Formats	Description	Ref page
* <b>CLS</b>		Clears the event registers and the Status Byte Register.	128
* <b>ESE</b>	0 to 255	Sets the contents of the Standard Event Status Enable Register.	129
* <b>ESE?</b>	[0 to 255]	Queries the Standard Event Status Enable Register.	129
* <b>ESR?</b>	[0 to 255]	Queries the Standard Event Status Register.	129
* <b>IDN?</b>	[<Manufacturer's name>,<Model name>,0,<Software version>]	Queries the Device ID.	127
* <b>OPC</b>		Requests an SRQ after execution completion.	128
* <b>OPC?</b>	1	Queries execution completion.	128
* <b>RST</b>		Initializes the device.	127
* <b>SRE</b>	0 to 255	Sets the Service Request Enable Register.	130
* <b>SRE?</b>	[0 to 255]	Queries the contents of the Service Request Enable Register.	130
* <b>STB?</b>	[0 to 255]	Queries the Status Byte Register.	130
* <b>TRG</b>		Executes one sampling.	130
* <b>TST?</b>	[0 to 7]	Initiates a self-test and queries the result.	127
* <b>WAI</b>		Wait for operations to finish.	128

#### Notes:

- < >: contents of the data portion.
- [ ]: Response data

## Device-Specific Commands

Message	Data Contents	Description	Ref page
<b>Event registers</b>			
<b>:ESE0</b>	0 to 255	Sets and queries Event Status Enable Register 0.	131
<b>:ESE0?</b>	[0 to 255]		
<b>:ESR0?</b>	[0 to 255]	Queries Event Status Register 0.	131
<b>:ESE1</b>	0 to 255	Sets and queries Event Status Enable Register 1.	131
<b>:ESE1?</b>	[0 to 255]		
<b>:ESR1?</b>	[0 to 255]	Queries Event Status Register 1.	131
<b>Resistance Measurement</b>			
<b>[ :SENSE: ] FUNCTION</b>	RESistance	Sets and queries the resistance measurement method.	132
<b>[ :SENSE: ] FUNCTION?</b>	[RESISTANCE]		
<b>Measurement Range</b>			
<b>[ :SENSE: ] RESistance: RANGE</b>	0 to 1200	Sets and queries resistance measurement range.	132
<b>[ :SENSE: ] RESistance: RANGE?</b>	[10.00000E-3 to 1000.000E+0]		
<b>Zero-adjust</b>			
<b>:ADJust?</b>	[0/ 1]	Execute zero-adjustment.	133
<b>:ADJust: CLear</b>		Cancel zero-adjustment.	133
<b>Measurement Speed</b>			
<b>:SPEEd</b>	FAST/ MEdium/ SLOW	Sets and queries measurement speed.	133
<b>:SPEEd?</b>	[FAST/ MEDIUM/ SLOW]		
<b>Statistical functions</b>			
<b>:CALCulate: STATistics: STATE</b>	1/ 0/ ON/ OFF	Sets and queries statistical calculation function execution.	134
<b>:CALCulate: STATistics: STATE?</b>	[ON/ OFF]		
<b>:CALCulate: STATistics: CLear</b>		Clears statistical calculation results.	134
<b>:CALCulate: STATistics: NUMBer?</b>	[<Total data count>,<Valid data count>]	Queries the data count.	134
<b>:CALCulate: STATistics: MEAN?</b>	[<Mean>]	Queries the mean value.	134
<b>:CALCulate: STATistics: MAXimum?</b>	[<Maximum value>,<Data no.>]	Queries the maximum value.	134
<b>:CALCulate: STATistics: MINimum?</b>	[<Minimum value>,<Data no.>]	Queries the minimum value.	134
<b>:CALCulate: STATistics: LIMit?</b>	[<Hi count>,<IN count>,<Lo count>,<Measurement fault count>,<Out-of-range count>]	Queries comparator results.	135
<b>:CALCulate: STATistics: DEVIation?</b>	[< $\sigma_n$ >,< $\sigma_{n-1}$ >]	Queries standard deviation.	135
<b>:CALCulate: STATistics: CP?</b>	[<Cp>,<CpK>]	Queries the process capability indices.	135

**Notes:**



- < >: contents of the data portion.
- [ ]: Response data

Message	Data Contents	Description	Ref page
<b>Comparator</b>			
:CALCulate:LIMit:STATe	1/ 0/ ON/ OFF	Sets and queries the comparator operating state.	135
:CALCulate:LIMit:STATe?	[ON/ OFF]		
:CALCulate:LIMit:BEEPer	OFF/ HI/ LO/ HL/ IN	Sets and queries the beep sound.	135
:CALCulate:LIMit:BEEPer?	[OFF/ HI/ LO/ HL/ IN]		
:CALCulate:LIMit:MODE	ABS/ REF	Sets and queries the decision mode.	136
:CALCulate:LIMit:MODE?	[ABS/ REF]		
:CALCulate:LIMit:ABS	<Upper threshold>, <Lower threshold>	Sets and queries ABS mode upper/lower comparator threshold values.	136
:CALCulate:LIMit:ABS?	[<Upper threshold>, <Lower threshold>]		
:CALCulate:LIMit:REFErence	<reference resistance>	Sets and queries REF% mode reference resistance.	136
:CALCulate:LIMit:REFErence?	[<reference resistance>]		
:CALCulate:LIMit:PERCent	<Upper threshold (%)>, <Lower threshold (%)>	Sets and queries REF% mode upper/lower comparator threshold percentages.	136
:CALCulate:LIMit:PERCent?	[<Upper threshold (%)>, <Lower threshold (%)>]		
:CALCulate:LIMit:RESult?	[HI/ IN/ LO/ OFF/ ERR]	Queries the comparator result.	136
<b>Self-Calibration</b>			
:SYSTem:CALibration		Execute self-calibration.	137
:SYSTem:CALibration:AUTO	1/ 0/ ON/ OFF	Sets and queries the automatic self-calibration.	137
:SYSTem:CALibration:AUTO?	[ON/ OFF]		
<b>100 mΩ range Measurement Current</b>			
:SYSTem:CURRent	0.1A/ 1A	Sets and queries the 100 mΩ range measurement current	137
:SYSTem:CURRent?	[0.1A/ 1A]		
<b>Key Beeper</b>			
:SYSTem:BEEPer:STATe	1/ 0/ ON/ OFF	Sets and queries the key beeper.	137
:SYSTem:BEEPer:STATe?	[ON/ OFF]		
<b>Line Frequency</b>			
:SYSTem:LFRequency	AUTO/ 50/ 60	Sets and queries the AC line frequency.	138
:SYSTem:LFRequency?	[AUTO/ 50/ 60]		
<b>Key-Lock</b>			
:SYSTem:KLOCK	1/ 0/ ON/ OFF	Sets and queries the key-lock.	138
:SYSTem:KLOCK?	[ON/ OFF]		
<b>Header Present</b>			
:SYSTem:HEADer	1/ 0/ ON/ OFF	Sets and queries header present.	138
:SYSTem:HEADer?	[ON/ OFF]		
<b>EOM Output</b>			
:SYSTem:EOM:MODE	HOLD/ PULSe	Sets and queries the EOM output mode.	138
:SYSTem:EOM:MODE?	[HOLD/ PULSE]		
:SYSTem:EOM:PULSe	0.001 to 0.100	Sets and queries the EOM pulse width.	138
:SYSTem:EOM:PULSe?	[0.001 to 0.100]		

**Notes:**

- < >: contents of the data portion.
- [ ]: Response data



Message	Data Contents	Description	Ref page
<b>Delimiter (Terminator)</b>			
:SYSTem:TERMinator	 0/ 1	Sets and queries the GP-IB command delimiter.	139
:SYSTem:TERMinator?	 [0/ 1]		
<b>System Function</b>			
:SYSTem:DATE	<Year>,<Month>,<Day>	Sets and queries the system date.	139
:SYSTem:DATE?	[<Year>,<Month>,<Day>]		
:SYSTem:TIME	<Hours>,<Minutes>,<Sec- onds>	Sets and queries the system time.	139
:SYSTem:TIME?	[<Hours>,<Minutes>,<Sec- onds>]		
:SYSTem:BACKUp		Backs up measurement settings.	139
:SYSTem:SETMonitor	1/ 0/ ON/ OFF	Sets and queries the Settings Monitor function.	140
:SYSTem:SETMonitor?	[ON/ OFF]		
:SYSTem:SETMonitor:ORDER	1/ 2	Sets and queries the 1st/2nd stage setting conditions (Settings Monitor function)	140
:SYSTem:SETMonitor:ORDER?	[1/ 2]		
:SYSTem:SETMonitor:ALLOWance	0 to 9.999 (%)	Sets and queries the tolerance range (Settings Monitor function).	140
:SYSTem:SETMonitor:ALLOWance?	[0 to 9.999]		
:SYSTem:LOCAL		Enables the local control state.	140
:SYSTem:DATAout	 1/ 0/ ON/ OFF	Sets and queries measurement-syn- chronized data output.	140
:SYSTem:DATAout?	 [ON/ OFF]		
:SYSTem:FORMat	ASCIi/ BINary	Sets and queries the measurement data format.	141
:SYSTem:FORMat?	[ASCIi/ BINARY]		
:SYSTem:4WCheck	1/ 0/ ON/ OFF	Sets and queries probe short-circuit detection.	141
:SYSTem:4WCheck?	[ON/ OFF]		
:SYSTem:4WCheck:TIME	0.001 to 0.1	Sets and queries probe short-circuit detection time.	141
:SYSTem:4WCheck:TIME?	[0.001 to 0.1]		
:SYSTem:RETRY	1/ 0/ ON/ OFF	Enables the measurement retry func- tion.	141
:SYSTem:RETRY?	[ON/ OFF]		
:SYSTem:RETRY:TIME	0.001 to 0.05 (seconds)	Sets and queries the retry interval.	141
:SYSTem:RETRY:TIME?	[0.001 to 0.05]		
:SYSTem:RESet		Executes a system reset.	141
<b>Trigger</b>			
:INITiate:CONTInuous	1/ 0/ ON/ OFF	Sets and queries continuous measure- ment.	143
:INITiate:CONTInuous?	[ON/ OFF]		
:INITiate[:IMMediate]		Initiates the trigger wait state.	143
:TRIGger:SOURce	IMMediate/ EXTernal	Sets and queries the trigger source.	143
:TRIGger:SOURce?	[IMMEDIATE/ EXTERNAL]		
:TRIGger:DELay1	0 to 0.100	Sets and queries Trigger Delay 1 time.	144
:TRIGger:DELay1?	[0 to 0.100]		
:TRIGger:EDGE	RISE/ FALL	Sets and queries trigger (falling (ON)/ rising (OFF)) edge logic.	144
:TRIGger:EDGE?			

**Notes:**

- < >: contents of the data portion.
- [ ]: Response data

Message	Data Contents	Description	Ref page
<b>Reading Measured Values</b>			
:FETCh?	[<measurement value>]	Reads the most recent measurement.	145
:READ?	[<measurement value>]	Waits for trigger and reads the measured value.	145
<b>Memory Function</b>			
:MEMory:MODE	OFF/ MEMory/ AUTO	Sets and queries the memory mode.	146
:MEMory:MODE?	[OFF/ MEMORY/ AUTO]		
:MEMory:CLEar		Clears memory data.	146
:MEMory:COUNt?	[0 to 30000]	Queries the number of measurements stored in memory.	146
:MEMory:DATA?	[<Measurement value>, <measurement value>, ..., <measurement value>]	Reads the measurements stored in memory.	147
:MEMory:POINt	1 to 30000	Sets and queries the number of measurement points to store.	147
:MEMory:POINt?	[1 to 30000]		
<b>Range-Specific Resistance Measurement Settings</b>			
:RESistance:DELay2	<Range>, <Delay 2 time>	Sets and queries Delay 2.	148
:RESistance:DELay2?	<Range> [0 to 0.100]		
:RESistance:NPLCycles	<Range>, <Speed>, <Integration time (NPLC)>	Sets and queries integration time (no. of power line cycles).	148
:RESistance:NPLCycles?	<Range>, <Speed> [0.01 to 6]		
:RESistance:APERture	<Range>, <Speed>, <Integration time (s)>	Sets and queries integration time (in seconds).	148
:RESistance:APERture?	<Range>, <Speed> [0.0001 to 0.1]		
:RESistance:CIMProve	<Range>, <OFF/ HOLD/ PULSE>	Sets and queries Contact Improver operating mode.	149
:RESistance:CIMProve?	<Range> [OFF/ HOLD/ PULSE]		
:RESistance:CIMProve:LEVel	<Range>, <Level>	Sets and queries Contact Improver level.	149
:RESistance:CIMProve:LEVel?	<Range> [L1/ L2/ L3/ L4]		
:RESistance:CURREnt	<Range>, <PULSE/ CONTinuous>	Sets and queries measurement current mode.	149
:RESistance:CURREnt?	<Range> [PULSE/ CONTINUOUS]		
:RESistance:CONtactcheck	<Range>, <1/ 0/ ON/ OFF>	Sets and queries contact check operation.	150
:RESistance:CONtactcheck?	<Range> [ON/ OFF]		
:RESistance:CONtactcheck:LEVel	<Range>, <Level>	Sets and queries contact check threshold.	150
:RESistance:CONtactcheck:LEVel?	<Range> [L1/ L2/ L3/ L4/ L5/ L6/ L7]		
:RESistance:VMONitor	<Range>, <1/ 0/ ON/ OFF>	Sets and queries voltage level monitor operation.	150
:RESistance:VMONitor?	<Range> [ON/ OFF]		
:RESistance:VMONitor:LEVel	<Range>, <Level>	Sets and queries voltage level monitor level.	150
:RESistance:VMONitor:LEVel?	<Range> [L1/ L2/ L3]		

**Notes:**

- < >: contents of the data portion.
- [ ]: Response data
- <Range>: RNG10MIL/ RNG100MIL/ RNG1000MIL/ RNG10/ RNG100/ RNG1000

Message	Data Contents	Description	Ref page
<b>:RESistance:AVERage</b>	<Range>,<1/ 0/ ON/ OFF>	Sets and queries the averaging function.	151
<b>:RESistance:AVERage?</b>	<Range> [ON/ OFF]		
<b>:RESistance:AVERage:NUMBer</b>	<Range>,<Averaging iterations>	Sets and queries the averaging iterations.	151
<b>:RESistance:AVERage:NUMBer?</b>	<Range> [2 to 32]		
<b>:RESistance:SCALing</b>	<Range>,<1/ 0/ ON/ OFF>	Sets and queries scaling function.	151
<b>:RESistance:SCALing?</b>	<Range> [ON/ OFF]		
<b>:RESistance:SCALing:PARAmeterA</b>	<Range>,<Compensation coefficient>	Sets and queries the scaling function's compensation coefficient.	151
<b>:RESistance:SCALing:PARAmeterA?</b>	<Range> [0.5 to 2.0]		
<b>:RESistance:SCALing:PARAmeterB</b>	<Range>,<Offset>	Sets and queries the scaling function's offset.	151
<b>:RESistance:SCALing:PARAmeterB?</b>	<Range> [-10% of range measurement range to 10% of range measurement range]		

**Notes:**

- < >: contents of the data portion.
- [ ]: Response data
- <Range>: RNG10MIL/ RNG100MIL/ RNG1000MIL/ RNG10/ RNG100/ RNG1000

# 9.7 Message Reference

Messages specific to the RS-232C or GP-IB interface are identified by their corresponding symbols ( **RS-232C** / **GP-IB** ).

## Message Reference Interpretation

**< >**: Indicates the contents (character or numeric parameters) of the data portion of a message.  
Character parameters are returned as all capital letters.

**Numeric Parameters:**

- NRf Number format may be any of NR1, NR2 and NR3
- NR1 Integer data(e.g.: +12, -23, 34)
- NR2 Fixed-point data(e.g.: +1.23, -23.45, 3.456)
- NR3 Floating-point exponential representation data (e.g.: +1.0E-2, -2.3E+4)

Shows the command description. → **Read/Write the Standard Event Status Enable Register (\$E<sub>SE</sub>R)**

---

Shows the message syntax. Explains the command data or response message. → **Syntax**

Command **\*E<sub>SE</sub>** <0 to 255 (NR1)>  
 Query **\*E<sub>SE</sub>?**  
 Response <0 to 255 (NR1)>

Describes the message. → **Description**

**Command** The SE<sub>SE</sub>R mask is set to the numerical value 0 to 255. The initial value (at power-on) is 0.

**Query** The contents of the SE<sub>SE</sub>R, as set by the \*E<sub>SE</sub> command, are returned as an NR1 value (0 to 255).

128	64	32	16	8	4	2	1
bit 7	bit 6	bit 5	bit 4	bit 3	bit 2	bit 1	bit 0
PON	URQ	CME	EXE	DDE	QYE	RQC	OPC

Shows an example of an actual command application. (Normally described with HEADER ON, (except the HEADER command itself)). → **Example**

**\*E<sub>SE</sub> 36**  
(Sets bits 5 and 2 of SE<sub>SE</sub>R)

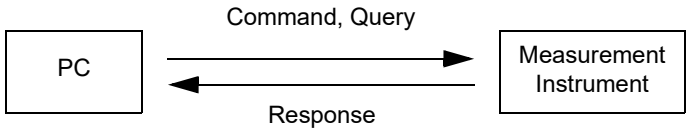

## Standard Commands

Messages specific to the RS-232C or GP-IB interface are identified by their corresponding symbols ( **RS-232C** / **GP-IB** ).

### (1) System Data Command

#### Queries device ID

**Syntax** Query **\*IDN?**  
Response **<Manufacturer's name>, <Model name>, 0, <Software version>**

**Example** **HIOKI, RM3543, 0, V1.00**  
The Device ID is HIOKI RM3543, 0, software version 1.00.  
For model RM3543-01, the <Model name> is RM3543-01.

**Note** The response message has no header.

### (2) Internal Operation Command

#### Initialize Device

**Syntax** Command **\*RST**

**Description** Command Resets the instrument to its initial state.

**Note**

- The communications state is not initialized.
- Initialized settings are not backed up.
- The following methods are available if backup is needed:  
Method 1. Use the **:SYSTEM:BACKup** command  
Method 2. Use the **:SYSTEM:RESet** command

#### Execute Self-Test and Query the Result

**Syntax** Query **\*TST?**  
Response **<0 to 7 (NR1)>**

128 bit 7	64 bit 6	32 bit 5	16 bit 4	8 bit 3	4 bit 2	2 bit 1	1 bit 0
unused	unused	unused	unused	unused	non-volatile memory	RAM	ROM

**Description** Perform instrument self-test and return the result as numerical value 0 to 7.  
Returns zero when no error occurs.

**Example** **\*TST?**  
**4**  
A non-volatile memory error occurred.  
Correct measurement may not be possible. Obtain repair before further use.

### (3) Synchronization Commands

#### Set the OPC bit of SESR When Finished All Pending Operations

---

<b>Syntax</b>	Command	<b>*OPC</b>
<b>Description</b>	Sets OPC bit 0 of the Standard Event Status Register (SESR) when all prior commands have finished processing.	

#### Respond with ASCII "1" When Finished All Pending Operations

---

<b>Syntax</b>	Query	<b>*OPC?</b>
	Response	<b>1</b>
<b>Description</b>	Responds with ASCII "1" when all prior commands have finished processing.	

#### Wait for Pending Commands to Finish



---

<b>Syntax</b>	Command	<b>*WAI</b>
<b>Description</b>	The instrument waits until all prior commands finish before executing any subsequent commands.	
<b>Note</b>	The <b>*WAI</b> command is supported because it is defined in IEEE 488.2-1987, but because all Model RM3543 device-specific commands are sequential types, this command has no actual affect.	

### (4) Status and Event Control Commands

#### Clear the Status Byte and Related Queues (Except the Output Queue)

---

<b>Syntax</b>	Command	<b>*CLS</b>
<b>Description</b>	Clears the event status registers. The Status Byte Register bits corresponding to the event status registers are also cleared. (SESR, SR0, ESR1)	
<b>Note</b>		The output queue is unaffected.
		The output queue, the various enable registers and MAV bit 4 of the Status Byte Register are unaffected.

---

## Read/Write the Standard Event Status Enable Register (SESER)

**Syntax** Command **\*ESE** <0 to 255 (NR1)>  
 Query **\*ESE?**  
 Response <0 to 255 (NR1)>

**Description** Command The SESER mask is set to the numerical value 0 to 255. The initial value (at power-on) is 0. ("Default Settings" (p. 72))  
 Query The contents of the SESER, as set by the **\*ESE** command, are returned as an NR1 value (0 to 255).

128 bit 7	64 bit 6	32 bit 5	16 bit 4	8 bit 3	4 bit 2	2 bit 1	1 bit 0
PON	URQ	CME	EXE	DDE	QYE	RQC	OPC

**Example** **\*ESE 36**  
 (Sets bits 5 and 2 of SESER)

## Read and Clear the Standard Event Status Register (SESR)

**Syntax** Query **\*ESR?**  
 Response <0 to 255 (NR1)>

**Description** Returns the contents of the SESR as an NR1 value from 0 to 255, then clears register contents. The response message has no header.

### RS-232C

128 bit 7	64 bit 6	32 bit 5	16 bit 4	8 bit 3	4 bit 2	2 bit 1	1 bit 0
PON	unused	CME	EXE	DDE	QYE	unused	unused

### GP-IB

128 bit 7	64 bit 6	32 bit 5	16 bit 4	8 bit 3	4 bit 2	2 bit 1	1 bit 0
PON	URQ	CME	EXE	DDE	QYE	RQC	OPC

**Example** **\*ESR?**  
**32**  
 Bit 5 of the SESR was set to 1.

## Write and Read the Service Request Enable Register (SRER)

**Syntax** Command `*SRE <0 to 255 (NR1)>`  
 Query `*SRE?`  
 Response `<0 to 255 (NR1)>`

**Description** Command The SRER mask is set to the numerical value 0 to 255. Although NRf numerical values are accepted, values to the right of the decimal are rounded to the nearest integer. Bit 6 and unused bits 2, 3 and 7 are ignored. The data is initialized to zero at power-on.

Query The contents of the SRER, as set by the `*SRE` command, are returned as an NR1 value (0 to 255). Bit 6 and unused bits 2, 3 and 7 always return as zero.

128 bit 7	64 bit 6	32 bit 5	16 bit 4	8 bit 3	4 bit 2	2 bit 1	1 bit 0
unused	0	ESB	MAV	unused	unused	ESE1	ESE0

**Example** `*SRE 33`  
 Set SRER bits 0 and 5 to 1.  
`*SRE?`  
 33  
 SRER bits 0 and 5 have been set to 1.

## Read the Status Byte and MSS Bit

**Syntax** Query `*STB?`  
 Response `<0 to 255 (NR1)>`

**Description** The contents of the STB are returned as an NR1 value (0 to 255). The response message has no header.

128 bit 7	64 bit 6	32 bit 5	16 bit 4	8 bit 3	4 bit 2	2 bit 1	1 bit 0
unused	MSS	ESB	MAV	unused	unused	ESE1	ESE0

**Example** `*STB?`  
 16  
 STB bit 4 has been set to 1.

## Request a Sample

**Syntax** Command `*TRG`

**Description** Performs one measurement when external triggering is enabled. When Statistical Calculation is ON, imports calculation data. When the memory function is enabled, the measured value is stored.

**Example** `:TRIGger:SOURce EXTernal;*TRG`

**Note** When an error occurs with the Settings Monitor function enabled, triggering is disabled (p. 56).



## Device-Specific Commands

### (1) Event Status Register

#### Set and Query Device-Specific Event Status Enable Register ESER0

**Syntax** Command : **ESE0** <0 to 255 (NR1)>  
 Query : **ESE0?**  
 Response <0 to 255 (NR1)>

**Description** Command Sets the mask pattern in Event Status Enable Register 0 (ESER0) for the Event Status Register.

128	64	32	16	8	4	2	1
bit 7	bit 6	bit 5	bit 4	bit 3	bit 2	bit 1	bit 0
unused	OR	ERR	Hi	IN	Lo	INDEX	EOM

**Note** Data initializes to zero at power-on.

#### Read Device-Specific Event Status Register ESR0

**Syntax** Query : **ESR0?**  
 Response <0 to 255 (NR1)>

**Note** Executing ESR0? clears the contents of ESR0.

#### Set and Query Device-Specific Event Status Enable Register ESER1

**Syntax** Command : **ESE1** <0 to 255 (NR1)>  
 Query : **ESE1?**  
 Response <0 to 255 (NR1)>

**Description** Command Sets the mask pattern in Event Status Enable Register 1 (ESER1) for the Event Status Register.

128	64	32	16	8	4	2	1
bit 7	bit 6	bit 5	bit 4	bit 3	bit 2	bit 1	bit 0
unused	unused	unused	unused	VOLT	CURR	CE Hi	CE Lo

**Note** Data initializes to zero at power-on.

#### Read Device-Specific Event Status Registers ESR1

**Syntax** Query : **ESR1?**  
 Response <0 to 255 (NR1)>

**Note** Executing ESR1? clears the contents of ESR1.



## Execute and Clear Zero-Adjustment

---

### Clear Zero-Adjustment

**Syntax**    Command    `:ADJust:CLear`

**Description**    Command    Clears any zero-adjustment offset.

### Execute Zero-Adjustment

**Syntax**    Query        `:ADJust?`

              Response    `<0/ 1>`

0 = Indicates zero-adjustment succeeded.

1 = Indicates the offset resistance exceeded 10  $\Omega$  during zero-adjustment.

## (3) Sampling

### Set and Query Measurement Speed

---

**Syntax**    Command    `:SPEEd <FAST/ MEDium/ SLOW>`

              Query        `:SPEEd?`

              Response    `<FAST/ MEDIUM/ SLOW>`

**Example**    `:SPEE MED`

`:SPEE?`

`MEDIUM`

## (4) Calculation

### Clear and Query the Statistical Calculation State

- A data sample can be taken by the following methods:
  1. Press the **F4** [MANU] key on the [MENU]-[TRG] selection screen (p. 74)
  2. Apply a TRIG signal to the external I/O connector.
  3. Send a \*TRG command.
- The `:CALCulate:STATistics:STATE` command does not clear calculation results.
- When the valid data count is 0,  $\sigma_{n-1}$  returns 0.
- When cleared, the Statistical Calculation function is not turned OFF.
- The upper limit of Cp and CpK is 99.99. If Cp or CpK exceeds 99.99, the value 99.99 is returned.
- The value 0 will be returned if the Cp and Cpk data is not valid.

### Statistical Calculation Execution State

**Syntax**    Command    `:CALCulate:STATistics:STATE <1/ 0/ ON/ OFF>`  
                   Query        `:CALCulate:STATistics:STATE?`  
                   Response    `<ON/ OFF>`

**Example**    `:CALC:STAT:STAT ON`  
                   `:CALC:STAT:STAT?`  
                   ON

### Clear Statistical Calculation Results

**Syntax**    Command    `:CALCulate:STATistics:CLEar`

### Queries the data count

**Syntax**    Query        `:CALCulate:STATistics:NUMBer?`  
                   Response    `<Total data count (NR1)>,<Valid data count (NR1)>`  
                   Data count = 0 to 30000

**Example**    `:CALC:STAT:NUMB?`  
                   23456,23449

### Query the Mean value

**Syntax**    Query        `:CALCulate:STATistics:MEAN?`  
                   Response    `<Mean (NR3)>`

### Query the Maximum value

**Syntax**    Query        `:CALCulate:STATistics:MAXimum?`  
                   Response    `<Maximum value (NR3)>,<Data No. of Maximum value (NR1)>`

**Example**    `:CALC:STAT:MAX?`  
                   12.4859E+0,1124

### Query the Minimum value

**Syntax**    Query        `:CALCulate:STATistics:MINimum?`  
                   Response    `<Minimum value (NR3)>,<Data No. of Minimum value (NR1)>`

**Query Comparator results**

**Syntax** Query **:CALCulate:STATistics:LIMit?**  
 Response <Hi count (NR1)>,<IN count (NR1)>,<Lo count (NR1)>,<Measurement fault count (NR1)>,<Out-of-range count (NR1)>

**Example** :CALC:STAT:LIM?  
 1516,9310,737,16,5

**Query Standard Deviation**

**Syntax** Query **:CALCulate:STATistics:DEVIation?**  
 Response < $\sigma_n$  (NR3)>,< $\sigma_{n-1}$  (NR3)>

**Example** :CALC:STAT:DEV?  
 0.0159E-3,0.0161E-3

**Query the Process Capability Indices**

**Syntax** Query **:CALCulate:STATistics:CP?**  
 Response <Cp (NR2)>,<CpK (NR2)>

**Example** :CALC:STAT:CP?  
 0.86,0.14

**(5) Comparator****Set and Query Comparator Settings**

When making comparator settings by commands, the measurement range is not automatically selected.

**Comparator State**

**Syntax** Command **:CALCulate:LIMit:STATE** <1/ 0/ ON/ OFF>  
 Query **:CALCulate:LIMit:STATE?**  
 Response <ON/ OFF>

**Example** :CALC:LIM:STAT ON

**Beeper State**

**Syntax** Command **:CALCulate:LIMit:BEEPer** <OFF/ HI/ LO/ HL/ IN>  
 Query **:CALCulate:LIMit:BEEPer?**  
 Response <OFF/ HI/ LO/ HL/ IN>

**Example** :CALC:LIM:BEEP HL

**Decision Mode Setting**

**Syntax** Command **:CALCulate:LIMit:MODE** <ABS/ REF>  
 Query **:CALCulate:LIMit:MODE?**  
 Response <ABS/ REF>

<ABS> = Upper threshold/Lower threshold comparison  
 <REF> = Reference percentage/tolerance comparison

**Example** :CALC:LIM:MODE REF

**Set and Query ABS Mode Upper/Lower Comparator Threshold Values**

**Syntax** Command **:CALCulate:LIMit:ABS** <Upper threshold> , <Lower threshold>  
 Query **:CALCulate:LIMit:ABS?**  
 Response <Upper threshold> , <Lower threshold>

<Upper threshold> = 0 to 1200.000E+0 (NRf)  
 <Lower threshold> = 0 to 1200.000E+0 (NRf)

**Example** :CALC:LIM:ABS 1.00035,0.99965

**Set and Query REF% Mode Reference Resistance**

**Syntax** Command **:CALCulate:LIMit:REference** <Reference Resistance>  
 Query **:CALCulate:LIMit:REference?**  
 Response <Reference Resistance>

<Reference Resistance> = 0 to 1200.000E+0 (NRf)

**Example** :CALC:LIM:REF 1.2E-3

**Set and Query REF% Mode Upper/Lower Comparator Threshold Percentages**

**Syntax** Command **:CALCulate:LIMit:PERCent** <Upper threshold (%)> , <Lower threshold (%)>  
 Query **:CALCulate:LIMit:PERCent?**  
 Response <Upper threshold (%)> , <Lower threshold (%)>

<Upper threshold (%)> = -99.990 to 99.990 (NR2)  
 <Lower threshold (%)> = -99.990 to 99.990 (NR2)

**Note** Setting resolution is 0.01% for  $\pm 10.00\%$  or more.

**Example** :CALC:LIM:PERC 1.505,-2.005

**Queries the comparator result**

**Syntax** Query **:CALCulate:LIMit:RESult?**  
 Response <HI/ IN/ LO/ OFF/ ERR>

**Example** :CALC:LIM:RES?  
 HI

## (6) System

### Self-Calibration State and Setting

---

#### Execute Self-Calibration

**Syntax** Command `:SYSTem:CALibration`

**Description** Executes self-calibration.

**Note** If this command is received while measuring, self-calibration executes after measurement is finished.

#### Set and Query Self-Calibration Execution State

**Syntax** Command `:SYSTem:CALibration:AUTO <1/ 0/ ON/ OFF>`

Query `:SYSTem:CALibration:AUTO?`

Response `<ON/ OFF>`

`<ON>` = AUTO Self-Calibration selected

`<OFF>` = MANUAL Self-Calibration selected

**Example** `:SYST:CAL:AUTO OFF`  
`:SYST:CAL:AUTO?`  
`OFF`

**Note** Even when AUTO is selected, Self-Calibration can be manually performed at any time by sending the `:SYSTem:CALibration` command.

### Set and Query the 100mΩ range Measurement Current

---

**Syntax** Command `:SYSTem:CURRent <0.1A/ 1A>`

Query `:SYSTem:CURRent?`

Response `<0.1A/ 1A>`

**Example** `:SYST:CURR 0.1A`  
`:SYST:CURR?`  
`0.1A`

**Note** The 100 mΩ range measurement condition settings are configured separately for each measurement current. Consequently, the 100 mΩ range measurement condition settings should be configured after first setting the measurement current.

### Set and Query the Key Beeper Setting

---

**Syntax** Command `:SYSTem:BEEPer:STATe <1/ 0/ ON/ OFF>`

Query `:SYSTem:BEEPer:STATe?`

Response `<ON/ OFF>`

**Example** `:SYST:BEEP:STAT ON`  
`:SYST:BEEP:STAT?`  
`ON`

### Select and Query the Line Frequency Setting

---

<b>Syntax</b>	Command	<b>:SYSTem:LFRequency</b> <AUTO/ 50/ 60>
	Query	<b>:SYSTem:LFRequency?</b>
	Response	<AUTO/ 50/ 60>
<b>Example</b>		<b>:SYST:LFR 50</b>
		<b>:SYST:LFR?</b>
		50

### Set and Query the Key-Lock State

---

<b>Syntax</b>	Command	<b>:SYSTem:KLOCK</b> <1/ 0/ ON/ OFF>
	Query	<b>:SYSTem:KLOCK?</b>
	Response	<ON/ OFF>
<b>Description</b>	Sets and queries the full key-lock state (panel key access to all settings, including comparator settings, is disabled).	
<b>Example</b>		<b>:SYST:KLOC ON</b>
		<b>:SYST:KLOC?</b>
		OFF

### Set and Query the Header Present Setting

---

<b>Syntax</b>	Command	<b>:SYSTem:HEADer</b> <1/ 0/ ON/ OFF>
	Query	<b>:SYSTem:HEADer?</b>
	Response	<ON/ OFF>
<b>Example</b>		<b>:SYST:HEAD ON</b>
		<b>:SYST:HEAD?</b>
		<b>:SYSTEM:HEADER ON</b>
<b>Note</b>	When turning the power on and after the *RST command, this is initialized to OFF (no header).	

### Select the EOM Output Setting

---

Two modes of EOM (external I/O End-of-Measurement signal) output are available (EOM is asserted at the end of measurement, and de-asserted according to the selected output mode).

See: "8.2 Timing Chart" (p. 92)

#### EOM Output Mode Setting

<b>Syntax</b>	Command	<b>:SYSTem:EOM:MODE</b> <HOLD/PULSE>
	Query	<b>:SYSTem:EOM:MODE?</b>
	Response	<HOLD/ PULSE>
		<HOLD> = Holds the $\overline{\text{EOM}}$ signal until measurement starts by the next trigger signal.
		<PULSE> = Sets EOM=OFF according to the specified pulse width.
<b>Example</b>		<b>:SYST:EOM:MODE PULS</b>

#### EOM Pulse Width Setting

<b>Syntax</b>	Command	<b>:SYSTem:EOM:PULSe</b> <Pulse width>
	Query	<b>:SYSTem:EOM:PULSe?</b>
	Response	<Pulse width>
		<Pulse width> = 0.001 to 0.100 (NR2) (seconds)
<b>Example</b>		<b>:SYST:EOM:PULS 0.005</b>

---



## Delimiter Setting

**Syntax** Command `:SYSTem:TERMinator <0/ 1>`  
 Query `:SYSTem:TERMinator?`  
 Response `<0/ 1>`  
 <0> = LF+EOI  
 <1> = CR+LF with EOI

**Example** `:SYST:TERM 1`  
`:SYST:TERM?`  
`0`

**Note**

- At power-on, this is set to 0 (LF+EOI).
- The RS-232C terminator is fixed as CR+LF.

## Set and Query the System Date

**Syntax** Command `:SYSTem:DATE <Year> , <Month> , <Day>`  
 Query `:SYSTem:DATE?`  
 Response `<Year> , <Month> , <Day>`  
 <Year> = 00 to 99  
 <Month> = 01 to 12  
 <Day> = 01 to 31

**Description** Sets and queries the date of the real-time system clock.

**Error** Attempting to set an out-of-range numerical value returns an execution error.  
 Attempting to set a non-existent date (such as 09,06,31) returns an execution error.

**Example** `:SYST:DATE 9,10,5`  
`:SYST:DATE?`  
`09,12,03`

## Set and Query the System Time

**Syntax** Command `:SYSTem:TIME <Hours> , <Minutes> , <Seconds>`  
 Query `:SYSTem:TIME?`  
 Response `<Hours> , <Minutes> , <Seconds>`  
 <Hours> = 00 to 23  
 <Minutes> = 00 to 59  
 <Seconds> = 00 to 59

**Description** Sets and queries the time of the real-time system clock.

**Example** `:SYST:TIME 08,25,00`  
`:SYST:TIME?`  
`23,09,53`

## Measurement Settings Backup

**Syntax** Command `:SYSTem:BACKup`

**Description** Stores current measurement settings in non-volatile memory. Changes to measurement settings by communications commands are not backed up (and are lost when power is turned off).  
 Use this command to store the settings as occasion demands.

## Compare and Query Measurement Settings on Two Instruments (Settings Monitor Function)

---

### Set and Query Settings Comparison

**Syntax**    Command    **:SYSTem:SETMonitor** <1/ 0/ ON/ OFF>  
                   Query        **:SYSTem:SETMonitor?**  
                   Response    <ON/ OFF>

**Description**    When using two instruments, this function checks that comparator and other settings are the same on both.  
                   **See:** "4.11 Comparing the Measurement Settings of Two Instruments (Settings Monitor Function)" (p. 56)

**Example**        **:SYST:SETM ON**

### Set and Query Settings Monitor Order (1<sup>st</sup> and 2<sup>nd</sup> Stages)

**Syntax**    Command    **:SYSTem:SETMonitor:ORDer** <1/ 2>  
                   Query        **:SYSTem:SETMonitor:ORDer?**  
                   Response    <1/ 2 (NR1)>

**Example**        **:SYST:SETM:ORD 1**

### Set and Query Settings Monitor Tolerance

**Syntax**    Command    **:SYSTem:SETMonitor:ALLowance** <0 to 9.999 (%)>  
                   Query        **:SYSTem:SETMonitor:ALLowance?**  
                   Response    <0 to 9.999 (NR1)>[%]

**Example**        **:SYST:SETM:ALL 0.5**

### Return to Local Control

---

**Syntax**    Command    **:SYSTem:LOCal**

**Description**    Disables communications remote control and re-enables local control. The panel keys are re-enabled.

**Example**        **:SYST:LOC**

### Set and Query Measurement-Synchronized Data Output

---

**Syntax**    Command    **:SYSTem:DATAout** <1/ 0/ ON/ OFF>  
                   Query        **:SYSTem:DATAout?**  
                   Response    <ON/ OFF>

**Description**    ON: The measured value is automatically sent each time an externally triggered measurement is finished. During internal triggering, measured values are sent automatically whenever the TRIG signal is applied.  
                   OFF: Measured values are not automatically sent.  
                   This command is not applicable to the GP-IB Interface.

---

## Set and Query the Measurement Data Format

**Syntax** Command `:SYSTem:FORMat <ASCIi/ BINary>`  
 Query `:SYSTem:FORMat?`  
 Response `<ASCIi/ BINARY>`

**Description** The data format for sending measurement values can be set to ASCII strings or binary data.

**Note** Binary format supports high-speed transfers, but requires binary data support at the receiving end (p. 107).  
 When set in binary data format, the delimiter is not sent from this instrument.

## Select and Query the Probe Short-Circuit Detection

### Probe Short-Circuit Detection Enable/Disable

**Syntax** Command `:SYSTem:4WCheck <1/ 0/ ON/ OFF>`  
 Query `:SYSTem:4WCheck?`  
 Response `<ON/ OFF>`

### Probe Short-Circuit Detection Timing

**Syntax** Command `:SYSTem:4WCheck:TIME <Time for Detection>`  
 Query `:SYSTem:4WCheck:TIME?`  
 Response `<Time for Detection>`  
`<Time for Detection> = 0.001 to 0.1 (seconds)`

**Description** Probe short-circuit detection is performed after the specified time for detection following end-of-measurement. At the end of measurement, remove the probes from the measurement object within the time specified for detection.

**Example** `:SYST:4WCH:TIME 0.01`

## Select and Query the Retry Function

### Measurement Retry Function Enable/Disable

**Syntax** Command `:SYSTem:RETRy <1/ 0/ ON/ OFF>`  
 Query `:SYSTem:RETRy?`  
 Response `<ON/ OFF>`

**Example** `:SYST:RETR ON`

### Set and Query the Retry Interval

**Syntax** Command `:SYSTem:RETRy:TIME <0.001 to 0.05 (seconds)>`  
 Query `:SYSTem:RETRy:TIME?`  
 Response `<0.001 to 0.05 (NR1)> (seconds)`

**Example** `:SYST:RETR:TIME 0.02`

## System Reset

**Syntax** Command `:SYSTem:RESet`

**Description** Initializes all except communications and clock settings. After initialization, settings are stored in non-volatile memory for backup.

### (7) Triggering

#### Relationship Between Trigger Source and Continuous Measurement Operation

Operation depends on the continuous measurement setting (`:INITIATE:CONTINUOUS`, (p. 143)) and the trigger source setting (`:TRIGGER:SOURCE`,(p. 143)), as follows.

See: "9.8 Data Exporting Methods" (p. 152)

Measurement Flow		Continuous Measurement Command-Specific Settings	
		<code>:INITIATE:CONTINUOUS ON</code>	<code>:INITIATE:CONTINUOUS OFF</code>
Trigger Source	<code>:TRIGGER:SOURCE IMM</code>	<p>Free-Run state. Measurement continues automatically.</p>	<p>Trigger by <code>:INITIATE</code> (or <code>:READ?</code>) command.</p>
	<code>:TRIGGER:SOURCE EXT</code>	<p>Trigger by <math>\overline{\text{TRIG}}</math> signal, F4 [MANU] key or <code>*TRG</code> command. After measurement, enters the trigger wait state.</p>	<p>Issue <code>:INITIATE</code> (or <code>:READ?</code>) command to wait for trigger. Trigger by <math>\overline{\text{TRIG}}</math> signal.</p>

#### `:INITIATE:CONTINUOUS OFF`

Can only be set by Remote command.

If this has been set to OFF when operation is returned to the Local state or power is turned off, the following state occurs when power is turned back on.

`:INITIATE:CONTINUOUS ON` ("To cancel the Remote state (enter the local state)" (p. 108)

Exporting measured values: "9.8 Data Exporting Methods" (p. 152)

## Continuous Measurement Setting

**Syntax** Command `:INITiate:CONTinuous <1/ 0/ ON/ OFF>`  
 Query `:INITiate:CONTinuous?`  
 Response `<ON/ OFF>`

`<ON>` = Continuous Measurement Enabled  
`<OFF>` = Continuous Measurement Disabled

**Description**

- Continuous Measurement Enabled:  
After measurement, enters the Trigger Wait State. When the trigger source setting is IMMEDIATE, the next trigger occurs immediately (the Free-Run State).
- Continuous Measurement Disabled:  
After measurement, enters the Idle State instead of the Trigger Wait State.
- Triggering is ignored in the Idle State. Executing `:INITiate[:IMMEDIATE]` enables the Trigger Wait State.
- Continuous measurement is enabled upon exit from the Remote State.

**Example**  
`:INIT:CONT OFF`  
`:INIT:CONT?`  
 ON

## Trigger Wait Setting

**Syntax** Command `:INITiate[:IMMEDIATE]`

**Description** Switches triggering from the Idle State to the Trigger Wait State.

**Example** Disable continuous measurement, and read one value for each trigger event.

Sending

`:TRIG:SOUR IMM`..Trigger immediately when entering Trigger Wait State

`:INIT:CONT OFF`..Disables continuous measurement

`:INIT`.....Enable Trigger Wait Trigger immediately upon `:TRIG:SOUR IMM`

`:FETC?`.....Fetch measured value

Reading

`2.16414E-3`.....Measured value is 2.16414 mΩ

**Error** An execution error occurs when continuous measurement is enabled.

(`:INITiate:CONTINUOUS ON`).

**Note**

- When the trigger source is IMMEDIATE, triggering occurs immediately before entering the Idle State.
- When the trigger source is EXTERNAL, the Trigger Wait State is enabled to wait for an external trigger, and when a trigger occurs, one measurement is taken before entering the Idle State.

## Trigger Source Setting

**Syntax** Command `:TRIGger:SOURce <IMMEDIATE/ EXTERNAL>`  
 Query `:TRIGger:SOURce?`  
 Response `<IMMEDIATE/ EXTERNAL>`

`<IMMEDIATE>` = Internal triggering

`<EXTERNAL>` = External triggering

**Description** Trigger by pressing F4 [MANU] on the [MENU]-[TRG] selection screen,  $\overline{\text{TRIG}}$  signal or `*TRG` command.

**Example**  
`:TRIG:SOUR IMM`  
`:TRIG:SOUR?`  
 IMMEDIATE

**Note** When external (EXT) triggering is enabled, the auto-memory mode is disabled (OFF).

### Set and query the Trigger Delay 1 time

---

**Syntax** Command :TRIGger:DElay1 <Delay1 time>  
 Query :TRIGger:DElay1?  
 Response <Delay1>  
 <Delay1 time> = 0 to 0.100 (NR2) (seconds)

**Example** :TRIG:DEL1?  
 0.010

### Set and Query the Trigger Signal Logic

---

**Syntax** Command :TRIGger:EDGE <RISE/ FALL>  
 Query :TRIGger:EDGE?  
 Response <RISE/ FALL>  
 <RISE> = Rising (OFF) edge  
 <FALL> = Falling (ON) edge

**Description** Set the operating logic of the  $\overline{\text{TRIG}}$  signal at external I/O pins.

**Example** :TRIG:EDGE?  
 FALL

## (8) Reading Measured Values

### Measurement Value Formats

Measurement Range	Measured Value	$\pm$ OvrRng	Measurement Fault
10m $\Omega$	$\pm$ □□.□□□□□E-3	$\pm$ 10.00000E+8	+10.00000E+9
100m $\Omega$	$\pm$ □□□.□□□□□E-3	$\pm$ 100.0000E+7	+100.0000E+8
1000m $\Omega$	$\pm$ □□□□.□□□□E-3	$\pm$ 1000.000E+6	+1000.000E+7
10 $\Omega$	$\pm$ □□.□□□□□E+0	$\pm$ 10.00000E+8	+10.00000E+9
100 $\Omega$	$\pm$ □□□.□□□□□E+0	$\pm$ 100.0000E+7	+100.0000E+8
1000 $\Omega$	$\pm$ □□□□.□□□□E+0	$\pm$ 1000.000E+6	+1000.000E+7

**Note** For positive measured values, a space (ASCII 20H) represents the sign.

---

Time to receive measured values is different for the **:FETCh?** and **:READ?** commands.

[See](#): "9.8 Data Exporting Methods" (p. 152)

## Reading the Most Recent Measurement

**Syntax** Query **:FETCh?**

**Description** Reads the most recent measurement. No trigger occurs.

[See](#): "Measurement Value Formats" (p. 144)

**Example** **:FETC?**

1023.579E-3

**Note** Binary data is returned when the Binary sending format is selected.

## Measuring (Awaiting Triggers and Reading Measurements)

**Syntax** Query **:READ?**

**Description** Switches from the Idle State to the Trigger Wait State, then reads the next measured value. With auto-ranging enabled, the most suitable range is selected before measurement.

Trigger Source	Operation
IMMediate	Triggers and reads measured value.
EXTernal	Triggers by $\overline{\text{TRIG}}$ signal (EXT I/O) input, and continuously reads measured values.

[See](#): "Measurement Value Formats" (p. 144)

**Error** • This command causes an execution error if issued during the Continuous Measurement state (after :INITIATE:CONTINUOUS ON).

• This command causes an execution error if issued during the Trigger Wait State.

**Note** • The next command does not execute until measurement is finished.

• When using an external trigger source (EXT) with auto-sending of measured values (Auto-Memory function) enabled, returned measured values will be duplicated. Therefore, disable the Auto-Memory function when triggering externally.

[See](#): "6.4 Auto-Exporting Measured Values (at End of Measurement) (Data Output Function)" (p. 81)

• Binary data is returned when the Binary sending format is selected.

## (9) Memory Functions

You can save and load up to 30000 measurement data entries.

### Set and Query Memory Functions

---

#### Memory Function Execution Mode

**Syntax** Command **:MEMory:MODE** <OFF/ MEMory/ AUTO>

Query **:MEMory:MODE?**

Response <OFF/ MEMORY/ AUTO>

<OFF> = Memory function OFF

<MEMORY> = Memory function

<AUTO> = Auto memory function

**Description** Selects the memory function operation mode.

The Memory function can be disabled (OFF), set to store one data item (MEM), or set for auto-memory (AUTO) operation.

**Example** **:MEM:MODE MEM**

**:MEM:MODE?**

**AUTO**

- Note**
- Changing the memory mode setting erases stored data.
  - Enabling the auto-memory mode automatically selects internal [INT] triggering and enables statistical calculation.

#### Clear Memory Data

**Syntax** Command **:MEMory:CLEar**

**Example** **:MEM:CLE**

#### Retrieve the Memory Data Count

**Syntax** Query **:MEMory:COUNT?**

Response <Memory data count >

<Memory data count > = 0 to 30000 (NR1)

**Example** **:MEM:COUN?**

**3**

---



## Read Memory Data

**Syntax** Query `:MEMory:DATA?`  
 Response `<Measurement value (NR3)>,<Measurement value (NR3)>,...,<Measurement value (NR3)>`

**Description** Measured values transferred from memory are separated by commas (","),. The number of stored measurement values to be exported can be acquired by the `:MEMory:COUNT?` query. Data stored by both the data (MEM) and auto-memory (AUTO) modes can be acquired by this command (although only one mode can be enabled at a time).

**See:** "Measurement Value Formats" (p. 144)

- Note**
- Memory data is available only by remote command.
  - Memorize measurement values with the  $\overline{\text{TRIG}}$  signal, **F4** [MANU] key on the [MENU]-[TRG] selection screen, or \*TRG command.
  - Binary data is returned when the Binary sending format is selected.

## Set and Query the Memory Point (maximum data quantity)

**Syntax** Command `:MEMory:POINT <1 to 30000>`  
 Query `:MEMory:POINT?`  
 Response `<1 to 30000>`

**Description** Sets the number of measured values that can be stored. When the number of stored values reach the memory point number, no further values are stored (no overwriting occurs).

**Example**  
`:MEM:POIN 1000`  
`:MEM:POIN?`  
`1000`

- Note**
- When the auto-memory mode is enabled, the maximum memory point number is 99. Although the value may be set higher with the `:MEMory:POINT` command, the memory is limited to 100 measurement values.
  - When the auto-memory mode is enabled, stored data is erased when the memory point number is changed.

**(10) Measurement Settings****Set and Query Delay 2 (after applying measurement current)**

---

**Syntax** Command **:RESistance:DElay2** <Range> , <Delay 2 time>  
 Query **:RESistance:DElay2?** <Range>  
 Response <Delay 2 time>

<Range> = RNG10MIL/ RNG100MIL/ RNG1000MIL/ RNG10/ RNG100/ RNG1000  
 <Delay 2 time> = 0 to 0.1 (seconds)

**Example** :RES:DEL2 RNG1000MIL,0.003  
 :RES:DEL2? RNG10  
 0.005

**Set and Query Integration Time (no. of power line cycles)**

---

**Syntax** Command **:RESistance:NPLCycles** <Range> , <Speed> , <Integration time (NPLC)>  
 Query **:RESistance:NPLCycles?** <Range> , <Speed>  
 Response <Integration time (NPLC)>

<Range> = RNG10MIL/ RNG100MIL/ RNG1000MIL/ RNG10/ RNG100/ RNG1000  
 <Speed> = SLOW/ MEDium/ FAST  
 <Integration time (NPLC)> = 0.01 to 6

**Description** Sets the integration time as an integer multiple of power line cycles (NPLC).

- Note**
- For high-resistance measurements, hum noise is suppressed and stable measured values are acquired by setting an integer multiple of power line cycles.
  - When converting to seconds, values over 100 ms are set to 100 ms.
  - When querying the integration time, the instrument's internal variable is converted and output. So in some cases, the returned value may not match the set value.

**Set and Query Integration Time (in seconds)**

---

**Syntax** Command **:RESistance:APERture** <Range> , <Speed> , <Integration time (seconds)>  
 Query **:RESistance:APERture?** <Range> , <Speed>  
 Response <Integration time (seconds)>

<Range> = RNG10MIL/ RNG100MIL/ RNG1000MIL/ RNG10/ RNG100/ RNG1000  
 <Speed> = SLOW/ MEDium/ FAST  
 <Integration time> = 0.0001 to 0.1 (seconds)

**Description** Sets the integration time, in seconds.

---

### Set and Query Contact Improver Operating Mode

---

**Syntax** Command **:RESistance:CIMProve** <Range>, <OFF/ HOLD/ PULSe>  
 Query **:RESistance:CIMProve?** <Range>  
 Response <OFF/ HOLD/ PULSE>

<Range> = RNG10MIL/ RNG100MIL/ RNG1000MIL/ RNG10/ RNG100/ RNG1000

**Description** Sets Contact Improver operation to OFF, HOLD or PULSE.

### Set and Query Contact Improver Level

---

**Syntax** Command **:RESistance:CIMProve:LEVel** <Range>, <Level>  
 Query **:RESistance:CIMProve:LEVel?** <Range>  
 Response <Level>

<Range> = RNG10MIL/ RNG100MIL/ RNG1000MIL/ RNG10/ RNG100/ RNG1000

<Level> = L1/ L2/ L3/ L4 (applied current)  
 (L1: 17 mA/ L2: 25 mA/ L3: 35 mA/ L4: 50 mA)

**Description** Sets the level of current applied by the Contact Improver function.

### Set and Query Measurement Current Mode

---

**Syntax** Command **:RESistance:CURRent** <Range>, <PULSe/ CONTInuous>  
 Query **:RESistance:CURRent?** <Range>  
 Response <Range>, <PULSE/ CONTINUOUS>

<Range> = RNG10MIL/ RNG100MIL/ RNG1000MIL/ RNG10/ RNG100/ RNG1000

<PULSe> = Measurement current is applied as a pulse only during measurement.

<CONTInuous> = Measurement current is applied continuously.

**Description** Selects the method of current application. Select CONTInuous when measuring objects that require time for stabilization after applying measurement current.

**Note** When using the Contact Improver function (set to HOLD or PULSE), measurement current is only applied as a pulse, even if CONTInuous is selected here. Therefore, to measure with continuous current, the Contact Improver function must be disabled (set to OFF). (p. 149)

### Set and Query Contact Check Operation

---

**Syntax** Command :RESistance:CONtactcheck <Range>,<1/ 0/ ON/ OFF>  
 Query :RESistance:CONtactcheck? <Range>  
 Response <ON/ OFF>

<Range> = RNG10MIL/ RNG100MIL/ RNG1000MIL/ RNG10/ RNG100/ RNG1000

**Description** Enables/disables the Contact Check function.

### Set and Query Contact Check Threshold

---

**Syntax** Command :RESistance:CONtactcheck:LEVel <Range>,<Level>  
 Query :RESistance:CONtactcheck:LEVel? <Range>  
 Response <Level>

<Range> = RNG10MIL/ RNG100MIL/ RNG1000MIL/ RNG10/ RNG100/ RNG1000  
 <Level> = L1/ L2/ L3 / L4/ L5/ L6/ L7  
 Contact Check Error Threshold:  
 (L1: 50Ω/ L2: 100Ω/ L3: 150Ω/ L4: 200Ω/ L5: 300Ω/ L6: 400Ω/  
 L7: 500Ω)

**Description** Sets the error threshold value for contact checking.

### Set and Query Voltage Level Monitor Level

---

**Syntax** Command :RESistance:VMONitor <Range>,<1/ 0/ ON/ OFF>  
 Query :RESistance:VMONitor? <Range>  
 Response <ON/ OFF>

<Range> = RNG10MIL/ RNG100MIL/ RNG1000MIL/ RNG10/ RNG100/ RNG1000

**Description** Enables/disables the voltage level monitor function.

### Set and Query Voltage Level Monitor Level

---

**Syntax** Command :RESistance:VMONitor:LEVel <Range>,<Level>  
 Query :RESistance:VMONitor:LEVel? <Range>  
 Response <Level>

<Range> = RNG10MIL/ RNG100MIL/ RNG1000MIL/ RNG10/ RNG100/ RNG1000  
 <Level> = L1/ L2/ L3  
 (L1: Loose/ L2: Normal/ L3: Severe)

**Description** Sets the error level for the voltage level monitor function.

---

## Set and Query Averaging Function

**Syntax** Command **:RESistance:AVERage** <Range> , <1/ 0/ ON/ OFF>  
 Query **:RESistance:AVERage?** <Range>  
 Response <ON/ OFF>

<Range> = RNG10MIL/ RNG100MIL/ RNG1000MIL/ RNG10/ RNG100/ RNG1000

**Description** Enables/disables the averaging function.

## Set and Query Averaging Iterations

**Syntax** Command **:RESistance:AVERage:NUMBER** <Range> , <Averaging iterations (Times)>  
 Query **:RESistance:AVERage:NUMBER?** <Range>  
 Response <Averaging iterations (Times)>

<Range> = RNG10MIL/ RNG100MIL/ RNG1000MIL/ RNG10/ RNG100/ RNG1000  
 <Averaging iterations (Times)> = 2 to 32

**Description** Sets the averaging iterations.

## Set and Query Scaling Function

**Syntax** Command **:RESistance:SCALing** <Range> , <1/ 0/ ON/ OFF>  
 Query **:RESistance:SCALing?** <Range>  
 Response <ON/ OFF>

<Range> = RNG10MIL/ RNG100MIL/ RNG1000MIL/ RNG10/ RNG100/ RNG1000

**Description** Enables/disables the scaling function.

## Set and Query Scaling Function's Compensation Coefficient

**Syntax** Command **:RESistance:SCALing:PARAmeterA** <Range> , <Compensation coefficient>  
 Query **:RESistance:SCALing:PARAmeterA?** <Range>  
 Response <Compensation coefficient>

<Range> = RNG10MIL/ RNG100MIL/ RNG1000MIL/ RNG10/ RNG100/ RNG1000  
 <Compensation coefficient> = 0.5 to 2.0

**Description** Sets the scaling function's compensation coefficient.

## Set and Query Scaling Function's Offset

**Syntax** Command **:RESistance:SCALing:PARAmeterB** <Range> , <Offset>  
 Query **:RESistance:SCALing:PARAmeterB?** <Range>  
 Response <Offset>

<Range> = RNG10MIL/ RNG100MIL/ RNG1000MIL/ RNG10/ RNG100/ RNG1000  
 <Offset> = -10% of range measurement range to 10% of range measurement range

**Description** Sets the scaling function's offset.

## 9.8 Data Exporting Methods

### Basic Data Exporting Methods

Flexible data exporting is available depending on the application.

#### Free-Run Data Exporting

---

Initial Setup	: <b>INITiate:CONTinuous ON</b> (continuous measurement enable) : <b>TRIGger:SOURce IMMEDIATE</b> (internal triggering)
Exporting	: <b>FETCh?</b> Imports the most recent measurement.

#### Exporting by Host Triggering

---

Initial Setup	: <b>INITiate:CONTinuous OFF</b> (continuous measurement disable) : <b>TRIGger:SOURce IMMEDIATE</b> (internal triggering)
Exporting	: <b>READ?</b> A trigger occurs, and a measurement is taken and the result is transferred.

#### Exporting by Pressing the F4 [MANU] Key<sup>\*1</sup> or Applying $\overline{\text{TRIG}}$ Signal

---

Initial Setup	: <b>INITiate:CONTinuous OFF</b> (disable continuous measurement) : <b>TRIGger:SOURce EXT</b> (external triggering)
Exporting	: <b>READ?</b> When triggered by the <b>F4</b> [MANU] Key <sup>*1</sup> or $\overline{\text{TRIG}}$ signal, a measurement is taken and the result is transferred.

\*1. The **F4** [MANU] key indicator is displayed when [TRG: EXT] is selected on the Basic Setting screen.

### Using the :FETCh? Command during Continuous Measurement with Internal Triggering

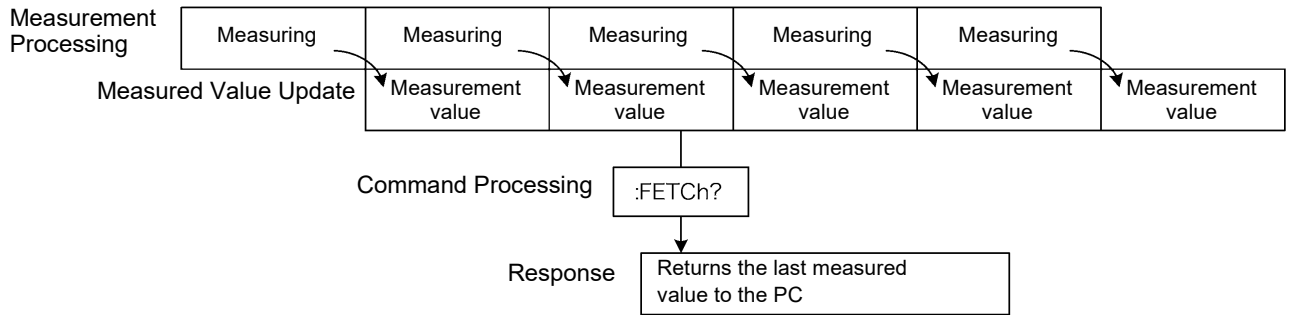

This is the simplest method for exporting measured values. It is ideal when measurement (tact) time is not limited, and when external synchronization is not needed. After connecting to the measurement object, wait for twice the measurement time plus the self-calibration time (about 130 ms) before exporting the measured value.

### Using the :READ? Command while Continuous Measurement is Disabled

#### Internal Trigger Case

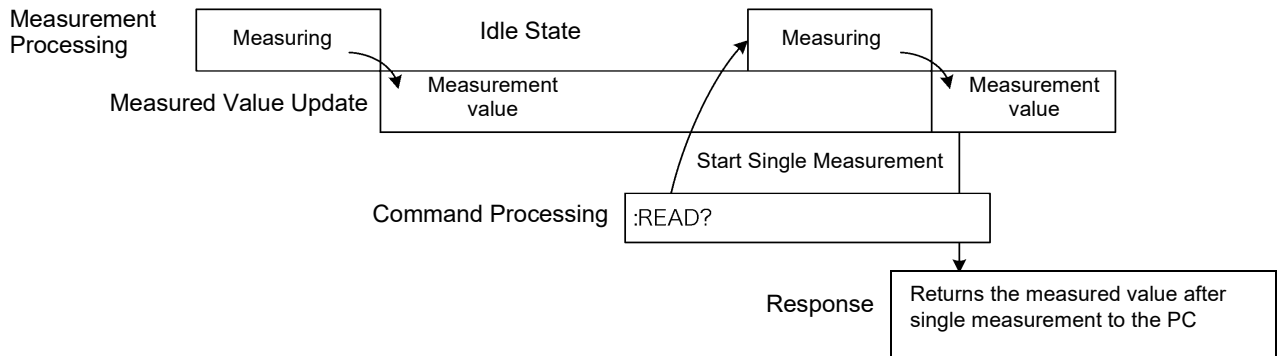

#### External Trigger Case

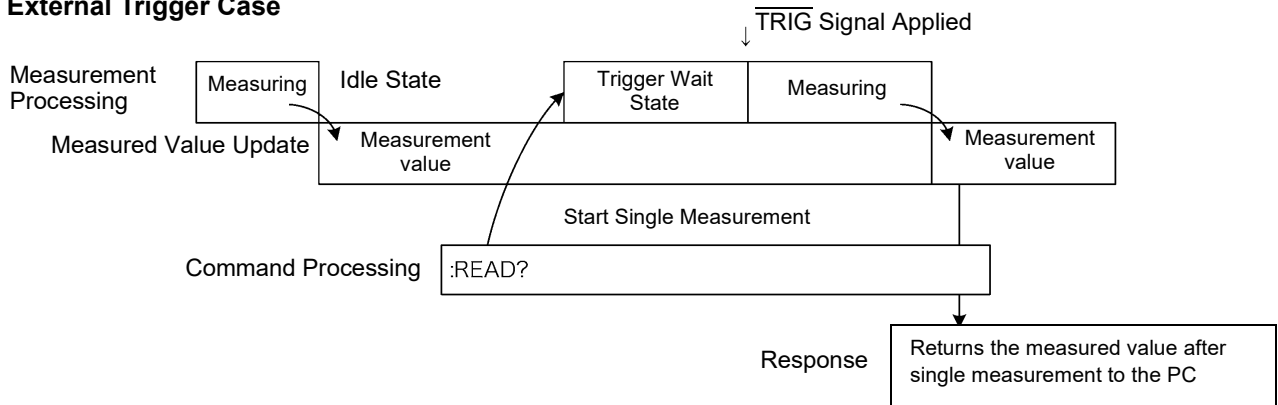

Use this method to measure (and export) synchronously with the PC or external trigger signal. Measurement time can be minimized.

## 9.9 Sample Programs

These programs can be created using Visual Basic® 5.0, 6.0 or Visual Basic® 2005 (p. 164). Visual Basic® is a registered trademark of Microsoft Corporation.

### Using Visual Basic® 5.0 or 6.0

These sample programs are created with Microsoft® Visual Basic® 5.0 and 6.0.

The following are used for communication:

For RS-232C communication: MSComm from Visual Basic® Professional

For GP-IB communication: National Instruments GP-IB Board, Driver and Module for Visual Basic®

During communications, the terminator setting is supposed to be as follows:

RS-232C: CR+LF

GP-IB: LF

### RS-232C Communications

(Using Microsoft Visual Basic Professional MSComm)

#### ■ Simple Resistance Measurement

Imports measured values 10 times, and saves measurements in a text file.

```

Private Sub MeasureSubRS()
Dim recvstr As String           'Receiving char string
Dim i As Integer

MSComm1.Settings = "9600,n,8,1" 'Comm port setting
MSComm1.PortOpen = True       'Open a port
Open App.Path & "\data.csv" For Output As #1 'Open a text file for saving

MSComm1.Output = ":TRIG:SOUR IMM" & vbCrLf 'Select internal triggering
MSComm1.Output = ":INIT:CONT ON" & vbCrLf 'Continuous measurement ON
For i = 1 To 10
  MSComm1.Output = ":FETCH?" & vbCrLf 'Send ":FETCH?" to import the most recent measurement
  recvstr = "" 'From here on, continue receiving until an LF code occurs
  While Right(recvstr, 1) <> Chr(10)
    recvstr = recvstr + MSComm1.Input
    DoEvents
  Wend
  recvstr = Left(recvstr, Len(recvstr) - 2) 'Delete the terminator (CR+LF)
  Print #1, Str(i) & ", " & recvstr 'Write to the file
Next

Close #1
MSComm1.PortOpen = False
End Sub

```



## ■ Measure Resistance by PC Key

Measures and imports by key input on the PC, and saves measurements in a text file.

```

Private Sub MeasureReadSubRS()
Dim recvstr As String                                'Receiving char string
Dim i As Integer

MSComm1.Settings = "9600,n,8,1"                    'Comm port setting
MSComm1.PortOpen = True                            'Open a port
Open App.Path & "\data.csv" For Output As #1       'Open a text file for saving

MSComm1.Output = ":TRIG:SOUR IMM" & vbCrLf         'Select internal triggering
MSComm1.Output = ":INIT:CONT OFF" & vbCrLf         'Continuous measurement OFF
For i = 1 To 10
  'Wait for PC key input
  'Create a key input check routine to set InputKey() = True when a key is pressed
  Do While 1
    If InputKey() = True Then Exit Do
    DoEvents
  Loop

  'After confirming key input, measure once, and read the measured value
  MSComm1.Output = ":READ?" & vbCrLf               'Send ":READ?" to measure and import the mea-
                                                    'surement
  recvstr = ""                                       'From here on, continue receiving until an LF code
                                                    'occurs

  While Right(recvstr, 1) <> Chr(10)
    recvstr = recvstr + MSComm1.Input
    DoEvents
  Wend
  recvstr = Left(recvstr, Len(recvstr) - 2)         'Delete the terminator (CR+LF)
  Print #1, Str(i) & ", " & recvstr                 'Write to the file
Next

Close #1
MSComm1.PortOpen = False
End Sub

```

### ■ External Trigger Measurement 1

Measure and import according to external triggering of the RM3543 (F4 [MANU] key or  $\overline{\text{TRIG}}$  signal input), and save measurements in a text file.

```

Private Sub MeasureTrigSubRS()
Dim recvstr As String           'Receiving char string
Dim i As Integer

MSComm1.Settings = "9600,n,8,1" 'Comm port setting
MSComm1.PortOpen = True       'Open a port
Open App.Path & "\data.csv" For Output As #1 'Open a text file for saving

MSComm1.Output = ":TRIG:SOUR EXT" & vbCrLf 'Select external triggering
MSComm1.Output = ":INIT:CONT OFF" & vbCrLf 'Continuous measurement OFF
For i = 1 To 10
  MSComm1.Output = ":READ?" & vbCrLf      'Send ":READ?" to measure and import the measurement

  recvstr = ""                            'From here on, continue receiving until an LF code occurs
  While Right(recvstr, 1) <> Chr(10)
    recvstr = recvstr + MSComm1.Input
    DoEvents

    'Input a trigger signal to the TRIG input pin of the EXT I/O
    'connector.

  Wend
  recvstr = Left(recvstr, Len(recvstr) - 2) 'Delete the terminator (CR+LF)
  Print #1, Str(i) & "," & recvstr         'Write to the file
Next

Close #1
MSComm1.PortOpen = False
End Sub

```

## ■ External Trigger Measurement 2

Measure and import according to external triggering of the RM3543 (F4 [MANU] key or  $\overline{\text{TRIG}}$  signal input), and save measurements in a text file.

(The RM3543 imports the most recent measurement by trigger input timing with the continuous measurement state)

```

Private Sub MeasureTrig2SubRS()
Dim recvstr As String           'Receiving char string
Dim i As Integer

MSComm1.Settings = "9600,n,8,1" 'Comm port setting
MSComm1.PortOpen = True        'Open a port
Open App.Path & "\data.csv" For Output As #1 'Open a text file for saving

MSComm1.Output = ":TRIG:SOUR IMM" & vbCrLf 'Select internal triggering
MSComm1.Output = ":INIT:CONT ON" & vbCrLf 'Continuous measurement ON

'Clear confirmation of External I/O TRIG input
MSComm1.Output = ":IO:IN?" & vbCrLf
recvstr = ""
While Right(recvstr, 1) <> Chr(10)
    recvstr = recvstr + MSComm1.Input
    DoEvents
Wend

For i = 1 To 10
    'Wait for External I/O TRIG input
    Do While 1
        MSComm1.Output = ":IO:IN?" & vbCrLf
        recvstr = ""
        While Right(recvstr, 1) <> Chr(10)
            recvstr = recvstr + MSComm1.Input
            DoEvents
        Wend
        If Left(recvstr, 1) = "1" Then Exit Do
        DoEvents
    Loop

    MSComm1.Output = ":FETCH?" & vbCrLf 'Send ":FETCH?" to import the most recent measurement

    recvstr = "" 'From here on, continue receiving until an LF code occurs

    While Right(recvstr, 1) <> Chr(10)
        recvstr = recvstr + MSComm1.Input
        DoEvents
    Wend
    recvstr = Left(recvstr, Len(recvstr) - 2) 'Delete the terminator (CR+LF)
    Print #1, Str(i) & ", " & recvstr 'Write to the file
Next

Close #1
MSComm1.PortOpen = False
End Sub

```

## ■ Set Measurement State

Sets up the measurement setting state.

```
'Measurement Setting Configuration
'Configures instrument settings for measurement
'Function: Resistance Measurement
'Range: 1Ω
'Sampling: FAST
'Trigger: External trigger
'Comparator enabled, REF% mode, reference value 1 Ω, tolerance +1.0% / -1.5%, beep upon Hi or Lo
Private Sub SettingsSubRS()
MSComm1.Settings = "9600,n,8,1"           'Comm port setting
MSComm1.PortOpen = True                 'Open a port

MSComm1.Output = ":FUNC RES" & vbCrLf   'Select Resistance function
MSComm1.Output = ":RES:RANG 1E+0" & vbCrLf 'Select 1000 mΩ range
MSComm1.Output = ":SPEE FAST" & vbCrLf  'Select FAST sampling
MSComm1.Output = ":TRIG:SOUR EXT" & vbCrLf 'Select external triggering
MSComm1.Output = ":INIT:CONT ON" & vbCrLf 'Continuous measurement ON
MSComm1.Output = ":CALC:LIM:MODE REF" & vbCrLf 'From here on, comparator settings
MSComm1.Output = ":CALC:LIM:BEEP HL" & vbCrLf
MSComm1.Output = ":CALC:LIM:REF 1E+0" & vbCrLf
MSComm1.Output = ":CALC:LIM:PERC 1.0, -1.5" & vbCrLf
MSComm1.Output = ":CALC:LIM:STAT ON" & vbCrLf 'Comparator ON

MSComm1.PortOpen = False
End Sub
```

## GP-IB Communications

(Using National Instruments GP-IB Board)

### ■ Simple Resistance Measurement

Imports measured values 10 times, and saves measurements in a text file.

```

Private Sub MeasureSub()
Dim buffer As String * 20
Dim recvstr As String
Dim pad As Integer
Dim gpibad As Integer
Dim timeout As Integer
Dim ud As Integer
Dim i As Integer

pad = 0
gpibad = 1
timeout = T10s

Call ibfind("gpib0", 0)
Call ibdev(pad, gpibad, 0, timeout, 1, 0, ud)
Call SendIFC(pad)
Open App.Path & "data.csv" For Output As #1

Call Send(pad, gpibad, ":TRIG:SOUR IMM", NLEnd)
Call Send(pad, gpibad, ":INIT:CONT ON", NLEnd)
For i = 1 To 10
    Call Send(pad, gpibad, ":FETCH?", NLEnd)

    Call Receive(pad, gpibad, buffer, STOPend)
    recvstr = Left(buffer, InStr(1, buffer, Chr(10)) - 1)
    Print #1, Str(i) & ", " & recvstr
Next

Close #1
Call ibonl(pad, 0)
End Sub

```

'Receiving buffer  
'Receiving char string  
'Controller Address  
'Device Address  
'Timeout period  
'State (unused)

'Board Address 0  
'RM3543 Address 1  
'Timeout about 10s

'Initialize GP-IB

'Open a text file for saving

'Select internal triggering  
'Continuous measurement ON

'Send ":FETCH?" to import the most recent measurement  
'Receive

'Write to the file

## ■ Measure Resistance by PC Key

Measures and imports by key input on the PC, and saves measurements in a text file.

```

Private Sub MeasureReadSub()
Dim buffer As String * 20           'Receiving buffer
Dim rcvstr As String               'Receiving char string
Dim pad As Integer                 'Controller Address
Dim gpibad As Integer              'Device Address
Dim timeout As Integer             'Timeout period
Dim ud As Integer                  'State (unused)
Dim i As Integer

pad = 0                             'Board Address 0
gpibad = 1                          'RM3543Address 1
timeout = T10s                       'Timeout about 10s

Call ibfind("gpib0", 0)              'Initialize GP-IB
Call ibdev(pad, gpibad, 0, timeout, 1, 0, ud)
Call SendIFC(pad)
Open App.Path & "\data.csv" For Output As #1 'Open a text file for saving

Call Send(pad, gpibad, ":TRIG:SOUR IMM", NLEnd) 'Select internal triggering
Call Send(pad, gpibad, ":INIT:CONT OFF", NLEnd) 'Continuous measurement OFF
For i = 1 To 10
  'Wait for PC key input
  'Create a key input check routine to set InputKey() = True when a key is pressed

  Do While 1
    If InputKey() = True Then Exit Do
    DoEvents
  Loop

  'After confirming key input, measure once, and read the measured value
  Call Send(pad, gpibad, ":READ?", NLEnd) 'Send ":READ?" to measure and import the measurement
  Call Receive(pad, gpibad, buffer, STOPend) 'Receive
  rcvstr = Left(buffer, InStr(1, buffer, Chr(10)) - 1)
  Print #1, Str(i) & ", " & rcvstr 'Write to the file
Next

Close #1
Call ibonl(pad, 0)
End Sub

```

## ■ External Trigger Measurement 1

Measure and import according to external triggering of the RM3543 (F4 [MANU] key or  $\overline{\text{TRIG}}$  signal input), and save measurements in a text file.

Private Sub MeasureTrigSub()	
Dim buffer As String * 20	'Receiving buffer
Dim recvstr As String	'Receiving char string
Dim pad As Integer	'Controller Address
Dim gpibad As Integer	'Device Address
Dim timeout As Integer	'Timeout period
Dim ud As Integer	'State (unused)
Dim i As Integer	
pad = 0	'Board Address 0
gpibad = 1	'RM3543 Address 1
timeout = T100s	'Timeout 100s (because of external trigger wait state)
Call ibfind("gpib0", 0)	'Initialize GP-IB
Call ibdev(pad, gpibad, 0, timeout, 1, 0, ud)	
Call SendIFC(pad)	
Open App.Path & "data.csv" For Output As #1	'Open a text file for saving
Call Send(pad, gpibad, ":TRIG:SOUR EXT", NLen)	'Select external triggering
Call Send(pad, gpibad, ":INIT:CONT OFF", NLen)	'Continuous measurement OFF
For i = 1 To 10	
Call Send(pad, gpibad, ":READ?", NLen)	'Send ":READ?" to measure and import the measurement
Call Receive(pad, gpibad, buffer, STOPend)	'Receive
recvstr = Left(buffer, InStr(1, buffer, Chr(10)) - 1)	
Print #1, Str(i) & "," & recvstr	'Write to the file
Next	
Close #1	
Call ibonl(pad, 0)	
End Sub	

## ■ External Trigger Measurement 2

Measure and import according to external triggering of the RM3543 (F4 [MANU] key or  $\overline{\text{TRIG}}$  signal input), and save measurements in a text file.

(The RM3543 imports the most recent measurement by trigger input timing with the continuous measurement state)

```

Private Sub MeasureTrig2Sub()
Dim buffer As String * 20           'Receiving buffer
Dim rcvstr As String               'Receiving char string
Dim pad As Integer                 'Controller Address
Dim gpibad As Integer              'Device Address
Dim timeout As Integer             'Timeout period
Dim ud As Integer                  'State (unused)
Dim i As Integer

pad = 0                             'Board Address 0
gpibad = 1                          'RM3543 Address 1
timeout = T100s                     'Timeout 100s (because of external trigger wait state)

Call ibfind("gpib0", 0)             'Initialize GP-IB
Call ibdev(pad, gpibad, 0, timeout, 1, 0, ud)
Call SendIFC(pad)
Open App.Path & "data.csv" For Output As #1 'Open a text file for saving

Call Send(pad, gpibad, ":TRIG:SOUR IMM", NLen) 'Select internal triggering
Call Send(pad, gpibad, ":INIT:CONT ON", NLen) 'Continuous measurement ON

'Clear confirmation of External I/O TRIG input
Call Send(pad, gpibad, ":IO:IN?", NLen)
Call Receive(pad, gpibad, buffer, STOPend)
rcvstr = Left(buffer, InStr(1, buffer, Chr(10)) - 1)
For i = 1 To 10
  'Wait for External I/O TRIG input
  Do While 1
    Call Send(pad, gpibad, ":IO:IN?", NLen)
    Call Receive(pad, gpibad, buffer, STOPend)
    If Left(buffer, 1) = "1" Then Exit Do
    DoEvents
  Loop

  Call Send(pad, gpibad, ":FETCH?", NLen) 'Send ":FETCH?" to import the most recent
                                         'measurement
  Call Receive(pad, gpibad, buffer, STOPend) 'Receive
  rcvstr = Left(buffer, InStr(1, buffer, Chr(10)) - 1)
  Print #1, Str(i) & ", " & rcvstr        'Write to the file
Next

Close #1
Call ibonl(pad, 0)
End Sub

```



## ■ Set Measurement State

Sets up the measurement setting state.

```
'Measurement Setting Configuration
'Configures instrument settings for measurement
'Function: Resistance Measurement
'Range: 1Ω
'Sampling: FAST
'Triggering: External trigger
'Comparator enabled, REF% mode, reference value 1 Ω, tolerance +1.0% / -1.5%, beep upon Hi or Lo
Private Sub SettingsSub()
Dim pad As Integer           'Controller Address
Dim gpibad As Integer       'Device Address
Dim timeout As Integer      'Timeout period
Dim ud As Integer           'State (unused)

pad = 0                     'Board Address 0
gpibad = 1                  'RM3543 Address 1
timeout = T10s              'Timeout about 10s

Call ibfind("gpib0", 0)     'Initialize GP-IB
Call ibdev(pad, gpibad, 0, timeout, 1, 0, ud)
Call SendIFC(pad)

Call Send(pad, gpibad, ":FUNC RES", NLEnd) 'Select Resistance function
Call Send(pad, gpibad, ":RES:RANG 1E+0", NLEnd) 'Select 1000 mΩ range
Call Send(pad, gpibad, ":SPEE FAST", NLEnd) 'Select FAST sampling
Call Send(pad, gpibad, ":TRIG:SOUR EXT", NLEnd) 'Select external triggering
Call Send(pad, gpibad, ":INIT:CONT ON", NLEnd) 'Continuous measurement ON
Call Send(pad, gpibad, ":CALC:LIM:MODE REF", NLEnd) 'From here on, comparator settings
Call Send(pad, gpibad, ":CALC:LIM:BEEP HL", NLEnd)
Call Send(pad, gpibad, ":CALC:LIM:REF 1E+0", NLEnd)
Call Send(pad, gpibad, ":CALC:LIM:PERC 1.0, -1.5", NLEnd)
Call Send(pad, gpibad, ":CALC:LIM:STAT ON", NLEnd) 'Comparator ON

Call ibonl(pad, 0)
End Sub
```

**Creation Procedure (Visual Basic® 2005)**

This section describes an example of how to use the Windows® development language Visual Basic®2005 Express Edition to operate the RM3543 unit from a PC via RS-232C, incorporate measurement values, and save measurement values to a file.

**NOTE**

Depending on the environment of the PC and Visual Basic®2005, the procedure may differ slightly from the one described here. For a detailed explanation on how to use Visual Basic®2005, refer to the instruction manual or Help of Visual Basic®2005.

- 1 Startup Visual Basic®2005, select [ **Windows Application** ] from [ **File** ] - [ **New Project** ] (a), and click the “**OK**” button (b).

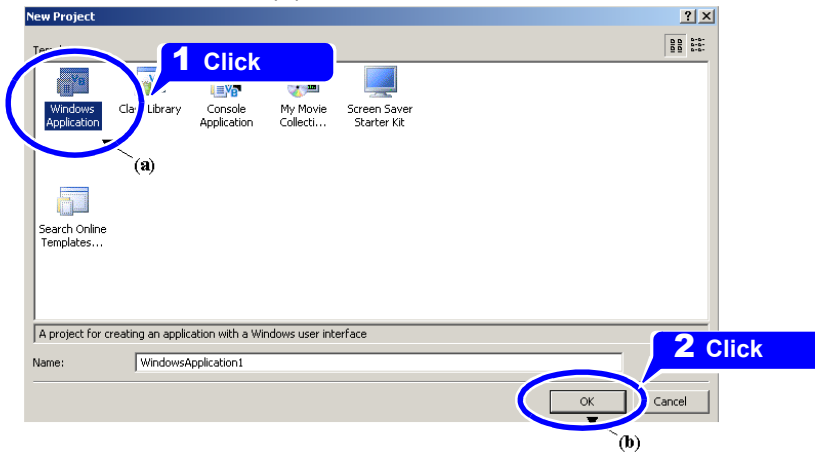

- 2 Click on the common control [ **Button** ] icon (a), and then drag the mouse over the form layout window (b) to insert the button.

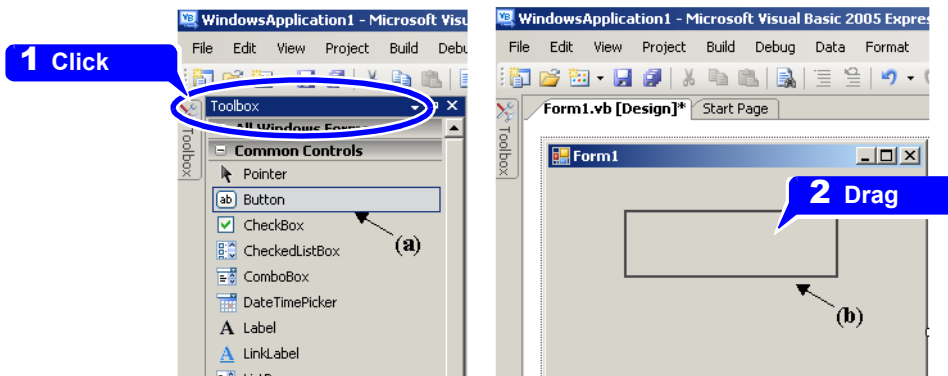

- 3** Use the method in step 2 to create another button, and edit the text in the property window of each button to appear as in the diagram.

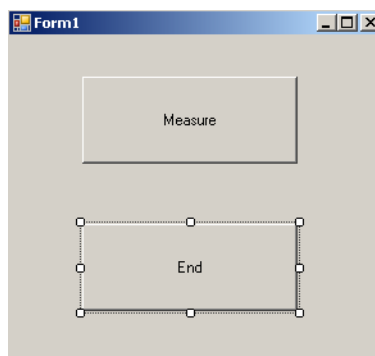

- 4** Right-click above [ **Form1** ] in the solution explorer, and select [ **View Code** ].

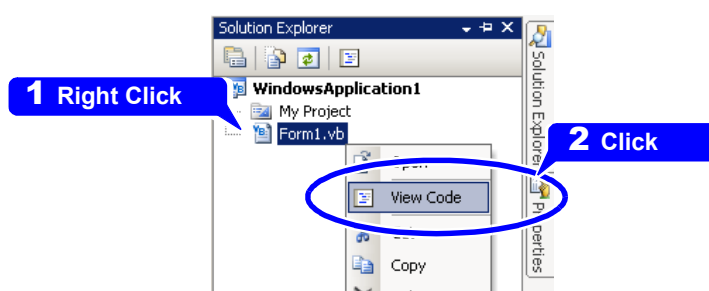

Follow the procedure below so that the Visual Basic®2005 window becomes as shown in the diagram below. Write a program referring to Sample program (p. 166), and execute the created program.

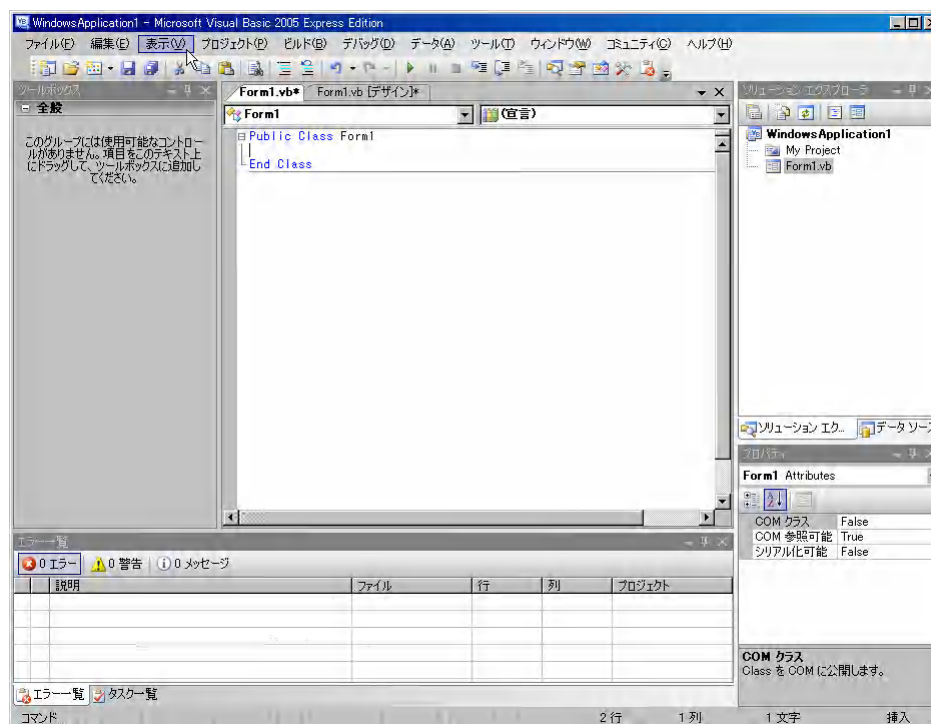

## Sample Programs (Visual Basic® 2005)

Shown below is a sample program which uses Visual Basic®2005 to enact RS-232C communication, set the RM3543 measurement conditions, read measurement results and then save them to file. The sample program will be written in the following manner.

Creation Procedure (Visual Basic 2005) description	Write using sample program
Button created to begin measurement	Button1
Button created to close application	Button2

When the [ Begin Measurement ] is pressed, the RM3543 takes 10 measurements and writes the measurement values to a [ data.csv ] file.

When the [ Quit ] button is pressed the program closes.

The following program is written entirely in [ Form1 ] code.

```
Imports System
Imports System.IO
Imports System.IO.Ports

Public Class Form1
'Perform process when Button1 is pressed
Private Sub Button1_Click(ByVal sender As System.Object, ByVal e As System.EventArgs) Handles Button1.Click
Dim recvstr As String
Dim i As Integer

Try
Button1.Enabled = False           'Disable buttons during communication..... (a)
Button2.Enabled = False
Dim sp As New SerialPort("COM1", 9600, Parity.None, 8, StopBits.One) 'Communication port setting ..... (b)
sp.NewLine = vbCrLf              'Terminator setting..... (c)
sp.ReadTimeout = 2000            '2 second time out ..... (d)
sp.Open()                        'Open port
SendSetting(sp)                  'RM3543 settings
FileOpen(1, "data.csv", OpenMode.Output) 'Create text file to be saved ..... (e)
For i = 1 To 10
sp.WriteLine("*FETCH?")         'Begin measurement and read measurement results command..... (f)
recvstr = sp.ReadLine()         'Read measurement results
WriteLine(1, recvstr)           'Write to file
Next i
FileClose(1)                     'Close file
sp.Close()                       'Close port
Button1.Enabled = True
Button2.Enabled = True
Catch ex As Exception
MessageBox.Show(ex.Message, "Error", MessageBoxButtons.OK, MessageBoxIcon.Error)
End Try

End Sub
'Set measurement conditions
Private Sub SendSetting(ByVal sp As SerialPort)
Try
sp.WriteLine(":TRIG:SOUR IMM") 'Select internal triggering
sp.WriteLine(":INIT:CONT ON") 'Continuous measurement ON
Catch ex As Exception
MessageBox.Show(ex.Message, "Error", MessageBoxButtons.OK, MessageBoxIcon.Error)
End Try
End Sub
'Close program when Button2 is pressed
Private Sub Button2_Click(ByVal sender As System.Object, ByVal e As System.EventArgs) Handles Button2.Click
Me.Dispose()
End Sub
End Class
```

- (a) This makes it so that during communication the [ Begin Measurement ] and [ Close ] buttons cannot be pressed.
- (b) Matches the RM3543 communication conditions and the computer usage conditions.
  - The port to be used on the computer: 1
  - Transmission speed: 9600 bps
  - Parity: none
  - Data length: 8 bit
  - Stop bit: 1bit
- (c) Sets CR + LF as the terminator indicating the end of the sending and receiving character string.
- (d) Sets the reading operation time to 2 seconds.
- (e) Opens the "data.csv" file. However, if a file with this name already exists, the previous "data.csv" will be deleted and a new file created.
- (f) Sends the command to the RM3543 to perform one measurement and return that measurement result to the computer.

## 9.10 Device Compliance Statement



“Information on compliance to standards” based on the IEEE 488.2 standard

1. IEEE 488.1 interface functions	See: "GP-IB Specifications (Interface Functions) (RM3543-01 only)" (p. 102)
2. Operation with a device address other than 0 through 30	A setting outside the 0 to 30 range cannot be made.
3. Timing of changed device address recognition	A change of address is recognized immediately after changing.
4. Device settings at power on	The status information is cleared, and all other items are preserved. However, the header on/off setting, and response message separator and terminator are all reinitialized.
5. List of message exchange options	<ul style="list-style-type: none"> <li>• Input buffer capacity and operation</li> </ul> <p>See: "Input Buffer" (p. 112)</p> <p>Queries to which multiple response message units are returned</p> <pre> :CALCulate:STATistics:NUMBer? .....2 :CALCulate:STATistics:MAXimum? .....2 :CALCulate:STATistics:MINimum? .....2 :CALCulate:STATistics:LIMit?.....4 :CALCulate:STATistics:DEViation? .....2 :CALCulate:STATistics:CP?.....2 :MEMory:DATA?..... Number of stored values :CALCulate:LIMit:ABS?.....2 :CALCulate:LIMit:PERCent? .....2 :SYSTem:DATE?.....3 :SYSTem:TIME?.....3 </pre> <ul style="list-style-type: none"> <li>• Queries producing responses as syntax checking is performed: <ul style="list-style-type: none"> <li>All queries produce responses when syntax checking is performed.</li> </ul> </li> <li>• Whether any queries produce responses when read: <ul style="list-style-type: none"> <li>There are no queries which produce response messages at the instant they are read in by the controller.</li> </ul> </li> <li>• Whether any commands are coupled: <ul style="list-style-type: none"> <li>There are no relevant commands.</li> </ul> </li> </ul>
6. Summary of functional elements for use when constructing device specific commands, and whether compound commands or program headers can be used:	<p>The followings can be used</p> <ul style="list-style-type: none"> <li>• Program message</li> <li>• Program message terminator</li> <li>• Program message unit</li> <li>• Program message unit separator</li> <li>• Command message unit</li> <li>• Query message unit</li> <li>• Command program header</li> <li>• Query program header</li> <li>• Program data</li> <li>• Character program data</li> <li>• Decimal program data</li> <li>• Compound commands and program headers</li> </ul>
7. Buffer capacity limitations for block data	Block data is not used.

8. Summary of program data elements used in expressions, and deepest nesting level allowable in sub-expressions, including syntax restrictions imposed by the device.	Sub-expressions are not used. Character data and decimal data are the only program data elements used.
9. Response syntax for queries	See: "9.7 Message Reference" (p. 126)
10. Transmission congestion relating to device-to-device messages which do not conform to the general principles for basic response messages	There are no device to device messages.
11. Response capacity for block data	Block data does not appear in responses.
12. Summary of standard commands and queries used	See: "9.6 Message List" (p. 120)
13. Device state after a calibration query has been completed without any problem	The " <b>*CAL?</b> " query is not used.
14. Existence/nonexistence of " <b>*DDT</b> " command	The " <b>*DDT</b> " command is not used.
15. Existence/nonexistence of macro command	Macros are not used.
16. For queries related to identification, explanation of the response to the " <b>*IDN?</b> " query	See: "Standard Commands" (p. 127)
17. Capacity of the user data storage area reserved for when the " <b>*PUD</b> " command and the " <b>*PUD?</b> " query are being executed	The " <b>*PUD</b> " command and the " <b>*PUD?</b> " query are not used. Further, there is no user data storage area.
18. Resources when the " <b>*RDT</b> " command and the " <b>*RDT?</b> " query are being used	The " <b>*RDT</b> " command and the " <b>*RDT?</b> " query are not used. Further, there is no user data storage area.
19. Conditions which are influenced when " <b>*RST</b> ", " <b>*LRN?</b> ", " <b>*RCL?</b> ", and " <b>*SAV</b> " are used	" <b>*LRN?</b> ", " <b>*RCL?</b> ", and " <b>*SAV</b> " are not used. The " <b>*RST</b> " command returns the unit to its initial state. See: "Standard Commands" (p. 127), "Initialization Items" (p. 118)
20. Scope of the self-testing executed as a result of the " <b>*TST?</b> " query	See: "Standard Commands"; " <b>*TST?</b> " (p. 127)
21. Additional organization of the status data used in a device status report	See: "Event Registers" (p. 115)
22. Whether commands are overlap or sequential type	All the commands are sequential commands.
23. Criterion relating to the functions required at the instant that the termination message is produced, as a response to each command	Termination occurs when the command has been parsed. The <b>:READ?</b> query finishes when the measurement data is received.





# Specifications Chapter 10

## Measurement Ranges

0.00000 mΩ (10 mΩ range) to 1200.000 Ω (in 6 ranges)

## Measurement Method

<b>Measurement signal</b>	Constant current
<b>Measurement method</b>	Four-terminal
<b>Measurement jacks</b>	BNC female, 22 mm pitch H <sub>CUR</sub> jack Current sourcing terminal H <sub>POT</sub> jack High-side voltage detection terminal L <sub>POT</sub> jack Low-side voltage detection terminal L <sub>CUR</sub> jack Current detection terminal GUARD jack (measurement ground potential)

## Functions

### (1) Comparator Function

<b>Operation</b>	Compares setting and measured values
<b>Default state</b>	ON Reference value 1000 Ω, Upper limit value 0.000%, Lower limit value 0.000% REF% mode
<b>Setting</b>	ON / OFF
<b>Comparator mode</b>	REF%/ ABS
<b>Decision</b>	Decisions include any fraction of least-significant display digit Hi Measurement value > Upper limit value IN Upper limit value ≥ measurement value ≥ Lower limit value Lo Lower limit value > measurement value

### REF% Mode

<b>Display</b>	Absolute and relative value display Relative value = $\left( \frac{\text{Measurement value}}{\text{Reference value}} - 1 \right) \times 100 [\%]$
<b>Displayable range</b>	-999.999% to +999.999%
<b>Reference value range</b>	0.0000 mΩ to 1200.0 Ω
<b>Upper/Lower limit ranges</b>	-9.999% to +9.999% (when  Upper limit value  and  Lower limit value  are 10% or less) -99.99% to +99.99% (when  Upper limit value  or  Lower limit value  is more than 10%)

### ABS Mode

<b>Upper/Lower limit ranges</b>	0.0000 mΩ to 1200.00 Ω
---------------------------------	------------------------

**(2) Range Switching**

<b>Comparator On</b>	Per following table Table 1. Ranges of reference (REF%) tolerance and upper limit (ABS) values														
	<table border="1"> <thead> <tr> <th>Range of reference (REF%) and upper limit (ABS) values</th> <th>Selected Range</th> </tr> </thead> <tbody> <tr> <td>0 to 10.009 mΩ</td> <td>10 mΩ</td> </tr> <tr> <td>10.01 to 100.09 mΩ</td> <td>100 mΩ</td> </tr> <tr> <td>100.1 to 1000.9 mΩ</td> <td>1000 mΩ</td> </tr> <tr> <td>1.001 to 10.009 Ω</td> <td>10 Ω</td> </tr> <tr> <td>10.01 to 100.09 Ω</td> <td>100 Ω</td> </tr> <tr> <td>100.1 to 1200.0 Ω</td> <td>1000 Ω</td> </tr> </tbody> </table>	Range of reference (REF%) and upper limit (ABS) values	Selected Range	0 to 10.009 mΩ	10 mΩ	10.01 to 100.09 mΩ	100 mΩ	100.1 to 1000.9 mΩ	1000 mΩ	1.001 to 10.009 Ω	10 Ω	10.01 to 100.09 Ω	100 Ω	100.1 to 1200.0 Ω	1000 Ω
Range of reference (REF%) and upper limit (ABS) values	Selected Range														
0 to 10.009 mΩ	10 mΩ														
10.01 to 100.09 mΩ	100 mΩ														
100.1 to 1000.9 mΩ	1000 mΩ														
1.001 to 10.009 Ω	10 Ω														
10.01 to 100.09 Ω	100 Ω														
100.1 to 1200.0 Ω	1000 Ω														
	Manual setting is available on the Basic Settings screen.														
<b>Comparator Off</b>	The range is selected by Range key														
<b>Default setting</b>	1000 Ω range														

**(3) Measurement Current Switching**

<b>Measurement current</b>	100 mΩ range: 100 mA/ 1 A
<b>Default state</b>	100 mA

**(4) Delay Setting****DELAY1**

<b>Operation</b>	Adjusts the mechanical delay of trigger input and probing (setting affects all ranges) When using the internal trigger, add 100 ms to the setting (to prevent heat generation).
<b>Default state</b>	0.0 ms
<b>Setting range</b>	0.0 ms to 100.0 ms

**DELAY2**

<b>Operation</b>	Adjusts measurement object response (for each range)
<b>Default state</b>	0.0 ms
<b>Setting range</b>	0.0 ms to 100.0 ms

**(5) OVC (Offset Voltage Compensation)**

<b>Operation</b>	Reverses measurement current polarity to eliminate offset voltage effects
<b>Applicable ranges</b>	10 mΩ to 1000 Ω range (All ranges)

## (6) Integration Time Setting

<b>Operation</b>	Sets the voltage detection acquisition time span (for each range)																																											
<b>Default state</b>	Table 2. Integration Time Settings																																											
	<table border="1"> <thead> <tr> <th rowspan="2">Range</th> <th colspan="3">Integration Time</th> <th rowspan="2">OVC</th> </tr> <tr> <th>FAST</th> <th>MED</th> <th>SLOW</th> </tr> </thead> <tbody> <tr> <td>10mΩ</td> <td>2.0 ms</td> <td>5.0 ms</td> <td>1PLC</td> <td>ON</td> </tr> <tr> <td>100mΩ (1A)</td> <td>1.0 ms</td> <td>5.0 ms</td> <td>1PLC</td> <td>ON</td> </tr> <tr> <td>100mΩ (100mA)</td> <td>0.5 ms</td> <td>5.0 ms</td> <td>1PLC</td> <td>ON</td> </tr> <tr> <td>1000mΩ</td> <td>0.3 ms</td> <td>2.5 ms</td> <td>1PLC</td> <td>ON</td> </tr> <tr> <td>10Ω</td> <td>0.3 ms</td> <td>2.5 ms</td> <td>1PLC</td> <td>ON</td> </tr> <tr> <td>100Ω</td> <td>0.3 ms</td> <td>1.5 ms</td> <td>1PLC</td> <td>ON</td> </tr> <tr> <td>1000Ω</td> <td>0.3 ms</td> <td>1.5 ms</td> <td>1PLC</td> <td>ON</td> </tr> </tbody> </table>	Range	Integration Time			OVC	FAST	MED	SLOW	10mΩ	2.0 ms	5.0 ms	1PLC	ON	100mΩ (1A)	1.0 ms	5.0 ms	1PLC	ON	100mΩ (100mA)	0.5 ms	5.0 ms	1PLC	ON	1000mΩ	0.3 ms	2.5 ms	1PLC	ON	10Ω	0.3 ms	2.5 ms	1PLC	ON	100Ω	0.3 ms	1.5 ms	1PLC	ON	1000Ω	0.3 ms	1.5 ms	1PLC	ON
Range	Integration Time			OVC																																								
	FAST	MED	SLOW																																									
10mΩ	2.0 ms	5.0 ms	1PLC	ON																																								
100mΩ (1A)	1.0 ms	5.0 ms	1PLC	ON																																								
100mΩ (100mA)	0.5 ms	5.0 ms	1PLC	ON																																								
1000mΩ	0.3 ms	2.5 ms	1PLC	ON																																								
10Ω	0.3 ms	2.5 ms	1PLC	ON																																								
100Ω	0.3 ms	1.5 ms	1PLC	ON																																								
1000Ω	0.3 ms	1.5 ms	1PLC	ON																																								
	Integration time is doubled when OVC is enabled.																																											
<b>Setting range</b>	0.1 ms to 100.0 ms, per PLC* setting 1 to 5PLC: 50 Hz, 1 to 6PLC: 60 Hz *PLC: Power Line Cycle, One power line cycle (at 50 or 60 Hz)																																											

## (7) Averaging function

<b>Operation</b>	Moving average (during internal trigger measurement) or simple average (during external trigger measurement) (for each range)
<b>Default state</b>	OFF, No. of averaging iterations: 16Times
<b>Setting</b>	ON/ OFF
<b>Number of averaging iterations</b>	2 to 32 times

## (8) Faulty Measurement Detection

### Out-of-Range Detection Function

<b>Operation</b>	Indicates under- or over-range values in the following conditions: <ul style="list-style-type: none"> <li>• Measured value is outside of the measurement range</li> <li>• The relative calculation value is outside of the display range</li> <li>• Measured value is outside of the A/D converter input range</li> <li>• The zero-adjusted value is outside of the display range</li> </ul> Ex.: In the 1 Ω range with 0.5 Ω zero-adjustment in effect, a measurement of 0.1 Ω provides a zero-adjusted value of -0.4 Ω, which is outside of the display range.
------------------	--

### Contact Check Function

<b>Operation</b>	Checks the connections between H <sub>POT</sub> and H <sub>CUR</sub> , and between L <sub>POT</sub> and L <sub>CUR</sub> terminals (for each range)
<b>Default state</b>	ON, 100 Ω
<b>Setting</b>	ON/ OFF
<b>Threshold setting</b>	50 Ω/ 100 Ω/ 150 Ω/ 200 Ω/ 300 Ω/ 400 Ω/ 500 Ω (reference value)

### Current Monitor Function

<b>Operation</b>	Detects faults that can obstruct normal measurement current. This function cannot be disabled.
------------------	--

## Voltage Level Monitor Function

<b>Operation</b>	Detects an error when the detection voltage is unstable (for each range)
<b>Default state</b>	ON, Normal
<b>Setting</b>	ON / OFF
<b>Threshold setting</b>	Loose Normal Severe

## Comparator Decision and Display Indications

Table 3. Measurement States and Display Indications

		Constant Current Monitor	
		PASS	FAIL
Contact Check Voltage Level Monitor	PASS	Measurement value is displayed Normal Decision	Out-of-Range Display Hi Decision
	FAIL	Contact Error No Decision	Contact Error No Decision

## (9) Probe Short-Circuit Detection

<b>Operation</b>	An error is detected within a certain period after $\overline{EOM}$ signal output if a connection lasting more than 1 ms is found between $H_{POT}$ and $H_{CUR}$ or $L_{POT}$ and $L_{CUR}$ terminals.
<b>Default state</b>	OFF, 5 ms
<b>Setting</b>	ON / OFF Test timing is 1 ms to 100 ms
<b>Threshold</b>	500 $\Omega$ fixed (reference value)

## (10) Contact Improvement Function (Contact Improver)

<b>Operation</b>	Applies a contact improvement current (at oxidized film breakdown voltage) between the $H_{POT}$ and $H_{CUR}$ , and the $L_{POT}$ and $L_{CUR}$ terminals. (for each range) The PULSE setting applies the contact improvement current for only 100 $\mu$ s before measuring.
<b>Default state</b>	ON, Current-limited to 35 mA
<b>Setting</b>	OFF/ ON/ PULSE
<b>Applied voltage</b>	20 $V_{MAX}$
<b>Current limit</b>	17 mA, 25 mA, 35 mA, 50 mA (peak current reference value)

## (11) Current Mode Setting

<b>Operation</b>	Enable if measurement current flows when not measuring. (for each range) The CONT (continuous) setting is available only when the Contact Improver function is disabled.
<b>Default state</b>	PULSE
<b>Setting</b>	CONT/ PULSE

**(12) Scaling Function**

<b>Operation</b>	Measured values are corrected with the linear function $y=ax+b$ . (for each range)
<b>Default state</b>	OFF, $a=1$ , $b=0$
<b>Setting</b>	ON/ OFF
<b>Coefficient a</b>	0.50000 to 2.00000
<b>Offset b</b>	$\pm 10\%$ for each range

**(13) Zero Adjustment**

<b>Operation</b>	Nullifies wiring resistance when measuring with the two-terminal method.
<b>Default state</b>	OFF, $0\ \Omega$
<b>Adjustment range</b>	-1 to $10\ \Omega$

**(14) Measurement-Start Logic Setting**

<b>Operation</b>	Sets $\overline{\text{TRIG}}$ signal logic for EXT I/O
<b>Default state</b>	ON edge
<b>Setting</b>	OFF edge/ ON edge

**(15) EOM Pulse Width Setting**

<b>Default state</b>	PULSE Pulse width 5 ms
<b>Setting</b>	HOLD/ PULSE, 1 ms to 100 ms

**(16) Data Output Function**

<b>Operation</b>	Measured values are automatically output when measurement is finished.
<b>Default state</b>	OFF
<b>Setting</b>	ON/ OFF

**(17) Output Data Format Setting**

<b>Default state</b>	ASCII
<b>Setting</b>	ASCII/ BINARY

**(18) Comparator Beeper Setting**

<b>Default state</b>	OFF, HIGH, or LOW
<b>Audibility</b>	ON/ OFF
<b>Signaling criteria</b>	HIGH/ LOW/ HIGH or LOW/ IN

**(19) Key-Press Beeper Setting**

<b>Default state</b>	ON
<b>Setting</b>	ON/ OFF

**(20) Clock**

Auto calendar, auto leap year, 24-hour clock	
Accuracy	Approx. 4 minutes/month
Default state	01/01/2011, 00:00:00
Backup battery life	Approx. 10 years (23°C reference value)

**(21) Power Line Frequency Setting**

Operation	Selects the line voltage frequency
Default state	AUTO (auto-detect upon power on and resetting)
Setting	AUTO (50 or 60 Hz, fixed)/ 50 Hz / 60 Hz

**(22) Reset Functions****Reset**

Operation	Resets settings (except the clock) to factory defaults
-----------	--

**\*RST (Remote command)**

Operation	Resets settings (except the clock and interface) to factory defaults When power is restored, reverts to the settings before *RST was sent
-----------	--

**(23) Self-Calibration Function**

Operation	Compensates for offset voltage and gain of measurement circuit
Compensation timing	When setting is changed and once every 10 minutes

**(24) Memory Function**

Operation	Measured values are stored by an EXT I/O $\overline{\text{TRIG}}$ signal or by pressing the F4 [MANU]* button * Displayed when EXT is selected on the [MENU] – [TRG] selection screen
Default state	OFF
Setting	ON/ OFF
Memory capacity	30,000 (volatile memory, no backup)

**(25) Auto-Memory Function**

Operation	When stable, measured values are acquired by internal continuous triggering during manual measurement The beeper sounds when the specified number of measurements is acquired Memory is cleared when acquired data has been transferred or printed by RS-232C During Auto-Memory operation, the statistical calculation function is always enabled. The voltage level monitor function is disabled.
Default state	OFF/ 10
Setting	ON/ OFF Number of measurements stored: 1 to 99

**(26) Statistical Calculations**

<b>Operation</b>	Statistical calculations are performed on measured values in memory.
<b>Default state</b>	OFF
<b>Setting</b>	ON/ OFF
<b>Calculations</b>	Total data count, Mean, Minimum value (sample no.), Maximum value (sample no.), Standard deviation of sample, Population standard deviation, Process capability indices

**(27) Settings Monitor Function**

<b>Operation</b>	Measurement settings of two instruments are compared, and if different, an alarm sounds and $\overline{\text{TRIG}}$ input is inhibited. However, the comparator thresholds of the 1 <sup>st</sup> stage instrument can be smaller than those of the 2 <sup>nd</sup> .
<b>Default state</b>	OFF, 1st, 0.000%
<b>Setting</b>	Function ON / OFF Measurement stages 1st / 2nd Tolerance range 0.000% to 9.999%
<b>Compared contents</b>	Comparator threshold, measurement speed

**(28) Retry Function**

<b>Operation</b>	The Retry function causes measurement to be automatically retried when a measurement fault occurs due to probe chatter. If a measurement fault persists after the specified continuous retry interval, retrying is aborted and the $\overline{\text{EOM}}$ signal is output.
<b>Default state</b>	ON, 50 ms
<b>Setting</b>	Function ON/ OFF Continuous retry interval 1 ms to 50 ms

**(29) Self-Test**

<b>At power-on</b>	ROM/RAM check, non-volatile ROM checksum test
--------------------	---

**(30) Trigger Source Setting**

<b>Default state</b>	EXT (external)
<b>Settings</b>	INT (Internal)/ EXT (external)

**(31) Measurement Speed**

<b>Default state</b>	FAST
<b>Setting</b>	FAST/ MED/ SLOW

**(32) Key-Lock Functions**

<b>Operation</b>	Disables operation of unneeded keys.
<b>Setting</b>	(1) Disables all except the comparator setting and cancel keys (2) Disables all except the cancel key (3) All front panel keys are disabled when the $\overline{\text{KEY\_LOCK}}$ signal is received.

**(33) Remote Control**

<b>Operation</b>	During REMOTE operation by RS-232C or GP-IB, all front panel operations are disabled.
<b>Cancellation methods</b>	F1 [LOCAL] key By RS-232C : SYSTem:LOCAl command By GP-IB GTL command Reset At power-on

**Interface****(1) Display**

<b>Monochrome graphical</b>	LCD 240 × 64
<b>Backlight</b>	White LED Brightness adjustment range 0 to 100% When using EXT trigger source, brightness is automatically reduced when keys are not used. Brightness recovers upon front panel key operation.
<b>Contrast</b>	Adjustment range 0 to 100%

**(2) Keys**

<p>⏻, REF%, ABS, 0, 1, 2, 3, 4, 5, 6, 7, 8, 9, +/-, BACK SPACE, Period, ENTER, ESC, mΩ, Ω, kΩ, MΩ, %, ▼, ▲, ►, ◀, F1, F2, F3, F4</p>
--

**(3) External Interface****EXT I/O**

<b>Input Signals</b>	$\overline{\text{TRIG}}$ , $\overline{\text{HOLD}}$ , $\overline{\text{KEY\_LOCK}}$ , $\overline{\text{0ADJ}}$ , $\overline{\text{PRINT}}$ , $\overline{\text{CAL}}$ , $\overline{\text{PRB\_CHECK}}$ Optocoupler-isolated no-voltage contact inputs L voltage (assert): 0 to 1 V (3 mA input current (reference value)) H voltage (de-assert): OPEN or 5 V to 30 V
<b>Output Signals</b>	$\overline{\text{HI}}$ , $\overline{\text{IN}}$ , $\overline{\text{LO}}$ , $\overline{\text{EOM}}$ , $\overline{\text{INDEX}}$ , $\overline{\text{ERR}}$ , $\overline{\text{PRB\_SHORT}}$ , $\overline{\text{CE\_HI}}$ , $\overline{\text{CE\_LO}}$ Optocoupler-isolated npn open-collector output $V_{\text{CE}}$ DC30 $V_{\text{MAX}}$ Residual voltage 1.5 V or less ( $I_{\text{C}} = 50 \text{ mA}$ ) / 1 V or less ( $I_{\text{C}} = 10 \text{ mA}$ ) $I_{\text{C}}$ 50 $\text{mA}_{\text{MAX}}/\text{ch}$
<b>External power output</b>	(1) 4.5 to 5 V, 100 $\text{mA}_{\text{MAX}}$ 11 to 13 V, 20 $\text{mA}_{\text{MAX}}$ <ul style="list-style-type: none"> <li>• However, loads cannot be drawn from the +5 V and +12 V power supplies at the same time.</li> </ul> (2) Isolation: Floating from protective ground potential and measurement circuit Insulation rating vs. ground: not more than 50 VDC, 30 V rms AC, and 42.4 V pk AC



## RS-232C

<b>Communication contents</b>	Remote control, measured value output (export)
<b>Transfer method</b>	Asynchronous, Full duplex
<b>Transmission speed</b>	9,600bps (default setting)/ 19,200bps/ 38,400bps
<b>Data length</b>	8 bit
<b>Stop bit</b>	1
<b>Parity</b>	none
<b>Delimiter</b>	Transmit CR+LF, Receive CR or CR+LF
<b>Handshaking</b>	No X-flow, no hardware flow
<b>Protocol</b>	Non-procedure
<b>Connector</b>	Male 9-pin D-sub, with #4-40 attachment screws

## Printer

<b>Printing Contents</b>	Measurement data ( $\overline{\text{PRINT}}$ signal input), Total data count, Mean, Minimum value (sample no.), Maximum value (sample no.), Standard deviation of sample, Population standard deviation, Process capability, No. of IN, No. of Hi and Lo, No. of OvrRng, No. of Measurement faults	
<b>Communications</b>	Communications method	Asynchronous RS-232C
	Transmission speed	9,600bps
	Data length	8 bits
	Stop bit	1 bit
	Parity	none
	Delimiter	Transmit CR+LF, Receive CR or CR+LF
	Handshake	No X-flow, no hardware flow

## GP-IB interface (RM3543-01 only)

<b>Communication contents</b>	Remote control
<b>Interface Functions</b>	<p>SH1 All Source Handshake functions are supported.</p> <p>AH1 All Acceptor Handshake functions are supported.</p> <p>T6 Basic talker functions are supported. Serial poll function are supported. No talk-only mode. The talker cancel function with MLA (My Listen Address) is supported.</p> <p>L4 Basic listener functions are supported. No listen-only mode. The listener cancel function with MTA (My Talk Address) is supported.</p> <p>SR1 All Service Request functions are supported.</p> <p>RL1 All Remote/Local functions are supported.</p> <p>PP0 No Parallel Poll function.</p> <p>DC1 All Device Clear functions are supported.</p> <p>DT1 All Device Trigger functions are supported.</p> <p>C0 No Controller functions are supported.</p>
<b>Miscellaneous</b>	Conforms to IEEE 488.2

## Settings Monitor terminal (SET MONITOR)

<b>Connector</b>	Male 9-pin D-sub, with #4-40 attachment screws
<b>Connection cable</b>	Crossover

### Measurement Specifications

#### (1) Resistance Measurement Accuracy

##### Conditions of guaranteed accuracy

**Warm-up time** At least 30 minutes

**Integration time** Set longer than the initial "Integration Time Setting" (p. 173) for the default PLC setting, unspecified for ms setting

**Temperature and humidity range for guaranteed accuracy** 23±5°C, 80%RH or less

**Period of guaranteed accuracy** 1 year

Temperature variation after self-calibration is within ±2°C.  
Add thermal coefficient (±1/10th of measurement accuracy per °C) from 0 to 18°C and from 28 to 40°C.

Accuracy ± (%rdg.+%f.s.) (calculated as f.s. = 1,000,000dgt., or 0.001% f.s. = 10dgt.)

Range	Max. Display *1	FAST	MED	SLOW	Measurement Current *2	Open-Terminal Voltage
10mΩ	12.00000 mΩ	0.060 + 0.005	0.060 + 0.003	0.060 + 0.001*4 0.060 + 0.002	1 A	20 V <sub>MAX</sub> *3
100mΩ	120.0000 mΩ	0.060 + 0.003	0.060 + 0.002	0.060 + 0.001	1 A	
100mΩ	120.0000 mΩ	0.015 + 0.008	0.015 + 0.003	0.015 + 0.002	100 mA	
1000mΩ	1200.000 mΩ	0.012 + 0.003	0.012 + 0.002	0.012 + 0.001	100 mA	
10Ω	12.00000 Ω	0.010 + 0.003	0.008 + 0.002	0.008 + 0.001	10 mA	
100Ω	120.0000 Ω	0.009 + 0.003	0.007 + 0.002	0.007 + 0.001	10 mA	
1000Ω	1200.000 Ω	0.008 + 0.003	0.006 + 0.002	0.006 + 0.001	1 mA	

\*1 Negative values can be up to 10% of positive full scale.

\*2 Measurement current accuracy is ±5%

\*3 Less than 20 mV when not measuring, with Pulse current mode and Contact Improver set to OFF or Pulse (by 10-MΩ input-impedance voltmeter)

\*4 When the number of averaging iterations is set to 16 or higher, accuracy is defined for slow measurement in the 10 mΩ range only. For other configurations, accuracy is not dependent on the averaging setting.

- f.s. (maximum display value) The maximum displayable value. This is usually the name of the currently selected range.
- rdg. (reading or displayed value) The value currently being measured and indicated on the measuring instrument.
- dgt. (resolution) The smallest displayable unit on a digital measuring instrument, i.e., the input value that causes the digital display to show a "1" as the least-significant digit.

**(2) Measurement Time (default settings)**

Range	FAST	MED	SLOW
10mΩ Average: 16 times*1	176 ms	272 ms	752 ms 640 ms
10mΩ	11 ms	17 ms	47 ms 40 ms
100mΩ (1A)	5.0 ms	13 ms	43 ms 36 ms
100mΩ (100mA)	3.8 ms	13 ms	43 ms 36 ms
1000mΩ	2.0 ms	6.4 ms	41 ms 35 ms
10Ω	1.6 ms	6.0 ms	41 ms 34 ms
100Ω	1.6 ms	4.0 ms	41 ms 34 ms
1000Ω	1.6 ms	4.0 ms	41 ms 34 ms

Upper value: 50 Hz power line frequency  
Lower value: 60 Hz power line frequency

Tolerance  $\pm 10\% \pm 0.2$  ms  
(Without retry)

\*1 When performing external trigger measurement.  
When performing internal trigger measurement, same as when averaging is off.

**Environment and Safety Specifications**

<b>Operating environment</b>	Indoors, Pollution degree 2, up to 2000 m (6562-ft.) ASL
<b>Storage temperature and humidity</b>	-10°C to 50°C (14 to 122°F), 80%RH or less (non-condensating)
<b>Operating temperature and humidity</b>	0°C to 40°C (32 to 104°F), 80%RH or less (non-condensating)
<b>Dielectric strength</b>	1.62 kV AC for 1 min., Cutoff current 10 mA, between all power terminals and protective ground, interfaces, and measurement jacks
<b>Applicable Standards</b>	
<b>Safety</b>	EN61010
<b>EMC</b>	EN61326 Class A Effect of radiated radio-frequency electromagnetic field: 3%f.s. at 10 V/m Effect of conducted radio-frequency electromagnetic field: 2%f.s. at 3 V
<b>Power source</b>	Rated supply voltage 100 to 240 VAC (Voltage fluctuations of $\pm 10\%$ from the rated supply voltage are taken into account) Rated supply frequency: 50/60 Hz Anticipated transient overvoltage 2,500 V
<b>Maximum rated power</b>	40 VA
<b>Dimensions</b>	Approx. 260W x 88H x 300D mm (10.24"W x 3.46"H x 11.81"D)
<b>Mass</b>	Approx. 3.0 kg (105.8 oz.)
<b>Product warranty</b>	3 years

**Accessories**

- Power Cord (2-line + ground) (1)
- EXT I/O Male Connector (1)
- Instruction Manual (This document) (1)
- Operation Guide (1)

### Options

- Model 9140 4-terminal Probe
- Model 9500 4-terminal Probe
- Model 9262 Test Fixture (less than 10 m $\Omega$  residual resistance after zero adjustment)
- Model 9263 SMD Test Fixture (less than 10 m $\Omega$  residual resistance after zero adjustment)

**Interface Cables:**

- Model 9637 RS-232C Cable (9-pin to 9-pin/ crossover cable)
  - Model 9638 RS-232C Cable (9-pin to 25-pin/ crossover cable)
  - Model 9151-02 GP-IB Connector Cable (2 m)
-

# Maintenance and Service

## Chapter 11

### 11.1 Troubleshooting

#### Inspection and Repair



#### **WARNING**

Do not attempt to modify, disassemble or repair the instrument; as fire, electric shock and injury could result.

#### **NOTE**

- If damage is suspected, check the "Before Returning for Repair" p.184) section before contacting your dealer or Hioki representative.

#### **Transporting**

- Use the original packing materials when transporting the instrument, if possible.
- Pack the instrument so that it will not sustain damage during shipping, and include a description of existing damage. We do not take any responsibility for damage incurred during shipping.

#### **Replaceable Parts and Operating Lifetimes**

Useful life depends on the operating environment and frequency of use. Operation cannot be guaranteed beyond the following periods. For replacement parts, contact your dealer or Hioki representative.

Part	Life
LCD (to half brightness)	Approx. 50,000 hours
Electrolytic Capacitors	Approx. 10 years
Lithium Battery	Approx. 10 years  The instrument contains a built-in backup lithium battery. If the date and time deviate substantially when the instrument is switched on, it is the time to replace that battery. Contact your dealer or Hioki representative.

If no measured value is displayed even when the probes are shorted together, internal damage may have occurred. Contact your dealer or Hioki representative.

## Before Returning for Repair

If abnormal operation occurs, check the following items.

Symptom	Check Items	
The display does not appear when you turn the power on.	<ul style="list-style-type: none"> <li>Is the power cord disconnected?</li> <li>Are connections made correctly?</li> </ul>	Verify that the power cord is connected properly. (p. 22)
Keys do not work.	<ul style="list-style-type: none"> <li>Is any key being held down?</li> <li>Is Key-Lock enabled (M.LOCK or F.LOCK displayed)?</li> <li>Is remote control communication enabled (RMT displayed)?</li> <li>Is the EXT I/O <math>\overline{\text{KEY\_LOCK}}</math> signal asserted (Low level)?</li> </ul>	Verify key operation. Cancel Key-Lock (p. 64)  Switch to local control (p. 108) De-assert the $\overline{\text{KEY\_LOCK}}$ signal (High level).
Measured values are unstable.	<ul style="list-style-type: none"> <li>Are the cables and measurement object adequately shielded?</li> </ul>	"Appendix 3 Unstable Measurement Values" (p. A3)
Measured values are shifted.	<ul style="list-style-type: none"> <li>Is zero-adjust enabled?</li> <li>Are the CUR and POT terminals connected before contacting the measurement object?</li> <li>Is the measured object calibrated correctly?</li> <li>Is the GUARD terminal drawing more than 10 mA? (the GUARD terminal shield may be contacting a BNC terminal)</li> <li>There may be a large thermal emf.</li> </ul>	"3.6 Zero Adjustment" (p. 32)
If the cause is unknown	<ul style="list-style-type: none"> <li>Try performing a system reset (p. 71). All settings are returned to their factory defaults.)</li> </ul>	

## 11.2 Cleaning

### NOTE

- To clean the instrument, wipe it gently with a soft cloth moistened with water or mild detergent. Never use solvents such as benzene, alcohol, acetone, ether, ketones, thinners or gasoline, as they can deform and discolor the case.
- Wipe the LCD gently with a soft, dry cloth.

## 11.3 Error Displays and Remedies

The following messages are displayed when the instrument detects an error or abnormal measurement setting. If repair is necessary, contact your dealer or Hioki representative.

Display	Description	Remedy	
<b>+OvrRng/-OvrRng</b>	Measurement out of range (p. 38)	Select the appropriate range.	
<b>C.E. Hi</b>	Hi wiring contact error (p. 38)	Check for cable breakage and worn out probes.	
<b>C.E. Lo</b>	Lo wiring contact error (p. 38)	Check for cable breakage and worn out probes.	
<b>C.E. Volt</b>	Voltage Level Monitor error (p. 38)	Check for worn out probes. Keep wiring away from nearby equipment.	
<b>ERR:001</b>	<b>LOW limit is higher than UPP limit</b>	Upper limit is below lower limit	Check comparator settings (p. 34).
<b>ERR:002</b>	<b>Exceeding range (From 0Ω to 1200Ω)</b>	Comparator input is out of range. (out-of-range reference value, such as 1000 kΩ)	Check comparator settings (p. 34).
<b>ERR:003</b>	<b>Setting monitor error. (COMP)</b>	Comparator settings are different from the other RM3543.	Make comparator settings the same (p. 56).
<b>ERR:004</b>	<b>Setting monitor error. (SPEED)</b>	SPEED setting is different from the other RM3543.	Make SPEED settings the same (p. 56).
<b>ERR:011</b>	<b>Zero adjustment error. Offset value exceeds 10Ω.</b>	Out of zero-adjust range	Check the zero-adjustment procedure (p. 32).
<b>ERR:021</b>	<b>Probe short error</b>	Short-circuited probe	Check for correct connections (p. 54).
<b>ERR:031</b>	<b>Command error</b>	Command Error	Check for incorrect commands (p. 119).
<b>ERR:032</b>	<b>Execution error</b>	Execution Error	Check the last command and instrument state (p. 119).
<b>ERR:033</b>	<b>RS-232C communication error</b>	I/F Communications Error	Check communication settings and wiring.
<b>ERR:034</b>	<b>Setting monitor communication error</b>	Settings monitor communications error	Check settings monitor settings and wiring (p. 56).
<b>ERR:041</b>	<b>Line frequency detection error</b>	Error detecting the line frequency	Manually set the frequency to match the line (p. 67).
<b>ERR:042</b>	<b>Clock error Reset?(11-01-01 00:00:00) Press F1 Key.</b>	The clock is not set, so pressing F1 [OK] displays the initialized time 11-01-01 00:00:00.	The back-up battery needs to be replaced. Contact your nearest Hioki representative.
<b>ERR:101</b>	<b>Hardware error (Main CPU ROM)</b>	Hardware failure.	Repair is required.
<b>ERR:102</b>	<b>Hardware error (Main CPU RAM)</b>	Hardware failure.	Repair is required.
<b>ERR:103</b>	<b>Hardware error (SRAM)</b>	Hardware failure.	Repair is required.
<b>ERR:104</b>	<b>Hardware error (Adjustment data)</b>	Hardware failure.	Repair is required.
<b>ERR:105</b>	<b>Hardware error (Backup data) Reset? Press F1 Key.</b>	Hardware failure. (back-up data is corrupted)	Repair is required. Press F1 [OK] to resets the instrument.
<b>ERR:106</b>	<b>Hardware error (Meas CPU communication)</b>	Hardware failure.	Repair is required.
<b>ERR:107</b>	<b>Hardware error (Meas CPU ROM)</b>	Hardware failure.	Repair is required.

### 11.3 Error Displays and Remedies

Display	Description	Remedy
<b>ERR:108</b>	<b>Hardware error (Meas CPU RAM)</b>	Hardware failure. Repair is required.
<b>ERR:109</b>	<b>Hardware error (Measurement end)</b>	Hardware failure. Repair is required.
<b>ERR:110</b>	<b>Hardware error (Zero measurement end)</b>	Hardware failure. Repair is required.
<b>ERR:111</b>	<b>Hardware error (F.S. measurement end)</b>	Hardware failure. Repair is required.
<b>ERR:112</b>	<b>Hardware error (Calibration)</b>	Hardware failure. Repair is required.
<b>ERR:113</b>	<b>Hardware error (Meas CPU A/D data)</b>	Hardware failure. Repair is required.
<b>ERR:114</b>	<b>Hardware error (Meas CPU)</b>	Hardware failure. Repair is required.
<b>ERR:115</b>	<b>Hardware error (FAN Stop)</b>	Hardware failure. Repair is required.
<b>INFO:001</b>	<b>Printing...</b>	Printing in progress. –
<b>INFO:002</b>	<b>Memory full</b>	Memory full. Delete stored data.
<b>INFO:011</b>	<b>Zero adjusting...</b>	Zero-adjust in progress. –
<b>INFO:012</b>	<b>Clearing zero adjustment</b>	Clearing zero-adjust. –
<b>INFO:021</b>	<b>Clear all memory and statistics data?</b>	Confirm deletion of all memory data. (F1:CANCEL/ F2:YES) –
<b>INFO:022</b>	<b>Undo memory and statistics data?</b>	Confirm deletion of one memory data item. (F1:CANCEL/ F2:YES) –
<b>INFO:023</b>	<b>Save and Return? [CANCEL]: Continue to edit.</b>	Confirm MISC setting, or CANCEL to return to previous screen. (F1:CANCEL/ F2:SAVE/ F3:NOSAVE) –
<b>INFO:024</b>	<b>System Reset?</b>	Confirm system reset. (F1:CANCEL/ F4:YES) –
<b>INFO:031</b>	<b>Press enter code.</b>	Waiting for key code entry to access adjustment mode. –
-----	Not measuring When awaiting a trigger after changing settings, and immediately after power-on.	–



## 11.4 Disposing of the Instrument

The instrument uses a lithium battery for back-up power to the clock. When disposing of this instrument, remove the lithium battery and dispose of battery and instrument in accordance with local regulations.

### Removing the Lithium Battery



**WARNING**

To avoid electric shock, turn off the power button and disconnect the power cord and measurement cables before removing the lithium battery.

#### Required tools:

- One Phillips screwdriver (No.1)
- One wire cutter (to remove the lithium battery)

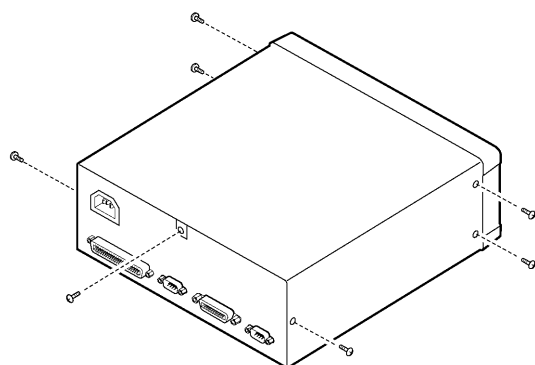

(Overhead View)

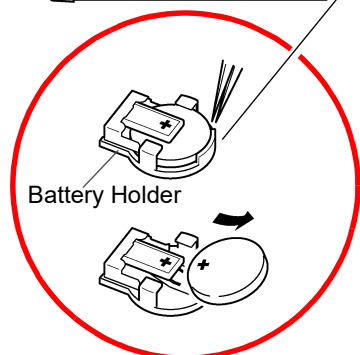
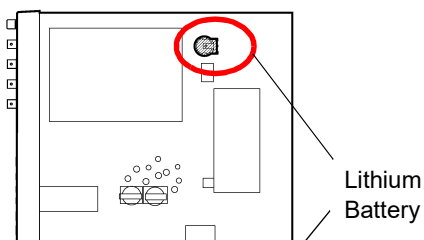

- 1 Verify that the power is off, and remove the connection cables and power cord.
- 2 Remove the six screws from the sides and one screw from the rear.
- 3 Remove the cover.
- 4 Insert the tweezers between the battery and battery holder as shown in the diagram below and lift up the battery.



**CAUTION**

Take care not to short the + and -. Doing so may cause sparks.

#### CALIFORNIA, USA ONLY

This product contains a CR Coin Lithium Battery which contains Perchlorate Material - special handling may apply.

See [www.dtsc.ca.gov/hazardouswaste/perchlorate](http://www.dtsc.ca.gov/hazardouswaste/perchlorate)



# Appendix

## Appendix 1 Four-Terminal (Voltage-Drop) Method

The Four-Terminal method is essential for measuring very small resistance values.

With two-terminal measurements (Fig. 1), the resistance of the test leads is included in the measured resistance, resulting in measurement errors.

The four-terminal method (Fig. 2) consists of current source terminals ( $H_{CUR}$ ,  $L_{CUR}$ ) to provide constant current, and voltage detection terminals ( $H_{POT}$ ,  $L_{POT}$ ) to detect voltage drop.

Because of the high input impedance of the voltmeter, measurement requires practically no current flow through the leads connecting the voltage detection terminals to the test object, practically eliminating the effects of lead and contact resistance on the measurement.

Two-Terminal Measurement Method

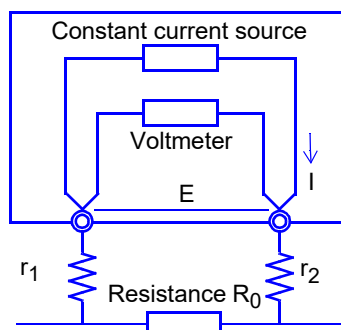

Figure 1.

Measurement current  $I$  flows through test object resistance  $R_0$  as well as lead resistances  $r_1$  and  $r_2$ . The voltage to be measured is obtained by  $E = I(r_1 + R_0 + r_2)$ , which includes lead resistances  $r_1$  and  $r_2$ .

Four-Terminal Measurement Method

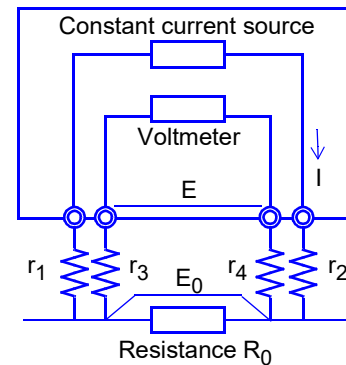

Figure 2.

Current  $I$  flows from  $r_2$  through DUT resistance  $R_0$  and through  $r_1$ . The high input impedance of the voltmeter allows only negligible current flow through  $r_3$  and  $r_4$ . So the voltage drop across  $r_3$  and  $r_4$  is practically nil, and voltage  $E$  across the measurement terminals and voltage  $E_0$  across test object terminals  $R_0$  are essentially equal, allowing test object resistance to be measured without being affected by  $r_1$  to  $r_4$ .

## Appendix 2 Effect of Thermal emf

Thermal emf is the potential difference that occurs at the junction of two dissimilar metals, which if sufficiently large, can cause erroneous measurements. Because this instrument functions by measuring potential difference while applying a constant direct current through the test object, the effect of thermal emf can affect measurements. The amplitude of thermal emf depends on the temperature of the measurement environment, with the force generally being greater at higher temperature.

Thermal emf typically occurs at any junction of dissimilar metals, including between the test probe tips and the test object.

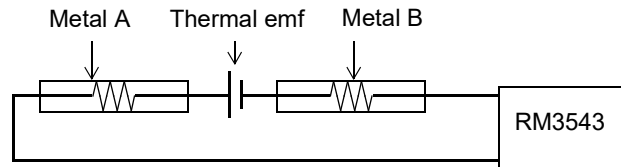

### Measurement discrepancy caused by thermal emf:

(Example)

If the amplitude of electromotive force is  $10\ \mu\text{V}$  and the resistance to be measured is  $1\ \Omega$ , the measurement current of the LP  $1\ \Omega$  range is  $10\ \text{mA}$ , and the actual measured value displayed on the instrument is as follows:  
 $(1\ \Omega \times 10\ \text{mA} + 10\ \mu\text{V}) \div 10\ \text{mA} = 1.00100\ \Omega$

The offset voltage compensation (OVC) function is enabled in all ranges to minimize the effects of thermal emf.

OVC employs the principle that the following value is known to be a true resistance value from  $R_P (>0)$ , the value measured with current flowing in the positive direction, and  $R_N (<0)$ , the value measured with current flowing in the negative direction.

( $R_N$  is a negative value)

$$\frac{R_p - R_N}{2}$$

When the test object has inductance (i.e., is an inductor, etc.), some delay (DELAY2) must be set (p. 42) to allow adequate current flow before starting measurement.

To fine tune the delay, begin with a longer delay than necessary, then gradually shorten it while watching the measured value.

## Appendix 3 Unstable Measurement Values

If the measurement value is unstable, verify the following.

### (1) Effect of Noise from Power Supply Lines

Noise from power supply lines arises from commercial power, and not only from power lines or outlets, but also as radiated emissions from fluorescent lights and home appliances. The frequency of the noise from power supply lines depends on the commercial supplied power frequency, and is typically 50 or 60Hz.

To minimize the affects of this noise from power supply lines, measurements are generally timed to occur at an integer multiple of the supplied power period.

The instrument provides FAST, MEDIUM, and SLOW measurement speed settings.

With the FAST setting, measurements are not synchronized with the power line period, so measurements may be scattered.

In such cases, use the SLOW setting or take noise suppression countermeasures.

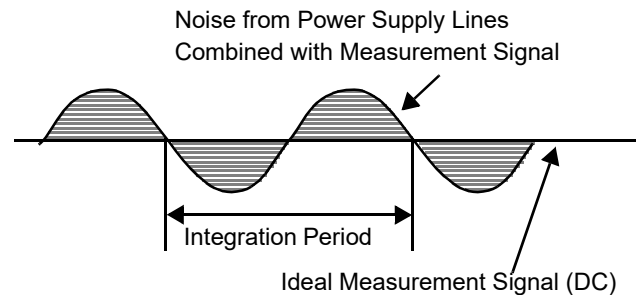

Figure 1. Effect of Noise from Power Supply Lines

For high-resistance measurements, connecting the shield to the GUARD potential is helpful.

For the lower resistance ranges, the measurement wires should be twisted together, apart from the GUARD-potential shield.

Even when the integration time is set by a PLC, measured values are unstable if the line frequency setting is 60 Hz and the instrument is used in a 50-Hz region. Confirm the line frequency setting of the instrument.

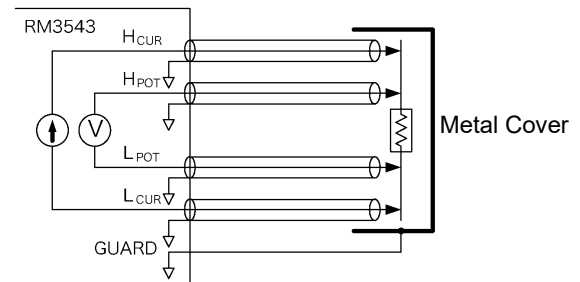

Figure 2. For High-Resistance Measurements

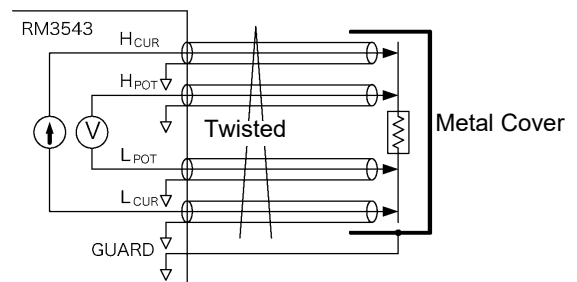

Figure 3. For Low-Resistance Measurements

Measurement should be conducted as far as possible from devices emitting electric or magnetic fields such as power cords, fluorescent lights, solenoid valves and PC displays. If electrical noise ingress is a problem, prepare the measurement leads as shown in Figs. 2 and 3.

If thermal emf is a problem, use the RM3543's OVC function. If OVC cannot be used for reasons such as tact time limitations, use a low-thermal emf material such as copper for wiring, and protect against airflow on connecting parts (test object or connectors).

### (2) Multi-Point Contacts with Clip Leads

The ideal conditions for four-terminal measurements are shown in Fig. 4: current flows from the far probe and voltage is detected with uniform current distribution.

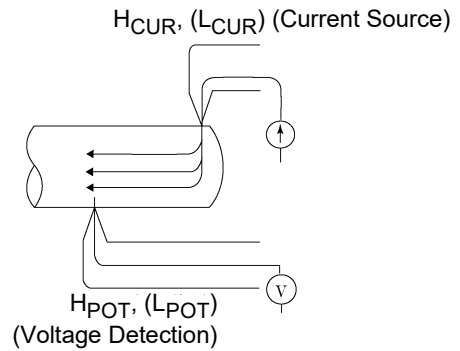

Figure 4. Ideal Four-Terminal Method

To facilitate measurement, the tips of the Model 9140 4-Terminal Probe are jagged.

When a clip is opened as shown in Fig. 5, measurement current flows from multiple points, and voltage is detected at multiple points. In such cases, the measurement value varies according to the total contact area.

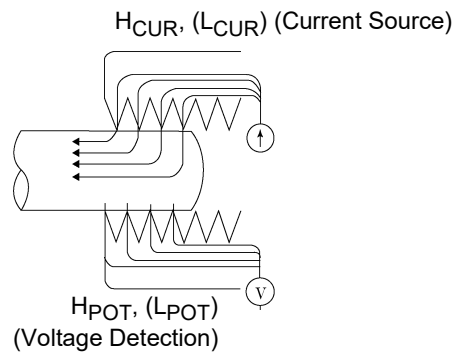

Figure 5. Measurement with Model 9140 4-Terminal Probe

Additionally, as shown in Fig. 6, when measuring the resistance of a 100 mm length of wire, the length between the nearest edges of the clips is 100mm, but the length between the farthest edges of the clips is 110mm, so the actual measurement length (and value) has an uncertainty of 10mm (10%). If measured values are unstable for any of these reasons, maximize stability by measuring with point contacts as far as possible.

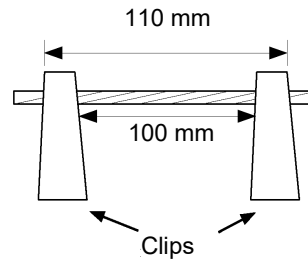

Figure 6. Measuring the resistance of a 100 mm length of wire

### (3) Wider/Thicker DUTs

If the DUT has a certain width or thickness like boards or blocks, it will be difficult to measure accurately using Pin Type Leads or Clip Type Leads. By using such measurement probes, there may be considerable fluctuation of the measured value due to contact pressure or contact angle. For example, when measuring a W300 x L370 x t0.4 mm metal board, the measured values are fairly different, even if measuring the same points, as shown below:

- 0.2mm pitch Pin type lead: 1.1 m $\Omega$
- 0.5mm pitch Pin type lead: 0.92 to 0.97 m $\Omega$
- Model 9287-10 Clip Type Lead: 0.85 to 0.95 m $\Omega$

This does not depend on the contact resistance between probes and the DUT, but on the current distribution on the DUT.

Fig. 7 is an example of plotting equivalent electric potential lines of a metal board. Similar to the relation between atmospheric pressure distribution and wind on a weather forecast diagram, current density is higher in locations where the equivalent electric potential lines are narrowly spaced, and lower in locations where they are widely spaced. Through this example, it is shown that the electric potential slope is larger around current applying points. This phenomenon is caused by high current density while current expands on the metal board. Due to this phenomenon, measured values should be rather different, even if the connected position difference is quite slight, in case connecting voltage detection terminals (of measurement probes) near current applying points.

It is known that such effects can be minimized by detecting the voltage within the space between the current contact points. Generally, if the distance between the voltage detection points and their corresponding current application points (CUR, POT terminals) is greater than the width (W) or thickness (t) of the DUT, current distribution may be considered uniform. As shown in Fig. 8, POT leads should be 3W or 3t mm or more inside from the CUR leads.

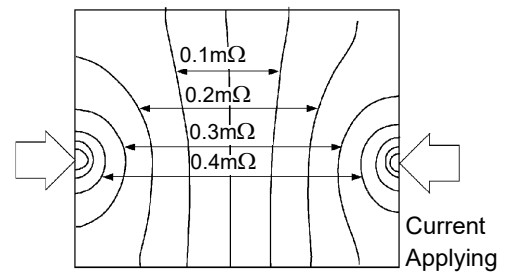

Figure 7. Equipotential lines on a metal board (W300 x L370 x t0.4 mm)

\* Applying 1 A current on points on edges and plotting equivalent electric potential lines at each 50 $\mu$ V level

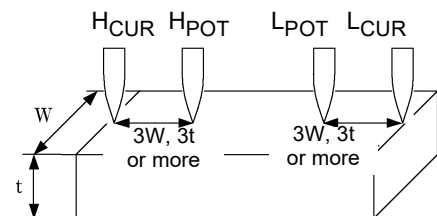

Figure 8. Probe Positions on Wider/Thicker DUT

### (4) Unstable Temperature of the DUT

Copper wire resistance has a temperature coefficient of about 0.4%/°C. Just holding a copper wire in the hand raises its temperature, causing its resistance to be increased as well. When the hand is removed from the wire, temperature and resistance decrease.

Varnished windings are more susceptible to temperature increase, so the resistance tends to be relatively high.

Use an instrument with a temperature-compensation function such as the Hioki RM3544, RM3545, and RM3548 to minimize copper-like temperature dependence.

# A6

## Appendix 3 Unstable Measurement Values

### (5) DUT Becomes Warm

The maximum applied power to a measurement object by this instrument is determined as follows. The resistance of samples with small thermal capacity can change due to heating.

Range	Measurement Current	Maximum Applied Power = (Measured Resistance) x (Measurement Current) <sup>2</sup>
10mΩ	1 A	12 mW
100mΩ	1 A	120 mW
100mΩ	100 mA	1.2 mW
1000mΩ	100 mA	12 mW
10Ω	10 mA	1.2 mW
100Ω	10 mA	12 mW
1000Ω	1 mA	1.2 mW

### (6) Ingress of External Noise

Measurement should be conducted as far as possible from devices emitting electric or magnetic fields such as power cords, fluorescent lights, solenoid valves and PC displays.

If external noise ingress is a problem, prepare the measurement leads as shown in Fig. 9.

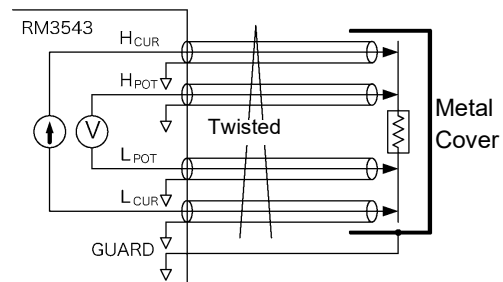

Figure 9. Wiring to Minimize Noise Ingress

### (7) Measuring Transformers and Motors

If noise enters an unconnected terminal of a transformer or if motor rotor moves, measurements may be unstable due to induced voltage on the measured winding. Pay attention to the treatment of unconnected terminals on transformers or to motor vibration.

### (8) Measuring Large Transformers or Motors

When measuring high-inductance (high-Q) DUTs such as large transformers or motors, measured values may be unstable.

The RM3543 depends on constant current flow through the DUT, but producing constant current becomes impossible as inductance approaches infinity. To obtain stability in a constant-current source with a large inductance, response time is sacrificed. If you find that resistance values are scattered when measuring large transformers or motors, please consider the above or contact your local HIOKI distributor for further assistance.



**(9) Non-Four-Terminal Measurements**

The four-terminal method requires that four probes be connected to the DUT.

By measuring as shown in Fig.10, the measured resistance includes that of the contacts between the probes and DUT. Typical contact resistance is several milliohm with gold plating, and several tens of milliohm with nickel plating. With measurement values of several  $k\Omega$  this would not seem to be a problem, but if a probe tip is oxidized or dirty, contact resistance on the order of a  $k\Omega$  is not unusual.

To maximize the opportunity for proper measurements, emulate the four-terminal method as close as possible to the contact points of the DUT. (Fig.11)

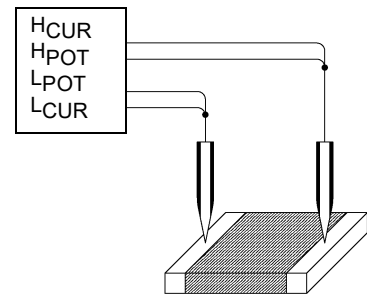

Figure. 10 Two-Terminal Measurement

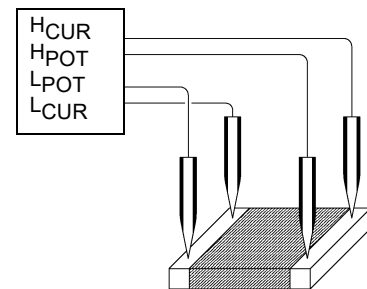

Figure. 11 Four-Terminal Measurement

### (10) Effects of cable configuration

To cancel thermal EMF, the RM3543 periodically reverses the polarity of the measurement current (via its OVC function). Additionally, it only applies the current during measurement to limit heat generation. Rapid fluctuations in this measurement current trigger corresponding fluctuations in the magnetic field, inducing the following voltage in the voltage detection line between H<sub>POT</sub> and L<sub>POT</sub>:

$$v = \frac{d\phi}{dt} = \frac{d}{dt} \left( \mu S \frac{I}{l} \right) = \frac{\mu S}{l} \cdot \frac{dI}{dt}$$

To avoid the effects of this voltage, the RM3543 waits for a fixed period of time after the measurement current changes before acquiring the voltage between H<sub>POT</sub> and L<sub>POT</sub>.

It is necessary to exercise caution when there are metallic objects present near the measurement cable or measurement target. When the measurement current fluctuates, an eddy current will be induced in such objects (see Figure 12). This induced current is characterized by a sawtooth-shaped waveform and affects the voltage detection line between H<sub>POT</sub> and L<sub>POT</sub> for an extended period of time (see Figure 13.b). The eddy current gradually decays due to the resistance of the metal plate, so its effect is more pronounced the faster the measurement speed.

The following five methods may be used to counteract this issue:

1. Move the metallic object father away.
2. Twist the H<sub>POT</sub> and L<sub>POT</sub> lines together.  
Doing so will make the lines more resistant to the effects of the eddy current.
3. Twist the H<sub>CUR</sub> and L<sub>CUR</sub> lines together.  
Doing so will inhibit the generation of an eddy current.
4. Increase the DELAY2 setting.  
Doing so will delay the start of measurement until the eddy current has dissipated.
5. Reduce the measurement speed.  
Averaging data from the start of measurement, when the effects of the eddy current are more pronounced, can effectively reduce those effects.

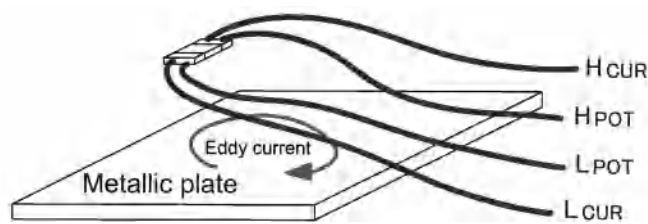

Figure. 12 Generation of an eddy current

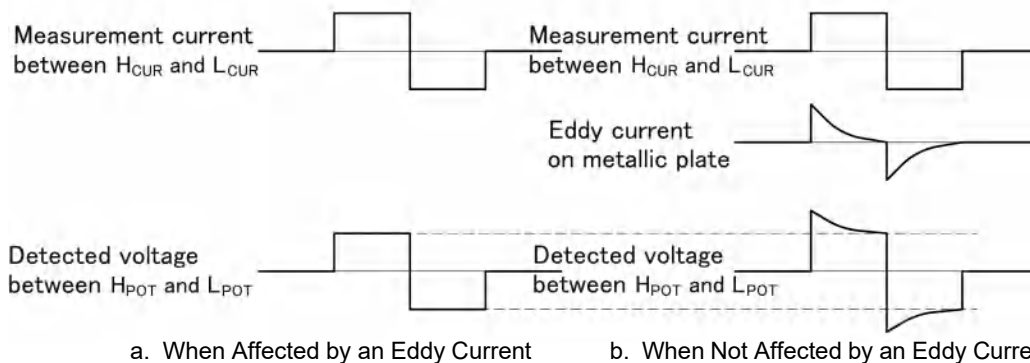

Figure. 13 Variations in the Detected Voltage Due to Eddy Currents

## Appendix 4 Effects of Probing

When mounting a two-terminal current sensing resistor on a printed circuit board, it is typical to separate the current line and voltage detection line as shown in Figure 1 in order to avoid the effects of wiring resistance. To ensure that the current will flow uniformly, it is necessary to use current lines that are the same width as the electrodes and to avoid bending the trace in the vicinity of the electrodes (see Figure 2).

Wire probes are typically used in testing current sensing resistors (see Figure 3). In this case, the measurement current gradually spreads out inside the current sensing resistor from the point of entry ( $H_{CUR}$ ) and then returns to the probe point ( $L_{CUR}$ ) (see Figure 4). If the voltage terminals ( $H_{POT}$ ,  $L_{POT}$ ) are placed near the current entry point ( $H_{CUR}$ ,  $L_{CUR}$ ), where the current density is high, the reading will tend to be greater than the resistance value in the mounted state (see Figure 5).

The RM3543's scaling function can be used to compensate for this effect. This function corrects the measured value  $R$  with the linear function  $AR+B$  based on the coefficient  $A$  and offset  $B$ . An example of how the constants  $A$  and  $B$  are calculated using scaling is described below.

### STEP 1

Prepare two resistors whose resistance values in the mounted state are known. The resistance values in the mounted state are given by  $R_{M1}$  and  $R_{M2}$ .

### STEP 2

Measures the two resistors with the RM3543's tester. The resistance values in the test state are given by  $R_{I1}$  and  $R_{I2}$ .

### STEP 3

The simultaneous equations are as follows:

$$\begin{cases} R_{M1} = AR_{I1} + B \\ R_{M2} = AR_{I2} + B \end{cases}$$

Solving for  $A$  and  $B$ ,

$$\begin{cases} A = \frac{R_{M2} - R_{M1}}{R_{I2} - R_{I1}} \\ B = \frac{R_{M1}R_{I2} - R_{M2}R_{I1}}{R_{I2} - R_{I1}} \end{cases}$$

If you wish to cancel out differences between individual RM3543 instruments, you can provide a standard resistor near full-scale for the range being used (calibration value  $R_{M1}$ , value before RM3543 scaling  $R_{I1}$ ) and use the following equations, since the RM3543's zero point is extremely stable:

$$\begin{cases} A = \frac{R_{M1}}{R_{I1}} \\ B = 0 \end{cases}$$

# A10

## Appendix 4 Effects of Probing

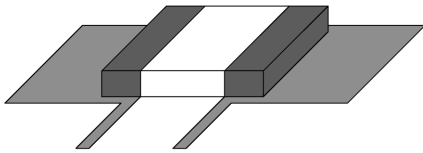

Figure. 1 A Current Sensing Resistor Mounted on a Printed Circuit Board

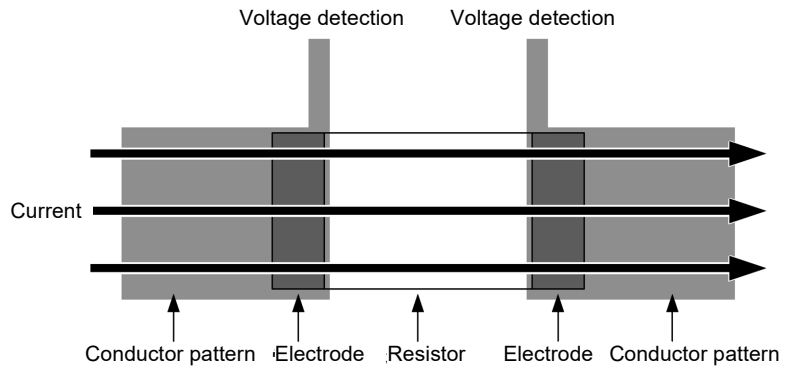

Figure. 2 Current Flow in the Mounted State

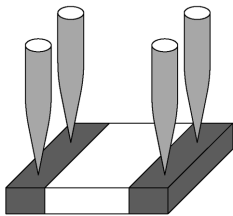

Figure. 3 Probing in the Test State

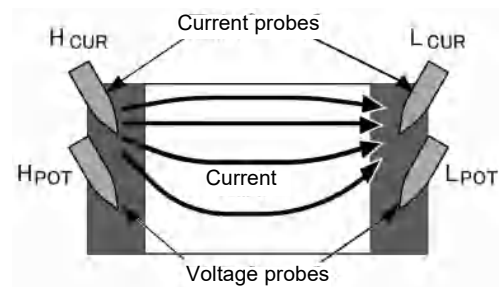

Figure. 4 Flow of Current in the Test State

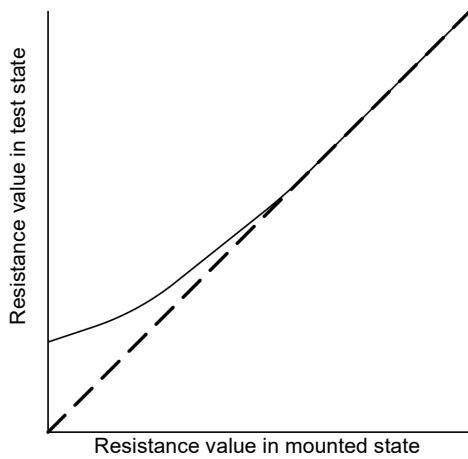

Figure. 5 Difference between Mounted State and Test State

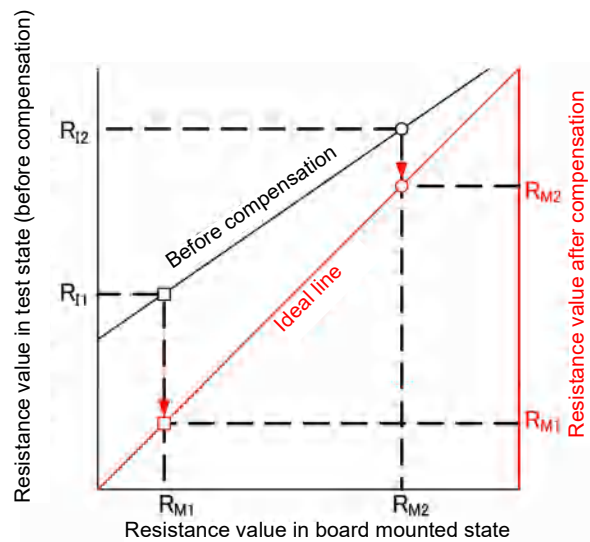

Figure. 6 Scaling Operation

# Appendix 5 Rack Mounting

By removing the screws on the sides, this instrument can be installed in a rack mounting plate.



Observe the following precautions regarding the mounting screws to avoid instrument damage and electric shock accidents.

- When installing the Rack Mounting Plate, the screws must not intrude more than 3.5 mm into either side of the instrument.
- When removing the Rack Mounting Plate to return the instrument to stand-alone use, replace the same screws that were installed originally. (Feet: M3 x 6 mm, Sides: M4 x 6 mm)

## Rack Mounting Plate Template Diagram and Installation Procedure

### Rack Mounting Plate (EIA)

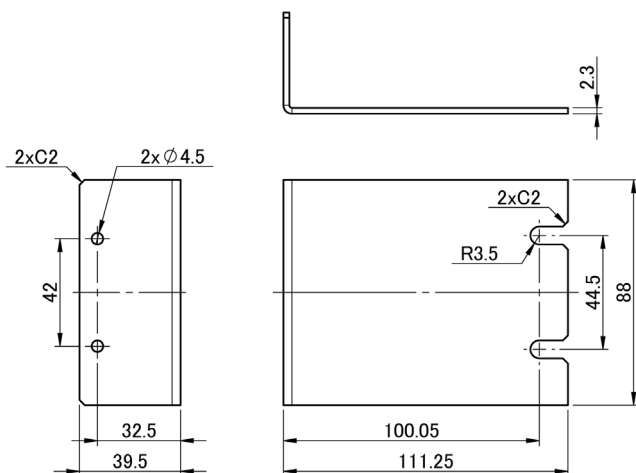

### Spacer (Two Required)

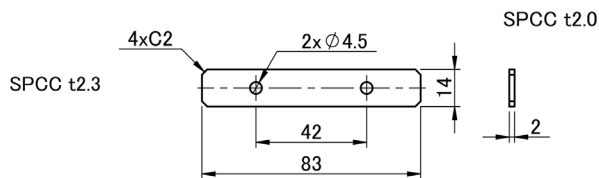

### Rack Mounting Plate (JIS)

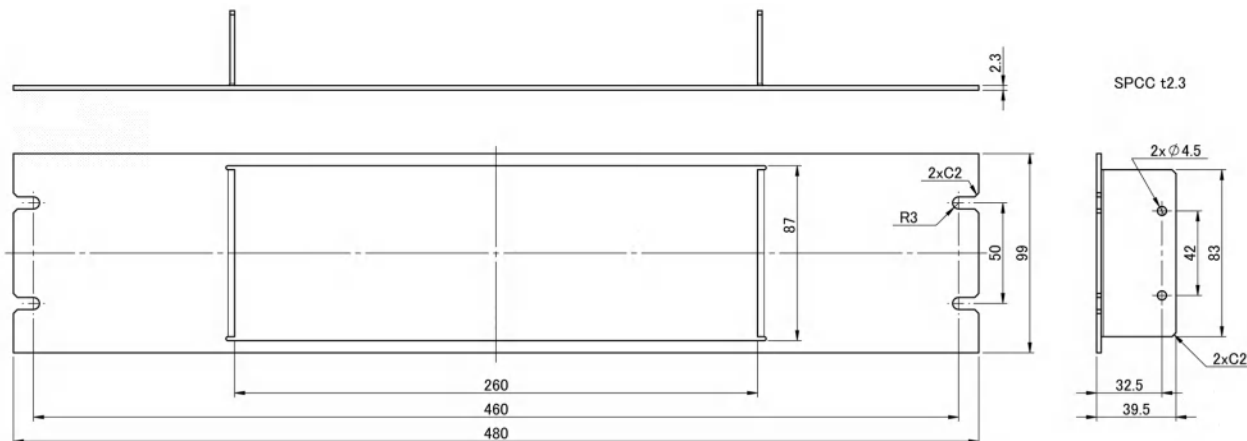

# A12

## Appendix 5 Rack Mounting

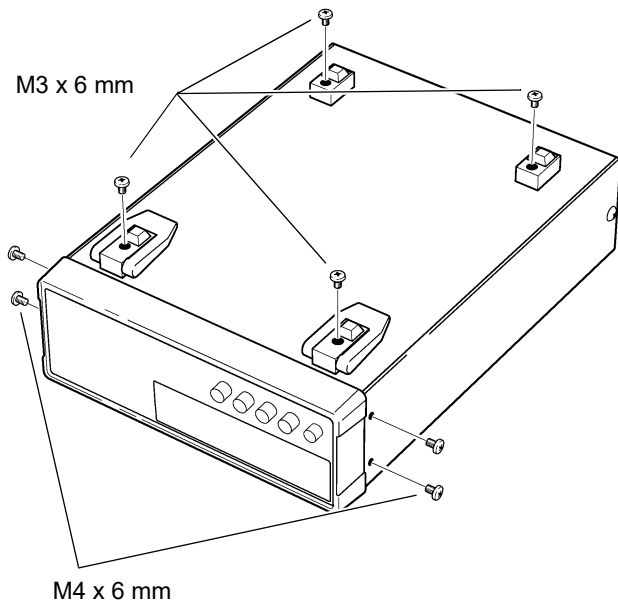

- 1 Remove the feed from the bottom of the instrument, and the screws from the sides (four near the front).

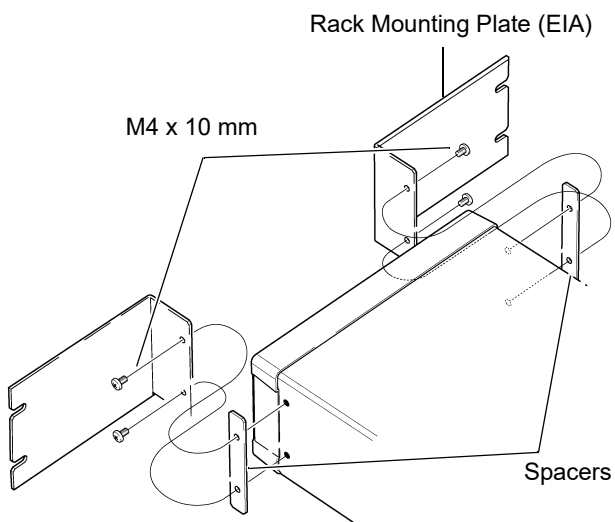

- 2 Installing the spacers on both sides of the instrument, affix the Rack Mounting Plate with the M4 x 10 mm screws.

**When installing into the rack, reinforce the installation with a commercially available support stand.**

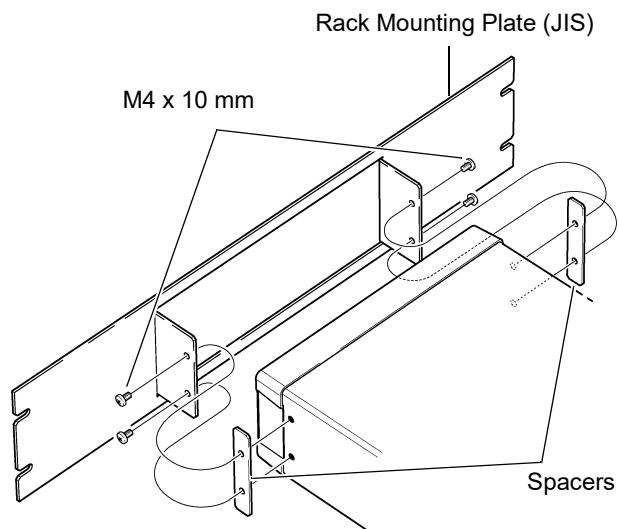

Appendix 6 Dimensional Diagram

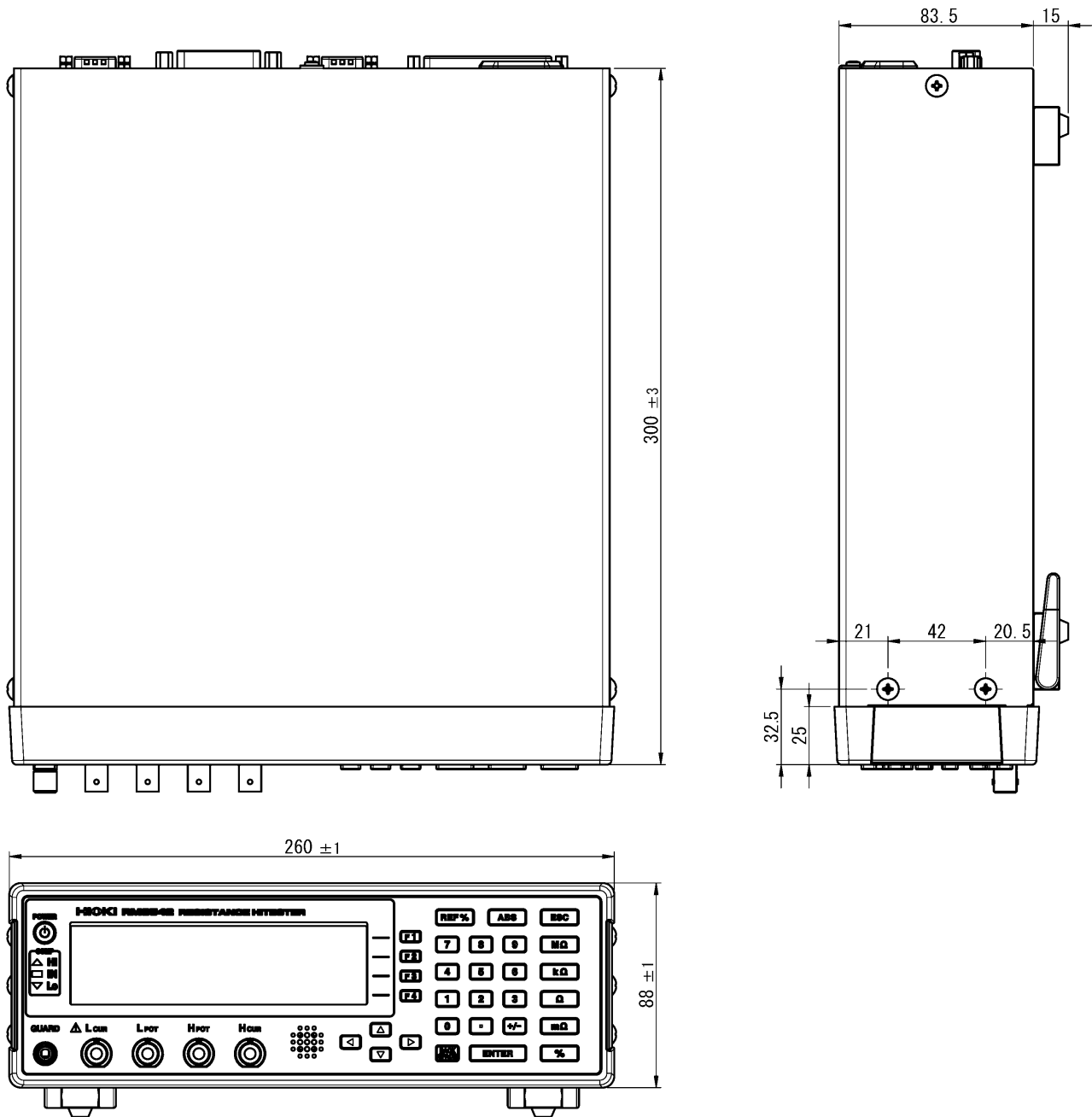

# Appendix 7 Calibration

### Calibration Conditions

- Ambient temperature and humidity 23±5°C, 80%RH or less
- Warm-up time 30 minutes
- Power supply 100 to 240 V±10%, 50/60 Hz
- Measurement speed SLOW
- Integration time Default setting
- Contact Improver OFF (Required when using the Fluke 5700A)
- Measurement Current CONT (Required when using the Fluke 5700A)
- Probe short-circuit detection OFF
- 0ADJ OFF (necessary)
- External magnetic field Environment close to the Earth's magnetic field
- Voltage level monitor OFF (Required when using the Fluke 5700A)

### Calibration equipment

Please use the following for calibration equipment.

See: " Connection Methods" (p. A15)

#### Resistance measurement equipment

- Fluke 5700A (10 Ω or more) or equivalent
- Alpha Electronics CSR-10 mΩ or equivalent
- Alpha Electronics CSR-100 mΩ or equivalent
- Alpha Electronics CSR-1 Ω or equivalent

If the Fluke 5700A cannot be used, please use the following equipment.

- Alpha Electronics CSR-100 (10 Ω)
- Alpha Electronics CSR-101 (100 Ω)
- Alpha Electronics CSR-102 (1 kΩ)

#### When using the YOKOGAWA 2792 to calibration

Use the Four-terminal Lead from Hioki. Note that connection cannot be made with the Clip Type Lead.

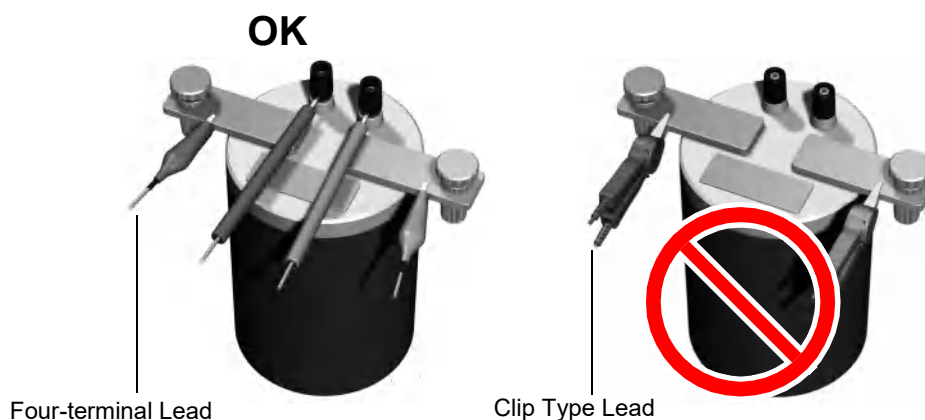

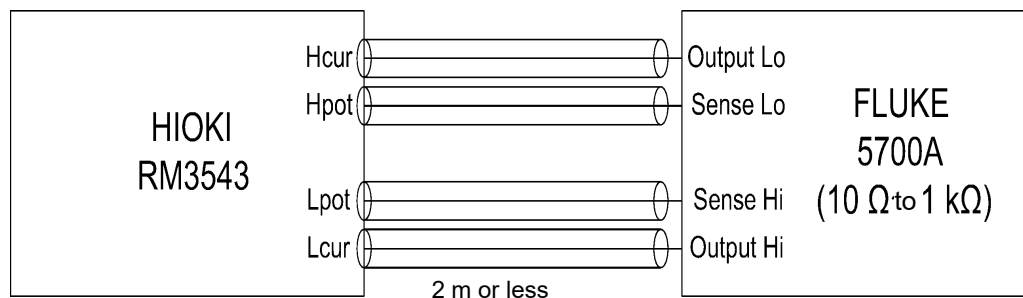
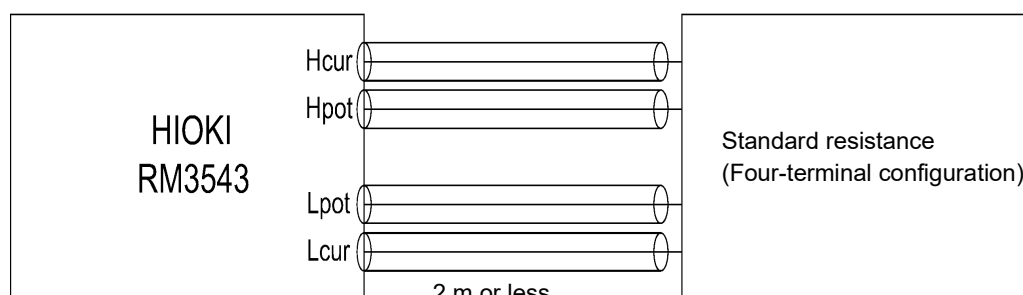

## Connection Methods

Calibration using Fluke 5700A at 10  $\Omega$  to 1 k $\Omega$ 

Calibration using standard resistance

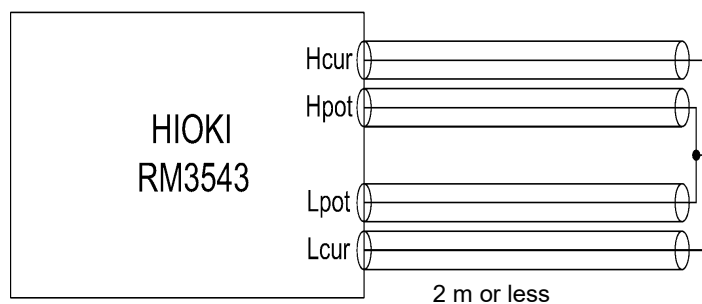
0- $\Omega$  calibration**NOTE**

- When calibrating using the Fluke 5700A, measured values may change during self-calibration (once every 10 minutes).
- During 0  $\Omega$  calibration, do not allow the measurement current to flow to the line connecting the H<sub>POT</sub> and L<sub>POT</sub> lines. For more information, see "Appendix 10 Zero Adjustment" (p. A19).

# A16

## Appendix 8 Adjustment Procedure

### Appendix 8 Adjustment Procedure

The System screen includes an adjustment screen.

The Adjustment screen is used in repairs and adjustment carried out by Hioki. It is not available for use by end-users.

---

SYSTEM			RETURN
LINE FREQ	AUTO	^	ADJUST
CONTRAST	50		
BACKLIGHT	80		
RESET			
ADJUST			

---

## Appendix 9 Table of Commands Compatible with the ADEX AX-1152D

Description	Model AX-1152D		Model RM3543	
	Command	Data	Command	Data
Measurement mode setting	<b>Ff</b>	f = D (% mode) / R (R mode)	<b>:CALCulate:LIMit:MODE m</b>	m = REF% (REF mode) / ABS (ABS mode)
Measurement range setting	<b>RNGr</b>	r = 0 to 6	<b>:RESistance:RANGe r</b>	r = 0 to 120E+6
Reference resistance setting	<b>SDdddd</b>	dddd = 500 to 10000	<b>:CALCulate:LIMit:REFERENCE float</b>	float = 0 to 120.000E+6
Setting % mode +/- tolerances	<b>DHsdddd</b> <b>DLsdddd</b>	s = +/- dddd = 0000 to 5000	<b>:CALCulate:LIMit:PERCent float1,float2</b>	float1 = -99.990 to 99.990 float2 = -99.990 to 99.990
Setting ABS mode thresholds	<b>LHdddd</b> <b>LLdddd</b>	dddd = 00000 to 15000	<b>:CALCulate:LIMit:ABS float1,float2</b>	float1 = 0 to 120.000E+6 float2 = 0 to 120.000E+6
Measurement speed setting	<b>Ww</b>	w = 0 (SLOW) / 1 (FAST)	<b>:SPEED s</b>	s = FAST/ Medium/ SLOW
Trigger	<b>E</b>		<b>*TRG</b>	

Note: The RM3543 cannot accept continuous commands (a delimiter is necessary between multiple commands).

# A18

## Appendix 9 Table of Commands Compatible with the ADEX AX-1152D

### Example 1

Measurement mode: R mode  
Measurement range: 100 mΩ  
Upper limit: 105.00 mΩ  
Lower limit: 95.00 mΩ  
Measurement speed: SLOW  
Trigger after the above settings

AX-1152D	RM3543
FR	:CALCulate:LIMit:MODE ABS
R2	:RESistance:RANGe 100E-3
LH10500	:CALCulate:LIMit:ABS 105E-3,95E-3
LL9500	
W0	:SPEEd SLOW
E	*TRG

or

FRR2LH10500LL9500W0E

Note: Although no delimiters are shown, they must be included at the end of each command line.

### Example 2

Measurement mode: % mode  
Measurement range: 10 mΩ  
Reference resistance: 10 mΩ  
Upper limit: 1.00%  
Lower limit: -1.00%  
Measurement speed: FAST  
Trigger after the above settings

AX-1152D	RM3543
M0	:CALCulate:LIMit:MODE REF
	:RESistance:RANGe 10E-3
RS100E+3	:CALCulate:LIMit:REFerence 10E-3
LH+1000E-2	:CALCulate:LIMit:PERCent 1,-1
LL-1000E-2	
S1	:SPEEd FAST
E	*TRG

or

FDR1SD10000DH+0100DL-0100W1E

Note: Although no delimiters are shown, they must be included at the end of each command line.

## Appendix 10 Zero Adjustment

Zero adjustment is a function which adjusts the zero point by deducting the residual value obtained during  $0\ \Omega$  measurement. For this reason, zero adjustment must be performed when connection is made to  $0\ \Omega$ . However, connecting a sample with no resistance is difficult and therefore is not practical.

In this respect, when performing the actual zero adjustment, create a pseudo connection to  $0\ \Omega$  and then adjust the zero point.

### To create $0\ \Omega$ connection state

If an ideal  $0\ \Omega$  connection is made, the voltage between  $H_{POT}$  and  $L_{POT}$  becomes  $0\ V$  according to the Ohm's Law of  $E = I \times R$ . In other words, if you set the voltage between  $H_{POT}$  and  $L_{POT}$  to  $0\ V$ , this gives you the same state of  $0\ \Omega$  connection.

### To perform zero adjustment using the instrument

The instrument uses a measurement fault detection function to monitor the state of connection between the four measurement terminals. For this reason, when performing zero adjustment, you need to make connections between the terminals appropriately in advance (Figure 1).

First, short between  $H_{POT}$  and  $L_{POT}$  to set the voltage between  $H_{POT}$  and  $L_{POT}$  to  $0\ V$ . If lead resistances  $R_{SEH}$  and  $R_{SEL}$  of the cable are less than few  $\Omega$ , there will be no problem. Because the POT terminal is a voltage measurement terminal, almost no current  $I_0$  flows. Therefore, in the  $E = I_0 \times (R_{SEH} + R_{SEL})$  formula,  $I_0 \approx 0$  is achieved; if lead resistances  $R_{SEH}$  and  $R_{SEL}$  are less than few  $\Omega$ , voltage between  $H_{POT}$  and  $L_{POT}$  will become almost zero.

Next, make connection between  $H_{CUR}$  and  $L_{CUR}$ . This is to avoid display of error when no measurement current flows through. Lead resistances  $R_{SOH}$  and  $R_{SOL}$  of the cable must be less than the resistance for flowing measurement current.

Furthermore, if you also monitor the connection between POT and CUR, you need to make connection between POT and CUR. If lead resistance  $R_{Short}$  of the cable has only few  $\Omega$ , there will be no problem.

If you wire in the way described above, measurement current  $I$  flowing out from  $H_{CUR}$  will go to  $L_{CUR}$  but not to the lead of  $H_{POT}$  or  $L_{POT}$ . This enables the voltage between  $H_{POT}$  and  $L_{POT}$  to be kept accurately at  $0\ V$ , and appropriate zero adjustment becomes possible.

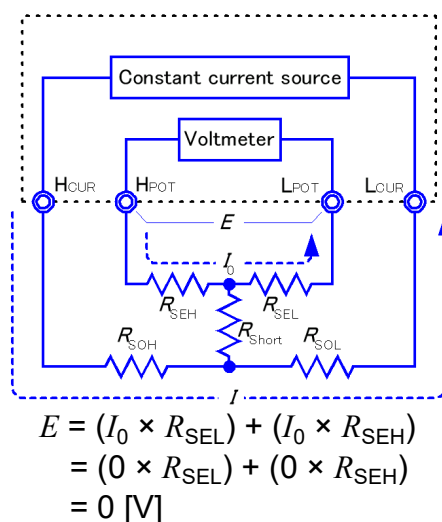

Figure 1. Pseudo connection to  $0\ \Omega$

### To perform zero adjustment appropriately

Table 1 shows the correct and wrong connections. The resistances in the figure indicate lead resistances; there will be no problem if they are less than few  $\Omega$  respectively

In (a), if you connect  $H_{POT}$  and  $L_{POT}$  as well as  $H_{CUR}$  and  $L_{CUR}$  respectively, and use one path to make connection between POT and CUR, no potential difference occurs between  $H_{POT}$  and  $L_{POT}$ , and 0 V is input. This enables zero adjustment to be carried out correctly.

In (b), on the other hand, if you connect  $H_{POT}$  and  $H_{CUR}$  as well as  $L_{POT}$  and  $L_{CUR}$  respectively, and use one path to make connection between Hi and Lo,  $I \times R_{Short}$  voltage occurs between  $H_{POT}$  and  $L_{POT}$ . For this reason, the pseudo 0  $\Omega$  connection state cannot be achieved and zero adjustment cannot be carried out correctly.

Table 1: Connection methods

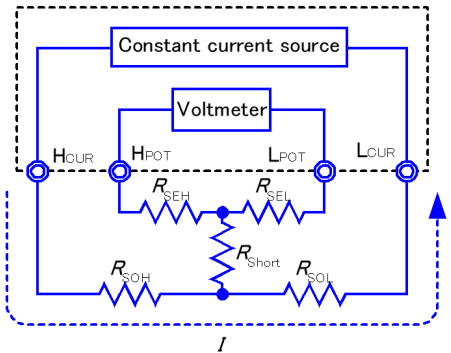
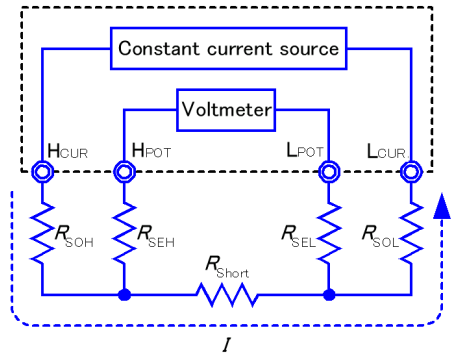
Connection methods	 <p>(a) Use one point each between POT and CUR for connection</p>	 <p>(b) Use one point each between Hi and Lo for connection</p>
Resistance between $H_{POT}$ and $L_{POT}$	$R_{SEH} + R_{SEL}$	$R_{SEH} + R_{Short} + R_{SEL}$
Measurement current $I$ 's flow path	$R_{SOH} \rightarrow R_{SOL}$	$R_{SOH} \rightarrow R_{Short} \rightarrow R_{SOL}$
Voltage occurring between $H_{POT}$ and $L_{POT}$	0	$I \times R_{Short}$
As connection method for zero adjustment	Correct	Wrong

### To perform zero adjustment using a probe

When you actually perform zero adjustment using a probe, you may unexpectedly make the connection shown in Table 1 (b). Therefore, when performing zero adjustment, you need to pay sufficient attention to the connection state of each terminal.

Here, 9287-10 Clip Type Lead is used as an example for the connection explanation. Table 2 shows the connection state of the tip of the lead and equivalent circuit in the respective correct and wrong connections. Table 1 (a) indicates the correct connection method, resulting in 0 V between  $H_{POT}$  and  $L_{POT}$ . However, Table 1 (b) is the wrong connection method, so that 0 V is not obtained between  $H_{POT}$  and  $L_{POT}$ .

Table 2: Clip type lead connection methods used during zero adjustment

	Correct	Wrong
Connection method		
Tip of lead		
Equivalent circuit		
Deformed equivalent circuit		
As connection method for zero adjustment	Correct	Wrong



### To perform zero adjustment using 9454 Zero Adjustment Board

When performing zero adjustment, you cannot use a metal board or similar object to replace 9454 Zero Adjustment Board.

9454 Zero Adjustment Board is not just a metal board. Its structure consists of two layers of metal boards screwed at one point. The zero adjustment board is used when performing zero adjustment of 9465 Pin Type Lead.

Table 3 shows cross sectional diagrams and equivalent circuits of the two connection methods: connecting Pin Type Lead to zero adjustment board, and connecting that to a metal board or similar object. Table 1 (a) indicates the connection using zero adjustment board, resulting in 0 V between  $H_{POT}$  and  $L_{POT}$ . However, Table 1 (b) is the connection using a metal board or similar object, so that 0 V is not obtained between  $H_{POT}$  and  $L_{POT}$ .

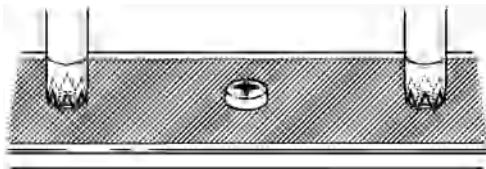
Table 3: Pin type lead connection methods in zero adjustment

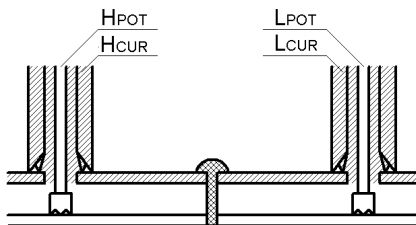
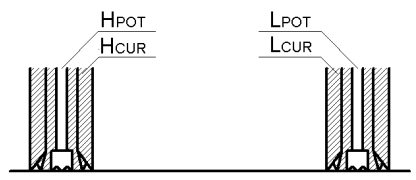
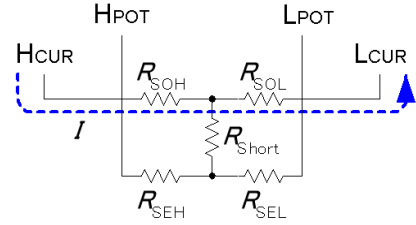
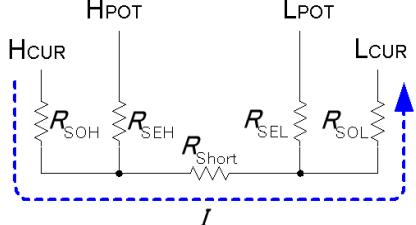
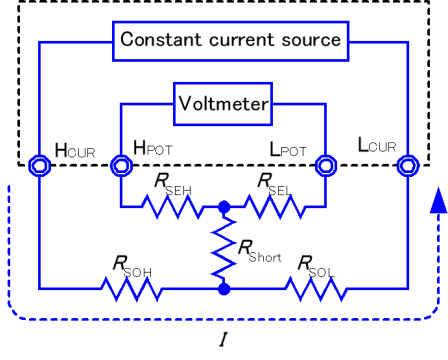
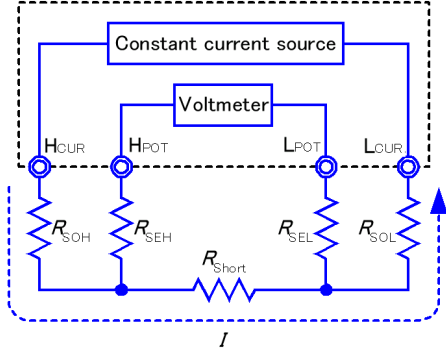
<p>Connection method</p>	 <p>If connection is made using 9454 Zero Adjustment Board</p>	 <p>If connection is made using metal board or similar object</p>
<p>Tip of lead</p>		
<p>Equivalent circuit</p>		
<p>Deformed equivalent circuit</p>		
<p>As connection method for zero adjustment</p>	<p>Correct</p>	<p>Wrong</p>



## If zero adjustment is difficult when using self-made probe to measure

When you perform zero adjustment using a self-made probe to do measurement, connect the tip of the self-made probe as shown in Table 1 (a). However, if such connection is difficult, you can try the following methods.

### If DC resistance meter is used

The main purpose of performing zero adjustment is to remove offset of the measurement instrument. For this reason, the value to be deducted as a result of zero adjustment almost does not depend on the probe. Therefore, after using a different probe to make the connection shown in Table 1 (a) and performing zero adjustment, you can replace it with a self-made probe to measure with offset removed from the measurement instrument.

### If AC resistance meter is used

In addition to removing offset of the measurement instrument, another main purpose of performing zero adjustment is to remove influence of the probe shape. For this reason, when performing zero adjustment, try as much as possible to set the form of the self-made probe close to the measurement state. Then, you need to make the connection as shown in Table 1 (a) and perform zero adjustment.

However, if a HIOKI product is used, even in AC resistance measurement, if the required resolution exceeds  $100 \mu\Omega$ , the same zero adjustment method used in DC resistance meter may be sufficient.

# A24

## *Appendix 10 Zero Adjustment*

---

---

# Index

## Symbols

+OvrRng ..... 185

## Number

0ADJ ..... 91

## A

ABS ..... 34

Accuracy ..... 180

Adjustment ..... A 16

ASCII ..... 107

Auto-Memory Function ..... 73, 75

Auto-Ranging ..... 31

Average ..... 78

Averaging Function ..... 48

## B

Backlight ..... 70

Backup function ..... 26

Basic Settings screen ..... 17, 18

Baud rate ..... 102

Binary ..... 107

Block diagram ..... 14

Broken measurement cables ..... 49

## C

C.E. Hi ..... 38, 49, 185

C.E. Lo ..... 38, 49, 185

C.E. Volt ..... 38, 52, 185

CAL ..... 91

Calibration ..... A 14

CE\_HI ..... 91

CE\_LO ..... 91

Clock ..... 68

Command error ..... 119

Command execution time ..... 119

Command Message ..... 109

Command Syntax ..... 109

Communications ..... 105

Comparator decision ..... 66

Comparator decision beeper ..... 66

Comparator Function ..... 34

Comparing the Measurement Settings ..... 56

## Contact

Poor or improper contact ..... 49

Contact Check Fault ..... 38

Contact Check Function ..... 49

Contact Improver Function ..... 50

Continuous measurement ..... 30, 142

Count ..... 77

Crossover wiring ..... 104

Current Mode Setting ..... 53

Current Monitor Fault ..... 38

Current Monitor Function ..... 39

## D

Data exporting methods ..... 152

Data formats ..... 111

Data Memory Function ..... 73, 74

Data Output Function ..... 73, 81

DATA SETTINGS ..... 17, 19

Data Settings screens ..... 17, 19

Default settings ..... 72

DELAY ..... 42

Delay ..... 42

Delay time ..... 42, 43

Device clear ..... 112

Dimensional diagram ..... A 13

Disposing ..... 187

## E

EOM ..... 91

ERR ..... 91, 185

Error displays ..... 185

Event registers ..... 115

Device-Specific Event Status Registers

(ESR0 and ESR1) ..... 116

Standard Event Status Register (SESR) ..... 115

Execution error ..... 119

EXT ..... 30

EXT I/O ..... 178

Connection examples ..... 96

Connector ..... 100

External control Q&A ..... 99

External triggering (EXT) ..... 30

## F

F.LOCK ..... 63

Faulty measurements ..... 38

# Index 2

## Index

---

---

Fixed-point data ..... 111  
Floating-point exponential representation data 111  
Four-Terminal ..... A 1  
Free-run ..... 30, 99, 142  
Frequency ..... 67  
FULL ..... 63

## G

---

GP-IB interface ..... 179

## H

---

Header ..... 109, 110  
Header omission ..... 112  
HI ..... 91  
HOLD ..... 91

## I

---

IEEE 488.2 ..... 111  
IN ..... 91  
INDEX ..... 91  
INFO ..... 186  
Initialization Items ..... 118  
Initializing ..... 71  
Input buffer ..... 112  
Inspection ..... 27, 183  
INT ..... 30  
Integer data ..... 111  
Integration Time ..... 46, 173  
Internal Circuitry ..... 94  
Internal triggering (INT) ..... 30

## K

---

Key Beeper ..... 65  
KEY\_LOCK ..... 91  
Key-Lock Cancel ..... 64  
Key-Lock Function ..... 63  
Keys do not work ..... 184

## L

---

LO ..... 91  
LOCAL ..... 108  
Local state ..... 108  
Long form ..... 109

## M

---

M.LOCK ..... 63  
Manual Range ..... 31  
MEAS SETTINGS ..... 17, 19  
Measure automatically ..... 30  
Measured values  
    Formats ..... 144

    Shifted ..... 184  
    Store as soon as measurement is stable ..... 75  
    Storing data ..... 74  
    Unstable ..... 184, A 3  
    Unstable and errors ..... 24  
Measurement Cables ..... 23  
    Extending Measurement Cables ..... 25  
Measurement faults ..... 38, 91, 99  
Measurement flow ..... 142  
Measurement object ..... 28  
Measurement ranges ..... 29, 31, 171  
Measurement screen ..... 17, 18  
Measurement settings ..... 27  
Measurement Settings screens ..... 17, 19  
Measurement speed ..... 29, 46  
Measurement time ..... 181  
Message terminators ..... 110

## N

---

Noise ..... 25  
NR1 ..... 111  
NR2 ..... 111  
NR3 ..... 111  
NRf ..... 111

## O

---

Offset Voltage Compensation (OVC) ..... 61  
Out-of-range ..... 38  
Out-of-Range Detection Function ..... 39  
Output queue ..... 112  
Output signals ..... 91  
OVC ..... 61  
-OvrRng ..... 185  
OvrRng ..... 34, 38

## P

---

Population standard deviation ..... 78  
POWER button ..... 26  
Power cord ..... 22  
PRB\_CHECK ..... 91  
PRB\_SHORT ..... 91  
PRINT ..... 86, 91  
Printer ..... 83, 179  
Printing ..... 83, 86  
Probe Short-Circuit Detection Function ..... 54  
Process capability index (bias) ..... 78  
Process capability index (dispersion) ..... 78  
Program Messages ..... 109

## Q

---

Query error ..... 101, 112, 115, 119  
Query Message ..... 109

---

**R**

Rack Mounting .....	A 11
Range .....	41
REF% .....	34
Remote .....	108
Repair .....	183
Response messages .....	109
RS-232C .....	179

**S**

Scaling Function .....	44
Screen contrast .....	69
Self calibration .....	60, 91
Self-test .....	26, 27
Separators .....	111
Service request .....	113
SET MONITOR .....	179
Settings Monitor Function .....	56
Short form .....	109
Short-circuited probes .....	54
Signal pinouts .....	90
Standard deviation of sample .....	78
Standard Event Status Register .....	115
STAT .....	79
Statistical calculation results .....	80
Printing .....	86
Statistical calculations .....	79
Status Byte Register .....	113
SYSTEM .....	17, 20
System reset .....	71
System screens .....	17, 20

**T**

Test fixtures .....	23
Thermal emf .....	61, A 2
Timing chart .....	92
Contact improvement current .....	50
DELAY1/ DELAY2 .....	42
EXT I/O .....	92
Probe short-circuit detection .....	54
TRG .....	79, 130
TRIG .....	91, 98
Trigger source .....	30, 142
Triggering .....	142

**U**

UNLOCK .....	63
--------------	----

**V**

Voltage Level Monitor Function .....	52
Voltage Monitor fault .....	38

**W**

Wiring .....	24
--------------	----

**Z**

Zero Adjustment .....	32, A 19
Zero Adjustment Faults .....	33



## Warranty Certificate

# HIOKI

Model	Serial number	Warranty period Three (3) years from date of purchase ( ___ / ___ )
-------	---------------	--

Customer name: \_\_\_\_\_

Customer address: \_\_\_\_\_

### Important

- Please retain this warranty certificate. Duplicates cannot be reissued.
- Complete the certificate with the model number, serial number, and date of purchase, along with your name and address. The personal information you provide on this form will only be used to provide repair service and information about Hioki products and services.

This document certifies that the product has been inspected and verified to conform to Hioki's standards.

Please contact the place of purchase in the event of a malfunction and provide this document, in which case Hioki will repair or replace the product subject to the warranty terms described below.

### Warranty terms

1. The product is guaranteed to operate properly during the warranty period (three [3] years from the date of purchase).  
If the date of purchase is unknown, the warranty period is defined as three (3) years from the date (month and year) of manufacture (as indicated by the first four digits of the serial number in YYMM format).
2. If the product came with an AC adapter, the adapter is warranted for one (1) year from the date of purchase.
3. The accuracy of measured values and other data generated by the product is guaranteed as described in the product specifications.
4. In the event that the product or AC adapter malfunctions during its respective warranty period due to a defect of workmanship or materials, Hioki will repair or replace the product or AC adapter free of charge.
5. The following malfunctions and issues are not covered by the warranty and as such are not subject to free repair or replacement:
  - 1. Malfunctions or damage of consumables, parts with a defined service life, etc.
  - 2. Malfunctions or damage of connectors, cables, etc.
  - 3. Malfunctions or damage caused by shipment, dropping, relocation, etc., after purchase of the product
  - 4. Malfunctions or damage caused by inappropriate handling that violates information found in the instruction manual or on precautionary labeling on the product itself
  - 5. Malfunctions or damage caused by a failure to perform maintenance or inspections as required by law or recommended in the instruction manual
  - 6. Malfunctions or damage caused by fire, storms or flooding, earthquakes, lightning, power anomalies (involving voltage, frequency, etc.), war or unrest, contamination with radiation, or other acts of God
  - 7. Damage that is limited to the product's appearance (cosmetic blemishes, deformation of enclosure shape, fading of color, etc.)
  - 8. Other malfunctions or damage for which Hioki is not responsible
6. The warranty will be considered invalidated in the following circumstances, in which case Hioki will be unable to perform service such as repair or calibration:
  - 1. If the product has been repaired or modified by a company, entity, or individual other than Hioki
  - 2. If the product has been embedded in another piece of equipment for use in a special application (aerospace, nuclear power, medical use, vehicle control, etc.) without Hioki's having received prior notice
7. If you experience a loss caused by use of the product and Hioki determines that it is responsible for the underlying issue, Hioki will provide compensation in an amount not to exceed the purchase price, with the following exceptions:
  - 1. Secondary damage arising from damage to a measured device or component that was caused by use of the product
  - 2. Damage arising from measurement results provided by the product
  - 3. Damage to a device other than the product that was sustained when connecting the device to the product (including via network connections)
8. Hioki reserves the right to decline to perform repair, calibration, or other service for products for which a certain amount of time has passed since their manufacture, products whose parts have been discontinued, and products that cannot be repaired due to unforeseen circumstances.

HIOKI E.E. CORPORATION

<http://www.hioki.com>

18-07 EN-3







# HIOKI

<http://www.hioki.com>



**All regional  
contact  
information**

**HEADQUARTERS**

81 Koizumi  
Ueda, Nagano 386-1192 Japan

**HIOKI EUROPE GmbH**

Rudolf-Diesel-Strasse 5  
65760 Eschborn, Germany  
[hioki@hioki.eu](mailto:hioki@hioki.eu)

1906 EN

Edited and published by HIOKI E.E. CORPORATION

Printed in Japan

- CE declarations of conformity can be downloaded from our website.
- Contents subject to change without notice.
- This document contains copyrighted content.
- It is prohibited to copy, reproduce, or modify the content of this document without permission.
- Company names, product names, etc. mentioned in this document are trademarks or registered trademarks of their respective companies.