

CT6862, CT6863 CT6862-10, CT6863-10 CT6862-05, CT6863-05

AC/DC CURRENT SENSOR

Instruction Manual

EN

Oct. 2018 Revised edition 8
Printed in Japan
CT6862A981-08 18-10H



HIOKI



Our regional
contact
information

<http://www.hioki.com>

HEADQUARTERS

81 Koizumi
Ueda, Nagano 386-1192 Japan

HIOKI EUROPE GmbH

Rudolf-Diesel-Strasse 5
65760 Eschborn, Germany
hioki@hioki.eu

1808EN

Edited and published by HIOKI E.E. CORPORATION

Printed in Japan

- CE declarations of conformity can be downloaded from our website.
- Contents subject to change without notice.
- This document contains copyrighted content.
- It is prohibited to copy, reproduce, or modify the content of this document without permission.
- Company names, product names, etc. mentioned in this document are trademarks or registered trademarks of their respective companies.

Warranty

Warranty malfunctions occurring under conditions of normal use in conformity with the Instruction Manual and Product Precautionary Markings will be repaired free of charge. This warranty is valid for a period of three (3) years from the date of purchase. Please contact the distributor from which you purchased the product for further information on warranty provisions.

Introduction

Thank you for purchasing the HIOKI Model CT6862, CT6863, CT6862-10, CT6863-10, CT6862-05 and CT6863-05 AC/DC Current Sensor. To obtain maximum performance from the device, please read this manual first, and keep it handy for future reference.

Usage with Other Hioki Products

This device is used in connection with a dedicated instrument (Hioki). See "Specifications" for details.

Inspection

When you receive the device, inspect it carefully to ensure that no damage occurred during shipping. In particular, check the accessories and cables. If damage is evident, or if it fails to operate according to the specifications, contact your dealer or Hioki representative.

Overview

The CT6862, CT6862-05 (up to 50 A) and CT6863, CT6863-05 (up to 200 A) are the feed-through current sensors designed to measure AC/DC current with high precision. Featuring good frequency characteristics (amplitude & phase) and good temperature characteristics (sensitivity & offset), the sensor is also suitable for high-precision power measurements. The Model CT6862-10 and CT6863-10 is a current sensor that supports even higher-accuracy power measurement when used in combination with the Model 3390-10 Power Analyzer.

Safety Information

This manual contains information and warnings essential for safe operation of the device and for maintaining it in safe operating condition. Before using it, be sure to carefully read the following safety precautions.

⚠ DANGER

This device is designed to comply with IEC 61010 Safety Standards, and has been thoroughly tested for safety prior to shipment. However, mishandling during use could result in injury or death, as well as damage to the device. However, using the device in a way not described in this manual may negate the provided safety features. Be certain that you understand the instructions and precautions in the manual before use. We disclaim any responsibility for accidents or injuries not resulting directly from device defects.

Safety Symbol

	In the manual, the symbol indicates particularly important information that the user should read before using the device. The symbol printed on the device indicates that the user should refer to a corresponding topic in the manual (marked with the symbol) before using the relevant function.
	Indicates a double-insulated device.

The following symbols in this manual indicate the relative importance of cautions and warnings.

	Indicates that incorrect operation presents an extreme hazard that could result in serious injury or death to the user.
	Indicates that incorrect operation presents a significant hazard that could result in serious injury or death to the user.
	Indicates that incorrect operation presents a possibility of injury to the user or damage to the device.
	Indicates advisory items related to performance or correct operation of the device.

Symbols for Various Standards

	Indicates the Waste Electrical and Electronic Equipment Directive (WEEE Directive) in EU member states.
	This symbol indicates that the product conforms to regulations set out by the EC Directive.

Other Symbol

	Indicates a prohibited action.
--	--------------------------------

Measurement categories

This device complies with CAT III safety requirements. To ensure safe operation of measurement devices, IEC 61010 establishes safety standards for various electrical environments, categorized as CAT II to CAT IV, and called measurement categories.

CAT II: Primary electrical circuits in equipment connected to an AC electrical outlet by a power cord (portable tools, household appliances, etc.)
CAT II covers directly measuring electrical outlet receptacles.

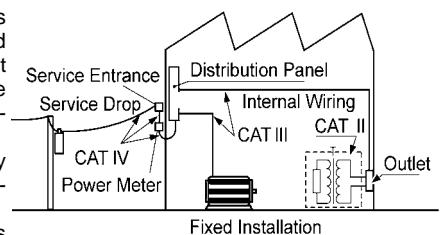

CAT III: Primary electrical circuits of heavy equipment (fixed installations) connected directly to the distribution panel, and feeders from the distribution panel to outlets.

CAT IV: The circuit from the service drop to the service entrance, and to the power meter and primary overcurrent protection device (distribution panel).

Using a measurement device in an environment designated with a higher-numbered category than that for which the device is rated could result in a severe accident, and must be carefully avoided.

Use of a measurement instrument that is not CAT-rated in CAT II to CAT IV measurement applications could result in a severe accident, and must be carefully avoided.

Noise	5 mVpp or less (100 kHz or less)														
Temperature coefficient	-30°C to 0°C and 40°C to 85°C Amplitude sensitivity : ±0.005%rdg./°C or less Offset voltage : ±0.005%.s./°C or less														
Effect of conductor position	±0.01%rdg. or less (CT6862: at 50 A input, DC to 100 Hz, using with the wire 5 mm diameter) (CT6863: at 100 A input, DC to 100 Hz, using with the wire 10 mm diameter)														
Effect of external electromagnetic field	CT6862: 10 mA or less, CT6863: 50 mA or less (Scaled value, in a DC or 60 Hz magnetic field of 400 A/m)														
Effect of magnetic	CT6862: 5 mA or less (Scaled value, after 50 A DC input) CT6863: 10 mA or less (Scaled value, after 200 A DC input)														
Effect of common-mode voltage	0.05%.s. or less (1000 V rms, DC to 100 Hz)														
Effect of radiated radio-frequency electromagnetic field	0.5%.s. at 10 V/m														
Effect of conducted radio-frequency electromagnetic field	0.5%.s. at 3 V														
Measurable conductor diameter	φ24 mm (0.94") or less														
Supply voltage	±11 V to ±15 V (Tracking)														
Power supply capacity	±200 mA or less (CT6862: 50 A/ 55 Hz measurement, with ±12 power supply) (CT6863: 200 A/ 55 Hz measurement, with ±12 power supply)														
Rated power	CT6862: 5 VA or less (50 A/55 Hz measurement, with ±12 power supply) CT6863: 6 VA or less (200 A/55 Hz measurement, with ±12 power supply)														
Dimensions	Approx. 70W × 100H × 53D mm (excluding protrusions, cable) (Approx. 2.76"W × 3.94"H × 2.09"D)														
Mass	CT6862: Approx. 340 g (12.0 oz.) CT6863: Approx. 350 g (12.3 oz.)														
Cable length	Approx. 3 m														
Output connector	CT6862(-10)/CT6863(-10) : Hioki PL23 (male) CT6862-05/CT6863-05 : Hioki ME15W (male)														
Accessories	Instruction manual, Mark band 6 (3sets)														
Options	<table border="1"> <tr> <td rowspan="4">CT6862,CT6862-10/ CT6863,CT6863-10</td> <td>CT9900</td> <td>Conversion Cable</td> </tr> <tr> <td>CT9903</td> <td>Extension Cable</td> </tr> <tr> <td>9318</td> <td>Conversion Cable</td> </tr> <tr> <td>9705</td> <td>Conversion Cable</td> </tr> <tr> <td rowspan="2">CT6862-05/ CT6863-05</td> <td>CT9901</td> <td>Conversion Cable</td> </tr> <tr> <td>CT9902</td> <td>Extension Cable</td> </tr> </table>	CT6862,CT6862-10/ CT6863,CT6863-10	CT9900	Conversion Cable	CT9903	Extension Cable	9318	Conversion Cable	9705	Conversion Cable	CT6862-05/ CT6863-05	CT9901	Conversion Cable	CT9902	Extension Cable
CT6862,CT6862-10/ CT6863,CT6863-10	CT9900		Conversion Cable												
	CT9903		Extension Cable												
	9318		Conversion Cable												
	9705	Conversion Cable													
CT6862-05/ CT6863-05	CT9901	Conversion Cable													
	CT9902	Extension Cable													

Combined accuracy and conditions

Combined accuracy = Accuracy of CT6862(-05) or CT6863(-05) + Accuracy of combined product (Power factor: 1)

Combined product	Required option	
	CT6862/CT6862-10 CT6863/CT6863-10	CT6862-05 CT6863-05
CT9555,CT9556,CT9557 Sensor Unit ^{*1}	CT9900	—
PW3390 Power Analyzer	CT9900	—
PW6001 Power Analyzer	CT9900	—
9602 AC/DC Clamp Input Unit ^{*2}	—	CT9901
3334-10 AC/DC Power HiTester	—	CT9901
8940 F/V Unit ^{*3*4}	9705 + 9318	CT9901 + 9705 + 9318
8971 Current Unit ^{*3}	9318	CT9901 + 9318
9555-10 Sensor Unit	—	CT9901
3390,3390-10 Power Analyzer	—	CT9901

*1: Add the sensor unit output accuracy to the combined accuracy when one of the addition functions, that is, RMS output or TOTAL OUTPUT, is used.

*2: Add ± 0.1% rdg. to the combined accuracy.

*3: The sensor recognition methods vary according to the Memory HiCorder settings (refer to the manuals of Memory HiCorder to be connected).

*4: CT6862, CT6862-10, and CT6862-05 cannot be used.

Derating

CT6862: Frequency

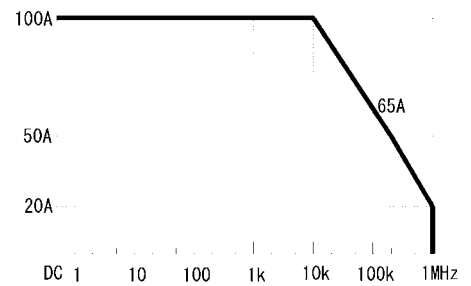

CT6862: Temperature

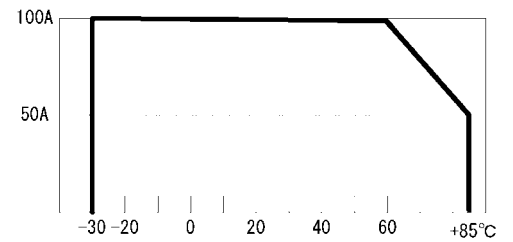

CT6863: Frequency

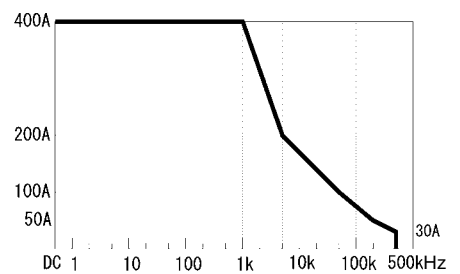

CT6863: Temperature

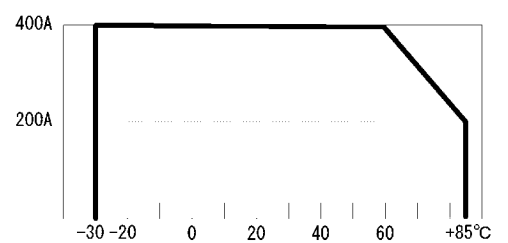

Names of Parts

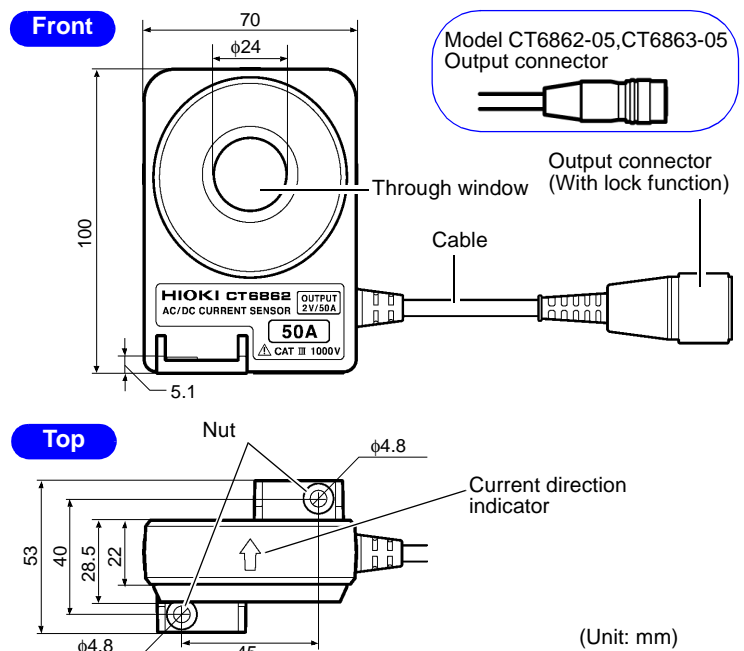







(Unit: mm)

Instrument Installation

Operating temperature and humidity : -30 to 85°C, 80%RH or less (non-condensation)

Avoid the following locations that could cause an accident or damage to the instrument.

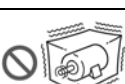
 Exposed to direct sunlight Exposed to high temperature	 In the presence of corrosive or explosive gases
 Exposed to water, oil, other chemicals, or solvents Exposed to high humidity or condensation	 Exposed to strong electromagnetic fields Near electromagnetic radiators
 Exposed to high levels of particulate dust	 Near induction heating systems (e.g., high-frequency induction heating systems and IH cooking utensils)
 Subject to vibration	

Usage Notes



Follow these precautions to ensure safe operation and to obtain the full benefits of the various functions.

Preliminary Checks

Before using the device the first time, verify that it operates normally to ensure that no damage occurred during storage or shipping. If you find any damage, contact your dealer or Hioki representative.

⚠ DANGER

- This device should only be connected to the secondary side of a breaker, so the breaker can prevent an accident if a short circuit occurs. Connections should never be made to the primary side of a breaker, because unrestricted current flow could cause a serious accident if a short circuit occurs.
- The maximum rated voltage between input terminals and ground is 1000 V DC/AC. Attempting to measure voltages exceeding 1000 V with respect to ground could damage the device and result in personal injury.

⚠ WARNING

- Before using the device, make sure that the insulation on the cable is undamaged and that no bare conductors are improperly exposed. Using the device in such conditions could cause an electric shock, so contact your dealer or Hioki representative for repair.
- In order to prevent electric shock and short-circuit accidents, shut off the power to the line to be measured before connecting this device.
- Ensure that the input does not exceed the maximum input voltage or current to avoid device damage, short-circuiting and electric shock resulting from heat building.
- Avoid contact between the cable and the measured line in order to protect the cable from damage. Any contact can cause the device to malfunction and lead to short-circuits or electric shock.

⚠ CAUTION

- This device is not drip-proof. Water droplets on the connector may result in malfunctions.
- Do not slant the device or place it on top of an uneven surface. Dropping or knocking down the device can cause injury or damage to the device.
- Avoid stepping on or pinching cables, which could damage the cable insulation.
- Keep the cables well away from heat sources, as bare conductors could be exposed if the insulation melts.
- To avoid damage to the device, protect it from physical shock when transporting and handling. Be especially careful to avoid physical shock from dropping.
- The cable is hardened under the 0 degree or colder environment. Do not bend or pull it to avoid tearing its shield or cutting cable.

⚠ CAUTION

- When the power to lines to be measured is turned on or off, a current flowing through the lines can exceed considerably the maximum allowable current of the device. This could result in damage to the device. Make sure that there is not any over-current.
- Do not apply any current through the lines to be measured with the device turned off. This could result in damage to the device.

Specifications

Accuracy

f.s.: maximum display value or scale length (Rated current)

rdg.: reading value (The value currently being measured and indicated on the measuring instrument)

About the CT6862-10 and CT6863-10

The CT6862-10 and CT6863-10 specifications are the same as the following CT6862 and CT6863 specifications, respectively.

For more information about specifications when used with the 3390-10, see the 3390-10 instruction manual.

The specs of the CT6862-05 are the same as those of the CT6862 except the output connector and options. CT6863 and CT6863-05 are similar.

Operating Environment	Indoors, Pollution degree 2, altitude up to 2000 m (6562-ft.)
Operating temperature and humidity	-30°C to 85°C (-22°F to 185°F), 80%RH or less (non-condensation)
Storage temperature and humidity	-30°C to 85°C (-22°F to 185°F), 80%RH or less (non-condensation)
Maximum rated voltage to earth	1000 V AC/DC (50 Hz/60 Hz), Measurement category III, Anticipated transient overvoltage 8,000 V
Applicable standards	Safety : EN61010 EMC : EN61326
Product warranty period	3 years
Rated current	CT6862: 50 A AC/DC, CT6863: 200 A AC/DC
Output voltage	CT6862: 2 V/ 50 A, CT6863: 2 V/ 200 A
Maximum input current	Within a derating
Output resistance	50 Ω (±5%)
Temperature and humidity range of guaranteed accuracy	0°C to 40°C (32 to 104°F), 80%RH or less
Period of guaranteed accuracy	1 year
Guaranteed accuracy period from adjustment made by Hioki	1 year

Accuracy

Sine wave input, conductor in center position, using with Model 9555-10, Measuring instrument having 1 MΩ or higher input resistance

Amplitude accuracy (Defined at the rated value or less and within the derating curve; The accuracy defined for the frequency range of DC < f < 5 Hz is the design value)

Phase accuracy (Defined at the rated value or less and within the derating curve; The accuracy defined for the frequency range of DC < f < 10 Hz is the design value)

CT6862

Frequency	Amplitude	Phase
DC	±0.05%rdg.±0.01%f.s.	—
DC < f ≤ 16 Hz	±0.10%rdg.±0.02%f.s.	±0.3°
16 Hz < f ≤ 400 Hz	±0.05%rdg.±0.01%f.s.	±0.2°
400 Hz < f ≤ 1 kHz	±0.2%rdg.±0.02%f.s.	±0.5°
1 kHz < f ≤ 5 kHz	±0.7%rdg.±0.02%f.s.	±1.0°
5 kHz < f ≤ 10 kHz	±1%rdg.±0.02%f.s.	±1.0°
10 kHz < f ≤ 50 kHz	±1%rdg.±0.02%f.s.	± (0.5+0.1 × f kHz) °
50 kHz < f ≤ 100 kHz	±2%rdg.±0.05%f.s.	
100 kHz < f ≤ 300 kHz	±5%rdg.±0.05%f.s.	
300 kHz < f ≤ 700 kHz	±10%rdg.±0.05%f.s.	
700 kHz < f < 1 MHz	±30%rdg.±0.05%f.s.	—

CT6863

Frequency	Amplitude	Phase
DC	±0.05%rdg.±0.01%f.s.	—
DC < f ≤ 16 Hz	±0.10%rdg.±0.02%f.s.	±0.3°
16 Hz < f ≤ 400 Hz	±0.05%rdg.±0.01%f.s.	±0.2°
400 Hz < f ≤ 1 kHz	±0.2%rdg.±0.02%f.s.	±0.5°
1 kHz < f ≤ 5 kHz	±0.7%rdg.±0.02%f.s.	±1.0°
5 kHz < f ≤ 10 kHz	±1%rdg.±0.02%f.s.	±1.0°
10 kHz < f ≤ 50 kHz	±2%rdg.±0.02%f.s.	± (0.5+0.1 × f kHz) °
50 kHz < f ≤ 100 kHz	±5%rdg.±0.05%f.s.	
100 kHz < f ≤ 300 kHz	±10%rdg.±0.05%f.s.	
300 kHz < f ≤ 500 kHz	±30%rdg.±0.05%f.s.	

Measurement Procedure

⚠️ WARNING

In order to prevent electric shock and short-circuit accidents, shut off the power to the line to be measured before connecting this device.

⚠️ CAUTION

- To prevent damage to the sensor and connected instrument, never connect or disconnect a sensor while the power is on.
- When the connected instrument's power is turned off, do not apply current to the sensor. Doing so may damage the device.
- When disconnecting the output connector, be sure to release the lock before pulling off the connector. Forcibly pulling the connector without releasing the lock, or pulling on the cable, can damage the connector.

NOTE

The sensor's signal output circuit is protected by a resistor (output resistor). A digital multimeter used for monitoring should have high input resistance (recommended minimum: 1 MΩ).

Wiring

Make sure the direction of the arrow on the case matches the direction of the current flow, as shown in Figure 1. If they are oriented incorrectly, the output signal from the sensor will be reversed.

Figure 1. Wiring example

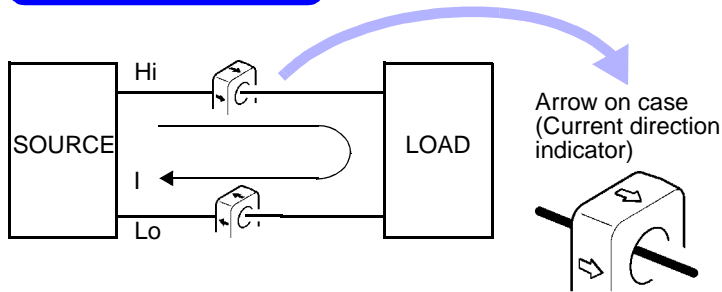

When the device is used with a wattmeter, follow the wiring instructions provided with the wattmeter.

NOTE

- Make sure to pass only one conductor through. Single-phase (2-wire) or three-phase (3-wire) cables conducted together will not produce any reading.

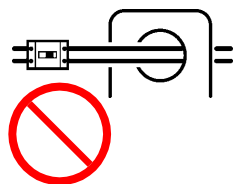
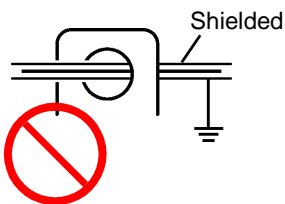
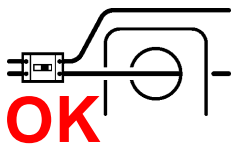

- Ground-shielded conductors cannot be accurately measured.

Maintenance Service

⚠️ WARNING

Do not attempt to modify, disassemble or repair the device; as fire, electric shock and injury could result.

- To clean the device, wipe it gently with a soft cloth moistened with water or mild detergent. Never use solvents such as benzene, alcohol, acetone, ether, ketones, thinners or gasoline, as they can deform and discolor the case.
- If the device seems to be malfunctioning, contact your dealer or Hioki representative. When returning the device for repair, pack the device so that it will not sustain damage during shipping, and include a description of existing damage. We cannot accept responsibility for damage incurred during shipping.

Options

9705 Conversion Cable^{*1}, 9318 Conversion Cable^{*1}, CT9900 Conversion Cable^{*1}, CT9901 Conversion Cable^{*2}

The Conversion Cable makes it possible to connect to and use with products that cannot be directly connected to the device. (Refer to "Connection example") (No figures are added to the accuracy.)

CT9902 Extension Cable^{*2}(5 m), CT9903 Extension Cable^{*1}(5 m)

- Single sensor cable, 5 m extension (max. 10 m extension)
- Up to two of the Extension Cable available (If three or more extension cables are connected to the device, its performance is not guaranteed)
- Add the following values to each of the accuracy per cable
Amplitude accuracy: $\pm 0.1\%$ rdg. ($DC \leq f^{*3} \leq 1 \text{ kHz}$)
: $\pm 0.5\%$ rdg. ($1 \text{ kHz} < f^{*3}$)
Phase accuracy : $\pm(0.1 \times f^{*3} \text{ kHz})^\circ$ ($1 \text{ kHz} < f^{*3}$)

*1: For CT6862(-10)/CT6863(-10) *2: For CT6862-05/CT6863-05

*3: frequency

Connection example

CT6862, CT6862-10
CT6863, CT6863-10

Attached Device

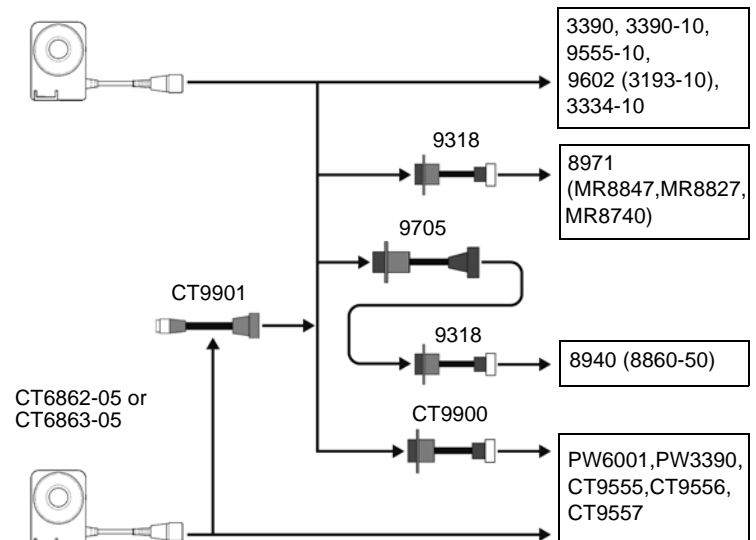

NOTE

Also refer to the Instruction manual for attached device.