

FT3470-51

HIOKI

FT3470-52

Instruction Manual

MAGNETIC FIELD HiTESTER



! Be sure to read this manual before using the instrument

Safety Information ▶ p.4

✓ When using the instrument for the first time

Names and Functions of Parts ▶ p.17

Measurement Preparations ▶ p.31

Measurement Procedure ▶ p.37

📖 Troubleshooting

Troubleshooting ▶ p.111

Error Indication ▶ p.112

EN

July 2018 Revised edition 1
FT3470F981-01 18-07H



Contents

Introduction	1
Inspection	2
Safety Information	4
Operating Precautions	7
1 Overview	9
1.1 Product Overview	9
1.2 Features	11
1.3 Measurement Example	13
1.4 Names and Functions of Parts	17
1.4.1 FT3470-50 Magnetic Field Tester	17
1.4.2 100 cm ² Magnetic Field Sensor	21
1.4.3 3 cm ² Magnetic Field Sensor	22
1.5 Definition of Measurement Items	23
1.6 Screen Configuration and Key Operation Work Flow	24
1.7 Measurement Work Flow	27
2 Measurement Preparations	31
2.1 Supplying Power	31
2.1.1 Connecting the AC Adapter	31
2.1.2 Inserting and Replacing Batteries	32
2.2 Connecting a Magnetic Field Sensor	34
2.3 Turning the Power On and Off	35
3 Measurement Procedure	37
3.1 Measurement Preparations	37
3.2 Pre-measurement Check	39
3.3 Measuring Magnetic Flux Density	40

3.4	Measuring Exposure Level (General Public)	43
3.4.1	Preparing for Exposure Measurements	43
3.4.2	Exposure Level	45
3.4.3	Measurement Procedure	47
3.5	Measuring Exposure Level (Occup.)	50
3.6	Holding Maximum Value of the Resultant RMS Values	53
3.7	Checking and Deleting Saved Measurement Data	54
3.7.1	Checking Saved Measurement Data	54
3.7.2	Deleting Saved Measurement Data	56
3.7.3	Deleting All Saved Measurement Data	58
4	Advanced Functions	59
<hr/>		
4.1	Function for Saving Settings (Saving Set Modes and Measurement Ranges)	59
4.2	Initializing Function (Returning Settings to Their Factory Defaults)	60
4.3	Other Functions	61
4.3.1	Setting Auto Power Off (Saving Battery Power)	61
4.3.2	Setting Audible Key Feedback	63
4.3.3	Changing Unit Indication	65
4.3.4	Setting the Slow Function	67
4.3.5	Enable/disable the MEM. MODE key when Using MAX. HOLD or the Output Function	69
5	Using Application Software	71
<hr/>		
5.1	Overview	71
5.2	Installing	72
5.2.1	Installing the Driver	72
5.2.2	Installing Software	82
5.3	Graphic Representation of Measurement Values	85
5.4	Transferring Recorded Data to a PC	88

5.5	Configuring the FT3470-50	91
5.6	Viewing Version Information	93
6	Advanced Measurements	95
<hr/>		
6.1	Outputting Waveform and Resultant RMS Values	95
7	Specifications	101
<hr/>		
7.1	FT3470-50 Magnetic Field Tester	101
7.1.1	Basic Specifications	101
7.1.2	Measurement Accuracy	102
7.1.3	Output Function	104
7.1.4	Functional Specifications	105
7.1.5	General Specifications	105
7.1.6	Application Software	106
7.1.7	Equations and Functions	107
7.2	100 cm ² Magnetic Field Sensor	109
7.3	3 cm ² Magnetic Field Sensor	110
8	Maintenance and Service	111
<hr/>		
8.1	Troubleshooting	111
8.2	Error Indication	112
8.3	Version Display	112
8.4	Cleaning	112
8.5	Service	112
	Appendix	113
<hr/>		
	Appendix 1 ICNIRP Guideline (Basic Restrictions) ..	113
	Appendix 2 Coupling Factor in the ICNIRP Guidelines	114



Introduction

Thank you for purchasing the HIOKI "Model FT3470-51, -52 Magnetic Field Tester." To obtain maximum performance from the instrument, please read this manual first, and keep it handy for future reference.

This instruction manual contains instructions for use of the device with the 100 cm² and 3 cm² Magnetic Field Sensor.



Note

While every effort has been made to ensure that the content of this manual is correct, we would appreciate it if you notified your dealer or local Hioki agent should you notice any unclear, incorrect or missing information.



Trademarks

Microsoft and Windows are either registered trademarks or trademarks of Microsoft Corporation in the United States and other countries.



Notation

- Unless otherwise specified, "Windows" represents Windows XP, Windows Vista, Windows 7.
- Dialog box represents a Windows dialog box.
- Menus, commands, dialogs, buttons in a dialog, and other names on the screen and the keys are indicated in brackets.



Mouse Operation

Click:	Press and quickly release the left button of the mouse.
Right-click:	Press and quickly release the right button of the mouse.
Double click:	Quickly click the left button of the mouse twice.
Drag:	While holding down the left button of the mouse, move the mouse and then release the left button to deposit the chosen item in the desired position.
Activate:	Click on a window on the screen to activate that window.

Inspection

Verifying Package Contents

When you receive the instrument, inspect it carefully to ensure that no damage occurred during shipping. If damage is evident, or if it fails to operate according to the specifications, contact your dealer or Hioki representative.

FT3470-51 Magnetic Field Tester

FT3470-50 (1)



CD (PC application software) (1)



LR6 alkaline battery (4)



USB cable (1)

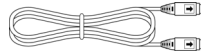

Instruction manual (1)

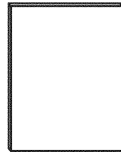

9445-02 AC Adapter (1)

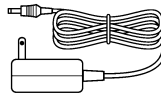

100 cm² Magnetic Field Sensor(1)

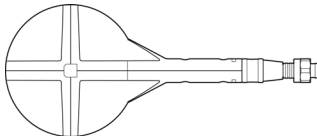

Carrying Case (1)



FT3470-52 Magnetic Field Tester

FT3470-50 (1)



CD (PC application software) (1)



USB cable (1)

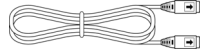

Instruction manual (1)

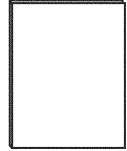

LR6 alkaline battery (4)



9445-02 AC Adapter (1)

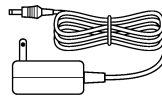

100 cm² Magnetic Field Sensor (1)

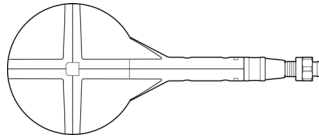

3 cm² Magnetic Field Sensor (1)

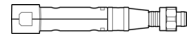

9758 Extension Cable (1)

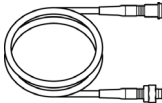

9759 Output Cable (1)

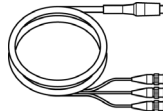

Carrying Case (1)



NOTE

This instrument has been calibrated to operate with the provided magnetic field sensor and should be used only with this sensor. Thus if multiple instruments are used, Before use make sure that the matching number (up to the hyphen) on the tester and the sensor are identical.

Shipping precautions

Use the original packing materials when transporting the instrument, if possible.

Safety Information









This instrument is designed to comply with IEC 61010 Safety Standards, and has been thoroughly tested for safety prior to shipment. However, mishandling during use could result in injury or death, as well as damage to the instrument. Using the instrument in a way not described in this manual may negate the provided safety features.



Be certain that you understand the instructions and precautions in the manual before use. We disclaim any responsibility for accidents or injuries not resulting directly from instrument/ defects.

This manual contains information and warnings essential for safe operation of the instrument and for maintaining it in safe operating condition. Before using it, be sure to carefully read the following safety precautions.



Safety Symbols

	In the manual, the  symbol indicates particularly important information that the user should read before using the instrument.
	The  symbol printed on the instrument indicates that the user should refer to a corresponding topic in the manual (marked with the  symbol) before using the relevant function.
	Indicates DC (Direct Current).
	Indicates AC (Alternating Current).

The following symbols in this manual indicate the relative importance of cautions and warnings.

 <u>DANGER</u>	Indicates that incorrect operation presents an extreme hazard that could result in serious injury or death to the user.
 <u>WARNING</u>	Indicates that incorrect operation presents a significant hazard that could result in serious injury or death to the user.
 <u>CAUTION</u>	Indicates that incorrect operation presents a possibility of injury to the user or damage to the instrument.
<u>NOTE</u>	Indicates advisory items related to performance or correct operation of the instrument.

Symbols for Various Standards

	<p>WEEE marking: This symbol indicates that the electrical and electronic appliance is put on the EU market after August 13, 2005, and producers of the Member States are required to display it on the appliance under Article 11.2 of Directive 2002/96/EC (WEEE).</p>
	<p>Indicates that the product conforms to regulations set out by the EU Directive.</p>

Other Symbols

(p.)	Indicates the location of reference information.
*	Indicates that descriptive information is provided below.
	Indicates a prohibited action.

Measurement Categories

The applicable measurement category is determined by the input module being used.

To ensure safe operation of measurement instruments, IEC 61010 establishes safety standards for various electrical environments, categorized as CAT II to CAT IV, and called measurement categories.

- CAT II : Primary electrical circuits in equipment connected to an AC electrical outlet by a power cord (portable tools, household appliances, etc.)
CAT II covers directly measuring electrical outlet receptacles.
- CAT III : Primary electrical circuits of heavy equipment (fixed installations) connected directly to the distribution panel, and feeders from the distribution panel to outlets.
- CAT IV : The circuit from the service drop to the service entrance, and to the power meter and primary overcurrent protection device (distribution panel).

Using a measurement instrument in an environment designated with a higher-numbered category than that for which the instrument is rated could result in a severe accident, and must be carefully avoided.

Use of a measurement instrument that is not CAT-rated in CAT II to CAT IV measurement applications could result in a severe accident, and must be carefully avoided.

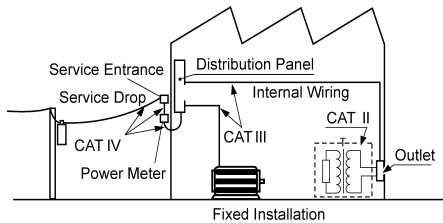

Do not touch high voltage lines with the sensor or the instrument. They are not insulated and the application of high voltage to this instrument may expose testing personnel to high voltage that may at worst lead to electric shock and death.



Operating Precautions

Follow these precautions to ensure safe operation and to obtain the full benefits of the various functions.

Preliminary Checks







- Before using the instrument the first time, verify that it operates normally to ensure that no damage occurred during storage or shipping. If you find any damage, contact your dealer or Hioki representative.
- Before using the instrument, make sure that the insulation on the cables is undamaged and that no bare conductors are improperly exposed. Using the instrument in such conditions could cause an electric shock, so contact your dealer or Hioki representative for repair.

Installation Environment

Operating temperature/humidity range: 0°C to 40°C, 80%RH or less (no condensation)

Temperature and humidity for guaranteed accuracy: -10°C to 50°C, 80%RH or less (no condensation)

Avoid the following locations that could cause an accident or damage to the instrument.

	<p>Exposed to direct sunlight Exposed to high temperature</p>		<p>In the presence of corrosive or explosive gases</p>
	<p>Exposed to water, oil, other chemicals, or solvents Exposed to high humidity or condensation</p>		<p>Exposed to strong electromagnetic fields Near electromagnetic radiators</p>
	<p>Exposed to high levels of particulate dust</p>		<p>Subject to vibration</p>



To avoid damage to the instrument, protect it from physical shock when transporting and handling. Be especially careful to avoid physical shock from dropping.

Connections



Connect only designated devices to the instrument terminals. To prevent damage, do not apply a voltage that is outside the specified range to the instrument.

Handling



- The instrument and the 100 cm² and 3 cm² Magnetic Field Sensors are built mainly from nonmagnetic metals and contain hardly any magnetic materials. Thus if the instrument is heated by an all metal IH and other induction heating system the sensor may melt or be damaged, because of the nonmagnetic metals.
- The 100 cm² and 3 cm² Magnetic Field Sensors have a plastic housing that may melt if brought into contact with a hot measurement object (cookpot or other hot object).
- Do not expose cables to excessive stress as they may break. Especially, the 9758 Extension Cable and 9759 Output Cable should be handled with care.

Handling with the CD



- Always hold the disc by the edges, so as not to make fingerprints on the disc or scratch the printing.
- Never touch the recorded side of the disc. Do not place the disc directly on anything hard.
- Do not wet the disc with volatile alcohol or water, as there is a possibility of the label printing disappearing.
- To write on the disc label surface, use a spirit-based felt pen. Do not use a ball-point pen or hard-tipped pen, because there is a danger of scratching the surface and corrupting the data. Do not use adhesive labels.
- Do not expose the disc directly to the sun's rays, or keep it in conditions of high temperature or humidity, as there is a danger of warping, with consequent loss of data.
- To remove dirt, dust, or fingerprints from the disc, wipe with a dry cloth, or use a CD cleaner. Always wipe radially from the inside to the outside, and do no wipe with circular movements. Never use abrasives or solvent cleaners.
- Hioki shall not be held liable for any problems with a computer system that arises from the use of this CD, or for any problem related to the purchase of a Hioki product.

Overview

1

1

1.1 Product Overview

The FT3470-51, -52 Magnetic Field Tester is designed to measure magnetic flux density and level of magnetic field exposure.

- It can be used to assess conformance to ICNIRP 2010 and IEC/EN62233 and in research on magnetic field exposure.
- The instrument is designed to be used with the 100 cm² and 3 cm² Magnetic Field Sensors.

Make sure that the matching number (up to the hyphen) on the tester and the magnetic field sensor are identical.

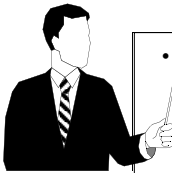

- Magnetic field exposure refers to the exposure that may affect human health.
The FT3470-51, -52 Magnetic Field Tester can be used to measure conformance to **Guidelines for Limiting Exposure to Time-varying Electric, Magnetic, and Electromagnetic Fields** (ICNIRP 2010) and a standard for **measuring magnetic fields of electrical household appliances** (IEC/EN62233).

[See For more information on ICNIRP: "Appendix" \(P.113\)](#)

- This tester can measure magnetic flux density and magnetic field exposure generated by products manufactured at a customer site or produced by devices in a customer environment.
It can measure magnetic flux density and magnetic field exposure generated by products manufactured at a customer site or produced by devices in a customer environment.

Functions		Functions in detail	Reference
Basic	Magnetic flux density ^{*1} measurements	<p>Measuring the magnetic flux density of appliances and environments</p> <p>Magnetic flux density (10 Hz to 400 kHz): For wide range measurements of magnetic flux density</p> <p>Magnetic flux density (10 Hz to 2 kHz): For magnetic flux density of power frequencies</p> <p>Magnetic flux density (2 kHz to 400 kHz): For magnetic flux density of high frequencies other than power frequencies</p>	See 3.3 (P. 40)
	Exposure level ^{*2} measurements	<p>Measuring the exposure level of appliances and environments</p> <p>Exposure level (general public): This level is used for measuring exposure to magnetic fields prevalent in environments where we can assume the presence of people of all age groups and health conditions (people who are not normally aware of the presence of magnetic fields) as well as exposure to magnetic fields generated by appliances and other consumer devices manufactured to conform to IEC/EN62233 and other standards. This level corresponds to the general public exposure level in ICNIRP 2010.</p> <p>Exposure level (occupational): This level applies to measurements of exposure to magnetic fields in environments that involve adults only who are generally exposed under known conditions and are trained to be aware of potential risk and to take appropriate precautions. This level corresponds to the occupational exposure level in ICNIRP 2010.</p>	See 3.4 (P. 43) 3.5 (P. 50)
Application	Output functions	A function that makes it possible to output waveforms and resultant RMS value of magnetic flux density or exposure levels.	See 6.1 (P. 95)
	Application software use	<ul style="list-style-type: none"> • This function allows you to do the following: • to set up the FT3470-50 from your PC • to upload data saved on the FT3470-50 to your PC • to monitor RMS values 	See 5 (P. 71)

*1: Available units are T, G, and A/m and the magnetic permeability of air being $4\pi \times 10^{-7}$ H/m, the relationships between the different units are as follows: $1\text{T}=10^4\text{G}$, $1\text{A/m}=4\pi \times 10^{-7}\text{T}$.

*2: This value is obtained by inverse filtering of magnetic flux density values stated in the ICNIRP2010 Guideline.

Use the exposure level figures indicated for the general public in IEC/EN62233 or Since the reference levels for magnetic field exposure indicated in ICNIRP2010 for occupational exposure is approximately five times that of general public exposure, the indicated values for occupational exposure is roughly a fifth of general public exposure.

[See "Appendix" \(P.113\)](#)

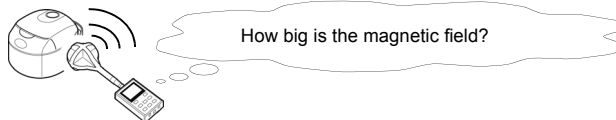

1.2 Features

◆ Easy to view LCD display

The large LCD display makes for ease of viewing measurement values.

◆ Automatic recognition of magnetic field sensors

Two magnetic field sensors of different sizes, the 100 cm² and 3 cm²*, are available for the tester

The 100 cm² sensor, intended for normal application, has a cross-sectional area of 100 cm².

The 3 cm² sensor* has a cross-sectional area of 3 cm² and is designed for measuring detailed distribution.

The FT3470-50 automatically recognizes an attached sensor so there is no need to set a conversion rate whenever a sensor is connected.

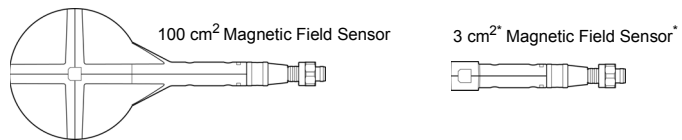

*: The 3 cm² Magnetic Field Sensor only ships with the FT3470-52.

◆ Switchable measurement methods

The tester allows the user to switch between the following measurement functions/modes: magnetic flux density, exposure (General Public), and exposure (Occup.).

◆ Switchable axis

The user can switch between different axes (X-axis, Y-axis and Z-axis and resultant RMS values) in each measurement mode

◆ **Waveform and resultant RMS value output**

Both waveform (**MON**) and resultant RMS (**REC**) output can be selected.

By connecting the instrument to an oscilloscope or recorder with the 9759 Output Cable, you can observe waveforms and record resultant RMS values.

Waveform output	out-	enables measurement of magnetic field waveforms when the tester is connected to an oscilloscope or recorder.
Resultant RMS value output	RMS	permits recording of resultant values on a recorder or logger, which is convenient for long-term measurements.

◆ **Memory function**

Records up to 99 measurement data.

◆ **Function for saving settings**

Measuring conditions can be stored to enable quick access to the same operating conditions each time you power up.

◆ **Dual power supply**

The tester can be powered both by battery and AC power to enable measurements in the field as well as permitting installation for long-term measurements.

1.3 Measurement Example

1

This section provides a measurement example using this tester.

Objective: to measure magnetic field exposure generated by products to determine whether they pass or fail the requirements to obtain a CE marking.

Measurement location : Anechoic chamber*1
Device under test : exposure level (general public) of magnetic fields generated by an electric rice cooker
Measurement location, distance*2 : around, 30 cm *3
State of device under test*2 : Half-filled with water, and maximum heat setting
Measurement time : a few seconds at each measurement point

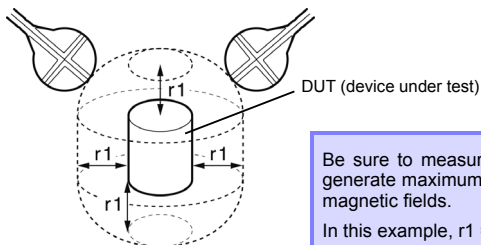

Storage of measurement data : tester memory and PC memory

Required equipment : FT3470-50
 100 cm² or 3 cm² Magnetic field sensor
 Batteries or AC adapter
 PC
 USB cable

*1: A location where magnetic fields other than that generated by the DUT is minimal and where there are no magnetic fields or metal objects in the vicinity that could be affected by the measurements. An anechoic chamber is not required if the above conditions can be met.

Measurements performed in an anechoic chamber should be performed at a certain distance from the walls, which are made of a magnetic material.

*2 : Since these parameters depend on the measurement target, it is necessary to refer to IEC/EN62233 or other relevant specifications.

*3 : This value comes from IEC62233 Ed.1.0. Note that it may change when the standard is revised.

1

Preparations

1. Insert batteries in the FT3470-50 or connect it to the AC adapter and fold out the back stand. Also connect the 100 cm² or 3 cm² Magnetic Field Sensors.

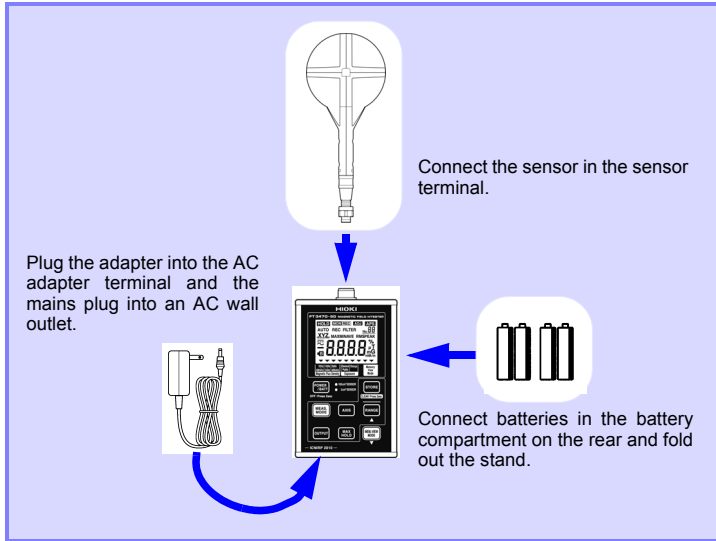

2. Install the driver and the PC software on a PC.
3. Connect the tester to the PC using a USB cable.

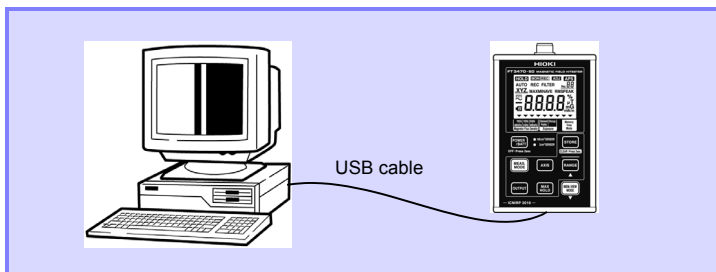

2

Setup, measurements and data storage

1. Select Exposure (general public) measurement function/mode (General Public Exposure).
2. Select Auto range. ([AUTO] on the display lights.)
3. Place the magnetic field sensor near the DUT. (A distance of 30 cm if the DUT is an electric cooker)

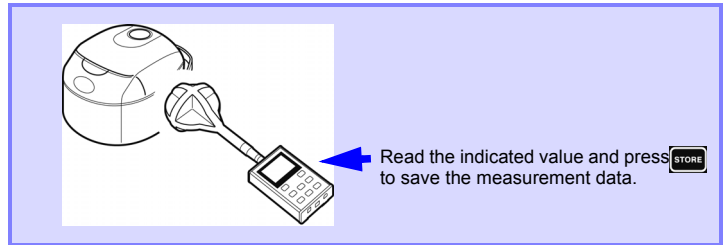

4. Read the indicated value and store the measurement data in the tester (STORE).

3

Processing data after measurement

1. Start up the Application software (Data Viewer for FT3470) and transfer the measurement data stored in the instrument to the PC.
2. Analyze the data transferred to the PC using Excel or other spreadsheet program.

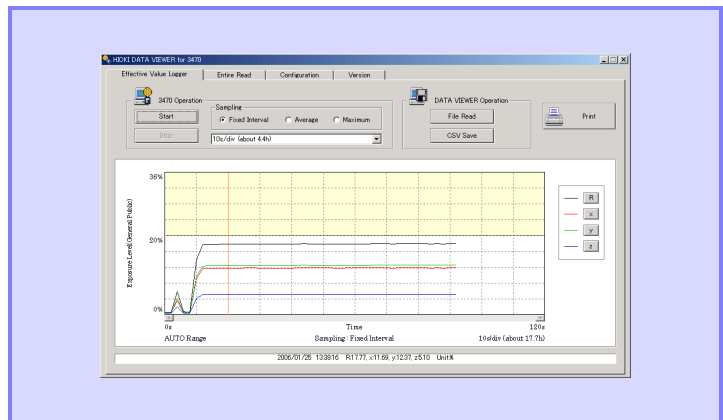

Analysis flow chart

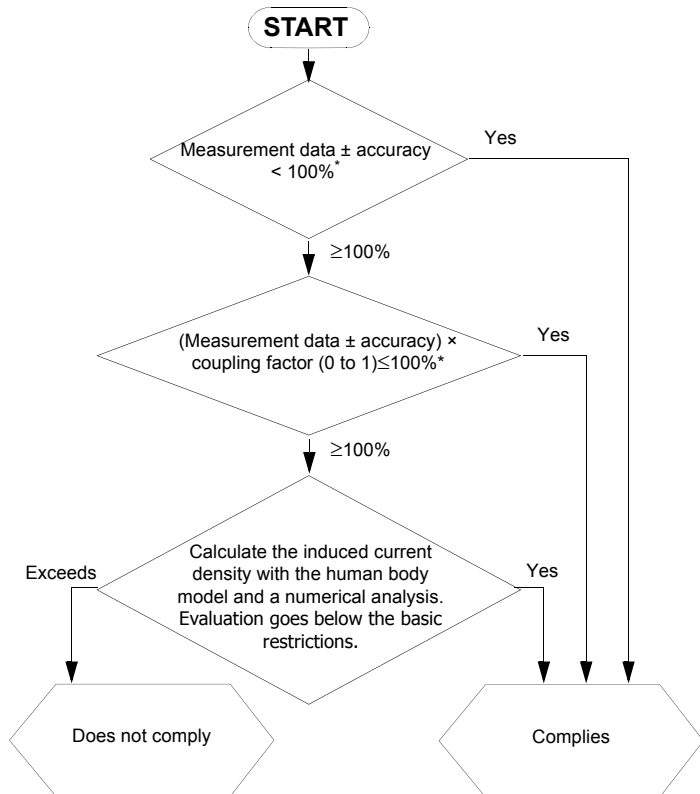

* : Whether tester accuracy should be added or subtracted depends on the standpoint of testing personnel. Refer to the instructions in the IEC62233 standards. For details on the coupling factor, refer to Appendix 2 "Coupling Factor in the IC-NIRP Guidelines" (P.114).

*2 : This cannot be measured by a magnetic field tester.

1.4 Names and Functions of Parts

1

1.4.1 FT3470-50 Magnetic Field Tester



Front

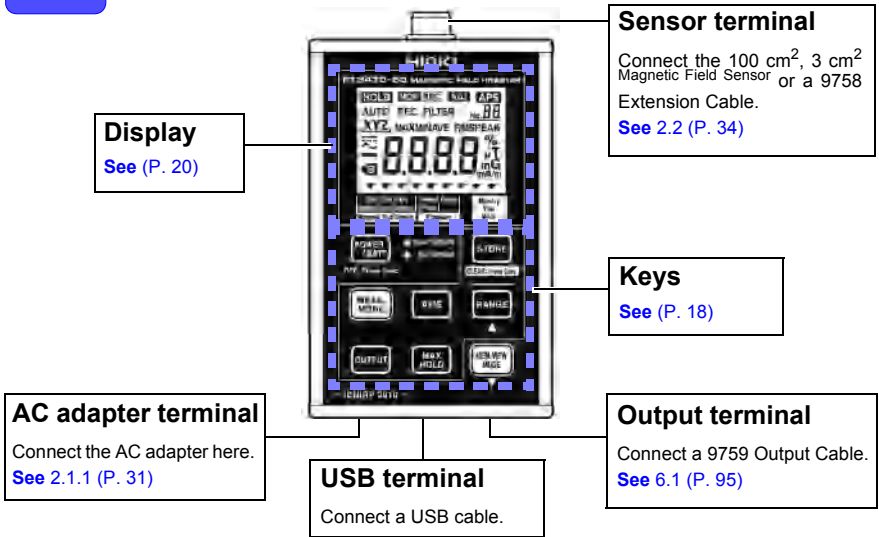



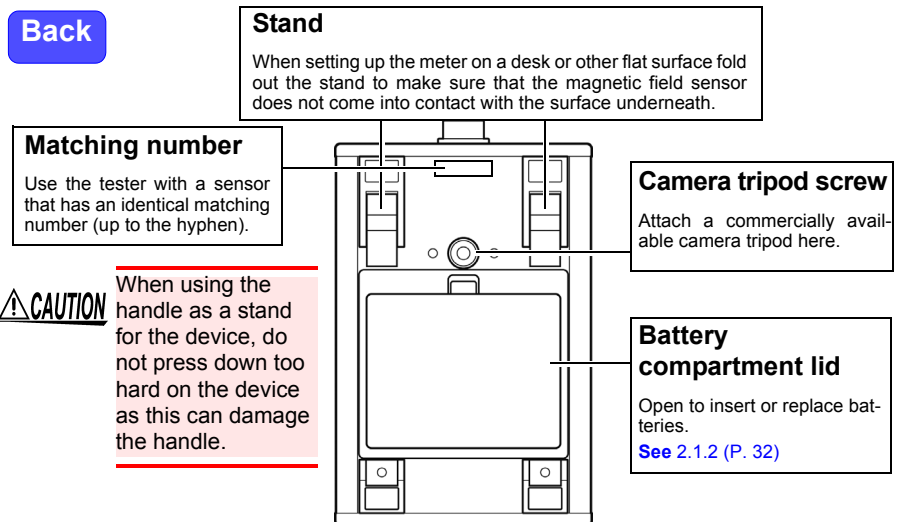



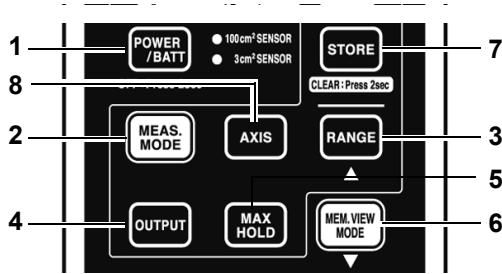



Back



keys



Keys	Description
1 	<ul style="list-style-type: none"> Turns the power on and off. Holding down  while turning on the power initializes the saved measurement data and the saved settings (returning them to their factory defaults). See For details on the factory defaults: 4.2 (P. 60) Holding down the  while powering up allows you to set the Auto power off, audible key feedback, unit indication, slow function, and MEM.MODE key enable/disable. See 4.3 (P. 61)
2 	<p>Switches magnetic field measurement function/modes as show below: Magnetic flux density (10 Hz to 400 kHz) → magnetic flux density (10 Hz to 2 kHz) → magnetic flux density (2 kHz to 400 kHz) → exposure level (General Public) → exposure level (Occup.) → magnetic field density (10 Hz to 400 kHz) → ... See 3.3 (P. 40)</p>
3 	<ul style="list-style-type: none"> Switches between Auto and Manual ranges. Manual range: (magnetic flux density mode) AUTO → r0 (2 μT) → r1 (20 μT) → r2 (200 μT) → r3 (2 mT) → AUTO... (exposure level mode) AUTO → r0 (20%) → r1 (200%) → AUTO... Auto range: automatically selects appropriate range during measurements. Switches measurement ranges during manual range. See 3.3 (P. 40) Magnetic flux density switching is performed by converting from T (Tesla). For this reason, for example, 1.592 A/m is the maximum indicated value in the 1.6 A/m range.
4 	<ul style="list-style-type: none"> Use to output function. Switches between the following output functions. OFF → Waveform output → resultant RMS value output → OFF... This mode disables the auto power off mode. The waveform output cannot be configured in exposure level function. See 6.1 (P. 95)
5 	<ul style="list-style-type: none"> Holds the maximum value. (Each new maximum value updates the indicated value.) Press this key again to unhold. See 3.6 (P. 53)
6 	<p>Shows saved measurement data. See 3.7 (P. 54)</p>

	Keys	Description
7		<ul style="list-style-type: none"> • Stores measurement data in internal memory. • Deletions displayed measurement data when viewing memory data. • This key becomes invalid during MAX.HOLD. <p>See 3.7 (P. 54)</p>
8		<p>Switches the displayed axis as shown below: XYZ→X→Y→Z→XYZ...(XYZ indicates a resultant RMS value*) *: $\sqrt{X^2+Y^2+Z^2}$ </p> <p>See 1.5 "Definition of Measurement Items" (P.23)</p>

Note: Icons not described below cannot be used with this tester.

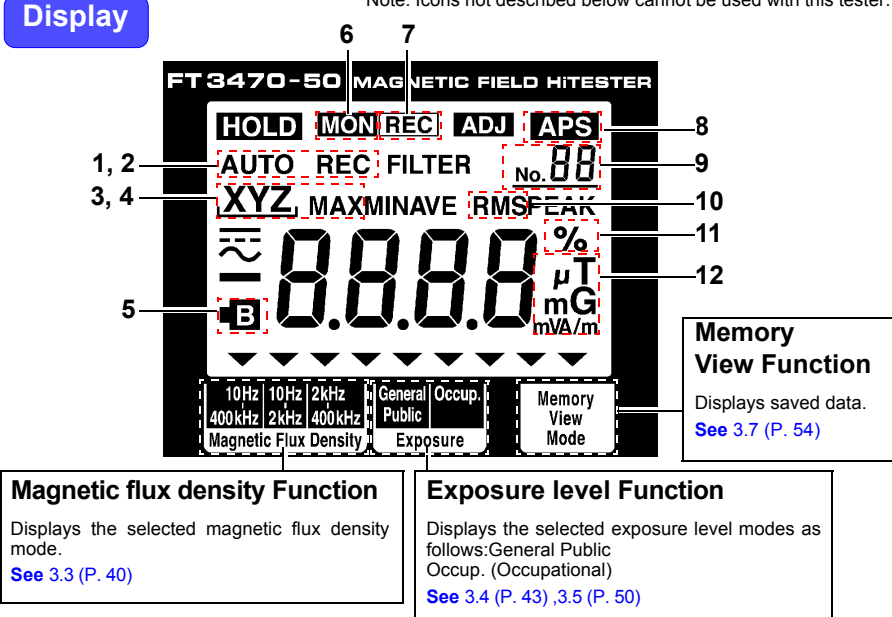

Icons		Description
1	AUTO	Lights when Auto Range is selected.
2	REC	Lights when measurement data is being stored.
3	XYZ	Shows displayed axis. (XYZ indicates a resultant RMS value*.) * $\sqrt{X^2+Y^2+Z^2}$ See 1.5 "Definition of Measurement Items" (P.23)
4	MAX	Lights when holding a maximum value. See 3.6 "Holding Maximum Value of the Resultant RMS Values" (P.53)
5	B	Lights when battery voltage becomes too low. (Replace the batteries when this icon lights.) See "Function for checking low battery voltage" (P.38)
6	MON	Lights during output of waveform.
7	REC	Lights during output of a resultant RMS value.
8	APS	Lights when automatic power off is on.
9	No. 88	Indicates the number of the measurement data stored in memory. See 3.7 "Checking and Deleting Saved Measurement Data" (P.54)
10	RMS	Indicates that a measurement value is an RMS value. Flashes during the slow function is on.
11	%	Indicates the unit used for indicating exposure level. See 3.4 "Measuring Exposure Level (General Public)" (P.43) , 3.5 "Measuring Exposure Level (Occup.)" (P.50)
12	μT mG A/m	• Indicates the unit used for indicating magnetic flux density. See 3.3 "Measuring Magnetic Flux Density" (P.40)

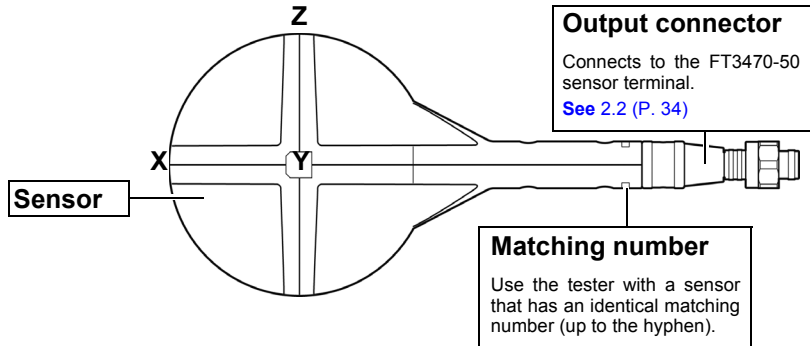
1.4.2 100 cm² Magnetic Field Sensor

X-axis coil

The dotted line indicates the X-axis coil.

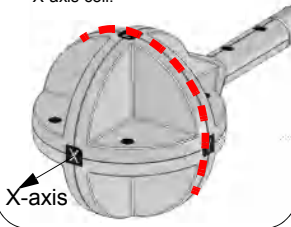

Y-axis coil

The dotted line indicates the Y-axis coil.

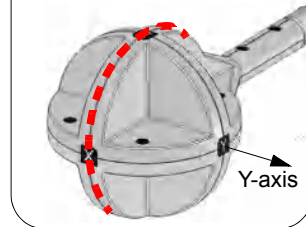

Z-axis coil

Z-axis

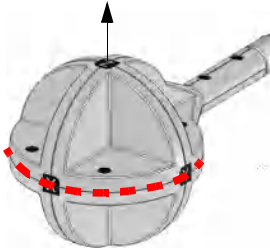

The dotted line indicates the Z-axis coil.

1.4.3 3 cm² Magnetic Field Sensor

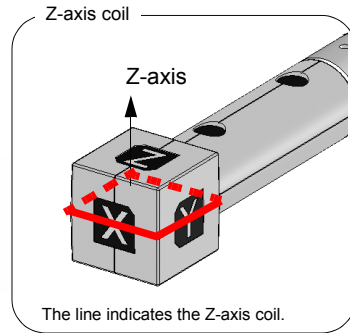
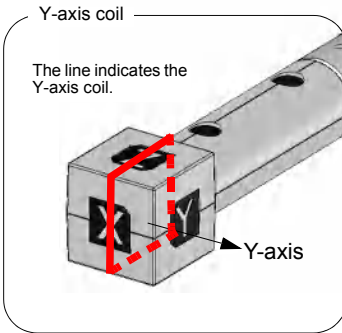
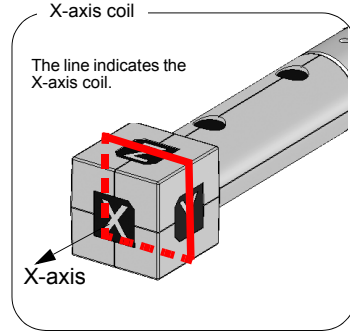
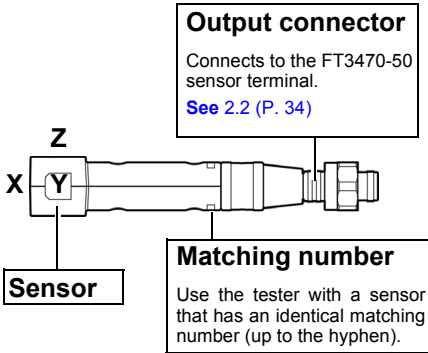

1.5 Definition of Measurement Items

1

Instantaneous values obtained from the X-axis, Y-axis and Z-axis sensors at time t are referred to as, respectively, $x(t)$, $y(t)$ and $z(t)$ while the RMS values are respectively $\hat{x}(t)$, $\hat{y}(t)$ and $\hat{z}(t)$. The RMS values used by this tester represent the values shown below. (T refers to the RMS integration time and is approximately 0.12 s when the slow function is turned off and about 1 s when the function is on.)

$$\hat{x}(t) = \sqrt{\frac{1}{T} \int_{t-T}^t \{x(t)\}^2 dt}$$

$$\hat{y}(t) = \sqrt{\frac{1}{T} \int_{t-T}^t \{y(t)\}^2 dt}$$

$$\hat{z}(t) = \sqrt{\frac{1}{T} \int_{t-T}^t \{z(t)\}^2 dt}$$

A resultant RMS value $\hat{R}(t)$ represents the following.

$$\hat{R}(t) = \sqrt{\{\hat{x}(t)\}^2 + \{\hat{y}(t)\}^2 + \{\hat{z}(t)\}^2}$$

NOTE

- The IEC/EN622336 standards state that "Transient magnetic fields with a duration of less than 200 ms, e.g. during switching events, are disregarded. If a switching action occurs during the measurements, the measurement has to be repeated."

Transient responses may not be correctly measured when slow function is off. Make a new measurement if this happens.

- To make a 1 s measurement that includes transient responses, measure using the slow function.

See 4.3.4 "Setting the Slow Function" (P.67)

The above can be summarized as shown below.

Resultant RMS value:	$\hat{R}(t)$:	LCD reading, RMS output (REC)
RMS value (per axis):	$\hat{x}(t)$, $\hat{y}(t)$, $\hat{z}(t)$:	LCD reading
Instantaneous value (per axis):	$x(t)$, $y(t)$, $z(t)$:	Waveform output* (MON)

*:The waveform output (**MON**) cannot be configured in exposure level function.

NOTE

Resultant RMS and RMS values (for each axis) can be viewed on a PC using the application software (on CD) supplied with the tester.

See 5.1 "Overview" (P.71)

1.6 Screen Configuration and Key Operation Work Flow

See 3.3 (P. 40)

**Magnetic flux density function
10 Hz to 400 kHz mode**

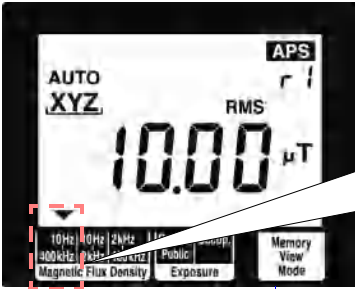

Measurement function/mode

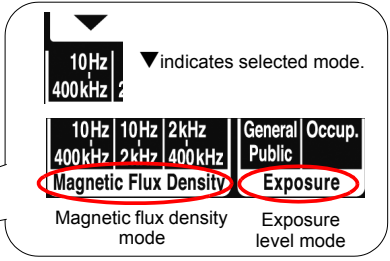

See 3.3 (P. 40)

**Magnetic flux density function
10 Hz to 2 kHz mode**

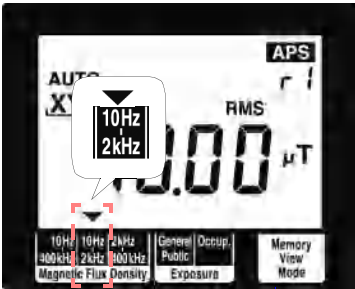

See 3.5 (P. 50)

**Exposure level
(Occup.) mode**

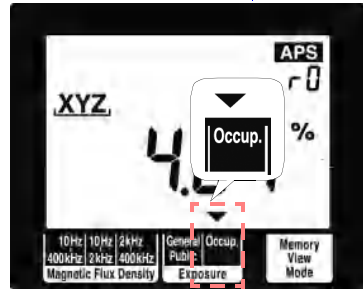

See 3.3 (P. 40)

**Magnetic flux density function
2 kHz to 400 kHz mode**

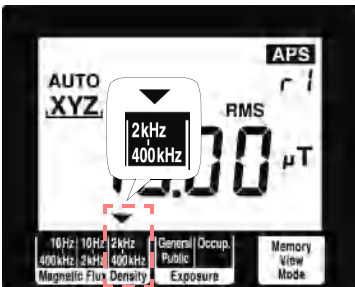

See 3.4 (P. 43)



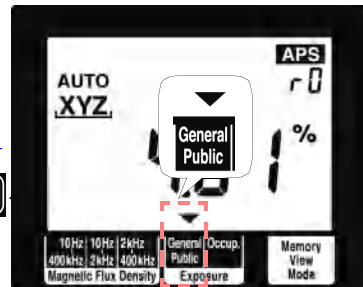









**Exposure level
(General Public) mode**



















Press

Screens for verifying and setup

1

Screen name	Screen access method	Screen displayed
Check Saved Measurement Data	Press  in each measurement function. See 3.7.1 (P. 54)	
Set Auto Power Off	When the power is off, hold down  and  and press  or  to turn on [APS]. See 4.3.1 (P. 61)	
Set Audible Key Feedback	When the power is off, hold down  and  . And press  or  to turn on [BEEP]. See 4.3.2 (P. 63)	

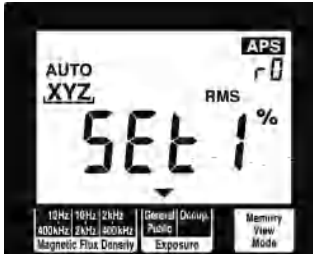
Screen name	Screen access method	Screen displayed
Change Unit Indication	When the power is off, hold down  and  . And press  or  to turn on [Unit]. See 4.3.3 (P.65)	
Set Slow Function	When the power is off, hold down  and  . And press  or  to turn on [SLou]. See 4.3.4 (P. 67)	
Enable/disable the MEM. MODE key when using MAX. HOLD or the output function	When the power is off, hold down  and  . And press  or  to turn on [MEM.M]. See 4.3.5 (P. 69)	
QuickSet The slow function is on in Exposure level (General Public) mode when powering on.	When the power is off, hold down  and  . See (P. 44)	

1.7 Measurement Work Flow

1

This section describes measurement work flow.

1. Supplying power

See 2.1.1 "Connecting the AC Adapter" (P.31)

See 2.1.2 "Inserting and Replacing Batteries" (P.32)

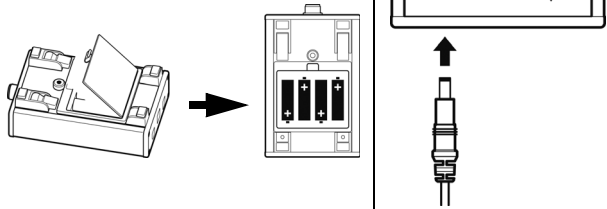

2. Connect a magnetic field sensor.

See 2.2 "Connecting a Magnetic Field Sensor" (P.34)

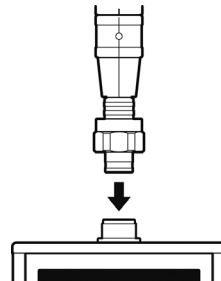



3. Turn on the power.

See 2.3 "Turning the Power On and Off" (P.35)

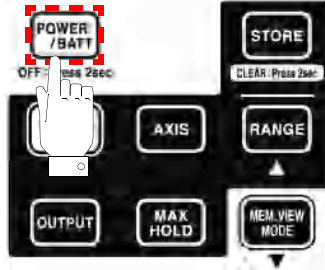

4. Pre-measurement check

See 3.2 "Pre-measurement Check" (P.39)



5. Measuring magnetic fields.

See 3.3 "Measuring Magnetic Flux Density" (P.40)

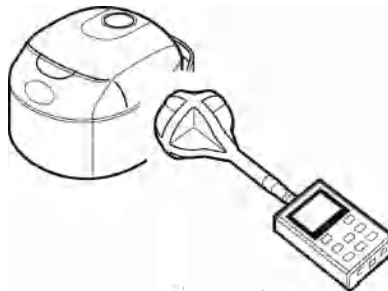



- 6.** Transfer the measurement data to a PC and use the application software to analyze the data.

See 5.3 "Graphic Representation of Measurement Values" (P.85)

See 5.4 "Transferring Recorded Data to a PC" (P.88)





Measurement Preparations 2

2.1 Supplying Power

2.1.1 Connecting the AC Adapter ⚠

⚠ WARNING Use only the specified Model 9445-02 AC Adapter AC adapter input voltage range is 100 to 240 VAC (with ±10% stability) at 50 Hz/60 Hz. To avoid electrical hazards and damage to the instrument, do not apply voltage outside of this range.

NOTE

- Make sure the power is turned off before connecting or disconnecting the AC adapter.
- Use the AC adapter for long-term measurements.

Connect the AC adapter according to the steps below

1. Connect the 9445-02 AC Adapter to the AC adapter terminal.

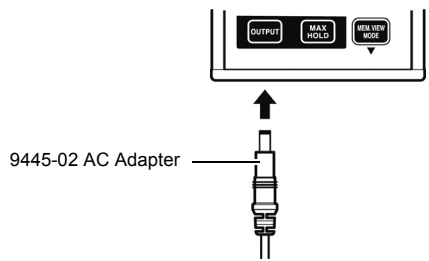

2. Connect the AC adapter plug to an AC wall outlet.

This completes AC adapter connection.

2.1.2 Inserting and Replacing Batteries



! WARNING

- Do not mix old and new batteries, or different types of batteries. Also, be careful to observe battery polarity during installation. Otherwise, poor performance or damage from battery leakage could result.
- To avoid the possibility of explosion, do not short circuit, disassemble or incinerate batteries.
- Handle and dispose of batteries in accordance with local regulations.
- To avoid corrosion and damage to this instrument from battery leakage, remove the batteries from the instrument if it is to be stored for a long time.

! CAUTION

To avoid corrosion and damage to this instrument from battery leakage, remove the batteries from the instrument if it is to be stored for a long time.

NOTE

- The  indicator appears when battery voltage becomes low. Replace the new batteries as soon as possible. (outside guaranteed accuracy)
- Use battery power to run the tester for brief measurement sessions in locations without AC power.
- Disconnecting and connecting the AC adapter during measurements when the tester is both battery and AC powered may cause the measurement values to fluctuate greatly.

Use the following steps to insert (replace) the batteries.

Required batteries: LR6 alkaline battery (4)

1. Remove the battery compartment lid.

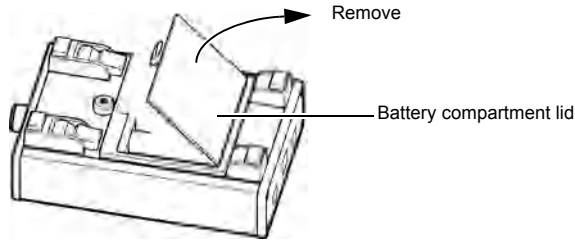

2

2. When replacing batteries, first remove the old batteries.
3. Insert the batteries taking care to match the polarity correctly.

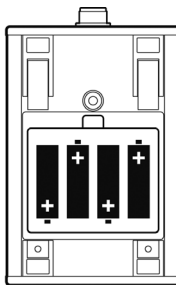

4. Attach the battery compartment lid.

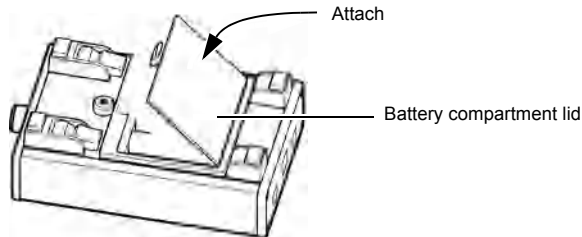

This completes the battery insertion (replacement) procedure.

2.2 Connecting a Magnetic Field Sensor



WARNING

Use the magnetic field sensor within its specified range. In a high frequency and strong magnetic field, the sensor will output a high voltage that may cause electric shock or sensor damage when someone touches an unconnected output terminal. Observe the rating and the derating curve of the sensor during operation.

Connect the magnetic field sensor (100 cm² or 3 cm²) according to the steps below.

The 100 cm² sensor, intended for normal application, has a cross-sectional area of 100 cm².

The 3 cm² sensor has a cross-sectional area of 3 cm² and is designed for measuring detailed magnetic field distribution.

Locate the Z-axis of the magnetic field sensor facing forward, insert the output connector of the sensor in the FT3470-50 sensor terminal and screw the nut of the sensor in to firmly attach the sensor.

The sensor automatically recognizes the connected magnetic field sensor.

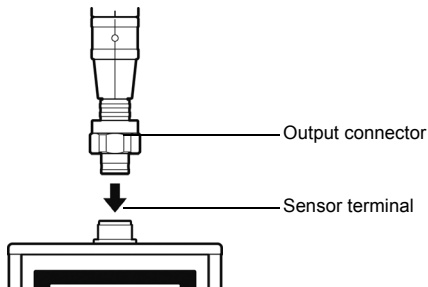

NOTE

To avoid damaging the output cable, grasp the connector, not the cable, when unplugging the cable.

This completes connection of 100 cm² and 3 cm² magnetic field sensors.

2.3 Turning the Power On and Off

Turn the power on (off) according to the steps below.

2

◆ Turning on the power

Press .

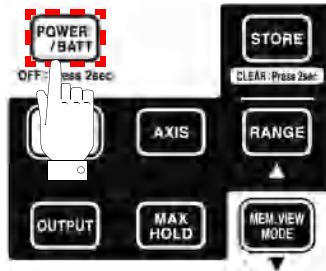

◆ Turning the power off

Hold down  for 2 seconds or more.

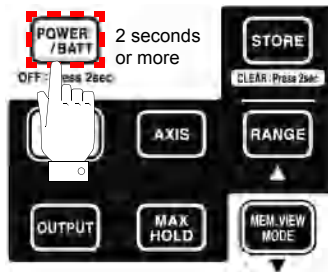

NOTE

To avoid battery depletion, turn the function selector OFF after use (the Auto Power Save feature consumes a small amount of current).



Measurement Procedure

3

3.1 Measurement Preparations

3

Before the start of measurements, make the following preparations in the stated order.

1. Press **POWER /BATT** to turn on the power.

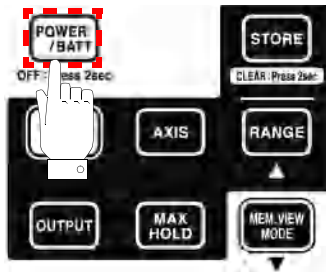

2. Make sure that all segments on the LCD display light.



Then it will display the model number and estimated remaining battery life.

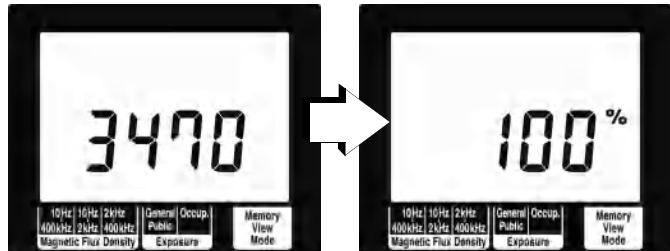

NOTE

The model number will be shown as "3470."

◆ **Function for checking low battery voltage**

When battery voltage goes low and **[B]** lights, the power is forcibly turned off. At this time, **[BAtt]** **[Lo]** also appear.

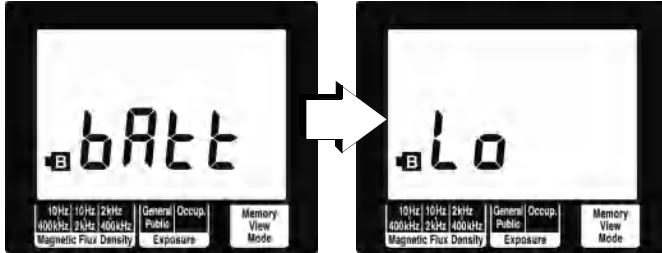

3. The magnetic flux density function screen appears.



This ends measurement preparations.

NOTE

- When a setup has been saved (for details refer to 4.1 "Function for Saving Settings (Saving Set Modes and Measurement Ranges)" (P.59)), the set measurement mode screen appears.
- To initialize the tester (to return it to its factory defaults), turn off the power and then hold down **[STORE]** and press **[POWER/BATT]**.

[See 4.2 "Initializing Function \(Returning Settings to Their Factory Defaults\)" \(P.60\)](#)

3.2 Pre-measurement Check

NOTE

This instrument has been calibrated to operate with the optional sensors and should be used only with these sensors. Thus if multiple instruments are used, make sure that each instrument is combined with the correct sensor.

Check the following before using the tester.

3

Inspection flow chart

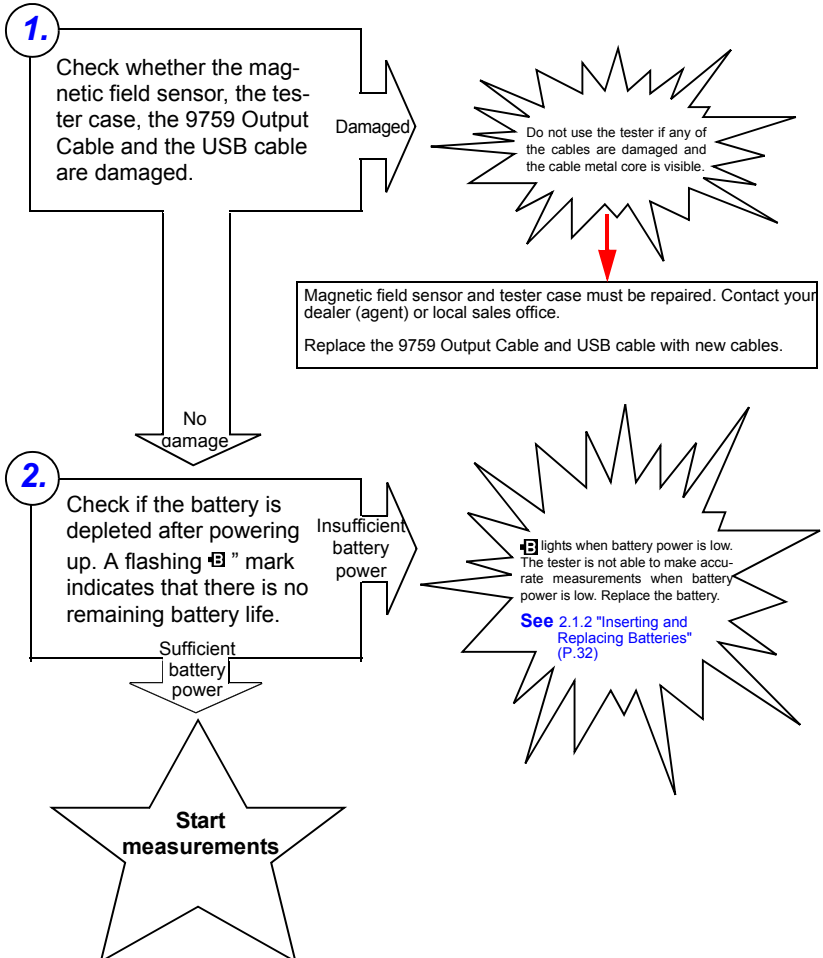

3.3 Measuring Magnetic Flux Density

Measure magnetic flux density according to the steps below.

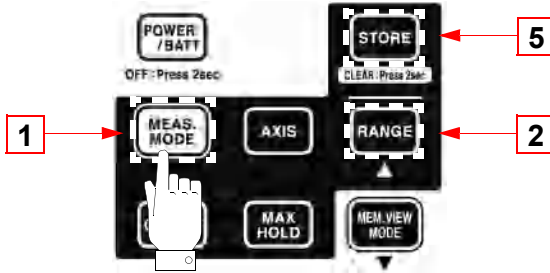

1. Press  to open the magnetic flux density function screen.

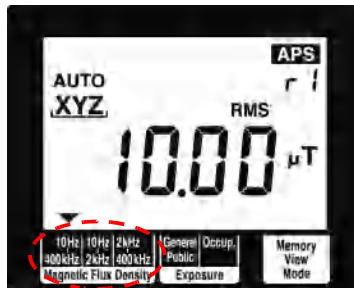

10Hz
400kHz

: wide range measurements

10Hz
2kHz

: power frequency range measurements

2kHz
400kHz

: extended power frequency range measurements

2. Press  to select measurement range.

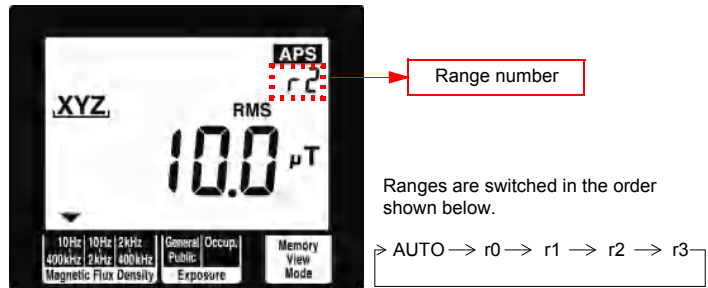

Range type	Range number	Range
Auto-range	AUTO appears on the display	Automatically selects appropriate range during measurements.
Manual range	r0	2 μ T
	r1	20 μ T/
	r2	200 μ T
	r3	2 mT

NOTE

- The ranges for the X, Y and Z axes are interlocked with maximum range and are automatically switched.

Range of guaranteed accuracy

At resultant RMS value R, a count of less than 100 is outside guaranteed accuracy.

Use an appropriate range.

Guaranteed accuracy range for resultant RMS value R

Magnetic flux density (10 Hz - 400 kHz, 10 Hz - 2 kHz, 2 kHz - 400 kHz)

Fixed range

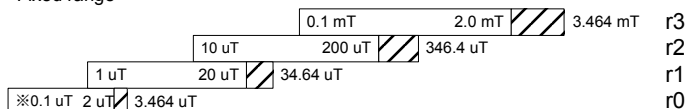

※The magnetic flux density for 3 cm^2 (10 Hz - 400 kHz, 10 Hz - 2 kHz) is 0.4 μ T.

3. Place the magnetic field sensor near the DUT.

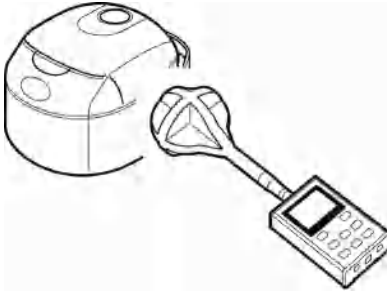
**NOTE**

- For accurate measurements, the tester should be located further away from the DUT than the magnetic field sensor.
- Although few magnetic materials are used in the magnetic field tester, the battery is a magnetic material and may affect measurements if located close to the DUT. In this situation, it may be a good idea to use an extension cable to increase the distance between the magnetic field sensor and the tester or to remove the battery and use the AC adapter.

4. Read the indicated value.

10.0 μT

5. Press **STORE** to save the measurement data.

This ends magnetic flux density measurements.

3.4 Measuring Exposure Level (General Public)

Use this mode to make measurements that conform to IEC/EN62233.

3.4.1 Preparing for Exposure Measurements

3

Use the flow chart below to determine whether to use the slow function setting.

◆ Slow function setting assessment flow chart

Use this test to determine whether the test of a household appliance should conform to IIEC/EN62233.

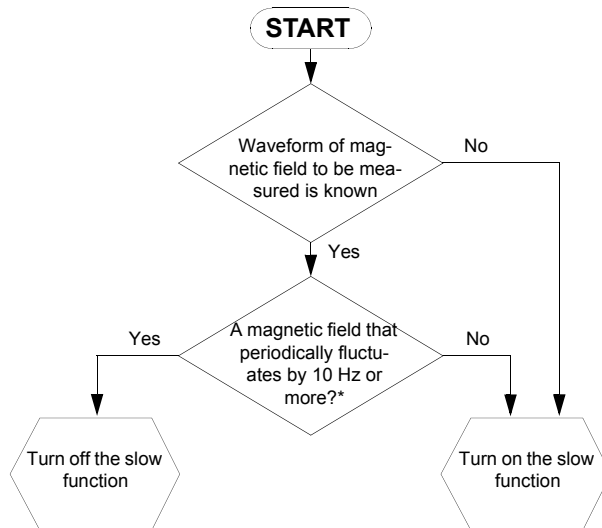



*: When measuring a magnetic field that periodically fluctuates by 10 Hz or more, turn off the slow function.

This is because moving the sensor causes the detection of AC current generated by a DC magnetic field such as the terrestrial magnetic field and other AC magnetic fields. Eight times the integral time is then required including processing time for the measurement value to stabilize.

- ◆ The result of the flow chart assessment is "Turn on the slow function."

Use the steps below to open the "QuickSet" screen. (An exposure level (General Public) measurement can be started after turning on the slow function.)

When the power is off, hold down  and press .

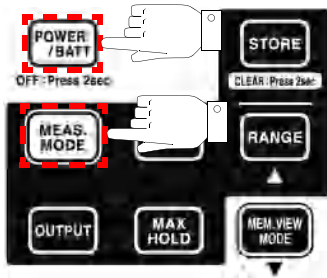

The "QuickSet" screen opens



After this follow the procedures 2. (P.48) described in 3.4.3 "Measurement Procedure" to perform an exposure level (General Public) measurement.

- ◆ The result of the flow chart assessment is "Turn off the slow function."

The result of the flow chart assessment is "Turn off the slow function." Turn off the slow function as described in 4.3.4 "Setting the Slow Function" (P.67). (The default setting is "Off.")

3.4 Measuring Exposure Level (General Public)

The table below shows the measurement and internal processing times with the slow function on and when it is off.

◆ Slow function on

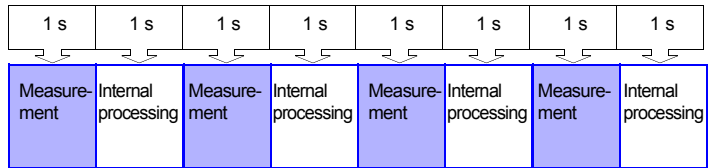

◆ Slow function off

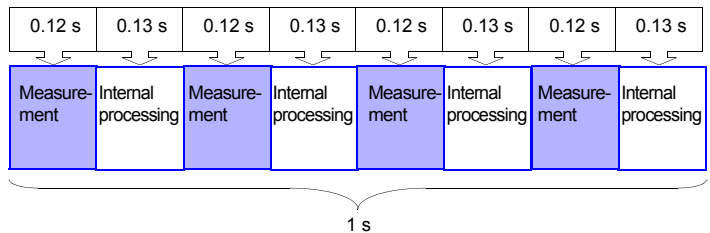

3.4.2 Exposure Level

NOTE

- Values obtained in an exposure measurement are not measures of the risk a specific magnetic field poses.
- In Exposure Level function, first order filters are used to approximate magnetic density flux levels in the ICNIRP guideline. Thus corner frequencies cause a difference of at most 3 dB, but this corresponds to the "smoothed edges" referred to in IEC/EN62233.
- A discussion of acute health effects of exposure must account for coupling factors such as the human body and magnetic fields, threshold values under basic restrictions and safety factors (reduction factor) for general public and occupational exposure.

Reference:

In IEC62233, the coupling factor at 10 cm as described in ICNIRP is "0.14" for small and "0.16" for large ones while the safety factor (reduction factor) (the reduction factor for public exposure is "50" (1/50 of the threshold value) for threshold values for occupational exposure is "10" (1/10 of the threshold value).

See :For details, see "Appendix" (P.113).

3.4 Measuring Exposure Level (General Public)

- In measuring non-uniform magnetic fields (see figure below) where the sensor may come into contact with a source, it is recommended that measurements be conducted at a distance from the three coils and at an angle (indicated by ● in the figure below) to maintain isotropy of each axis.
The IEC/EN62233 standards do not mention sensor angle.

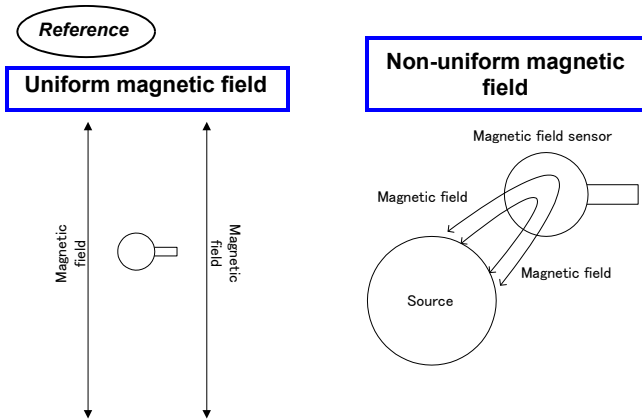

Measure at an angle away from the three coils

The locations indicated by ● (8 points on the spherical sensor surface) should be maintained in a vertical attitude relative to the DUT.

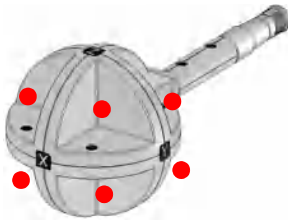

3.4.3 Measurement Procedure

Measure exposure level (General Public) according to the steps below.
General Public Exposure is selected.

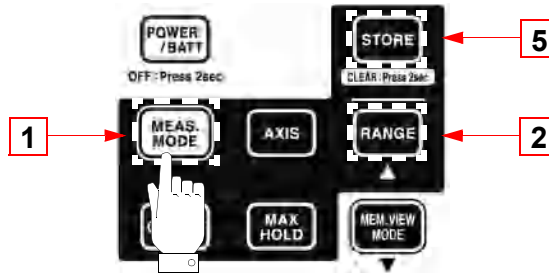

1. Press  to open the exposure level (General Public) mode screen.

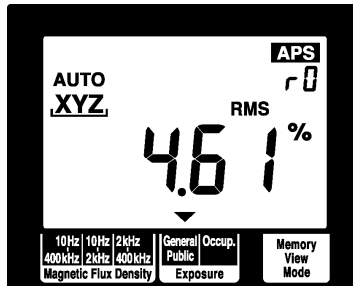

2. Press **RANGE** to select measurement range.

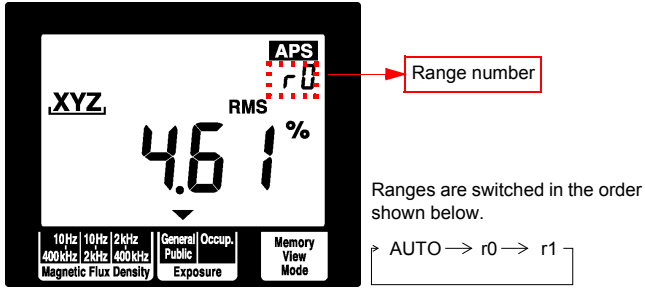

Ranges are switched in the order shown below.

AUTO → r0 → r1

Range type	Range number	Range
Auto-range	AUTO appears on the display	Automatically selects appropriate range during measurements.
Manual range	r0	20%
	r1	200%

NOTE

Range of guaranteed accuracy

At resultant RMS value R, a count of less than 100 is outside guaranteed accuracy.

As a result, when R is 9.9% or less in range r1, it is not within guaranteed accuracy.

Use an appropriate range.

Guaranteed accuracy range for resultant RMS value R

Exposure level (General Public, Occup.) Fixed range

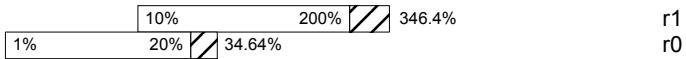

Guaranteed accuracy range Conditional guaranteed accuracy range (when none of X, Y, Z are O.L.)

3. Place the magnetic field sensor near the DUT.

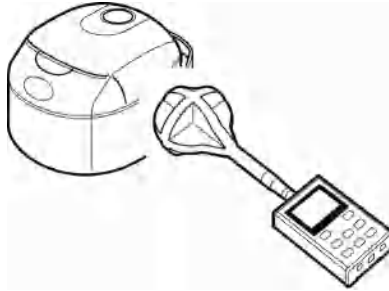

NOTE

- For accurate measurements, the tester should be located further away from the DUT than the magnetic field sensor.
- Although few magnetic materials are used in the magnetic field tester, the battery is a magnetic material and may affect measurements if located close to the DUT. In this situation, it may be a good idea to use an extension cable to increase the distance between the magnetic field sensor and the tester or to remove the battery and use the AC adapter.
- For details on measuring distance from DUT, sensor location and operating conditions, refer to the IEC/EN62233.
- The center of the 100 cm² magnetic field sensor is located at right angles to the X, Y and Z axes. Since the distance from the center to the spherical surface is 61 mm and the distance to the DUT is a mm, locate the tester so that the distance from the surface of the DUT to the center of the sensor is (a + 61 mm). Calculate the measurement distance from the surface of protrusions on the DUT.

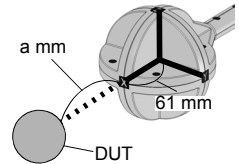

4. Read the indicated value.

4.52%

5. Press **STORE** to save the measurement data.

This ends exposure (General Public) measurements.

3.5 Measuring Exposure Level (Occup.)

Measuring Exposure Level (Occup.)

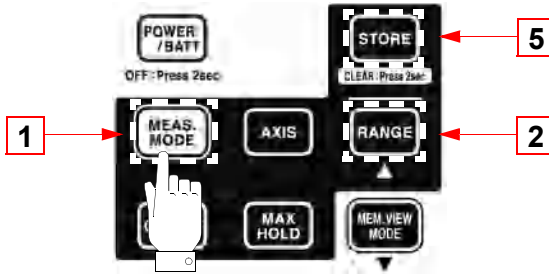

1. Press **MEAS. MODE** to open the exposure level (Occup.) mode screen. Occup. Exposure is selected.

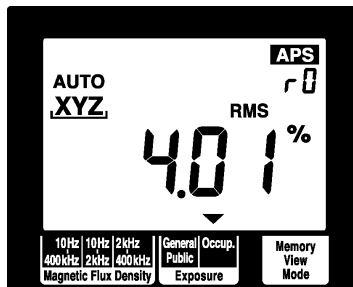

2. Press **RANGE** to select measurement range.

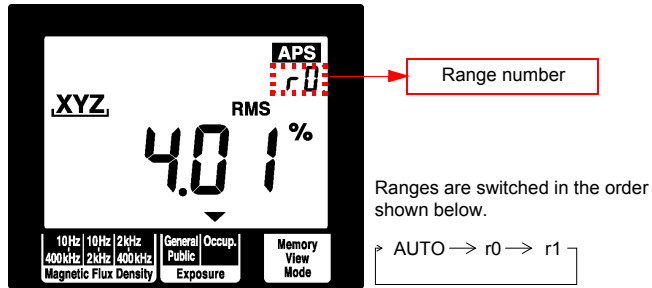

3

Range type	Range number	Range type
Auto-range	AUTO appears on the display	Automatically selects appropriate range during measurements.
Manual range	r0	20%
	r1	200%

NOTE

Range of guaranteed accuracy

At resultant RMS value R, a count of less than 100 is outside guaranteed accuracy.

As a result, when R is 9.9% or less in range r1, it is not within guaranteed accuracy.

Use an appropriate range.

Guaranteed accuracy range for resultant RMS value R

Exposure level (General Public, Occup.) Fixed range

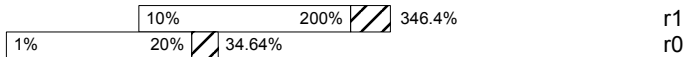

Guaranteed accuracy range Conditional guaranteed accuracy range (when none of X, Y, Z are O.L.)

3. Place the magnetic field sensor near the DUT.

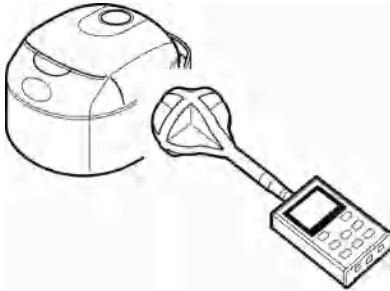
**NOTE**

- For accurate measurements, the tester should be located further away from the DUT than the magnetic field sensor.
- Although few magnetic materials are used in the magnetic field tester, the battery is a magnetic material and may affect measurements if located close to the DUT. In this situation, it may be a good idea to use an extension cable to increase the distance between the magnetic field sensor and the tester or to remove the battery and use the AC adapter.

4. Read the indicated value.

4.00 %

5. Press  to save the measurement data.

This ends exposure level (Occup.) measurements.

3.6 Holding Maximum Value of the Resultant RMS Values

This function holds the maximum value of the resultant RMS value R and the values of each axis.

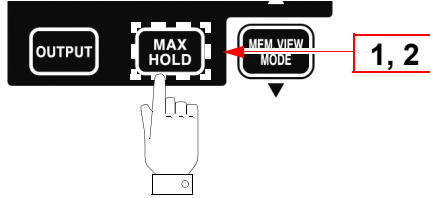

1. Press **MAX HOLD** to hold the maximum value of the resultant RMS value R and the **MAX** icon lights.

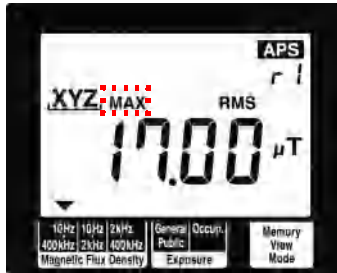

NOTE

The update of the maximum value will occur as a bigger resultant RMS value is observed. Therefore it is possible that the value of X, Y, or Z axis may decrease. **STORE** is invalid during MAX.HOLD and measurement data cannot be saved.

2. Press **MAX HOLD** again to turn off **MAX** and clear held maximum data value.

The screen returns to the state it had before **MAX HOLD** was pressed.

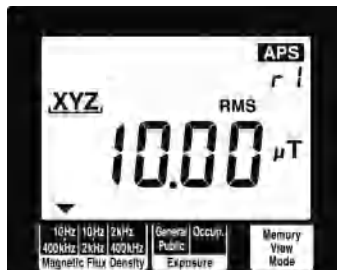

3.7 Checking and Deleting Saved Measurement Data

3.7.1 Checking Saved Measurement Data

Use the following steps to check saved measurement data. You can save up to 99 data.

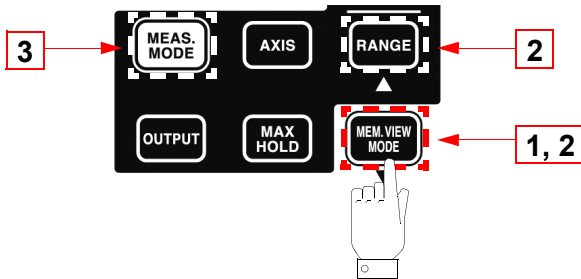

1. Press  to open the screen with the saved measurement data.



2. Press **[RANGE]** (▲) or **[MEM.VIEW MODE]** (▼) to select the memory number of measurement data you wish to check.

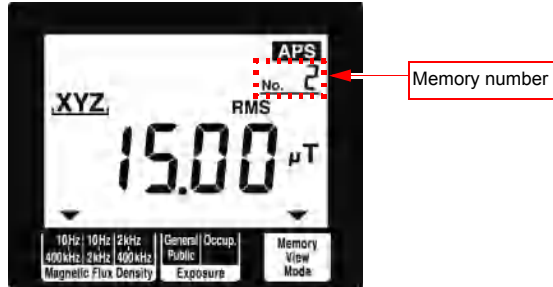

3. Press **[MEAS. MODE]** to return to the measurement function screen.



This completes saving measurement data

NOTE

RMS blinks when measurement data is saved with the slow function ON.

3.7.2 Deleting Saved Measurement Data

Use the following steps to delete saved measurement data.

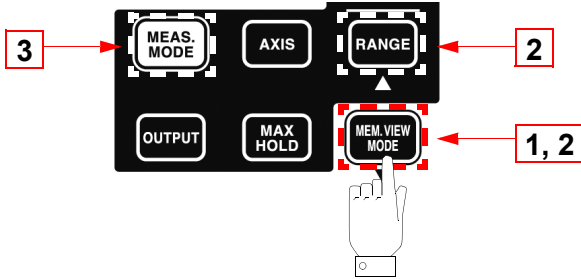

1. Press  to open the screen with the measurement data.



2. Press and hold  for 2 seconds or more.

This deletes the measurement data with the highest memory number.
Data can be deleted only when moved to the highest memory number.

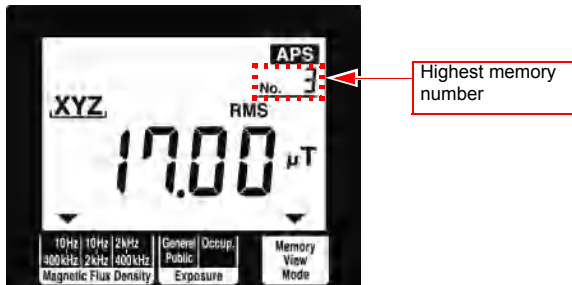

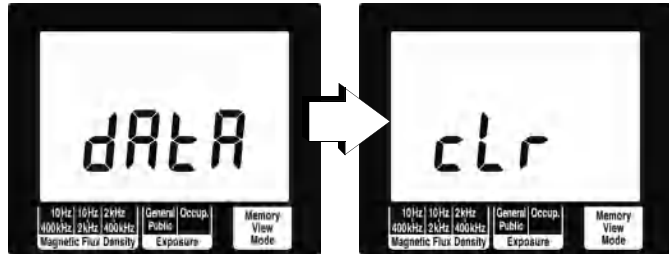

[dAtA] [cLr] appear when data is deleted.

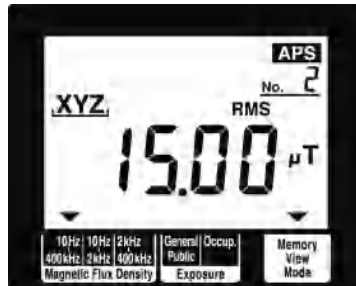

3

The measurement data for the next highest memory number appears.



3. Press  to return to the measurement function screen.



This completes deleting measurement data.

3.7.3 Deleting All Saved Measurement Data

Use the following steps to delete all saved measurement data.

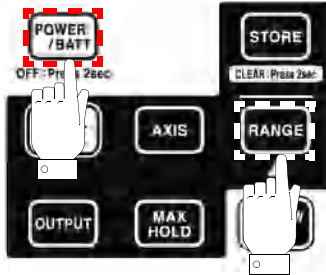

When the power is off, hold down **RANGE** and press **POWER/BATT**. This deletes all saved measurement data.

[dAtA] [cLr] appear when measurement data is deleted.

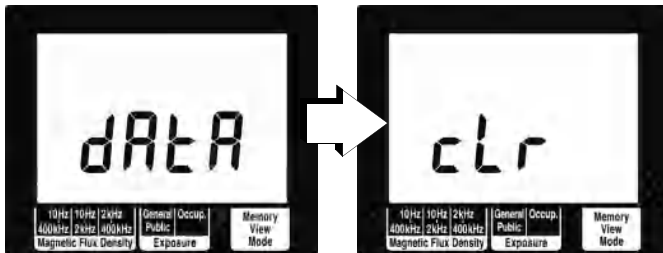

Then the model number, estimated remaining battery life and the measurement function screen appear.

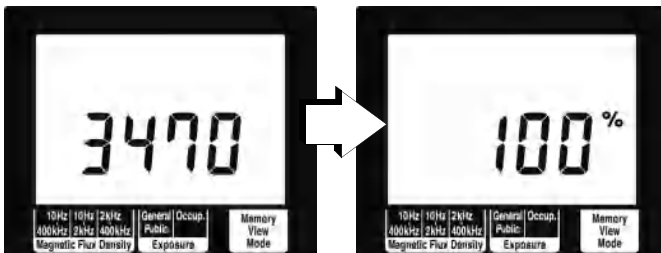

This completes deleting all saved data.

Advanced Functions

4

4.1 Function for Saving Settings (Saving Set Modes and Measurement Ranges)

A frequently used mode can be saved for immediate access. The saved mode appears as soon as the tester is powered up.

Follow the steps given below.

Select the mode or range you wish to access upon powering up and hold down  for 2 seconds or more.

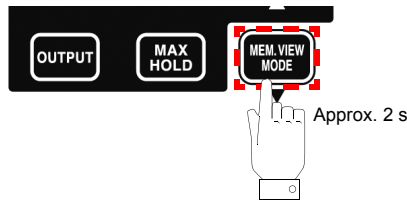

[SAvE] [End] appear and the tester returns to the screen prior to saving settings.

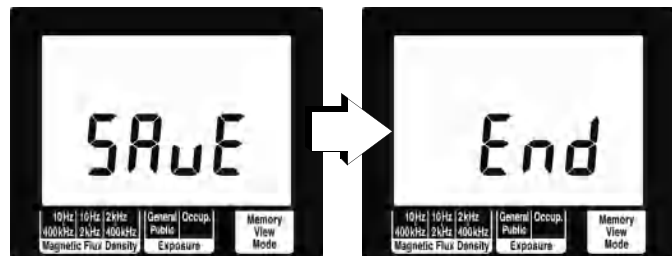

4.2 Initializing Function (Returning Settings to Their Factory Defaults)

This function initializes all settings returning them to their factory defaults and deletes all saved data. Follow the steps given below.

When the power is off, hold down **STORE** to press **POWER / BATT**.

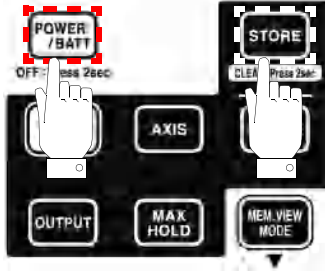

[All clr] appears.

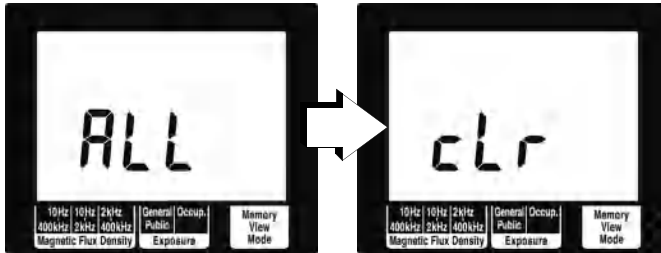

After this it displays the model number and estimated remaining battery life, and is restarted using the factory default settings.

The factory default settings are listed in the table below.

Item	Settings
Function / Mode	Magnetic flux density (10 Hz to 400 kHz)
Range	AUTO
Output	None
Auto power off	Enabled
Buzzer	Enabled
Axis	XYZ
Slow function	OFF
Unit	T

4.3 Other Functions

The following sections describe other functions that a user should know.

4.3.1 Setting Auto Power Off (Saving Battery Power)

- This function saves battery power when the user forgets to turn off the power.
- The tester is automatically turned off 10 minutes after the last key press.
- **APS** lights when the auto power off function is on. Before turning off the tester, the **APS** icon flashes and sounds a buzzer tone (for about 30 s). Pressing any key during this interval postpones shutdown by 10 minutes.

Follow the steps given below.

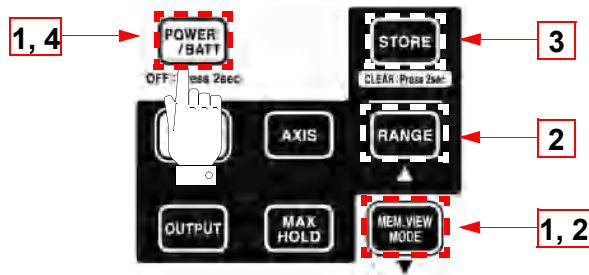

1. When the power is off, hold down **MEM. VIEW MODE** and press **POWER / BATT**.
2. Press **RANGE** (**▲**) or **MEM. VIEW MODE** (**▼**) to turn on **APS**.

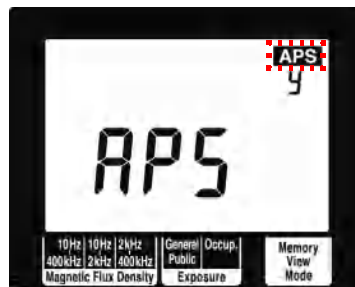

3. Press **STORE** and select [y] or [n].

[y] : set auto power off.

[n] : cancel auto power off.



4. Press **POWER/BATT** to save the setting.
[SAVE] [End] appear and the power is turned off.

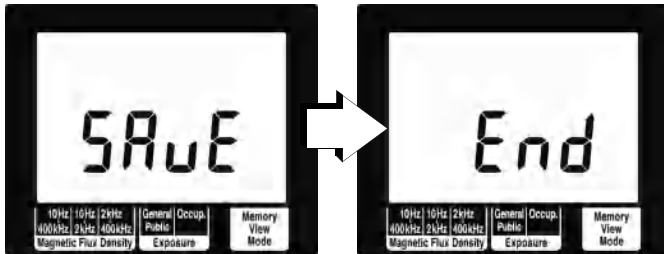





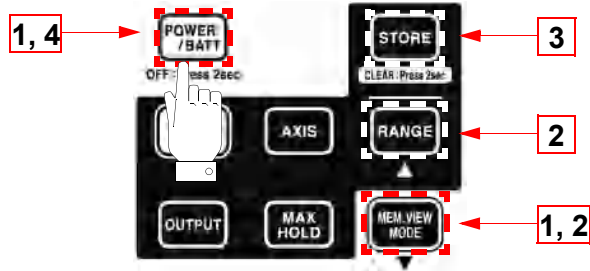

4.3.2 Setting Audible Key Feedback

This function causes the keys to generate a beep when pressed.

Follow the steps given below.



1. When the power is off, hold down  and press .
2. Press  () or  () to turn on [bEEP].

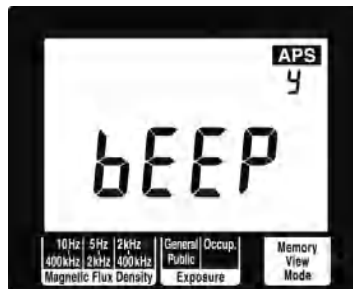

3. Press **STORE** and select [y] or [n].

[y] : audible key feedback is on.

[n] : audible key feedback is off.



4. Press **POWER / BATT** to save the setting.
[SAVE] [End] appear and the power is turned off.

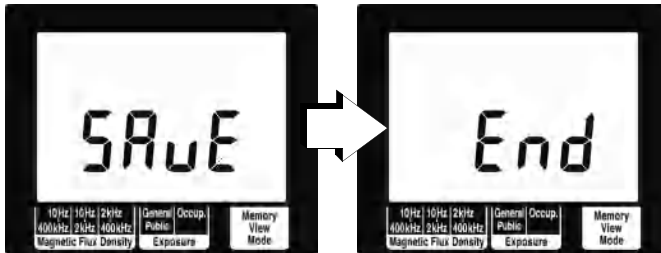



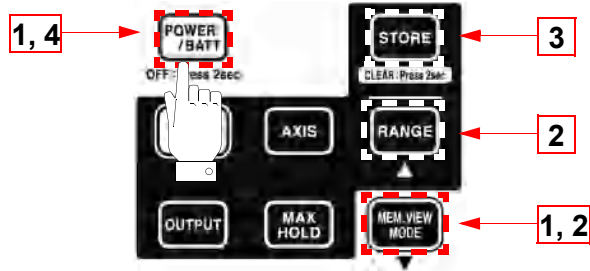

4.3.3 Changing Unit Indication

Use this function to change the unit indication. (The default unit is T.)

Follow the steps given below.



1. When the power is off, hold down  and press .
2. Press  (\blacktriangle) or  (\blacktriangledown) to turn on [Unit].



3. Press **STORE** and select [T], [G], or [A/m].

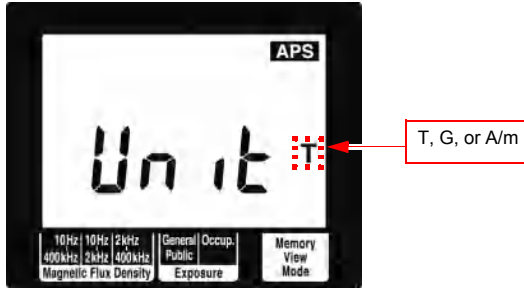

4. Press **POWER / BATT** to save the setting.
[SAVE] [End] appear and the power is turned off.

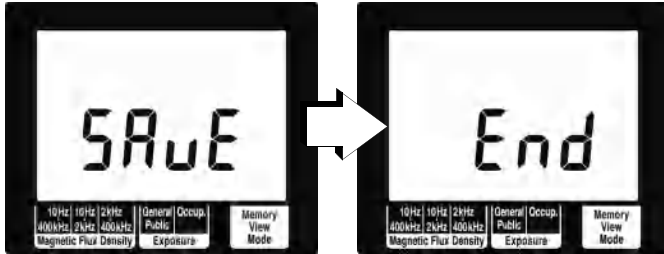

Measured axes	Unit	Maximum display of range			
		r0	r1	r2	r3
X, Y, Z	T	2.000 μ T	20.00 μ T	200.0 μ T	2.000 mT
	G	20.00 mG	200.0 mG	2.000 G	20.00 G
	A/m	1.592 A/m	15.92 A/m	159.2 A/m	1592 A/m
R	T	3.464 μ T	34.64 μ T	346.4 μ T	3.464 mT
	G	34.64 mG	346.4 mG	3.464 G	34.64 G
	A/m	2.757 A/m	27.57 A/m	275.7 A/m	2757 A/m

4.3.4 Setting the Slow Function

This function performs 1 s sampling and then displays the measurement value.

Follow the steps given below.

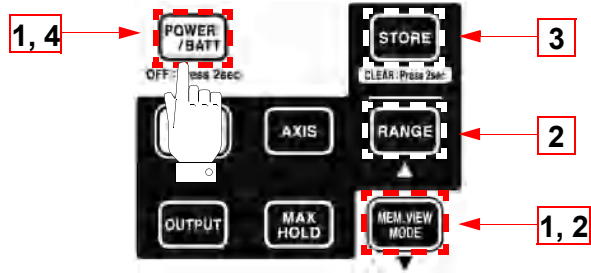

1. When the power is off, hold down **MEM.VIEW MODE** and press **POWER /BATT**.
2. Press **RANGE** (**▲**) or **MEM.VIEW MODE** (**▼**) to turn on [SLou].



3. Press **STORE** and select [y] or [n].

[y]	:	sets the slow function.
[n]	:	cancels the slow function.



4. Press **POWER / BATT** to save the setting.
 [SAVE] [End] appear and the power is turned off.

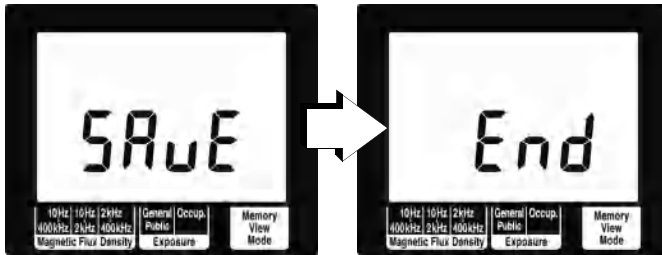

NOTE

RMS blinks while measuring with the slow function on.

4.3.5 Enable/disable the MEM. MODE key when Using MAX. HOLD or the Output Function

Use this function to turn on or off the **MEM. VIEW MODE** key when using MAX. HOLD or the output function.

NOTE

Displaying saved measurement data while using the output function causes output to turn off.

Follow the steps given below.

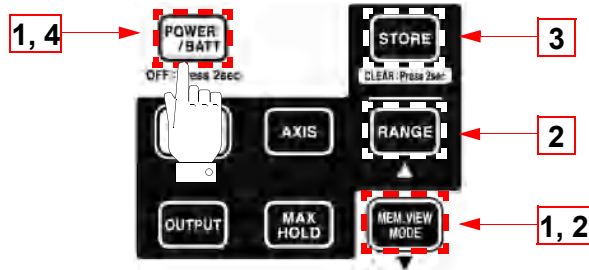

1. When the power is off, hold down **MEM. VIEW MODE** and press **POWER /BATT**.
2. Press **RANGE** (**▲**) or **MEM. VIEW MODE** (**▼**) to turn on [**MEM.M**].

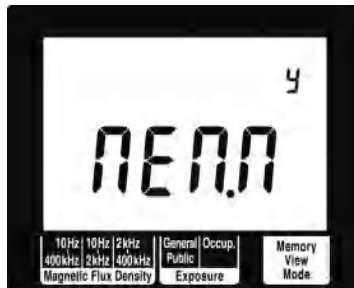

3. Press **STORE** and select **[y]** or **[n]**.

[y]	:	enables	MEM VIEW MODE	in MAX. HOLD mode and output modes.
[n]	:	disables	MEM VIEW MODE	in MAX. HOLD mode and output modes.

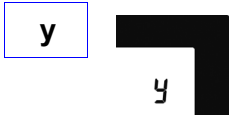

4. Press **POWER / BATT** to save the setting.
[SAVE] **[End]** appear and the power is turned off.

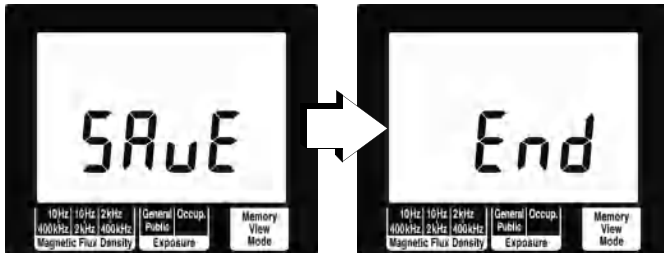

Using Application Software

5

5.1 Overview

The application software supplied with the FT3470-50 provides the following functions.

Functions	Functions in detail	See:
Graphic representation of measurement values	Analyzing measurement data on a PC	5.3 (P. 85)
Transfer recorded data to a PC		5.4 (P. 88)
Configure the FT3470-50 from a PC	Configuring the FT3470-50 from a PC	5.5 (P. 91)
View application software version	Checking version of application software	5.6 (P. 93)

The supplied PC driver and the application software must be installed on a PC to enable downloading data from the FT3470-50 tester.

[See : 5.2 "Installing" \(P.72\)](#)

Operating environment

Supported operating system	<ul style="list-style-type: none"> Windows XP, Windows Vista® (32 bit/64 bit), Windows 7 (32 bit/64 bit) The hardware environment comprising CPU, memory, display, etc. must conform to operating system recommendations.
Hard disk capacity	<ul style="list-style-type: none"> 10 MB or more free disk space
Interface	<ul style="list-style-type: none"> USB Ver. 1.1 or later One FT3470-50 unit can be connected at any one time

NOTE

USB hubs with a power consumption exceeding 100 mA must be self-power hubs.

CD configuration

Folder	Japanese English	Folder containing the application configuration file and a file for installing FT3470-50 USB driver
File	accuracy.dat	Accuracy file

NOTE

Select "small font" for the operating system since "large font" may cause irregularities in screen indications.

5.2 Installing

The major installation procedures are listed below.

1

Install the driver.

See : 5.2.1 "Installing the Driver" (P.72)

2

Install the PC software.

See : 5.2.2 "Installing Software" (P.82)

5.2.1 Installing the Driver



The driver installation procedures are described below.

! CAUTION

Do not connect and disconnect the USB cable during operations. Disconnecting the USB cable will prevent normal completion of the installation procedure.

NOTE

- Only one FT3470-50 tester can be connected to one PC.
- You may be informed that a new device has been detected also when a FT3470-50 tester with a different serial number is connected. Install the device driver according to the on-screen instructions.

Windows 7

1. Insert the supplied CD in the DVD/CD drive.
2. Open the folder [English] included on the CD, then execute driverSetup.msi. This will activate the installer and open the "HIOKI USB Single Driver" window.

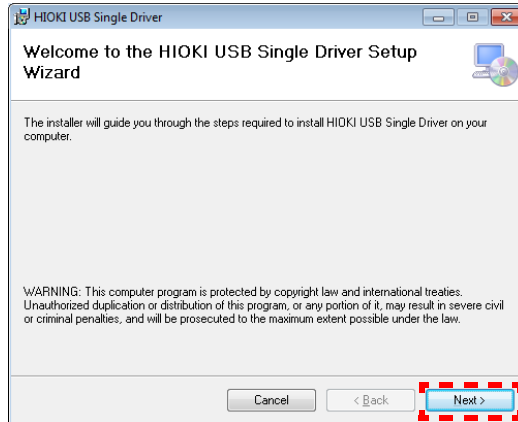

3. Click [Next].
4. Specify the installing destination folder and click [Next].

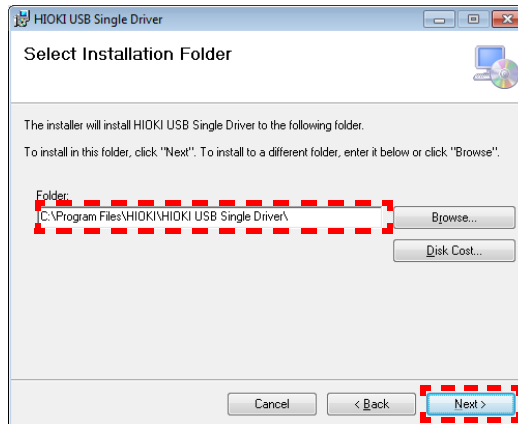

5. Click [Next].

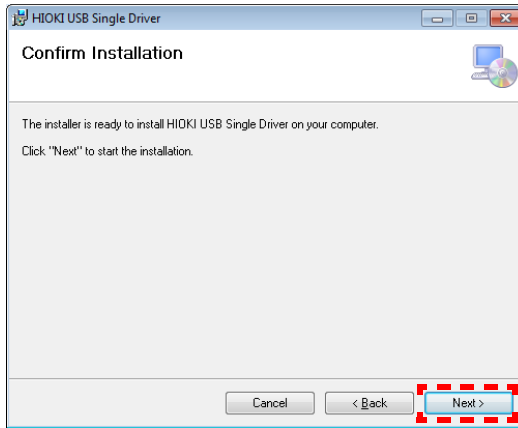

6. Click [Yes].

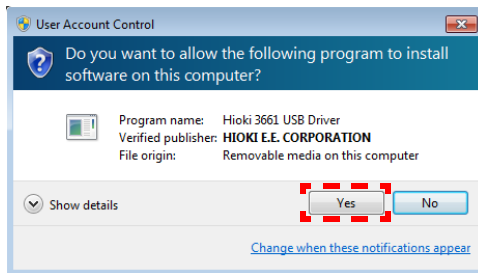

7. Click [Install].

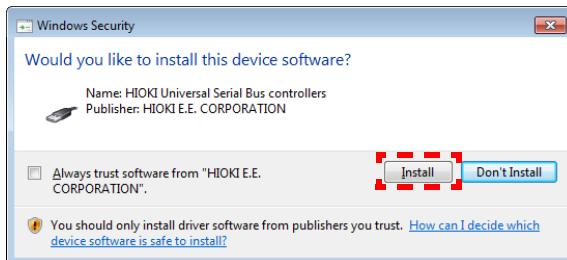

8. Click **[Close]**.

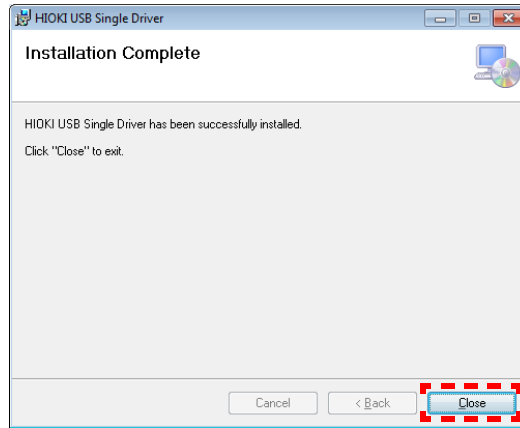

9. Remove the CD from the DVD/CD drive.

Windows Vista®

1. Insert the supplied CD in the DVD/CD drive.
2. Open the folder **[English]** included on the CD, then execute driverSetup.msi.
This will activate the installer and open the "HIOKI USB Single Driver" window.



3. Click **[Next]**.
4. Specify the installing destination folder and click **[Next]**.

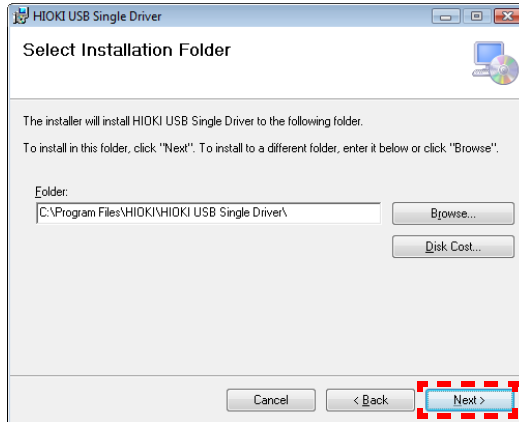

5. Click **[Next]**.

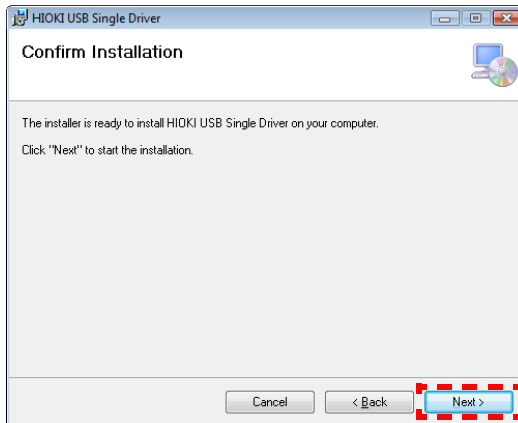

6. Click **[Continue]**.

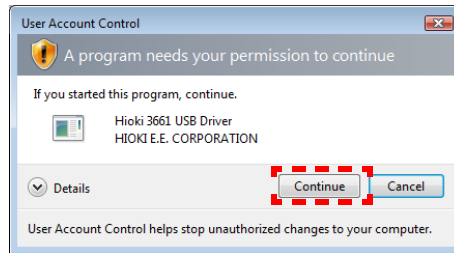

7. Click **[Install]**.

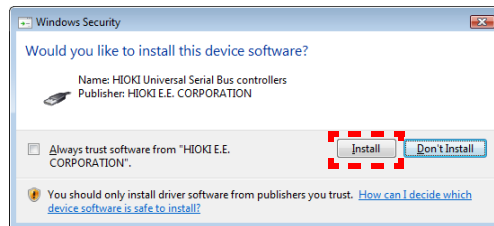

8. Click **[Close]**.

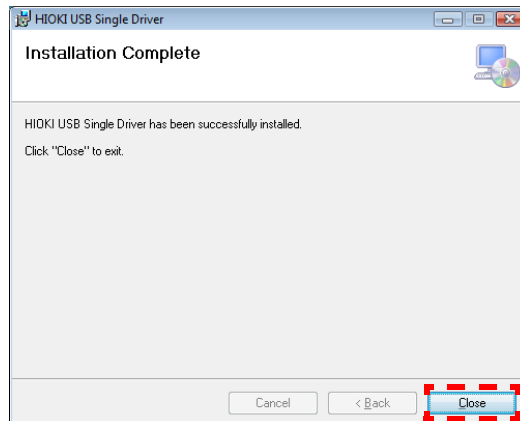

9. Remove the CD from the DVD/CD drive.

Windows XP

1. Insert the supplied CD in the DVD/CD drive.
2. Open the folder [English] included on the CD, then execute driverSetup.msi. This will activate the installer and open the "HIOKI USB Single Driver" window.

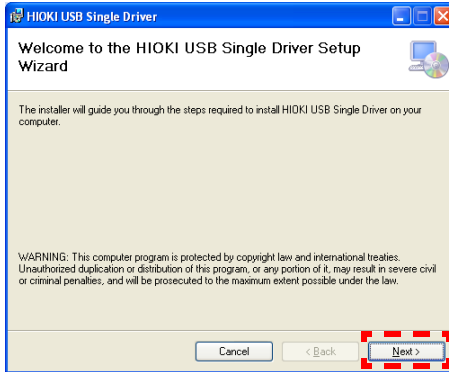

3. Click [Next].
4. Specify the installing destination folder and click [Next].

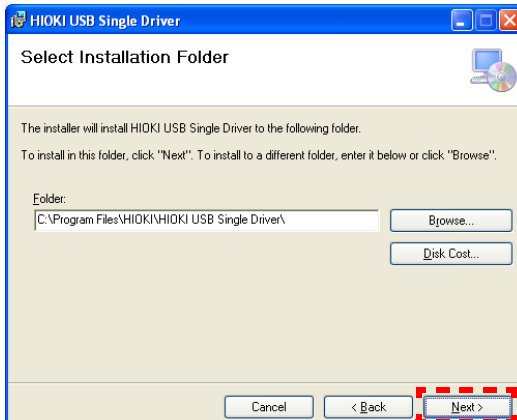

5. Click **[Next]**.

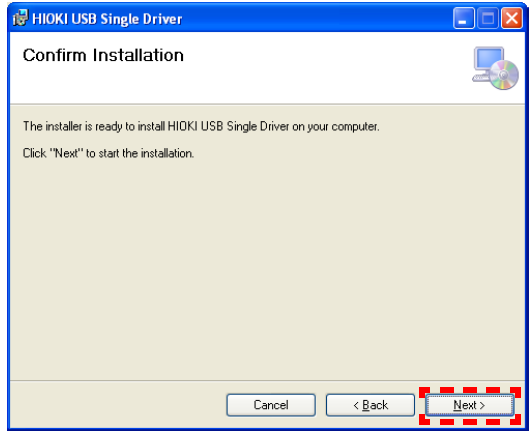

5

6. Click **[Continue Anyway]**.

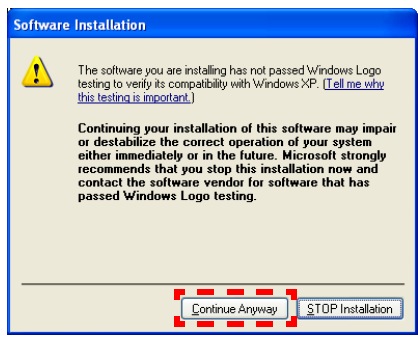

7. Click [**C**lose].

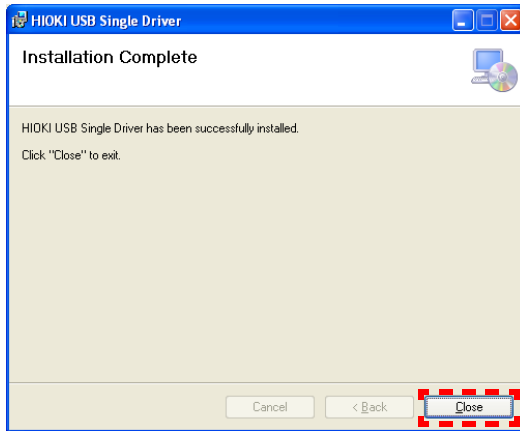

8. Remove the CD from the DVD/CD drive.
9. Turn on the tester.
10. Using the supplied USB cable, connect the tester to the PC.
11. When the FT3470-50 is connected to the PC for the first time, connection is automatically detected by the PC. The "Found New Hardware Wizard" appears.
12. Select "No, not this time" and click [**N**ext].

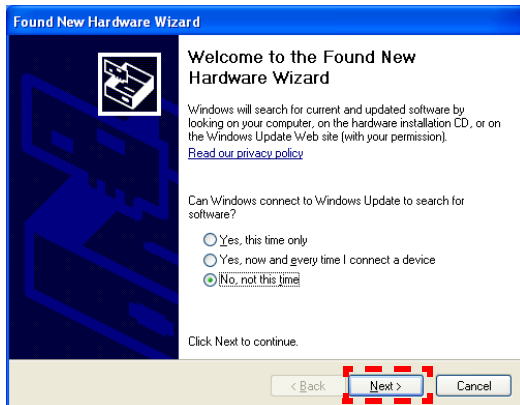

13. Select "Install the software automatically" and click [Next].

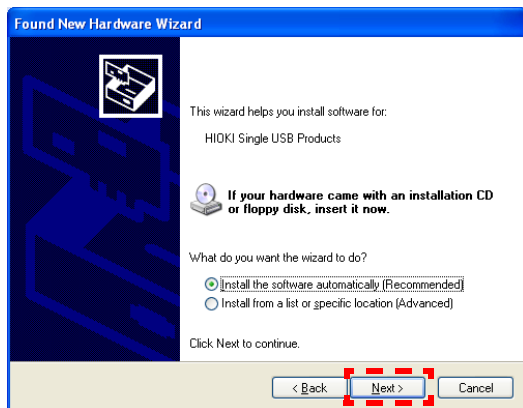

14. Click [Continue Anyway].



15. Click [Finish].



5.2.2 Installing Software

The software installation procedures are described below.

1. Close all currently active applications on the PC.
2. Insert the CD (PC application software) supplied with the instrument into the CD-ROM drive.
3. Open the folder [English] included on the CD, then execute Setup.exe.

This will activate the installer and open the "DATA VIEWER for FT3470 (EN)" window.

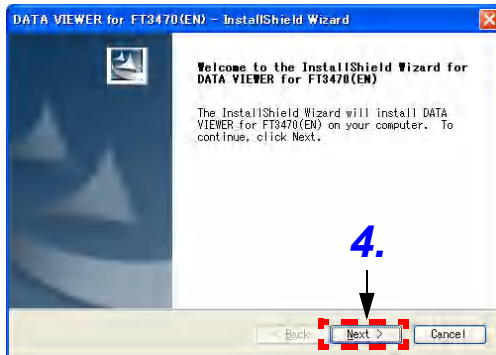

4. Click [Next].

5. Click **[Change]**, then specify the installing destination folder. Click **[Next]**.

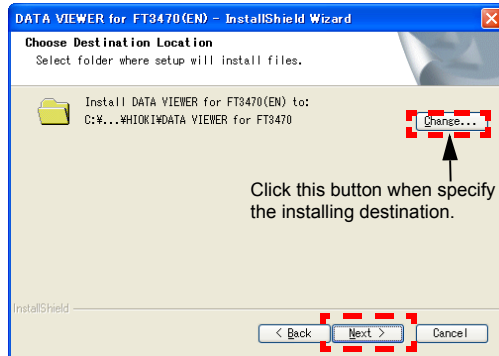

6. Click **[Install]**.

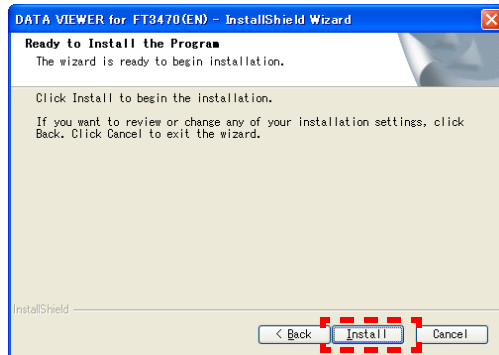

7. When installation ends, click **[Finish]** in the checking window.

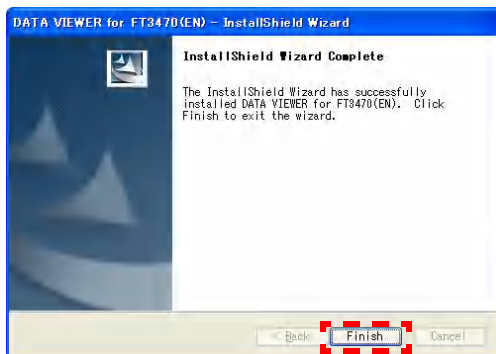

Installation is now complete.

Select [Program] - [HIOKI] - [DATA VIEWER for FT3470] - [DATA VIEWER for FT3470 (EN)] from the [Start] menu of Windows® to activate the application.

Uninstallation

1. Select [Setup] - [Control Panel] from the [Start] menu, then click [Add/Remove Programs].
2. Select "DATA VIEWER for FT3470 (EN)," then click [Remove] or [Change/Remove].
3. Uninstall the program by following the procedure appearing on the screen.

5.3 Graphic Representation of Measurement Values



Measurement values obtained using the FT3470-50 tester can be imported to a PC for graphic representation.

1. Turn on the FT3470-50 and select [**HIOKI**]-[**DATA VIEWER for FT3470**]-[**DATA VIEWER for FT3470 (EN)**] from the Start button on the PC.
2. Connect the tester to a PC using the supplied USB cable. (Push the cable plugs all the way in.)

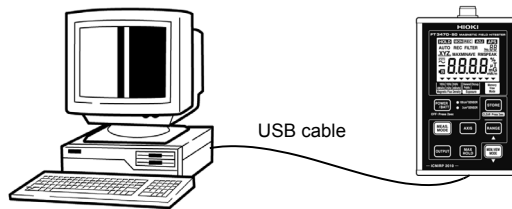

HOLD on the FT3470-50 lights and all key operations other than the **POWER / BATT** are disabled.

NOTE

- Only one FT3470-50 tester can be connected to a PC at one time.
- The effective value logger can obtain up to 32000 data.

3. Click the "Effective Value Logger" tab in the "HIOKI DATA VIEWER for FT3470" window to open the "Effective Value Logger" screen.

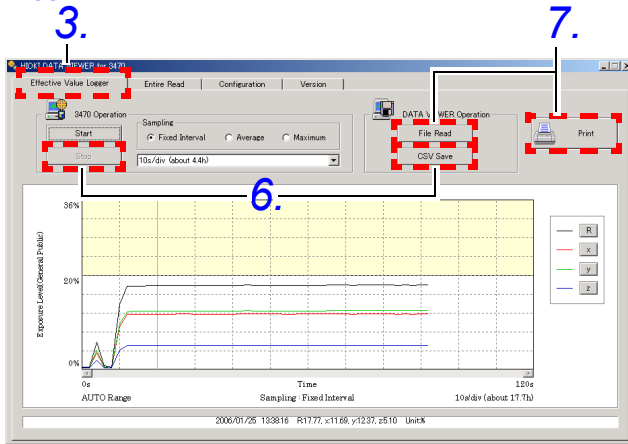

Menu item	Description
Fixed Interval	Samples at fixed intervals to obtain 20 points per division.
Average	Calculates the average of sampling data obtained in drawing 1 point. (Equation) $\hat{x} = \sqrt{\frac{1}{T} \int_{t-T}^t x^2 dt} = \sqrt{\frac{1}{N} \sum_{n=1}^N \hat{x}_n^2}$ $\hat{y} = \sqrt{\frac{1}{T} \int_{t-T}^t y^2 dt} = \sqrt{\frac{1}{N} \sum_{n=1}^N \hat{y}_n^2}$ $\hat{z} = \sqrt{\frac{1}{T} \int_{t-T}^t z^2 dt} = \sqrt{\frac{1}{N} \sum_{n=1}^N \hat{z}_n^2}$ $\hat{R} = \sqrt{\hat{x}^2 + \hat{y}^2 + \hat{z}^2}$
Maximum	Indicates data when resultant RMS value R is at its maximum among the sampling data obtained in drawing 1 point.
Drop-down list box for sampling interval	Selects sampling interval. When the slow function is set to ON, 1 s/div and 5 s/div are not available.
R/ x/ y/ z	Turn R, x, y and z data indication On and Off.
File Read	Represents saved data in graphic form and saves it as graph data.
CSV Save	Saves graph data.
Start	Starts measurements.
Stop	Stops measurements.
Print	Prints graphs

4. Set sampling method, sampling interval and start measurements.

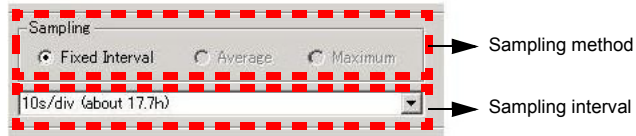

5. Click the mouse to move the vertical lines in the graph and to indicate the data for the corresponding time interval at the bottom of the screen.

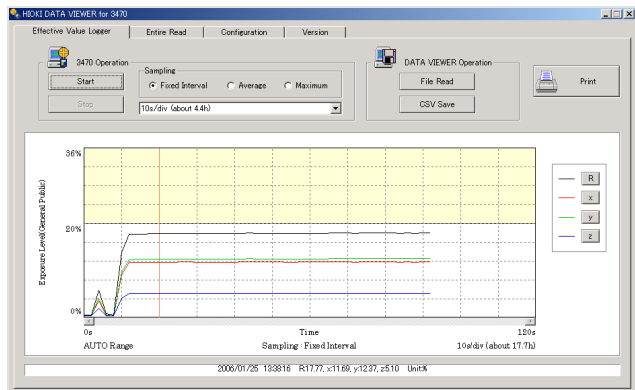

6. Click **[Stop]** to stop measuring. Then click **[CSV Save]** to save the graph data.
7. Click **[File Read]** to read out saved data. Or click **[Print]** to print the graph.
8. Disconnect the USB cable from the tester and the PC and turn off the tester.

5.4 Transferring Recorded Data to a PC



Use this function to transfer data from the FT3470-50 tester to a PC. The data can be saved in the CSV format on the PC.

1. Turn on the FT3470-50 and select [HIOKI]-[DATA VIEWER for FT3470]-[DATA VIEWER for FT3470 (EN)] from the Start button on the PC.
2. Connect the tester to a PC using the supplied USB cable. (Push the cable plugs all the way in.)

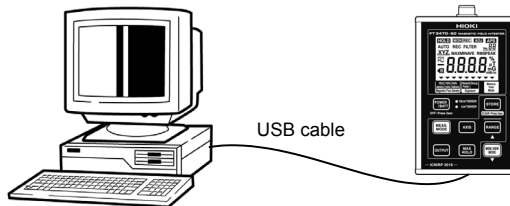

HOLD on the FT3470-50 lights and all key operations other than the  are disabled.

NOTE

- Only one FT3470-50 tester can be connected to a PC at one time.
- The prescribed accuracy range is not considered in R+Accuracy and R-Accuracy*.
*: R+Accuracy and R-Accuracy are the results of + and - accuracy calculations of resultant RMS values and indicates that R is within this range. These values may be used in the standard.
- Accuracy for the "**Entire Read**" tab is shown in the table below.

Measurement function	Accuracy
Magnetic flux density	$\pm 3.5\% \text{rdg.} \pm 0.5\% \text{f.s.}$
Exposure level	$\pm 5.0\% \text{rdg.} \pm 0.5\% \text{f.s.}$

3. Click the "Entire Read" tab in the "HIOKI DATA VIEWER for FT3470" window to open the "Entire Read" screen.

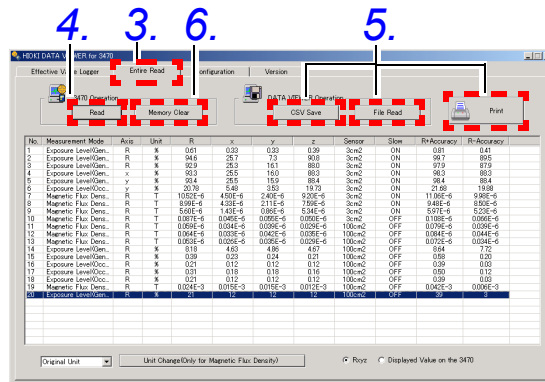

Screen item	Description
Read	Transfers data from the FT3470-50 tester to a PC.
Memory Clear	Deletes data recorded on the FT3470-50.
CSV Save	Saves displayed data.
File Read	Displays saved data.
Unit Change drop-down list box	Selects unit for magnetic flux density data.
Unit Change	Changes unit for indicated magnetic flux density data to unit selected in the Unit Change drop-down list box.
Rxyz / Displayed Value on the FT3470-50	Selects Rxyz or value displayed on the FT3470-50.
Print	Prints displayed data.

4. Click [Read] to transfer recorded data to a PC.

NOTE

Do not disconnect the USB cable during transfer or the transfer will not end normally.

5. Then click [**CSV Save**] to save the displayed data.

Click [**File Read**] to read out saved data. Or click [**Print**] to print the displayed data.

6. Use [**Memory Clear**] to delete recorded data on the FT3470-50 that is no longer needed.

7. Disconnect the USB cable from the tester and the PC and turn off the tester.

5.5 Configuring the FT3470-50



Use the instructions below to configure and store the settings that the FT3470-50 use when powered up.

1. Turn on the FT3470-50 and select [**HIOKI**]-[**DATA VIEWER for FT3470**]-[**DATA VIEWER for FT3470 (EN)**] from the Start button on the PC.
2. Connect the tester to a PC using the supplied USB cable. (Push the cable plugs all the way in.)

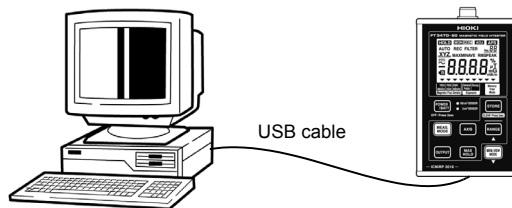

HOLD on the FT3470-50 lights and all key operations other than the  are disabled.

NOTE

Only one FT3470-50 tester can be connected to a PC at one time.

- Click the "Configuration" tab in the "HIOKI DATA VIEWER for FT3470" window to open the "Configuration" screen.

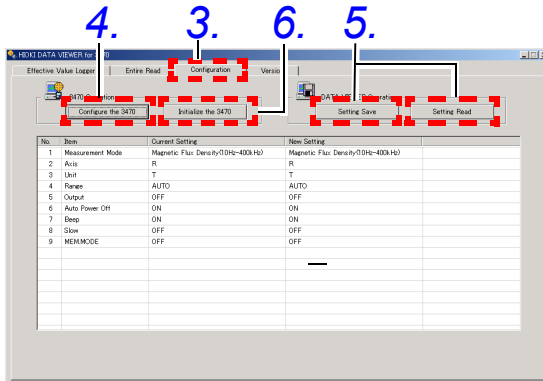

Screen item	Description
Configure the FT3470-50	Configures the FT3470-50.
Initialize the FT3470-50	Returns the FT3470-50 to its factory defaults.
Setting Save	Saves made settings.
Setting Read	Reads saved settings.

- Click [**Configure the FT3470**] to set up the FT3470-50 tester.
- Then click [**Setting Save**] to save the displayed data.

Click [**Setting Read**] to read out saved data.

NOTE

Be sure not to change the file extension as this will prevent normal reading of file data.

- Use [**Initialize the FT3470**] to return the FT3470-50 settings to their factory defaults.
- Disconnect the USB cable from the tester and the PC and turn off the tester.

5.6 Viewing Version Information



Use this function to view the version of the "HIOKI DATA VIEWER for FT3470".

1. Turn on the FT3470-50 and select [**HIOKI**]-[**DATA VIEWER for FT3470**]-[**DATA VIEWER for FT3470 (EN)**] from the Start button on the PC.
2. Connect the tester to a PC using the supplied USB cable. (Push the cable plugs all the way in.)

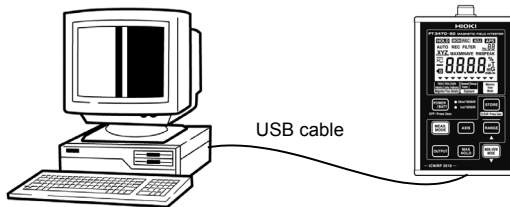

HOLD on the FT3470-50 lights and all key operations other than the **POWER / BATT** are disabled.

NOTE

Only one FT3470-50 tester can be connected to a PC at one time.

3. Click the "**Version**" tab in the "**HIOKI DATA VIEWER for FT3470**" window to open the "**Version**" screen.



4. Disconnect the USB cable from the tester and the PC and turn off the tester.

Advanced Measurements

6

6.1 Outputting Waveform and Resultant RMS Values



! WARNING

Do not simultaneously connect the USB and output terminals of the tester to external devices.

If the ground potential of the device connected to the USB terminal differ from that of the device connected to the output terminal, a short circuit current could flow via the FT3470-50 and damage the device connected to the USB terminal by fire.

When both terminals need to be used to connect, for example, a PC to the USB terminal and an oscilloscope to the output terminal, make sure that both devices are connected to ground or use a device (for example, a recorder) with insulated input terminals on the output terminal side.

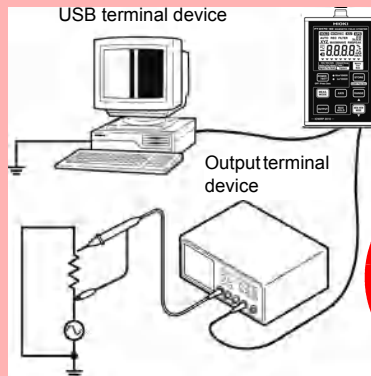

Never connect the tester as shown in the figure.

CAUTION

- Do not short circuit the output terminals or apply a voltage as this could damage them.
- When connecting the tester to an insulation BNC, connect the 9759 Output Cable to a 9489 Extension Cable before connecting it to an insulation BNC. The 9759 Output Cable is a metal BNC that could damage an insulation BNC if connected to it directly. The 9489 Extension Cable should function as a safe insulation BNC. These are consumables that should be replaced with new ones when damaged.

You can observe waveforms and resultant RMS values by connecting the instrument to an oscilloscope or recorder with the 9759 Output Cable.

Waveform output	: enables measurement of magnetic field waveforms when the tester is connected to an oscilloscope or recorder.
Resultant RMS value output	: permits recording of resultant values on a recorder or logger, which is convenient for long-term measurements.

NOTE

- The output may become unstable during switching of measurement modes or ranges.
- The extremely high sensitivity of output during measurements in low ranges (r0) makes noise inherent to the device more noticeable. Select an appropriate range on an oscilloscope before viewing the waveform output.
(When using the magnetic flux density function's minimum range (r0), a 0.1 mT waveform corresponds to 10 mV of output. Then set the oscilloscope to a range appropriate for 50 mV/div measurements)
- During the output of waveform and resultant RMS values, the auto range is canceled, and the range is fixed in the selected range.
- Output of waveform and resultant RMS values cancels the auto range and the tester is locked in the selected range.
- Use a high input impedance connection to connect the tester to an oscilloscope.
- Displaying saved measurement data while using the output function causes output to turn off.

Output waveforms and resultant RMS values according to the steps below.

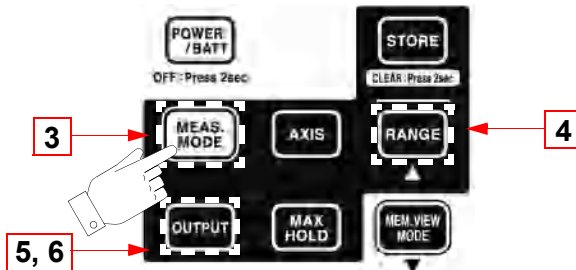

6.1 Outputting Waveform and Resultant RMS Values

1. Push the 9759 Output Cable all the way into the FT3470-50 output terminal.

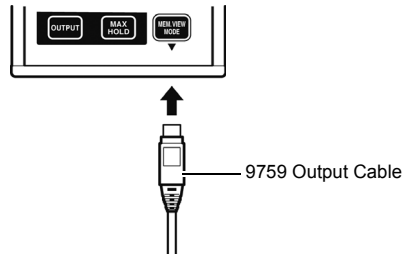

2. Connect the output cable plug in the oscilloscope, recorder, or etc. connector.
3. Press  and select a measurement function/mode.

Magnetic flux density measurement function 10Hz-400kHz mode is selected in this example.

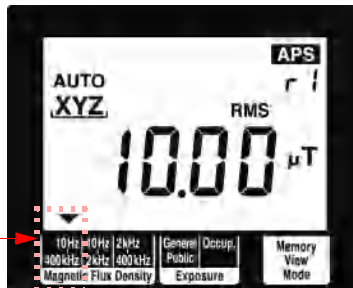

4. Press  to confirm measurement range selection.

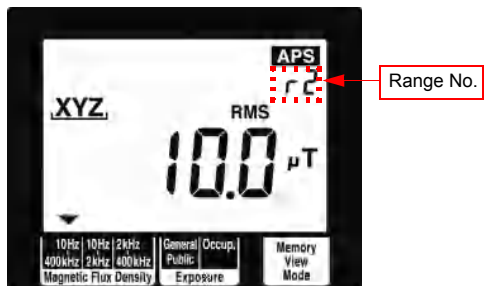

Measurement function	Range	Output rate	
		Waveform output (MON)	Level value (REC)
Magnetic flux density	r0	AC 100 mV/ μT	DC 100 mV/ μT
	r1	AC 10 mV/ μT	DC 10 mV/ μT
	r2	AC 1 mV/ μT	DC 1 mV/ μT
	r3	AC 100 mV/ mT	DC 100 mV/ mT
Exposure level	r0	-	DC 10 mV/%
	r1	-	DC 1 mV/%

The waveform output (MON) cannot be configured in exposure level function.

5. Pressing **OUTPUT** enables output and automatically cancels auto power off (**APS** goes off)

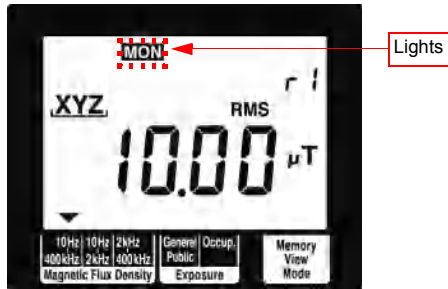

(During waveform output)

6. Each press of the **OUTPUT**, changes the display as follows: Output OFF → Waveform (**MON** lights) → Resultant RMS value (**REC** lights) → OFF

(The waveform output (**MON** lights), only for magnetic flux density function)
(resultant RMS values are output via the X-axis.)

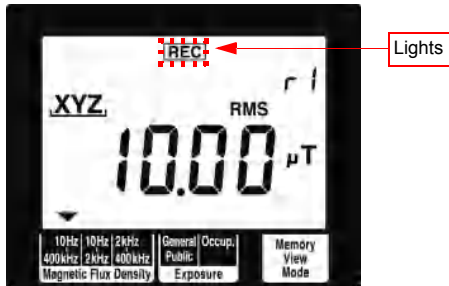

(During resultant RMS value output)

This completes output of waveforms and resultant RMS values.



Specifications

7

7.1 FT3470-50 Magnetic Field Tester

The 100 cm² or 3 cm² Magnetic Field Sensor is attached to the FT3470-50.

7.1.1 Basic Specifications

1. Measurement item

Magnetic flux density 10 Hz to 400 kHz / 10 Hz to 2 kHz / 2 kHz to 400 kHz

Exposure level General Public/Occupational

Measured axes X, Y, Z

Measurement method True RMS

Range switching auto/manual

2. Indication

Display LCD display

Indicated axes X, Y, Z, R (resultant RMS value)

Maximum display value 2000 count for single axis and 3464 count for resultant RMS value R

Magnetic flux density units T, G, A/m

Exposure level unit %

Auto Range indication **AUTO**

RMS value indication **RMS**

Maximum value hold indication **MAX**

Output function indication **MON REC**

Auto power off enabled indication **APS**

Battery low warning  icon lights (measurement accuracy is not guaranteed when this icon is on)

Display update rate	Approx. 250 ms (slow function off) Approx. 2 s (slow function on)
---------------------	--

7.1.2 Measurement Accuracy

1. Guaranteed accuracy specifications

Guaranteed accuracy condition Defined for the FT3470-50 when used with a 100 cm² or 3 cm² Magnetic Field Sensor with the same phase number.

Accuracy guarantee for temperature and humidity 23°C±5°C 80% RH or less (no condensation)

Guaranteed accuracy period 1 year

2. Magnetic flux density

Accuracy specification

Magnetic Field Sensor	Measured axes	Range	Measurement mode	Effective measuring range	Accuracy
100 cm ² Magnetic Field Sensor	X, Y, Z	r0	10 Hz to 400 kHz, 10 Hz to 2 kHz, 2 kHz to 400 kHz	0.050 to 2.000 μT	±3.5%rdg. ±0.5%f.s.
		r1		0.50 to 20.00 μT	
		r2		5.0 to 200.0 μT	
		r3		0.050 to 2.000 mT	
	R	r0	10 Hz to 400 kHz, 10 Hz to 2 kHz, 2 kHz to 400 kHz	0.100 to 3.464 μT	±3.5%rdg. ±0.5%f.s.
		r1		1.00 to 34.64 μT	
		r2		10.0 to 346.4 μT	
		r3		0.100 to 3.464 mT	
3 cm ² Magnetic Field Sensor	X, Y, Z	r0	10 Hz to 400 kHz, 10 Hz to 2 kHz, 2 kHz to 400 kHz	0.200 to 2.000 μT	±3.5%rdg. ±0.5%f.s.
				0.050 to 2.000 μT	
		r1		0.50 to 20.00 μT	
		r2		5.0 to 200.0 μT	
	R	r0		0.400 to 3.464 μT	±3.5%rdg. ±0.5%f.s.
				0.100 to 3.464 μT	
		r1		1.00 to 34.64 μT	
		r2		10.0 to 346.4 μT	
r3	0.100 to 3.464 mT				

Valid measurement frequency range

Measurement function	Measurement mode	Valid measurement frequency range
Magnetic flux density	10 Hz to 400 kHz	50 Hz to 100 kHz
	10 Hz to 2 kHz	50 Hz to 1 kHz
	2 kHz to 400 kHz	5 kHz to 100 kHz

3. Exposure level (General Public, Occup.)

Accuracy specifications

Measured axes	Range	Effective measuring range	Accuracy
X, Y, Z	r0	0.50 to 20.00%	Smoothed edges 50 Hz to 1 kHz ±3.5%rdg.±0.5%f.s. Smoothed edges 1 kHz to 100 kHz ±5.0%rdg.±0.5%f.s.
	r1	05.0 to 200.0%	
R	r0	1.00 to 34.64%	
	r1	10.0 to 346.4%	

Smoothed edges

Exposure level is an IEC/EN62233-defined measurement technique applying time domain evaluation to magnetic flux density as described by the ICNIRP 2010 guidelines.

It differs by a maximum of 3 dB from the ICNIRP 2010 corner frequency.

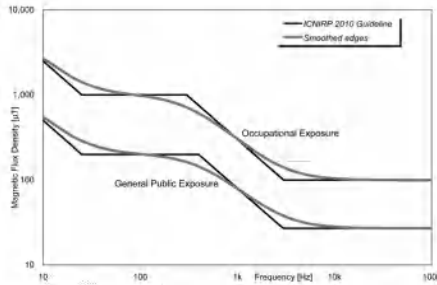

4. Characteristic

Crest factor 3 or less (But exposure level (occupational) for r1 and r2 is 1.45 or less.)

Effect of exposure to power-frequency fields In a 20 kV/m, 60 Hz field at resultant RMS value R

Magnetic field sensor	Influence of resultant RMS value R	
	Magnetic flux density (10 Hz to 400 kHz)	Exposure level (General Public)
100 cm ² Magnetic Field Sensor	0.02 µT or less	0.1% or less
3 cm ² Magnetic Field Sensor	0.15 µT or less	0.6% or less

Effect of tester on magnetic field With magnetic sensor directly connected to the tester

Magnetic field sensor	Influence of resultant RMS value R
100 cm ² Magnetic Field Sensor	±1.5%rdg. or less
3 cm ² Magnetic Field Sensor	±2.5%rdg. or less

Noise level (reference value)

Magnetic field sensor	Measurement function/mode	Resultant RMS value R
100 cm ² Magnetic Field Sensor	Magnetic flux density (10 Hz to 400 kHz)	0.050 µT
3 cm ² Magnetic Field Sensor		0.150 µT

RMS integral time (reference value) Approx. 120 ms (slow function off)
Approx. 1 s (slow function on)



7.1.3 Output Function

Supporting function Magnetic flux density (T), Exposure level (%)

Output type MON : 3-axis waveform output
 REC : Resultant RMS level output (output via the X-axis.)
 Exposure level output (output via the X-axis.)

Output rate 0.1 mV/display value count
 An output rate based on the magnetic flux density unit T is used, even if the magnetic flux density unit is G or A/m.

Measurement function/	Range	Output rate	
		Waveform output (MON)	Level value (REC)
Magnetic flux density	r0	AC 100 mV/ μ T	DC 100 mV/ μ T
	r1	AC 10 mV/ μ T	DC 10 mV/ μ T
	r2	AC 1 mV/ μ T	DC 1 mV/ μ T
	r3	AC 100 mV/mT	DC 100 mV/mT
Exposure level	r0	-	DC 10 mV/%
	r1	-	DC 1 mV/%

Output accuracy

Type	Measurement function	Measurement Mode	Output accuracy	Effective frequency range
REC	Magnetic flux density	10 Hz-400 kHz	$\pm 3.5\% \text{rdg.} \pm 3 \text{ mV}$	50 Hz to 100 kHz
		10 Hz-2 kHz		50 Hz to 1 kHz
		2 kHz-400 kHz		5 kHz to 100 kHz
	Exposure level	General Public/ Occupational	$\pm 3.5\% \text{rdg.} \pm 3 \text{ mV}$ $\pm 5.0\% \text{rdg.} \pm 3 \text{ mV}$	50 Hz to 1 kHz 1 kHz to 100 kHz
MON	Magnetic flux density	10 Hz-400 kHz	$\pm 3.5\% \text{rdg.} \pm 10 \text{ mV}$	50 Hz to 100 kHz
		10 Hz-2 kHz		50 Hz to 1 kHz
		2 kHz-400 kHz		5 kHz to 100 kHz

Output accuracy (MON) is defined under the condition that the input is sine wave with no distortion.

7.1.4 Functional Specifications

Magnetic flux density unit switching	G (1 T = 10 ⁴ G) A/m (1 T = 4π·10 ⁻⁷ A/m, assuming a magnetic permeability of 4π·10 ⁻⁷ H/m for air) Accuracy is defined in terms of the magnetic flux density unit T.					
	Measured axes	unit	Maximum display for range			
			r0	r1	r2	r3
	X, Y, Z	T	2.000 μT	20.00 μT	200.0 μT	2.000 mT
		G	20.00 mG	200.0 mG	2.000 G	20.00 G
		A/m	1.592 A/m	15.92 A/m	159.2 A/m	1592 A/m
	R	T	3.464 μT	34.64 μT	346.4 μT	3.464 mT
G		34.64 mG	346.4 mG	3.464 G	34.64 G	
A/m		2.757 A/m	27.57 A/m	275.7 A/m	2757 A/m	
Slow function	Can be turned on and off (default: off). Functionality for applying the 1 s RMS integration time required by IEC/EN62233					
Holds the maximum value	Holds the maximum value of the resultant RMS value R and the values of each axis.					
Memory function	Up to 99 measured value data points can be saved. 1 data point: Resultant RMS value R and the corresponding measured values for each axis					
Auto power off	10.5 min after last operation, buzzer warning before shutdown/wait period can be extended/function can be cancelled after activation					
Buzzer sound	Can be turned on/off (default : on)					

7.1.5 General Specifications

Product warranty period	3 years
Interface	USB 1.1
Temperature characteristics	0.1 x accuracy specification/°C at 0 to 40°C
Place of use	Indoors, up to an altitude of 2000 m
Storage temperature and humidity	-10°C to 50°C, 80% RH or less (no condensation)
Operating temperature and humidity	0°C to 40°C, 80% RH or less (no condensation)

Power supply	Rated power supply voltage: 100 VAC to 240 VAC, Rated power supply frequency: 50 Hz/ 60 Hz (Voltage fluctuations of $\pm 10\%$ from the rated supply voltage are taken into account.) Four LR6 alkaline battery 1.5 V or 9445-02 AC Adapter	
Continuous operating time	Approx. 10 hours (with sensor connected, continuous, low load operation)	
Maximum rated power	1.0 VA (AC adapter), 0.8 VA (Battery)	
External dimensions	Approx 100 × 150 × 42 mm (3.94"W × 5.91"H × 1.65"D) (not including protrusions)	
Weight	Approx 830 g (29.3 oz) (batteries included)	
Standards Applying	Safety	EN61010 Pollution degree 2
	EMC	EN61326
Magnetic Field Tester composition	FT3470-50 Magnetic Field Tester	1
	100 cm ² Magnetic Field Sensor (3-axis)	1
	3 cm ² Magnetic Field Sensor (3-axis)	1
Accessories	Instruction manual	1
	CD (PC application software)	1
	USB cable	1
	LR6 alkaline battery	4
	9758 Extension Cable	1
	9759 Output Cable	1
	9445-02 AC Adapter	1
	Carrying Case	1
Options	9445-02 AC Adapter	
	9758 Extension Cable	
	9759 Output Cable	

7.1.6 Application Software

Name	DATA VIEWER for the FT3470
Connected instrument	FT3470-50 Magnetic Field Tester
Connection method	USB Ver.1.1 or later (Only one FT3470-50 tester can be connected to a PC at one time)
Content recognition	Serial number
Computer	PC-AT compatible machines (Processor operating at 1 GHz)
Supported operating system	Windows XP, Windows Vista® (32 bit/64 bit), Windows 7 (32 bit/64 bit)
Language	English or Japanese
Memory	at least 512 MB (recommended)
HDD	Required hard disk space: at least 30 MB

Display	1024×600 dots or higher
Display tab	Effective value logger, Entire read, Configuration, Version information
Maximum number of data handled	32000 data (Effective value logger), 99 data (Entire read)
Recording method	CSV format (Effective value logger), (Entire read) SET format (Configuration)

7.1.7 Equations and Functions

Equations

Function	Item	Symbol	Equation	
			Continuous	Discrete
Waveform output	Instantaneous value for each axis at time t	$x(t)$	-	-
		$y(t)$	-	-
		$z(t)$	-	-
-	Resultant value at time t	$R(t)$	$\sqrt{\{x(t)\}^2 + \{y(t)\}^2 + \{z(t)\}^2}$	-
LCD display (effective value logger)	RMS value for each axis at time t (Integral time = T, interval [t - T, t])	$\hat{x}(t)$	$\sqrt{\frac{1}{T} \int_{t-T}^t \{x(t)\}^2 dt}$	Where RMS value per Δt interval is \hat{x}_n ($1 \leq n \leq N, N\Delta t = T$), $\sqrt{\frac{1}{N} \sum_{n=1}^N \hat{x}_n^2}$
		$\hat{y}(t)$	$\sqrt{\frac{1}{T} \int_{t-T}^t \{y(t)\}^2 dt}$	Where RMS value per Δt interval is \hat{y}_n ($1 \leq n \leq N, N\Delta t = T$), $\sqrt{\frac{1}{N} \sum_{n=1}^N \hat{y}_n^2}$
		$\hat{z}(t)$	$\sqrt{\frac{1}{T} \int_{t-T}^t \{z(t)\}^2 dt}$	Where RMS value per Δt interval is \hat{z}_n ($1 \leq n \leq N, N\Delta t = T$), $\sqrt{\frac{1}{N} \sum_{n=1}^N \hat{z}_n^2}$
LCD display resultant RMS output (effective value logger)	Resultant RMS value (Integral time = T, interval [t - T, t])	$\hat{R}(t)$	$\sqrt{\{\hat{x}(t)\}^2 + \{\hat{y}(t)\}^2 + \{\hat{z}(t)\}^2}$	$\sqrt{\{\hat{x}(t)\}^2 + \{\hat{y}(t)\}^2 + \{\hat{z}(t)\}^2}$

- x , y and z in the table can be used to represent both magnetic flux density and exposure values.

7.1 FT3470-50 Magnetic Field Tester

- $1 \text{ G} = 1 \times 10^{-4} \text{ T}$, $1 \text{ A/m} = 4\pi \times 10^{-7} \text{ T}$ (magnetic permeability of air: $4\pi \times 10^{-7} \text{ H/m}$)
- Actual RMS values are calculated using a discrete algorithm.

Example of characteristics when tester is used with a sensor (magnetic flux density mode)

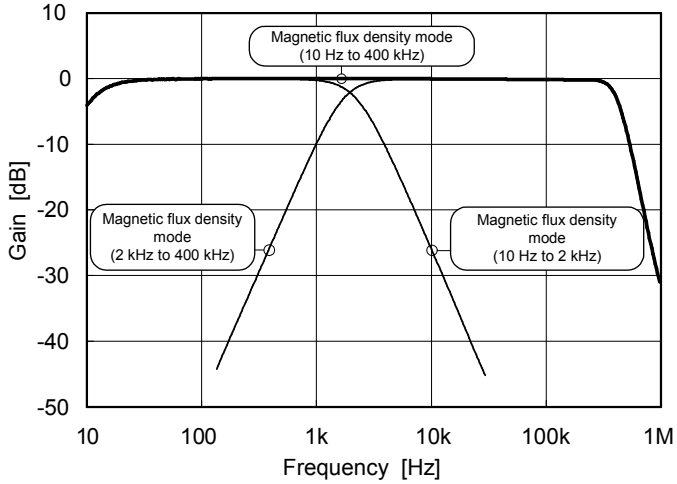

7.2 100 cm² Magnetic Field Sensor

Specifications

Accuracy at 23°C±5°C, 80% RH or less (no condensation)

Sensor cross-sectional area	100 cm ²	
Rated magnetic flux density	2 mT at a single axis (There is a derating characteristics dependent on frequency)	
Frequency characteristics	10 Hz to 400 kHz	
Measured axes	X, Y, Z	
Place of use	Indoors, up to an altitude of 2000 m	
Storage temperature and humidity	-10°C to 50°C, 80% RH or less (no condensation)	
Operating temperature and humidity	0°C to 40°C, 80% RH or less (no condensation)	
Period of guaranteed accuracy	1 year	
External dimensions	Approx. $\phi 122 \times 295$ (L) mm	
Weight	Approx. 210 g (7.4 oz)	
Application Standard	Safety	EN61010 Pollution degree 2
	EMC	EN61326

Frequency-dependent derating characteristics

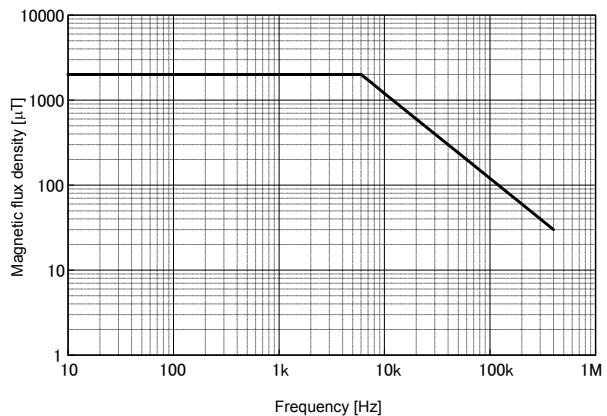

7.3 3 cm² Magnetic Field Sensor

Specifications

Accuracy at 23°C±5°C, 80% RH or less (no condensation)

Sensor cross-sectional area	3 cm ²
Rated magnetic flux density	2 mT at a single axis (There is a derating characteristics dependent on frequency)
Frequency characteristics	10 Hz to 400 kHz
Measured axes	X, Y, Z
Place of use	Indoors, up to an altitude of 2000 m
Storage temperature and humidity	-10°C to 50°C, 80% RH or less (no condensation)
Operating temperature and humidity	0°C to 40°C, 80% RH or less (no condensation)
Period of guaranteed accuracy	1 year
External dimensions	Approx. $\phi 27 \times 165$ (L) mm
Weight	Approx. 95 g (3.4 oz)
Application Standard	Safety EN61010 Pollution degree 2 EMC EN61326

Frequency-dependent derating characteristics

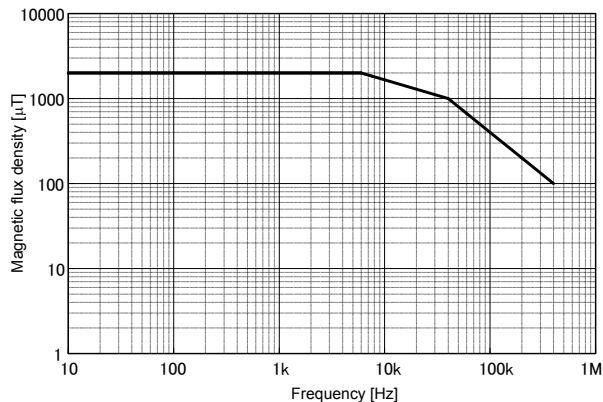

Maintenance and Service

8

8.1 Troubleshooting

If damage is suspected, check the "Before returning for repair" section before contacting your dealer or Hioki representative.

◆ Before returning for repair

Symptom	Check	Remedy
Tester does not go on.	<ul style="list-style-type: none"> • Check whether batteries have been inserted. • Check if battery power is low. • Check whether batteries are properly inserted. 	<ul style="list-style-type: none"> • Replace batteries with new ones. • Insert batteries properly.
Power turns off during use*		
B goes on. Power turns off soon after B goes on	-	Replace batteries with new ones.

*: When auto power off is on (**APS** lights), the tester will shut down 10 minutes after the last key was pressed

[See : 4.3.1 "Setting Auto Power Off \(Saving Battery Power\)" \(P.61\)](#)

When sending the instrument for repair, remove the batteries and pack carefully to prevent damage in transit. Include cushioning material so the instrument cannot move within the package. Be sure to include details of the problem. Hioki cannot be responsible for damage that occurs during shipment.

8.2 Error Indication

If any of error indications E.001 to E.005 appear on the display, the tester requires repair and should be returned to the dealer or local service station.

Error number	Description	Remedy
E.001	Microprocessor ROM checksum error	Requires repair.
E.002	Microprocessor RAM R/W error	
E.003	Memory checksum error	
E.004	Model name error	
E.005	Memory R/W error	

8.3 Version Display

In order to display the version of the FT3470-50, hold down  while powering up. The version will be displayed after the model name (3470).

8.4 Cleaning

To clean the instrument, wipe it gently with a soft cloth moistened with water or mild detergent. Never use solvents such as benzene, alcohol, acetone, ether, ketones, thinners or gasoline, as they can deform and discolor the case.

8.5 Service

Calibrations

- The calibration period varies depending on the status of the instrument or installation environment. We recommend that the calibration period be determined in accordance with the status of the instrument or installation environment. Please contact your Hioki distributor to have your instrument periodically calibrated.
- Since the tester must be calibrated together with the magnetic field sensor, send in both the tester and the magnetic field sensor when re-calibration is required.
- Since the tester must be calibrated together with the sensor, the tester must be returned when a magnetic field sensor requires repair or when other sensors are purchased to enable calibration with the repaired (or new) sensor.

Appendix

Appendix 1 ICNIRP Guideline (Basic Restrictions)

The exposure levels set for this tester are based on the ICNIRP (International Commission on Non-Ionizing Radiation Protection) Guidelines.

Basic restrictions apply to current density, SAR and power density. Threshold values have been set on the levels of these physical quantities that affect human health (for example, headaches). Occupational exposure level is 1/10 and general public exposure level is 1/50 of this threshold value. (See figure below.)

The ICNIRP Guidelines provide reference levels - for assessing the basic restrictions - that state the magnetic field and electric field levels when the coupling of the human body, magnetic field and electric field are at maximum (coupling factor 1).

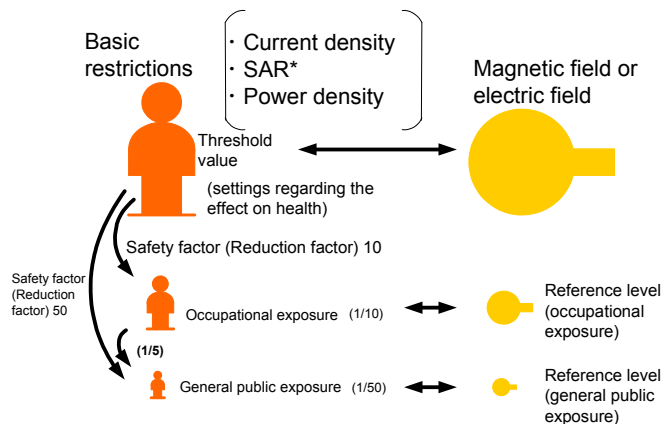

*: Specific energy absorption rate

As can be inferred from the above, there is a margin, a safety factor (reduction factor) between the exposure level measured by this tester and the threshold values in the basic restrictions. Thus an exposure level of 100% measured by this tester does not mean to affect the human body.

Appendix 2 Coupling Factor in the ICNIRP Guidelines

The degree of coupling (coupling factor) of the human body and a magnetic field changes the effect on the human body. Coupling factor a is $0 \leq a \leq 1$, where 0 is no coupling and 1 is maximum coupling. The greater the coupling factor the greater the effect the magnetic field has on the human body. (See figure below.)

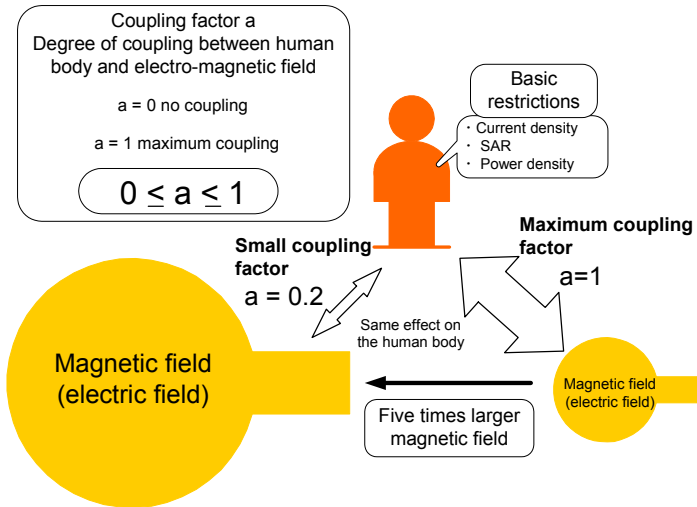

The ICNIRP reference level represents a coupling factor of 1.

Consequently, although the tester tells us the ratio of a measurement to the ICNIRP reference level, it cannot measure the coupling factor and therefore does not indicate the direct effect on the human body.

Warranty Certificate

HIOKI

Model	Serial number	Warranty period Three (3) years from date of purchase (___ / ___)
-------	---------------	--

Customer name: _____

Customer address: _____

Important

- Please retain this warranty certificate. Duplicates cannot be reissued.
- Complete the certificate with the model number, serial number, and date of purchase, along with your name and address. The personal information you provide on this form will only be used to provide repair service and information about Hioki products and services.

This document certifies that the product has been inspected and verified to conform to Hioki's standards.

Please contact the place of purchase in the event of a malfunction and provide this document, in which case Hioki will repair or replace the product subject to the warranty terms described below.

Warranty terms

1. The product is guaranteed to operate properly during the warranty period (three (3) years from the date of purchase). If the date of purchase is unknown, the warranty period is defined as three (3) years from the date (month and year) of manufacture (as indicated by the first four digits of the serial number in YYMM format).
2. If the product came with an AC adapter, the adapter is warranted for one (1) year from the date of purchase.
3. The accuracy of measured values and other data generated by the product is guaranteed as described in the product specifications.
4. In the event that the product or AC adapter malfunctions during its respective warranty period due to a defect of workmanship or materials, Hioki will repair or replace the product or AC adapter free of charge.
5. The following malfunctions and issues are not covered by the warranty and as such are not subject to free repair or replacement:
 - 1. Malfunctions or damage of consumables, parts with a defined service life, etc.
 - 2. Malfunctions or damage of connectors, cables, etc.
 - 3. Malfunctions or damage caused by shipment, dropping, relocation, etc., after purchase of the product
 - 4. Malfunctions or damage caused by inappropriate handling that violates information found in the instruction manual or on precautionary labeling on the product itself
 - 5. Malfunctions or damage caused by a failure to perform maintenance or inspections as required by law or recommended in the instruction manual
 - 6. Malfunctions or damage caused by fire, storms or flooding, earthquakes, lightning, power anomalies (involving voltage, frequency, etc.), war or unrest, contamination with radiation, or other acts of God
 - 7. Damage that is limited to the product's appearance (cosmetic blemishes, deformation of enclosure shape, fading of color, etc.)
 - 8. Other malfunctions or damage for which Hioki is not responsible
6. The warranty will be considered invalidated in the following circumstances, in which case Hioki will be unable to perform service such as repair or calibration:
 - 1. If the product has been repaired or modified by a company, entity, or individual other than Hioki
 - 2. If the product has been embedded in another piece of equipment for use in a special application (aerospace, nuclear power, medical use, vehicle control, etc.) without Hioki's having received prior notice
7. If you experience a loss caused by use of the product and Hioki determines that it is responsible for the underlying issue, Hioki will provide compensation in an amount not to exceed the purchase price, with the following exceptions:
 - 1. Secondary damage arising from damage to a measured device or component that was caused by use of the product
 - 2. Damage arising from measurement results provided by the product
 - 3. Damage to a device other than the product that was sustained when connecting the device to the product (including via network connections)
8. Hioki reserves the right to decline to perform repair, calibration, or other service for products for which a certain amount of time has passed since their manufacture, products whose parts have been discontinued, and products that cannot be repaired due to unforeseen circumstances.

HIOKI E.E. CORPORATION

<http://www.hioki.com>

18-07 EN-3

HIOKI

<http://www.hioki.com>



**Our regional
contact
information**

HEADQUARTERS

81 Koizumi, Ueda, Nagano 386-1192 Japan

HIOKI USA CORPORATION

<http://www.hiokiusa.com/> hioki@hiokiusa.com

HIOKI (Shanghai) SALES & TRADING CO., LTD.

<http://www.hioki.cn/> info@hioki.com.cn

HIOKI SINGAPORE PTE.LTD.

www.hioki.com.sg/ info-sg@hioki.com.sg
info-indo@hioki.com.sg (Indonesia)
info-thai@hioki.com.sg (Thailand)
info-vn@hioki.com.sg (Vietnam)

HIOKI KOREA CO., LTD.

<http://www.hiokikorea.com/> info-kr@hioki.co.jp

HIOKI EUROPE GmbH

<http://www.hioki.com/> hioki@hioki.eu

Taiwan Representative Office

<http://www.hioki.com/> info-tw@hioki.com.tw

MEA Representative Office

<http://www.hioki.com/> hioki@hiokimea.ae

1804EN

Edited and published by HIOKI E.E. CORPORATION

Printed in Japan

- CE declarations of conformity can be downloaded from our website.
- Contents subject to change without notice.
- This document contains copyrighted content.
- It is prohibited to copy, reproduce, or modify the content of this document without permission.
- Company names, product names, etc. mentioned in this document are trademarks or registered trademarks of their respective companies.