

Electronic DC Loads

SINGLE CELL LOAD SCL SERIES



- Loading down to min 0.6 V or even to 0 V (SCL ZV) at maximum current
- Basic operating modes CC, CV, CR, CP
- Combined operating modes CC+CV, CR+CC+CV, CP+CC+CV, CV+CC
- Adjustable protections for current and undervoltage
- Square, PWM and modulation function
- List function with synchronized DAQ
- MPP tracking
- Test of energy storage devices
- Internal resistance measurement function
- Data storage directly to USB flash drive
- Electronic protection
- I/O port as standard
- Galvanically isolated I/O port optional
- Bilingual help system (German/English)

SCL Series – Brief Profile

With load currents of up to 1,200 A, these electronic loads are predestined for testing fuel cells or other high-current power sources.

Two variants are available: The standard SCL operates with maximum current from an input voltage of 600 mV, the SCL ZV even from 0 V.

Functions for testing energy storage devices are integrated as standard.

Various models with different power classes are available in the compact 19" housing with only 2 height units. The modern operation via a brilliant 4.3" touch display gives the user a comfortable smartphone feeling.

All common data interfaces are standard, only GPIB is optional.

Interfaces

- RS-232
- USB
- LAN
- GPIB
- CAN
- Analog
- Analog isolated

● Standard ○ Option — not available

Operating Modes

The devices have the basic operating modes constant current, constant voltage, constant resistance and constant power (CC, CV, CR, CP mode). Additionally, a protection value for undervoltage and overcurrent can be set. This allows the combined operating modes CC+CV, CR+CC+CV, CP+CC+CV, CV+CC to be realized.

Protection, Monitoring

- | | |
|--|--|
| <ul style="list-style-type: none"> • Overcurrent protection • Undervoltage protection • Power protection • Overtemperature protection • Overvoltage indication • Reverse polarity indication | <p>Adjustable overcurrent and undervoltage protection are permanently active.</p> <ul style="list-style-type: none"> • Undervoltage protection works either with: <ul style="list-style-type: none"> • regulating transition (e.g. CC-CV operation at battery discharge) • switching transition (short dead time, e.g. when switching the input voltage) |
|--|--|

Loading Capacity, Cooling

With different voltage classes, the loads of the SCL series allow the connected DUT to be loaded at full current down to a minimum voltage of 0.6 V, the SCL ZV variants even down to 0 V. The devices are air-cooled with a stepless fan control.

I/O Port

Analog signals
in realtime!

Standard I/O port for:

Outputs:

- Analog voltage monitor output 0 ... 10 V
- Analog current monitor output 0 ... 10 V
- Load input activation state
- Status overload
- Programmable logic output
- Trigger output

Inputs:

- Analog load setting I and V with 0 ... 5 V or with 0 ... 10 V
- Analog protection setting I and V with 0 ... 10 V
- Load activation
- Operating mode selection CC - CV
- Control speed selection
- Remote shut-down
- Readable digital input
- Trigger input

Galvanically Isolated I/O Port (Option SCL06)

Option SCL06 can be installed for galvanic isolation of the analog I/O port from the load circuit. By using this card ground loops are prevented and it is possible to test bipolar voltages with common analog control using two devices.

Factory Calibration Certificate (FCC-SCLxx)

2 x for free

We supply a free Factory Calibration Certificate (FCC) with the devices. The calibration process is subject to supervision in accordance with DIN EN ISO 9001. This calibration certificate documents the traceability to national standards to illustrate the physical device in accordance with the International System of Units (SI). Within the 2-year warranty period, we will calibrate a second time free of charge if the respective device will have been registered:

<https://www.hoecherl-hackl.com/service/device-registration>

For use under laboratory conditions, H&H recommends a calibration interval of 2 years. This is an empirical value that can be used as a guide for the first period of use. Depending on the intended use, service life, relevance of the application and ambient conditions, the operator should adjust this interval accordingly.

Minimum Voltage

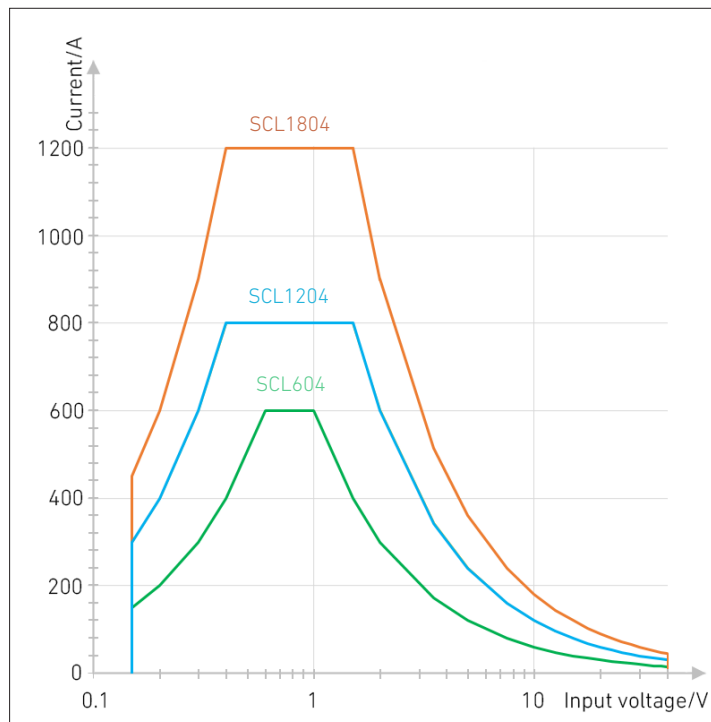

Operating range SCL standard models

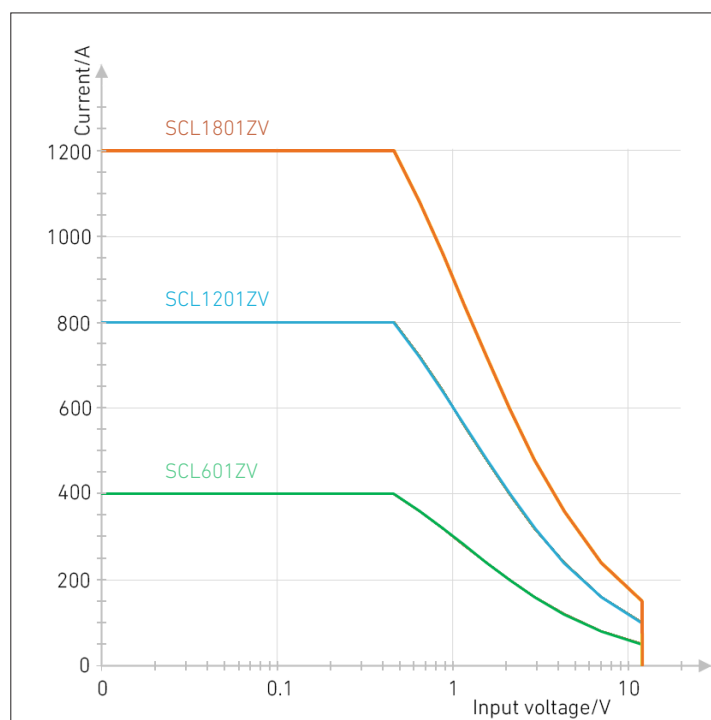

Operating range SCL ZV models

Unlike standard loads, the minimum voltage for maximum load current in the SCL series is in the millivolt range.

SCL ZV variants load with maximum current even down to 0 V. However, a current-dependent power reduction of (1 V * set current) must be calculated for these models.

Mechanics

The SCL series is designed in stable 19" technology and can be used as a desktop unit or installed in 19" racks without any additional installation kits. When installing, a vented front panel with at least 1 U must be fitted above and below the unit.

Load Terminals

In all models of the SCL series, the load connections are implemented as solid flat copper bars. Per bar, up to 2 cable lugs can be contacted on both sides with M12 screws and a maximum of 150 mm² each.

Functions

Load Profiles (List Function)

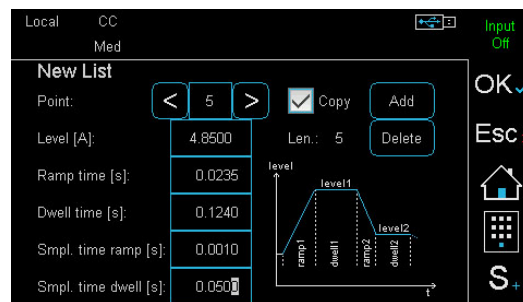

In all operating modes CC, CV, CR, CP the electronic loads can produce load profiles by List function. Up to 300 settings with variable dwell and ramp times are possible.

Voltage and current are measured synchronously and stored with a time stamp. Associated sampling times can be defined for each curve section.

Rectangular Function

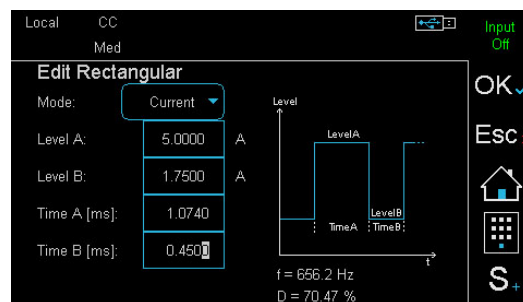

The rectangular function provides a convenient way to generate a rectangular waveform by entering absolute time and amplitude values.

PWM Function

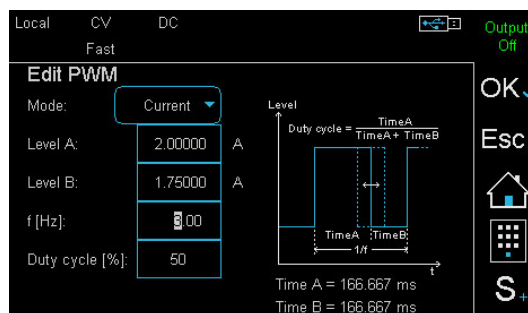

With the PWM function, the switching frequency and the duty cycle can be set for the two amplitude values in manual operation.

Modulator

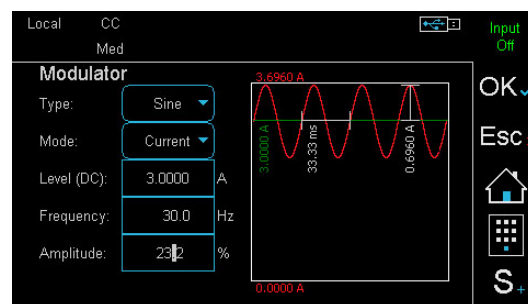

The modulator adds a sinusoidal, square-wave or triangular signal to a static setting in CC or CV mode. Frequency and modulation depth are adjustable.

MPP Tracking

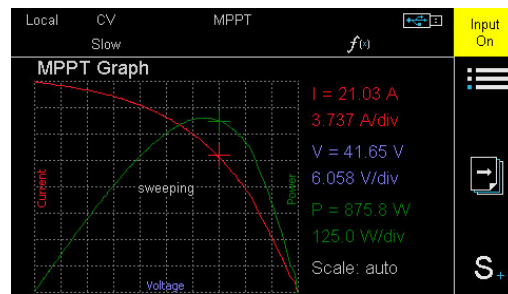

V/I and V/P characteristic at the user interface

The Maximum Power Point Tracking (MPPT) function consists of the two sub-functions Sweeping and Tracking, which alternate continuously in an adjustable interval.

If the measured open circuit voltage at startup is higher than the minimum voltage, the electronic load performs a sweep and then adjusts the global MPP found. The swept V/I curve is displayed together with the V/P curve in the function graph of the user interface. The currently determined MPP is marked by a '+' in the diagram. The V/I characteristic can be read via a data interface.

Discharge Function, Energy Storage Test

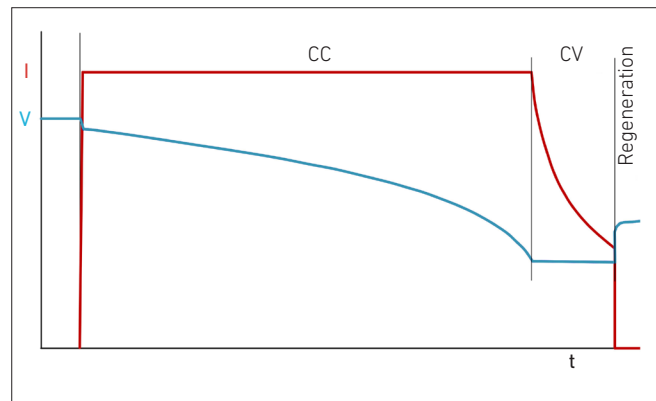

I_{Ua} discharge with follow-up time

The discharge function tests energy storage devices such as batteries, ultracaps and electrolytic capacitors etc. by discharging them in CC, CP or CR mode. The discharge function can be combined with the list function so that pulsed discharge is possible.

I_{Ua} discharge (CC+CV discharge) is also possible: the test object is discharged with constant current up to a defined voltage.

This voltage is then kept constant until a defined minimum current is reached.

Stop criteria are charge, energy, time, current, voltage.

During data logging, a follow-up time can be defined to observe the regeneration phase.

Internal Resistance Measurement

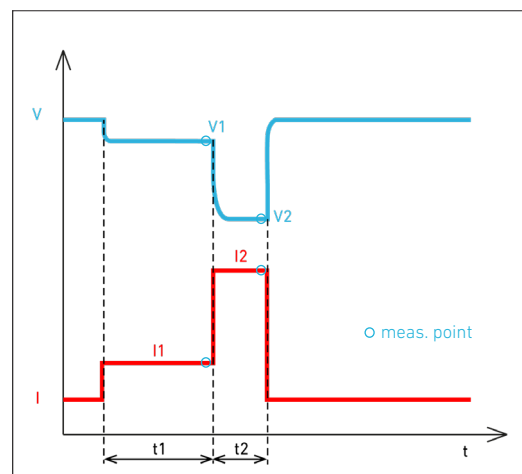

R_i calculation timing

The electronic load can measure the internal DC resistance of the connected DUT. The determination of the internal resistance R_i is based on the principle specified in various standards for batteries and accumulators, e.g. DIN EN 61951, DIN EN 61960.

At intervals of a few seconds, the load measures the terminal voltage of the DUT (V₁, V₂) at two defined load levels (I₁, I₂) and calculates R_i from this.

The load levels I₁ and I₂ as well as their durations are adjustable.

In manual mode, the load can store the parameters and the result of the measurement on a connected USB mass storage device at the touch of a button, so that a high throughput with many DUTs may be achieved.

Data Logging (DAQ)

The electronic load is able to synchronously store data records of voltage and current with time stamp internally in a defined interval. Up to 40,000 data records are stored in a ring buffer and can be read via a data interface. After recording is finished, the data can also be transferred to a USB flash drive.

For processes with storage intervals in the seconds range, the data can also be stored directly on the USB flash drive.

Sweep Function



V/I characteristic

The sweep function is used to determine V/I characteristics. For this purpose, a voltage ramp is defined via the user interface by means of start and end voltage as well as the corresponding duration of the sweep process. The ramp can be rising or falling.

During the sweep process, the load continuously changes the voltage value until the end voltage is reached and records the measurement data. After the function execution, the recorded measurement data can be viewed in the graphical Data Viewer or exported to a connected USB flash drive.

Trigger Model

Several functions or settings can be triggered by a configurable trigger model:

- Activate/deactivate load input
- Start/stop LIST function
- Start/stop data acquisition
- Set triggered settings of all operating modes

Available trigger sources:

- Extern
- Bus
- Manual
- Voltage
- Current

Changing Regulation Speed

Sometimes special DUTs or very long load cables require modification of the electronic load's regulation time constant to avoid oscillations and establish stable operation.

Regulation speed slow - medium - fast are selectable. See model overview.

Watchdog Function

In digital remote operation, the electronic load has got a watchdog function switching the load input off if the previously programmed watchdog delay expires without resetting the watchdog.

The watchdog delay is set by SCPI command. Another command activates the watchdog. Then the control program must ensure that the command to reset the watchdog is sent periodically to the electronic load before the delay time expires.

Save Settings

In order to be able to quickly reconstruct recurring test tasks, the settings active in the electronic load can be stored in non-volatile memory (internal or external to USB flash drive) so that they can be reloaded at a later time. 9 internal memory positions are available.

The load can alternatively set reset values at power-up or memory position 1 to 9.

Drivers



Current NI-certified LabVIEW drivers can be downloaded here:
www.ni.com/downloads/instrument-drivers/

Model (Order number)	SCL604	SCL1204	SCL1804
Maximum input voltage V_{max}	40 V	40 V	40 V
Minimum input voltage V_{min} ¹⁾	0.6 V	0.6 V	0.6 V
Maximum current I_{max}	400 A	800 A	1,200 A
Maximum power ²⁾	600 W	1,200 W	1,800 W
Voltage setting	0 ... 40 V	0 ... 40 V	0 ... 40 V
Current setting	0 ... 400 A	0 ... 800 A	0 ... 1,200 A
Resistance setting	0.0015 ... 1.008 Ω	0.00075 ... 0.504 Ω	0.0005 ... 0.336 Ω
Power setting	0 ... 600 W	0 ... 1,200 W	0 ... 1,800 W
Rise and fall time fast / medium / slow ³⁾	2 / 10 / 100 ms	2 / 10 / 100 ms	2 / 10 / 100 ms
Input capacity ca.	16 μ F	33 μ F	50 μ F
Mains voltage ⁴⁾	1/N/PE AC 230 V 50 ... 60 Hz	1/N/PE AC 230 V 50 ... 60 Hz	1/N/PE AC 230 V 50 ... 60 Hz
Power consumption	70 VA	80 VA	75 VA
Noise max. ca. ⁵⁾	73 dB(A)	74 dB(A)	64 dB(A)
Load terminals ⁶⁾	FKS30/10-SM12	FKS30/10-SM12	FKS30/10-SM12
Weight ca.	16 kg	19 kg	22 kg
Housing / 3D model ⁷⁾	19", 2 U / SCL_M1	19", 2 U / SCL_M1	19", 2 U / SCL_M1

Model (Order number)	SCL601ZV	SCL1201ZV	SCL1801ZV
Maximum input voltage V_{max}	12 V	12 V	12 V
Minimum input voltage V_{min} ¹⁾	0 V	0 V	0 V
Maximum current I_{max}	400 A	800 A	1,200 A
Maximum power ²⁾	600 W	1,200 W	1,800 W
Voltage setting	0 ... 12 V	0 ... 12 V	0 ... 12 V
Current setting	0 ... 400 A	0 ... 800 A	0 ... 1,200 A
Resistance setting	0 ... 1.302 Ω	0 ... 0.151 Ω	0 ... 0.101 Ω
Power setting	0 ... 600 W	0 ... 1,200 W	0 ... 1,800 W
Rise and fall time fast / medium / slow ³⁾	2 / 10 / 100 ms	2 / 10 / 100 ms	2 / 10 / 100 ms
Input capacity ca.	16 μ F	33 μ F	50 μ F
Mains voltage ⁴⁾	1/N/PE AC 230 V 50 ... 60 Hz	1/N/PE AC 230 V 50 ... 60 Hz	1/N/PE AC 230 V 50 ... 60 Hz
Power consumption	685 VA	1,155 VA	1,725 VA
Noise max. ca. ⁵⁾	69 dB(A)	75 dB(A)	75 dB(A)
Load terminals ⁶⁾	FKS30/10-SM12	FKS30/10-SM12	FKS30/10-SM12
Weight ca.	16 kg	20.5 kg	24.5 kg
Housing / 3D model ⁷⁾	19", 2 U / SCL_M1	19", 2 U / SCL_M1	19", 2 U / SCL_M1

1. Minimum input voltage for maximum static load current. Linear derating of the load current at lower voltages.
2. For the ZV variants, a current-dependent power reduction of (1 V * set current) must be considered.
3. Rise and fall times are defined from 10 ... 90 % and 90 ... 10 % of maximum current (constant current mode, tolerance ± 20 %).
4. Mains voltage tolerance ± 10 %.
5. Measured at the front in distance of 1 m.
6. Description of available terminals starting at page 123.
7. 1 U = 44.45 mm. Detailed dimensions by means of 3D models at www.hoechert-hackl.com/downloads.

Options and Accessories

Order number	Article	Description
52-200-001-28	SCL02	GPIO interface extension
67-004-030-28	K-RS-SNM 9-9	RS-232 cable (null-modem cable)
53-100-002-28	SCL06-N	Galvanically isolated I/O port instead of standard I/O port with new device
53-100-001-28	SCL06	Galvanically isolated I/O port for retrofitting of existing device
67-008-020-28	K-MS-SCL+K-MS-CAN	Cable set master-slave, consisting of K-MS-SCL and K-MS-CAN (2 m each)
67-036-020-28	K-MS-SCL	Master-slave cable I/O port (2 m)
67-037-020-28	K-MS-CAN	Master-slave cable CAN (2 m)
63-000-006-28	SubD25 Doubler	Adapter 1x Sub-D 25 male connector to 2x Sub-D25 female connector for I/O port
65-002-000-28	FCC-SCLxx	Factory Calibration Certificate
63-000-005-28	PH2/7.62-ST16	Additional mating connector for sense terminal
63-000-003-00	SENSADAPT/PH2/POK/60V	Sense-Adapter from Phoenix PH2 to 4 mm binding post, max. 60 V
49-001-000-28	SX	Modified setting range for SCL Series only after consulting H&H
49-002-000-28	SSX	Customized setting range only after consulting H&H
		Load cables see starting at page 127



Operating modes, functions		
Basic operating modes	CC, CP, CR, CV	
Combined operating modes	CC+CV, CR+CC+CV, CP+CC+CV, CV+CC	
Functions	DC load MPP Tracking energy storage device test internal resistance measurement list function rectangular function PWM function modulation (sine, triangle, square) data acquisition (internally or to USB flash drive) sweep function save and recall of device settings watchdog in remote operation	
User interface	4.3" TFT touch display	
Accuracy of setting		
	of setting	of corresponding range
Voltage	±0.1 %	±0.05 %
Current	±0.2 %	±0.05 %
Resistance (at 5 % to 100 % of voltage range)	±1.4 %	±0.5 % of resistance range ±0.3 % of current range
Power (at V and I > 30 % of range)	±0.35 %	±0.1 %
(at V and I > 5 % and < 30 % of range)	±0.7 %	±0.25 %
Resolution	14 bits	
Accuracy of adjustable protections		
	of setting	of corresponding range
Overcurrent protection	±1 %	±0.2 %
Undervoltage protection	±0.5 %	±0.2 %
Resolution	12 bits	
Accuracy of measurement slow		
	of measured value (real value)	of corresponding range
Voltage	±0.025 %	±0.01 %
Current	±0.2 %	±0.05 %
Resistance	is calculated from current and voltage	
Power	is calculated from current and voltage	
Resolution	23 bits	
Sampling time	250 ms, not triggerable	
Accuracy of display		
Number of decimal places	4	
Accuracy	accuracy of measurement slow ±1 digit of the display value	
Accuracy of measurement fast		
	of measured value (real value)	of corresponding range
Voltage	±0.2 %	±0.05 %
Current	±0.2 %	±0.1 %
Resistance	is calculated from current and voltage	
Power	is calculated from current and voltage	
Resolution	16 bits	
Sampling time	200 µs ... 1,000 s, resolution 200 µs	
Accuracy of trigger voltage and current		
Trigger voltage	±1 % of voltage range	
Trigger current	±1 % of current range	
Sampling time	200 µs	

Dynamic function LIST	
Operating modes	CC, CV, CR, CP
No. of load levels	max. 300, with corresponding ramp and dwell times
Accuracy of load levels	see accuracy of setting
Dwell time ¹⁾	200 µs ... 1,000 s
Ramp time ¹⁾	0 ... 1,000 s
Resolution	200 µs
Accuracy of setting times	±0.02 %
Sampling time	see accuracy of measurement fast
Delay at triggered start	max. 300 µs
Dynamic function rectangular	
Operating modes	CC, CV, CR
No. of load levels	2
Accuracy of load levels	see accuracy of setting
Pulse times ¹⁾ , resolution	1 µs ... 9999.999 ms, resolution 1 µs
Accuracy of setting times	0.02 %
Dynamic function PWM	
Operating modes	CC, CV, CR
No. of load levels	2
Accuracy of load levels	see accuracy of setting
Frequency ¹⁾ , resol.	0.1 Hz ... 10 kHz, resolution 0.1 Hz
Duty cycle, resol.	1 ... 99 %, resolution 1 %
Dynamic function modulation	
Operating modes	CC, CV
Waveforms	sine, square, triangle
Frequency ¹⁾ , resol.	0.1 Hz ... 10 kHz, resolution 0.1 Hz
Modulation depth	0 ... 100 %
Data acquisition	
to external USB flash drive	
Sampling time	0.1 ... 30.0 s, resolution 0.1 s
Measurement data	timestamp, voltage, current
No. of measurement points	limited by flash drive memory capacity
File format	.csv
Accuracy	see accuracy of measurement slow
to internal memory	
Sampling time	200 µs ... 1,000 s, resolution 200 µs, synchronized with dynamic function
Measurement data	timestamp, voltage, current
No. of measurement points	max. 40,000
Accuracy	see accuracy of measurement fast
Settings memory	
No. of memory positions	9, selectable (incl. programmed list)
I/O port: inputs and outputs	
Inputs	analog load setting I and V with 0 ... 5 V and 0 ... 10 V analog protection setting I and V with 0 ... 10 V load input activation (low active) operating mode selection CC/CV control speed selection remote shut-down (high active) readable digital input (by SCPI command) trigger input (high active) control input (activates analog signals, low active)
Digital input level	logical low: 0 ... 0.8 V, logical high: 3 ... 30 V

The specified accuracies refer to an ambient temperature of 23 ±5 °C. The specified accuracies are valid when the sense lines are connected and when the unit is connected to undisturbed voltages (ripple and noise < 0.1 %). At voltages with higher disturbance values the accuracy can change for the worse.

1. The applicable time or frequency range is limited by the rise/fall time of the respective model.
2. positive/negative DC voltage or RMS value of a sinusoidal AC voltage
3. only 0 ... 10 V

Technical Data

Outputs	analog voltage monitor output 0 ... 10 V analog current monitor output 0 ... 10 V load input activation state (low active) overload status (OV, OCP, OPP, OTP, low active) programmable logic output (by SCPI command) trigger output (low active)	
Digital output level	Standard: logical low: 0 ... 0.8 V, logical high: 5 V, max. 10 mA (push-pull) Isolated: logical low: 0 ... 0.8 V, logical high: 5 V/24 V selectable, max. 10 mA (push-pull)	
I/O port: accuracy of analog control 0 ... 5 V or 0 ... 10 V		
	of setting	of corresponding range
Voltage	±0.1 %	±0.05 %
Current	±0.2 %	±0.1 %
Overcurrent protection ³⁾	±1 %	±0.2 %
Undervoltage protection ³⁾	±0.5 %	±0.2 %
	input resistance of analog inputs >10 kΩ	

I/O port: accuracy of analog monitor outputs 0 ... 10 V		
	of analog signal of actual value	offset voltage
Voltage	±0.2 %	±15 mV
Current	±0.2 %	±15 mV
	minimum load > 2 kΩ	

I/O port: permissible voltages		
	standard I/O port	isolated I/O port (option SCL06)
Vin-io (GND - neg. load input)	max. 2 V	max. 185 V ²⁾
VioPE (GND - PE)	max. 60 V ²⁾	max. 125 V ²⁾

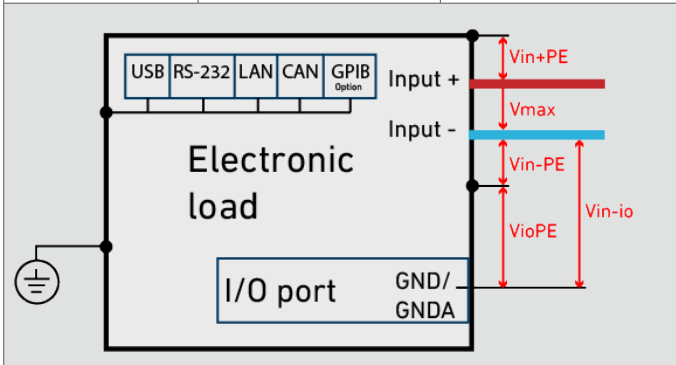

Input		
Input resistance	>50 kΩ when load input is off standard models with diode function at reverse polarity up to nominal current ZV models have no reverse polarity protection!	
Input capacity	see model overview	
Max. input voltage Vmax	see model overview	
Min. input voltage Vmin	see model overview	
Input: permissible voltages		
	standard I/O port	isolated I/O port (option SCL06)
Vin-PE (neg. load input - PE)	max. 60 V ²⁾	max. 60 V ²⁾
Vin+PE (pos. load input - PE)	max. 60 V ²⁾	max. 60 V ²⁾
Power		
Continuous power	see model overview (at Ta = 21 °C)	
Derating	-1.2 %/°C for Ta > 21 °C	

Protection and monitoring	
Protective devices	overcurrent overpower overtemperature
Monitoring	overvoltage indication reverse polarity indication undervoltage indication (if the input voltage is too low for the set current)

Terminals	
Load input	see model overview
Sense	PH2/7.62-BU16, see starting at page 123

Operating conditions	
Operating temperature	5 ... 40 °C
Stock temperature	-25 ... 65 °C
Max. operating height	2,000 m above sea level
Pollution degree	2
Overvoltage category of mains	II
Max. humidity	80 % at 31 °C, linear decreasing to 50 % at 40 °C
Min. distance rear panel to wall or other objects	70 cm
Cooling	2-stage air cooling
Cabinet installation	with minimum 1 U vented front panel each above and below the device
Noise, weight	see model overview
Mains voltage	see model overview
Mains cable	length max. 3 m cross-section of mains leads min. 1 mm ²
Power consumption	see model overview

Housing	
Dimensions	see model overview
Color	front: RAL7035 (light grey) rear: stainless steel top: RAL7037 (dusty grey)
Safety and EMC	
Protection class	1
Measuring category	O (CAT I according to EN 61010:2004)
Electrical safety	DIN EN 61010-1 DIN EN 61010-2-030
EMC	DIN EN 61326-1 DIN EN 55011 DIN EN 61000-3-2 DIN EN 61000-3-3

Standard interfaces	
Data interfaces	RS-232, USB, LAN, CAN
I/O port	standard (not isolated)

Available options	
Data interface SCL02	GPIB
Hardware extensions SCL06	galvanically isolated I/O port

Calibration, warranty	
FCC-SCLxx	Factory Calibration Certificate, twice for free ⁴⁾
Recommended calibration interval	2 years
Warranty	2 years

Technical data of production series A, rev. 2. Subject to technical changes without notice. The specified accuracies refer to an ambient temperature of 23 ±5 °C. The specified accuracies are valid when the sense lines are connected and when the unit is connected to undisturbed voltages (ripple and noise < 0.1 %). At voltages with higher disturbance values the accuracy can change for the worse.

1. The applicable time or frequency range is limited by the rise/fall time of the respective model.
2. positive/negative DC voltage or RMS value of a sinusoidal AC voltage
3. only 0 ... 10 V
4. The second calibration is free of charge if the particular device has been registered with H&H: www.hoecherl-hackl.com/service/device-registration