



# DL SERIES

## DC ELECTRONIC LOAD



### OPERATING MANUAL

For Models: DL115, DL215, DL515, DL150, DL250, DL550

## Table of Contents

<b>1</b>	<b>Introduction .....</b>	<b>1</b>
1.1	About This Manual .....	1
1.2	Warranty Information .....	2
1.3	Safety .....	3
1.3.1	<i>Safety Symbols</i> .....	3
1.3.2	<i>Warning Summary</i> .....	3
1.3.3	<i>Power and Grounding</i> .....	3
1.3.4	<i>Terminals and Wiring</i> .....	4
1.3.5	<i>Environment</i> .....	4
1.4	Models and Accessories .....	5
1.5	Specifications .....	6
1.5.1	<i>Key Features</i> .....	7
1.5.2	<i>Displayed Results</i> .....	7
1.5.3	<i>Protection</i> .....	8
1.5.4	<i>Loading Method</i> .....	8
1.5.5	<i>Detailed Loading and Measurement Specifications</i> .....	8
1.6	Loading Level Selection .....	19
1.7	User Loading Timing Limits .....	19
1.8	Loading Timing Accuracy .....	20
1.9	Oscilloscope .....	20
1.10	Parallel Operation .....	20
1.11	Interfaces .....	20
1.12	Physical .....	21
1.13	Environmental .....	21
1.14	Certification .....	21
<b>2</b>	<b>Getting Started .....</b>	<b>22</b>
2.1	Unpacking and Inspection .....	22
2.2	Rack Mount Installation .....	23
2.3	Update the firmware .....	26
2.4	Periodic Maintenance .....	26
2.5	DL Series Front and Rear Panel Overview .....	27
2.6	Powering on .....	29
2.7	Power Off .....	30
<b>3</b>	<b>Theory of Operation .....</b>	<b>31</b>
3.1	Terms .....	32
3.2	Ensuring Accuracy .....	32
3.2.1	<i>Wiring Impedance and Inductance</i> .....	32
3.3	DC Loading Regions .....	33
3.4	DC Load Regulation Stability .....	35
<b>4</b>	<b>Menu Structure .....</b>	<b>38</b>

4.1	Introduction .....	38
4.2	Quickstart .....	38
4.3	Menu Summary .....	39
4.4	Common Display Elements .....	40
4.5	Common Behavior .....	41
4.5.1	<i>Touch Panel Operation</i> .....	41
4.5.2	<i>OK/Cancel</i> .....	41
4.5.3	<i>SI Conformance</i> .....	41
4.5.4	<i>Small Line Plot</i> .....	41
4.5.5	<i>Trace Settings</i> .....	42
4.5.6	<i>Settings</i> .....	42
4.6	Load Status and Control Buttons .....	42
4.7	Status Bar .....	43
4.7.1	<i>Item Behavior</i> .....	43
4.7.2	<i>System Alerts and Faults</i> .....	45
4.8	Dial Settings .....	45
<b>5</b>	<b>Front Panel Operations .....</b>	<b>48</b>
5.1	Results .....	48
5.1.1	<i>Introduction</i> .....	48
5.1.2	<i>Numeric Results</i> .....	49
5.1.3	<i>Scope</i> .....	52
5.1.4	<i>X/Y</i> .....	57
5.1.5	<i>History</i> .....	59
5.2	DC Load menu .....	61
5.2.1	<i>Loading</i> .....	61
5.2.2	<i>General</i> .....	68
5.2.3	<i>Profiles</i> .....	72
5.2.4	<i>Data Logging</i> .....	73
5.3	System .....	78
5.3.1	<i>About</i> .....	78
5.3.2	<i>Configuration Menu</i> .....	80
5.3.3	<i>Export/import settings</i> .....	92
5.3.4	<i>Self-Test</i> .....	95
<b>6</b>	<b>Remote Operation .....</b>	<b>98</b>
6.1	Computer Control of the DL .....	98
6.1.1	<i>LAN (Ethernet) Interface</i> .....	98
6.1.2	<i>Connecting to the LAN Interface</i> .....	98
6.1.3	<i>IP Addressing</i> .....	98
6.1.4	<i>Writing Software to Control the DL via LAN</i> .....	99
6.1.5	<i>USB Interface</i> .....	101
6.2	IEEE488.2 Compatibility .....	103
6.3	SCPI 1999.0 Compatibility .....	103
6.4	Command Syntax .....	103
6.4.1	<i>Command Errors</i> .....	103

6.4.2	<i>Special Characters</i> .....	103
6.4.3	<i>Fields within a Command</i> .....	104
6.5	Responses to Commands .....	106
6.5.1	<i>Response Fields</i> .....	107
6.6	Program Messages Affecting Loading .....	108
6.7	Command Summaries .....	108
6.8	Command Details .....	118
6.8.1	<i>IEEE Mandated Commands</i> .....	118
6.8.2	<i>System Remote/Local access commands</i> .....	120
6.8.3	<i>System Event/Error query commands</i> .....	120
6.8.4	<i>Source loading common configuration commands</i> .....	121
6.8.5	<i>Source loading level A and B configuration commands</i> .....	124
6.8.6	<i>Loading operation commands</i> .....	132
6.8.7	<i>Scope Capture configuration commands</i> .....	133
6.8.8	<i>Scope Capture control and data commands</i> .....	135
6.8.9	<i>Measurement control commands</i> .....	135
6.8.10	<i>Measurement query commands</i> .....	136
6.8.11	<i>Device configuration commands</i> .....	144
6.9	Device Synchronization .....	148
<b>7</b>	<b>DIO Interface</b> .....	<b>149</b>
7.1	DIO Connector and Pinout .....	149
7.2	DIO Signal Characteristics .....	150
<b>8</b>	<b>WEB Browser Interface</b> .....	<b>152</b>
<b>9</b>	<b>Efficiency Measurement Integration</b> .....	<b>161</b>
<b>10</b>	<b>Troubleshooting</b> .....	<b>162</b>
10.1	Calibration.....	162
10.2	Critical Fault .....	163
10.3	Overvoltage.....	163
10.4	Over temperature .....	164
10.5	Fan Fault.....	164
10.6	DC Load Limiting.....	165
<b>A.</b>	<b>LAN Presence</b> .....	<b>166</b>
<b>B.</b>	<b>Installing Virtual COM Ports on Windows Variants</b> .....	<b>168</b>

### List of Figures

Figure 2-1	Side Dimensions of the DL.....	22
Figure 2-2	Front Dimensions of DL.....	23
Figure 2-3	Front Panel Overview.....	27
Figure 2-4	Rear Panel Overview.....	28
Figure 2-5	Initialization Screen .....	29
Figure 3-1	Loading Hierarchy.....	31

Figure 4-1 Numeric Results .....	38
Figure 4-2 Scope.....	38
Figure 4-3 XY Chart.....	38
Figure 4-4 History Chart.....	38
Figure 4-5 Loading Configuration.....	39
Figure 4-6 System->About .....	39
Figure 4-7 Typical Start Screen.....	39
Figure 4-8 DL Series Display Overview.....	40
Figure 4-9 DL Series Status Bar .....	43
Figure 4-10 Example Alert Notification.....	45
Figure 4-11 Load Active Screen.....	46
Figure 4-12 Adjust Level A Current .....	46
Figure 4-13 Dial Rotation Scroll Cursor.....	46
Figure 4-14 Select Digit to Alter .....	47
Figure 5-1 Real-Time Numeric Results Screen.....	49
Figure 5-2 Scope Results Screen .....	52
Figure 5-3 Scope Capture Settings .....	53
Figure 5-4 Scope Trace Preferences.....	54
Figure 5-5 Present Scaling and Cursor Readouts Example .....	55
Figure 5-6 Per-Division Time Interval.....	55
Figure 5-7 Scope Scaling.....	56
Figure 5-8 X/Y Results Screen.....	57
Figure 5-9 XY Chart Settings.....	58
Figure 5-10 X/Y Plot Y-Axis Preferences.....	58
Figure 5-11 X/Y Plot X-Axis Preferences.....	58
Figure 5-12 History Results Screen .....	59
Figure 5-13 History Chart Options.....	60
Figure 5-14 History Trace Preferences.....	60
Figure 5-15 Loading Configuration Screen .....	61
Figure 5-16 Stepped Levels Arbitrary and Sweep .....	61
Figure 5-17 Level A Table Screen .....	62
Figure 5-18 Level A Arbitrary Screen .....	64
Figure 5-19 Level A Edit Arbitrary Entry #3.....	65
Figure 5-20 Level A Sweep Screen .....	66
Figure 5-21 Sweep Slope.....	66
Figure 5-22 Level A OCP Screen .....	67
Figure 5-23 General Load Settings .....	68
Figure 5-24 Change Limits Screen.....	68
Figure 5-25 Soft-Start Screen.....	69
Figure 5-26 RHF Configuration.....	69
Figure 5-27 RHF User Mode .....	70
Figure 5-28 Battery Testing Settings Screen.....	70
Figure 5-29 User Trip Voltage .....	71
Figure 5-30 Measurement Settings .....	71
Figure 5-31 Save to Profile.....	72
Figure 5-32 Recall a Profile Screen .....	73
Figure 5-33 Data Logging Settings .....	73
Figure 5-34 Select Log Data Items.....	74

Figure 5-35 Stop Data Logging.....	75
Figure 5-36 Manage Data Log File(s) .....	76
Figure 5-37 File Deletion.....	76
Figure 5-38 Export Log.....	76
Figure 5-39 About System Screen.....	78
Figure 5-40 System Update in About Menu .....	79
Figure 5-41 Update - Install Files.....	79
Figure 5-42 Update Firmware Status.....	80
Figure 5-43 Configuration Screen.....	80
Figure 5-44 Power On Options Screen .....	81
Figure 5-45 Efficiency Options Screen .....	82
Figure 5-46 Interface Options Screen.....	83
Figure 5-47 Result Preferences Screen.....	84
Figure 5-48 Clock Settings Screen .....	84
Figure 5-49 DIO Settings .....	85
Figure 5-50 DIO Mode Setting .....	86
Figure 5-51 Display Screen .....	86
Figure 5-52 Terminal Settings.....	88
Figure 5-53 LAN Configuration Screen .....	89
Figure 5-54 LAN Configuration Factory Reset Confirm .....	90
Figure 5-55 LAN Configuration – Manual Setting .....	91
Figure 5-56 Load Trigger Options .....	91
Figure 5-57 Real-Time Loading Screen.....	92
Figure 5-58 Export Settings Screen .....	94
Figure 5-59 Self-Test Screen .....	95
Figure 5-60 Self-test Cannot Start .....	95
Figure 5-61 Self-test Running.....	96
Figure 5-62 Self-Test Results .....	96
Figure 5-63, Self-test Failed.....	97

**List of Tables**

Table 1-1 Model Specifications ..... 6

Table 4-1 Menu Summary .....39

Table 4-2 Load Status Descriptions .....42

Table 4-3 Status Bar Item Behavior .....43

Table 5-1 Result Displays .....48

Table 5-2 Loading Level Examples.....48

Table 5-3 Load Level Manual Switch.....49

Table 5-4 Numeric Result Views .....50

Table 5-5 Numeric Result Indicators .....51

Table 5-6 Scope Results Trigger Conditions.....53

Table 5-7 Results X/Y Data Source.....57

Table 5-8 Data Logging Settings .....74

Table 6-1 IEEE Mandated commands.....108

Table 6-2 System Remote Locking commands.....109

Table 6-3 System Event/Error Query Commands .....110

Table 6-4 Source Loading Common Configuration Commands .....111

Table 6-5 Source Loading Level A and B Configuration Commands.....112

Table 6-6 Loading Operation Commands .....114

Table 6-7 Scope Capture Configuration Commands .....114

Table 6-8 Scope Capture Operation Commands.....115

Table 6-9 Measurement Control Commands.....115

Table 6-10 Measurement Query Commands.....116

Table 6-11 Device Configuration Commands.....117

# 1 Introduction

## 1.1 About This Manual

This document is formatted to be viewed on a computer using a suitable reader application, instead of printed as a hard copy; however, if it is printed, it should be in color.

It is not necessary to read the entire manual; rather, it is recommended that the user view the table of contents and select those sections applicable to the intended application.

The user may click on any entry in the table of contents to go to the desired section. The table of contents is also available as bookmarks for Adobe Reader or Acrobat; this allows the user to permanently display it alongside the document and navigate it by clicking on each section as needed.

This document applies to the DL Series models with a main firmware revision of 1.0.4; there may be differences if the instrument has a different main firmware version.

Also, images of actual DL screens are shown throughout the manual. The screen displayed may be slightly different from that shown in this manual due to the specific model number, changes to firmware, differences in DL model option content, or configuration settings in the DL.

Software/Firmware upgrades might change or add product features. Please acquire the latest version of the manual from the Vitrek website.

Document number MO-DLxxx-GOM-022120.

Copyright© 2021 Vitrek.

All rights reserved. Except as permitted under the U.S. Copyright Act of 1976, no part of this publication may be reproduced, distributed, or transmitted in any form or by any means, or stored in a database or retrieval system, without the prior written permission of from Vitrek. This document is copyrighted and contains proprietary information, which is subject to change without notice. The product displays and instructional text may be used or copied only in accordance with the terms of the license agreement.

In the interest of continued product development, Vitrek reserves the right to make changes in this document and the product it describes at any time, without notice or obligation.

Information in this document replaces all previously published materials.

Vitrek shall not be liable for either incidental or consequential losses in connection with the furnishing, use, or performance of this manual as well as any information contained.

Vitrek, LLC  
12169 Kirkham Rd.  
Poway, CA 92064 USA  
Telephone: 858-689-2755 Fax : 858-689-2760  
Web : [www.Vitrek.com](http://www.Vitrek.com) Email : [sales@Vitrek.com](mailto:sales@Vitrek.com)



---

## **1.2 Warranty Information**

---

This Vitrek instrument is warranted against defects in material and workmanship for a period of one year after the date of purchase. Vitrek agrees to repair or replace any assembly or component (except batteries) found to be defective, under normal use, during the warranty period. Vitrek's obligation under this warranty is limited solely to repairing any such instrument that, in Vitrek's sole opinion, proves to be defective within the scope of the warranty, when returned to the factory or to an authorized service center. Transportation to the factory or service center is to be prepaid by the purchaser. Shipment should not be made without prior authorization by Vitrek.









This warranty does not apply to any products repaired or altered by persons not authorized by Vitrek or not in accordance with instructions provided by Vitrek. If the instrument is defective as a result of misuse, improper repair, improper shipment, or abnormal conditions or operations, repairs will be billed at cost.

Vitrek assumes no responsibility for its products being used in a hazardous or dangerous manner, either alone or in conjunction with other equipment. Special disclaimers apply to this instrument. Vitrek assumes no liability for secondary charges or consequential damages, and in any event, Vitrek's liability for breach of warranty under any contract or otherwise shall not exceed the original purchase price of the specific instrument shipped and against which a claim is made.

Any recommendations made by Vitrek or its representatives for uses of its products are based on tests believed to be reliable, but Vitrek makes no warranties of the results to be obtained. This warranty is in lieu of all other warranties, expressed or implied, and no representative or person is authorized to represent or assume for Vitrek any liability in connection with the sale of our products, other than set forth herein.



## 1.3 Safety

### 1.3.1 Safety Symbols

 <b>WARNING</b>	<b>WARNING</b> highlights an operating or maintenance procedure, condition or statement that could result in injury to or death of personnel.
 <b>CAUTION</b>	<b>CAUTION</b> highlights an operating or maintenance procedure, condition or statement that could result in damage to or destruction of equipment.
 <b>NOTE</b>	<b>NOTE</b> highlights essential information for operating and maintenance procedures, or conditions.
	DANGER – High Voltage
	Safety Warning
	Protective Earth Terminal
	Chassis Ground
	Test Ground

### 1.3.2 Warning Summary

The user should read and be aware of these safety warnings at all times while using the DL.

 <b>WARNING</b>	SOME VOLTAGES AND CURRENTS MEASURED ON THE DL MAY BE LETHAL. UNSAFE OPERATION MAY RESULT IN SEVERE INJURY OR DEATH.
 <b>WARNING</b>	DO NOT USE THE DL IN A MANNER NOT SPECIFIED BY VITREK, OR PROTECTION PROVIDED BY THE EQUIPMENT MAY BE IMPAIRED AND PERSONAL SAFETY MAY BE COMPROMISED.

### 1.3.3 Power and Grounding

 <b>WARNING</b>	WHEN OPERATING THE DL, ALWAYS USE A POWER CORD THAT HAS A PROTECTIVE GROUND WIRE INSERTED INTO A POWER OUTLET THAT HAS A PROTECTIVE GROUND TERMINAL. IF THE DL IS NOT POWERED FROM A SUITABLE POWER SOURCE, OR IT IS LIKELY THAT THE POWER CORD MAY BE REMOVED FROM THE DL WHEN SIGNALS ARE APPLIED TO THE MEASUREMENT
--	--

TERMINALS, THEN THE CHASSIS GROUND TERMINAL ON THE REAR PANEL MUST BE PROTECTIVE GROUNDED.



DO NOT REMOVE THE POWER CORD FROM THE DL OR FROM THE SOURCE OF POWER WHILE IT IS MEASURING HIGH VOLTAGES. THIS WILL REMOVE THE PROTECTIVE GROUND FROM THE CHASSIS OF THE DL, WHICH MAY RESULT IN HAZARDOUS VOLTAGES BEING ACCESSIBLE TO THE USER.



DO NOT OPERATE THE DL WITHOUT A COVER, REPAIR AND INTERNAL ADJUSTMENTS MUST BE MADE BY QUALIFIED SERVICE-TRAINED MAINTENANCE PERSONNEL.



DO NOT INSERT ANY OBJECT INTO VENTILATION OR OTHER OPENINGS IN THE DL.

### 1.3.4 Terminals and Wiring



ENSURE NO VOLTAGE OR CURRENT IS PRESENT WHEN CONNECTING TO OR DISCONNECTING FROM THE TERMINALS. THE DL MEASURES VOLTAGES AND CURRENTS THAT MAY BE LETHAL. ENSURE THE BLADE TERMINAL COVER IS INSTALLED WHEN APPLYING UNSAFE VOLTAGES.



THE USER MUST UTILIZE WIRE THAT IS RATED FOR THE HIGHEST EXPECTED VOLTAGE AND CURRENT FOR ALL CONNECTIONS TO THE DL.

### 1.3.5 Environment



THE DL SHOULD NOT BE USED IN AN ENVIRONMENT WHERE CONDUCTIVE POLLUTION CAN OCCUR (E.G. IN AN OUTDOOR ENVIRONMENT). CONDUCTIVE POLLUTION IS EQUIVALENT TO INDOOR POLLUTION DEGREE 2 ENVIRONMENT.



IF THE DL IS TRANSPORTED BETWEEN DIFFERING ENVIRONMENTS AND CONDENSATION IS SUSPECTED, THE UNIT SHOULD REMAIN UNPOWERED FOR SUFFICIENT TIME FOR CONDENSATION TO HAVE DISSIPATED. IF THE DL IS USED WHILE CONDENSATION EXISTS IN THE UNIT, ELECTRIC SHOCK MAY OCCUR. IF THERE IS ANY DOUBT, CONTACT VITREK FOR ADVICE.



IF FLUIDS OR OTHER CONDUCTIVE MATERIALS ARE ALLOWED TO ENTER THE DL ENCLOSURE, EVEN IF NOT POWERED, THE DL SHOULD BE IMMEDIATELY TAKEN OUT OF OPERATION AND SERVICED, AS SAFETY MAY HAVE BEEN COMPROMISED DUE TO A POSSIBLE SHOCK HAZARD.

## **1.4 Models and Accessories**

---

Six models of the Vitrek DC Load are available; at this time, the model numbers are:

- DL115 – 150V/21A/125W/ DC Load with 3.6kW/32A transient capability
- DL215 – 150V/42A/250W/ DC Load with 7.25kW/65A transient capability
- DL515 – 150V/84A/500W DC Load with 14.5kW/130A transient capability
- DL150 – 500V/21A/500W DC Load with 2.4kW/32A transient capability
- DL250 – 500V/42A/250W DC Load with 4.8kW/65A transient capability
- DL550 – 500V/84A/500W DC Load with 9.6kW/130A transient capability

## 1.5 Specifications

Table 1-1 Model Specifications

	DL115	DL150	DL215	DL250	DL515	DL550	
<b>VOLTAGE</b>							
<b>Input Voltage</b>	0-150V	0-500V	0-150V	0-500V	0-150V	0-500V	
<b>Voltage Measurement Accuracy</b>	0.04%+1mV						
<b>Voltage (CV) Loading</b>	Full range of voltages, user configurable resistance from 1mΩ upwards						
<b>CV Loading Accuracy</b>	0.04%+1mV						
<b>Sense Loading</b>	Nominally 923kΩ, automatically included in all measurement results and all loading except open						
<b>CURRENT</b>							
<b>Min. Current</b>	10μA	60μA	20μA	120μA	50μA	250μA	
<b>Max. Current</b>	>1s	21A		42A		84A	
	100ms	30A		60A		120A	
	<10ms	30A		60A		120A	
<b>Current (CC) Accuracy</b>	0.05%+5μA	0.05%+30μA	0.05%+10μA	0.05%+60μA	0.05%+25μA	0.05%+125μA	
<b>POWER</b>							
<b>Max. Power</b>	>1s	125W		250W		500W	
	100ms	160W		320W		640W	
	10ms	380W	325W	760W	650W	1.5kW	1.3kW
	1ms	1.15kW	950W	2.3kW	1.9kW	4.6kW	3.8kW
	<100μs	3.6kW	2.4kW	7.2kW	4.8kW	14.4kW	9.6kW
<b>Power (CW) Accuracy</b>	0.075%+25μW	0.075%+150μW	0.075%+50μW	0.075%+300μW	0.075%+125μW	0.075%+625μW	
<b>RESISTANCE</b>							
<b>Resistive Loading</b>	42mΩ-900kΩ	90mΩ-900kΩ	21mΩ-700kΩ	45mΩ-700kΩ	10.5mΩ-500kΩ	25mΩ-500kΩ	
<b>Resistive (CR) Accuracy</b>	0.1%						
<b>Capacitive Loading</b>	0.3μF						
<b>LOADING MODES and TIMING</b>							

<b>Loading Modes (Level A and Level B)</b>	Open or Short Basic (CV+CR+CC+CW in any combination), single or arbitrary sequence (up to 100 independent steps) V-I Table Lookup (interpolated, up to 100 points) Linear or logarithmic swept current or power, up to 500 steps, P1->P2 or P1->P2->P1 OCP or OPP Test (automatically terminated current or power sweep)
<b>Loading Timing Modes</b>	Continuous Level A or B (any combination of the above modes) Pulsed A/B (any combination of the above modes except OCP or OPP) Interleaved A/B (any combination of the above modes except OCP or OPP)
<b>Load Timing</b>	Continuous, or 5 $\mu$ s to 10000s pulsed/stepped
<b>Non-linear Loading Bandwidth</b>	Typically >35kHz with ability to reduce bandwidth

See the remainder of this document for full details for each model.

### 1.5.1 Key Features

- Equally capable of generating kW, W, mW or  $\mu$ W loading. >20:1 higher and >1000:1 lower loading capability range than most presently available loads in this price range.
- Fully featured with transient and non-linear loading capabilities and with the additional feature of sweep capability.
- Wide bandwidth non-linear loading modes.
- High-accuracy voltage and current measurements within pulses or sweep steps as short as 20 $\mu$ s.
- Arbitrary loading sequence with up to 100 steps to simulate virtually any “real-world” loading.
- Fully configurable loading rising and falling edge controls, and soft-start capability.
- Excellent transient performance in timing and wave shape, with the ability for the user to view the current and voltage waveforms using the internal scope.
- Fully protected short loading, with automatic current and power limiting.
- Comprehensive self-test assuring that all loading and measurement circuitry is properly functioning.
- Unique historical data logging capability, both graphical and numerical.
- Unique graphical X/Y plotting of V vs I and V vs P characteristics using swept loading.
- Leading accuracy, typically >10:1 better than other units at lower loading levels and >2:1 better at high loading levels, with ISO17025 traceability also available.
- Full-color LCD with touch panel user interface for ease of use.

### 1.5.2 Displayed Results

“Real-time” results: numerically represented measured actual applied voltage and actual loading current, and the computed load power and resistance or conductance.

Pulse results: numerically represented measured actual applied voltage and actual loading current within a pulse, and the computed load power and resistance or conductance.

OCP or OPP result:	numerically represented maximum current and power achieved prior to the voltage dropping below a set voltage.
Battery test:	numerically represented accumulated A.Hr and W.Hr, as accumulated since the operation was started with automatic stop at ending voltage.
Historical data logging:	graphically represented measured actual applied voltage and the actual loading current and the computed load power, with down to 1ms resolution and a long-term maximum.
Oscilloscope:	graphically represented up to 400kSPS sampled applied voltage and loading current.
XY Plot:	graphically represented V vs A/W plot of swept measurement results.

### 1.5.3 Protection

Over Temperature (OTP)	Automatic OTP trip is included that turns off loading when an over-temperature situation exists; this may be cleared by the user after sufficient cooling has occurred.
Over Voltage (OVP)	Automatic OVP trip is included that turns off loading at the specified maximum applied voltage when an over-voltage situation exists; this may be cleared by the user when the voltage is below 90% of the detection limit. User-configured OVP trip is also available at a voltage from 0.1V up to the specified maximum applied voltage.
Over Power (OPP)	Automatic OPP is included at the specified maximum power load limits vs. time. If exceeded, the loading power is automatically limited to that shown for 1s or more and is reset after >150ms at no-loading.
Over Current (OCP)	Automatic OCP is included at the specified maximum current load limits vs. time. If exceeded, the loading current is automatically limited to that shown for 1s or more and is reset after >150ms at no-loading.
Reverse Polarity (RPP)	Diode protected across the terminals.

### 1.5.4 Loading Method

Digitally controlled, unequally weighted, multi-stage, single quadrant current loading with high-speed (200kHz) digital CV, CR and CW feedback.

### 1.5.5 Detailed Loading and Measurement Specifications

All accuracy specifications assume the periodic use of self-test to perform internal circuitry alignment. This interval should be a minimum of once per month, or when the ambient temperature has changed by more than 5 °C.

All time-limited currents and powers are limited if above their respective maximum continuous value for a time T (in seconds) as shown in the specifications below. If exceeded, the current or power is automatically reduced to the maximum continuous level and is reset after time T (in seconds) as calculated in the same manner.

Specifications denoted as “(typ)” are not guaranteed but are typical specifications.

All uses of percentages in these specifications are a percentage of the respective measurement result or setting, unless otherwise stated.

All accuracy specifications are valid as follows:

For one year following calibration.

2 $\sigma$  specifications with a normal distribution.

Apply to all models.

Apply to both loading and readback of the respective quantity.

With 10 minutes of thermal stabilization after an ambient change, and after powering on the unit.

Within an ambient temperature range of 18 °C to 28 °C. Unless otherwise stated, outside of this range, they increase by 7% per °C (e.g., at an ambient temperature T above 28 °C, multiply by  $(1+0.07*(T-28))$ ).

For measurements taken over a period of 10ms or more. The typical accuracy at 1ms is 1.25 times the stated accuracy, and at 100us is 2 times the stated accuracy.

#### 1.5.5.1 Terminal Loading

There is a nominally 0.3 $\mu$ F capacitive loading at all times between the terminals.

#### 1.5.5.2 Voltage Measurement

Voltage Range: Performance not specified for voltage <-6mV  
DL115, DL215 or DL515: -0.1V to 150V  
DL150, DL250 or DL550: -0.1V to 500V  
The measurement range is from -2.5V to +700V for all models, but the unit may be severely damaged by voltages outside of the range stated above.

Ranging: Fully automatic solid-state ranging with minimal disruption to measurements  
25 $\mu$ s per range when up-ranging, and 5ms per range when down-ranging.

Accuracy:  $\pm 0.04\% \pm 1mV$  (add  $\pm 0.01\%$  when using external sensing).

Power Heating Effect: Added for pulse widths >1s or duty cycles >10%:  
DL115 or DL150:  $\pm (0.00004\%*W)$   
DL215 or DL250:  $\pm (0.00002\%*W)$   
DL515 or DL550:  $\pm (0.00001\%*W)$



Resolution: 100 $\mu$ V, limited to user-configurable 3, 4 or 5 significant digits.

### 1.5.5.3 Short Resistance Loading Mode

Loading and Readback: Performance not specified for voltage <1mV  
 Increase values by 1% per °C above 28 °C  
 A is the applied current (in amps)  
 If <30s, since at >50% maximum loading power, then multiply values by 1.5  
 At the front-panel terminals, add 10m $\Omega$  (typ)

DL115:	42m $\Omega$ $\pm$ 2m $\Omega$ $\pm$ (1m $\Omega$ /A)
DL150:	90m $\Omega$ $\pm$ 4m $\Omega$ $\pm$ (2m $\Omega$ /A)
DL215:	21m $\Omega$ $\pm$ 2m $\Omega$ $\pm$ (0.5m $\Omega$ /A)
DL250:	45m $\Omega$ $\pm$ 3m $\Omega$ $\pm$ (1m $\Omega$ /A)
DL515:	10.5m $\Omega$ $\pm$ 2m $\Omega$ $\pm$ (0.25m $\Omega$ /A)
DL550:	25m $\Omega$ $\pm$ 3m $\Omega$ $\pm$ (0.5m $\Omega$ /A)

Settling Time (typ): 10 $\mu$ s

### 1.5.5.4 Open (and Off) Loading Mode

Base Loading: (1.08 $\mu$ A\*V)  $\pm$  1% (included in readback)

Accuracy:	DL115:	$\pm$ 5 $\mu$ A
	DL150:	$\pm$ 30 $\mu$ A
	DL215:	$\pm$ 10 $\mu$ A
	DL250:	$\pm$ 60 $\mu$ A
	DL515:	$\pm$ 20 $\mu$ A
	DL550:	$\pm$ 120 $\mu$ A

### 1.5.5.5 Basic Loading Mode

The basic loading mode combines the CV, CR, CC, and CW loading regions into a single mode, with automatic selection of each region as it is enabled. The method by which the regions are selected is described in another section of this document, but in summary, the region that defines the lowest loading current at an applied voltage is the loading region used at that voltage.



If no region is enabled, then the Basic Loading Mode is the same as the Short Loading Mode.

If the CV region is enabled and  $V < V_{CV}$ , then no region is selected, and the loading current is zero.

If both the CV and CR regions are enabled, then both regions are the same region (CVR).

### 1.5.5.6 General Region Specifications

November 4, 2022

Page 10 of 174

- V-A Bandwidth (typ): Only for the CV, CR, CVR and CW regions  
>35kHz (without considering  $R_{HF}$ )
- V-A Phase Shift (typ): Only for the CV, CR, CVR and CW regions  
2.5° per kHz with current lagging the voltage (without considering  $R_{HF}$ )
- Current 10-90% Settling (typ): DL115 or DL150:  $2.5A/\mu s + (5\mu s * [1 + \{1mA / \text{loading current}\}])$   
add 30 $\mu s$  when changing from <120mA to >120mA  
add  $5\mu s * 0.5A / \text{loading current}$  if >120mA  
DL215 or DL250:  $5A/\mu s + (5\mu s * [1 + \{1mA / \text{loading current}\}])$   
add 30 $\mu s$  when changing from <240mA to >240mA  
add  $5\mu s * 1A / \text{loading current}$  if >240mA  
DL515 or DL550:  $8A/\mu s + (5\mu s * [1 + \{2mA / \text{loading current}\}])$   
add 30 $\mu s$  when changing from <480mA to >480mA  
add  $5\mu s * 2A / \text{loading current}$  if >480mA  
Add  $5\mu s * R_{HF} / R_{CR}$  in the CR or CVR regions  
Add  $5\mu s * R_{HF} / 1m\Omega$  in the CV region

#### 1.5.5.7 Constant Voltage Loading Region (CV)

In this region, the load current is  $A_{CV} = (V - V_{CV}) / (R_{CV} + [R_{HF} * F / 35kHz])$ .

- $A_{CV}$  current loading produced to regulate the voltage
- $V$  applied voltage
- $V_{CV}$  configured CV voltage setting
- $R_{CV}$  1m $\Omega$
- $R_{HF}$  configured high-frequency resistance setting
- $F$  frequency

Voltage Range: Performance not specified for current <500 $\mu A$   
DL115, DL215 or DL515: 0V to 150V  
DL150, DL250 or DL550: 0V to 500V  
The external supply open circuit voltage must not be greater than these maximum voltages; otherwise, the unit can be severely damaged.

Accuracy:  $\pm 0.04\% \pm 1mV$  (add  $\pm 0.01\%$  when using external sensing)  
At rear blades: add (typ) (A \* 1m $\Omega$ ) in V  
At front terminals: add (typ) (A \* 10m $\Omega$ ) in V

Power Heating Effect: Added for pulse widths >1s or duty cycles >10%:  
DL115 or DL150:  $\pm (0.00004\% * W)$   
DL215 or DL250:  $\pm (0.00002\% * W)$   
DL515 or DL550:  $\pm (0.00001\% * W)$

Resolution: Higher of 100 $\mu V$  or 0.001% of setting

**1.5.5.8 Constant Resistance Loading Region (CR)**

Although information is shown below in the units of resistance ( $\Omega$ ), the unit may be user configured to use the units of conductance (S).

Even when not enabled, this region always asserts a maximum limit on any loading current of:

$$A_{CR(MAX)} = V / (R_{SHORT} + (R_{HF} * F / 35kHz))$$

If enabled, in this region the load current is  $A_{CR} = V / (R_{CR} + [R_{HF} * F / 35kHz])$

$A_{CR(MAX)}$	maximum possible current in this region
V	applied voltage
$R_{SHORT}$	short loading mode resistance specified previously
$A_{CR}$	current loading produced to regulate the resistance
$R_{CR}$	configured CR resistance setting
$R_{HF}$	configured high-frequency resistance setting
F	frequency

**Resistance Range:** Performance not specified for current  $<(1.08\mu A * V)$  or voltage  $<10mV$ .  
Increase minimum resistance by 1% per  $^{\circ}C$  above  $28^{\circ}C$ .  
If  $<30s$ , since at  $>50%$  maximum loading power, then multiply minimum resistance values by 1.5.

DL115:	42m $\Omega$ to 900k $\Omega$ (or 1.11 $\mu S$ to 23.8S)
DL150:	90m $\Omega$ to 900k $\Omega$ (or 1.11 $\mu S$ to 11.1S)
DL215:	21m $\Omega$ to 700k $\Omega$ (or 1.43 $\mu S$ to 47.6S)
DL250:	45m $\Omega$ to 700k $\Omega$ (or 1.43 $\mu S$ to 22.2S)
DL515:	10.5m $\Omega$ to 500k $\Omega$ (or 2 $\mu S$ to 95.2S)
DL550:	25m $\Omega$ to 500k $\Omega$ (or 2 $\mu S$ to 40S)

<b>Accuracy:</b>	DL115:	$\pm 0.1\% \pm (0.1\% / V) \pm (0.0005\% / A_{CR})$
	DL150:	$\pm 0.1\% \pm (0.1\% / V) \pm (0.003\% / A_{CR})$
	DL215:	$\pm 0.1\% \pm (0.1\% / V) \pm (0.001\% / A_{CR})$
	DL250:	$\pm 0.1\% \pm (0.1\% / V) \pm (0.006\% / A_{CR})$
	DL515:	$\pm 0.1\% \pm (0.1\% / V) \pm (0.002\% / A_{CR})$
	DL550:	$\pm 0.1\% \pm (0.1\% / V) \pm (0.012\% / A_{CR})$
	At rear blades:	add 1m $\Omega$ (typ)
	At front terminals:	add 10m $\Omega$ (typ)

**Current Heating Effect:** Added for pulse widths  $>10ms$  or duty cycles  $>10\%$ :

DL115 or DL150:	$\pm (0.0001\% * A^2)$
DL215 or DL250:	$\pm (0.000025\% * A^2)$
DL515 or DL550:	$\pm (0.00001\% * A^2)$

**Power Heating Effect:** Added for pulse widths  $>1s$  or duty cycles  $>10\%$ :

DL115 or DL150:	$\pm (0.0004\% * W)$
-----------------	----------------------

DL215 or DL250:  $\pm (0.0002\% * W)$ DL515 or DL550:  $\pm (0.0001\% * W)$ 

Resolution: Resistance: Higher of  $10\mu\Omega$  or 0.001% of setting  
 Conductance: Higher of  $0.01\mu S$  or 0.001% of setting

### 1.5.5.9 Constant Voltage/Resistance Loading Region (CVR)

Although information is shown below in the units of resistance ( $\Omega$ ), the unit may be user-configured to use the units of conductance (S)

If enabled, in this region the load current is the lower of  $A_{CVR} = (V - V_{CV}) / (R_{CR} + [R_{HF} * F / 35kHz])$  or  $(V / [R_{SHORT} + \{R_{HF} * F / 35kHz\}])$ .

$A_{CVR}$  current loading produced to regulate the voltage and resistance  
 V applied voltage  
 $V_{CV}$  configured CV voltage setting  
 $R_{CR}$  configured CR resistance setting  
 $R_{HF}$  configured high frequency resistance setting  
 F frequency  
 $R_{SHORT}$  the short loading mode resistance specified previously

Voltage Range ( $V_{CV}$ ): Performance not specified for current  $<500\mu A$  and  $<(1.08\mu A * V)$ , or for voltage  $<1mV$

DL115, DL215 or DL515: 0V to 150V

DL150, DL250 or DL550: 0V to 500V

The external supply open-circuit voltage must not be greater than these maximum voltages; otherwise, the unit can be severely damaged.

Resistance Range ( $R_{CR}$ ): Performance not specified for current  $<500\mu A$  and  $<(1.08\mu A * V)$  or for voltage  $<1mV$

DL115 or DL150:  $1m\Omega$  to  $900k\Omega$  (or  $1.11\mu S$  to  $1000S$ )DL215 or DL250:  $1m\Omega$  to  $700k\Omega$  (or  $1.43\mu S$  to  $1000S$ )DL515 or DL550:  $1m\Omega$  to  $500k\Omega$  (or  $2\mu S$  to  $1000S$ )

Accuracy: If the  $R_{SHORT}$  based limit is being applied, then resistance is as for the Short Loading Mode; otherwise, as below.

Accuracy of current at a voltage V:

DL115:  $\pm 0.05\% \pm (5\mu A \text{ below } 120mA \text{ or } 40\mu A \text{ above } 120mA) \pm ((0.04\% \text{ of } V + 1mV) / R_{CR})$ DL150:  $\pm 0.05\% \pm (30\mu A \text{ below } 120mA \text{ or } 65\mu A \text{ above } 120mA) \pm ((0.04\% \text{ of } V + 1mV) / R_{CR})$ DL215:  $\pm 0.05\% \pm (10\mu A \text{ below } 240mA \text{ or } 75\mu A \text{ above } 240mA) \pm ((0.04\% \text{ of } V + 1mV) / R_{CR})$ DL250:  $\pm 0.05\% \pm (60\mu A \text{ below } 240mA \text{ or } 125\mu A \text{ above } 240mA) \pm$

$$((0.04\% \text{ of } V + 1\text{mV}) / R_{CR})$$

$$\text{DL515: } \pm 0.05\% \pm (20\mu\text{A below } 480\text{mA or } 150\mu\text{A above } 480\text{mA}) \pm ((0.04\% \text{ of } V + 1\text{mV}) / R_{CR})$$

$$\text{DL550: } \pm 0.05\% \pm (120\mu\text{A below } 480\text{mA or } 250\mu\text{A above } 480\text{mA}) \pm ((0.04\% \text{ of } V + 1\text{mV}) / R_{CR})$$

At the rear blades, add  $(100\% * 1\text{m}\Omega / (1\text{m}\Omega + R_{CR}))$  (typ)

At the front panel terminals, add  $(100\% * 10\text{m}\Omega / (10\text{m}\Omega + R_{CR}))$  (typ)

Accuracy of voltage at a current A

$$\text{DL115: } \pm 0.05\% \pm 1\text{mV} \pm (R_{CR} * (0.05\% \text{ of } A + (5\mu\text{A below } 120\text{mA or } 40\mu\text{A above } 120\text{mA})))$$

$$\text{DL150: } \pm 0.05\% \pm 1\text{mV} \pm (R_{CR} * (0.05\% \text{ of } A + (30\mu\text{A below } 120\text{mA or } 65\mu\text{A above } 120\text{mA})))$$

$$\text{DL215: } \pm 0.05\% \pm 1\text{mV} \pm (R_{CR} * (0.05\% \text{ of } A + (10\mu\text{A below } 240\text{mA or } 75\mu\text{A above } 240\text{mA})))$$

$$\text{DL250: } \pm 0.05\% \pm 1\text{mV} \pm (R_{CR} * (0.05\% \text{ of } A + (60\mu\text{A below } 240\text{mA or } 125\mu\text{A above } 240\text{mA})))$$

$$\text{DL515: } \pm 0.05\% \pm 1\text{mV} \pm (R_{CR} * (0.05\% \text{ of } A + (20\mu\text{A below } 480\text{mA or } 150\mu\text{A above } 480\text{mA})))$$

$$\text{DL550: } \pm 0.05\% \pm 1\text{mV} \pm (R_{CR} * (0.05\% \text{ of } A + (120\mu\text{A below } 480\text{mA or } 250\mu\text{A above } 480\text{mA})))$$

At the rear blades, add  $(A * 1\text{m}\Omega)$  in V (typ)

At the front panel terminals, add  $(A * 10\text{m}\Omega)$  in V (typ)

Current Heating Effect: Added as a percentage of current for pulse widths >10ms, or duty cycles >10%:

$$\text{DL115 or DL150: } \pm (0.0001\% * A^2)$$

$$\text{DL215 or DL250: } \pm (0.000025\% * A^2)$$

$$\text{DL515 or DL550: } \pm (0.00001\% * A^2)$$

Power Heating Effect: Added as a percentage of current or voltage for pulse widths >1s, or duty cycles >10%:

$$\text{DL115 or DL150: } \pm (0.0004\% * W)$$

$$\text{DL215 or DL250: } \pm (0.0002\% * W)$$

$$\text{DL515 or DL550: } \pm (0.0001\% * W)$$

Resolution:  
 Resistance: Higher of  $10\mu\Omega$  or 0.001% of setting  
 Conductance: Higher of  $0.01\mu\text{S}$  or 0.001% of setting  
 Voltage: Higher of  $100\mu\text{V}$  or 0.001% of setting

#### 1.5.5.10 Constant Current Loading Region (CC)

Even when not enabled, this region always asserts a maximum limit on any loading current of  $A_{CC(MAX)}$ .  
 If enabled, in this region the load current is the lower of  $A_{CC}$  or  $A_{CC(MAX)}$ .

$A_{CC(MAX)}$  maximum possible current in this region, with time limits and terminal limits applied as needed.

$A_{CC}$  configured CC current setting.

Current Range:	Performance not specified for current $<(1.08\mu A * V)$ or voltage $<10mV$	
	DL115 or DL150:	0 to 30A (21A continuous)
	DL215 or DL250:	0 to 60A (42A continuous), limited to 50A (30A continuous) at the front terminals
	DL515 or DL550:	0 to 120A (84A continuous), limited to 50A (30A continuous) at the front terminals
Rear Blade Time Limit:	DL115 or DL150:	$T = 50 /  A^2 - 21^2 $ (e.g., 108ms at 30A, reset in 168ms at 12A)
	DL215 or DL250:	$T = 200 /  A^2 - 42^2 $ (e.g., 108ms at 60A, reset in 168ms at 24A)
	DL515 or DL550:	$T = 800 /  A^2 - 84^2 $ (e.g., 108ms at 120A, reset in 168ms at 48A)
Front Terminal Time Limit:	DL115 or DL150:	Same as rear blade time limit (above)
	DL215, DL250:	$T = 160 /  A^2 - 30^2 $ (e.g., 100ms at 50A, reset in 200ms at 10A)
	DL515, DL550:	$T = 200 /  A^2 - 30^2 $ (e.g., 100ms at 50A, reset in 200ms at 10A)
Accuracy:	DL115:	$\pm 0.05\% \pm (5\mu A \text{ below } 120mA \text{ or } 40\mu A \text{ above } 120mA)$
	DL150:	$\pm 0.05\% \pm (30\mu A \text{ below } 120mA \text{ or } 65\mu A \text{ above } 120mA)$
	DL215:	$\pm 0.05\% \pm (10\mu A \text{ below } 240mA \text{ or } 75\mu A \text{ above } 240mA)$
	DL250:	$\pm 0.05\% \pm (60\mu A \text{ below } 240mA \text{ or } 125\mu A \text{ above } 240mA)$
	DL515:	$\pm 0.05\% \pm (20\mu A \text{ below } 480mA \text{ or } 150\mu A \text{ above } 480mA)$
	DL550:	$\pm 0.05\% \pm (120\mu A \text{ below } 480mA \text{ or } 250\mu A \text{ above } 480mA)$
Current Heating Effect:	Added for pulse widths $>10ms$ or duty cycles $>10\%$ :	
	DL115 or DL150:	$\pm (0.0001\% * A^2)$
	DL215 or DL250:	$\pm (0.000025\% * A^2)$
	DL515 or DL550:	$\pm (0.00001\% * A^2)$
Power Heating Effect:	Added for pulse widths $>1s$ or duty cycles $>10\%$ :	
	DL115 or DL150:	$\pm (0.0004\% * W)$
	DL215 or DL250:	$\pm (0.0002\% * W)$
	DL515 or DL550:	$\pm (0.0001\% * W)$
Loading Resolution:	Higher of $1\mu A$ or $0.001\%$ of setting.	
Readback Resolution:	$1\mu A$ , limited to user-configurable 3, 4 or 5 significant digits.	
Overshoot (typ):	$<(2\% + 1mA)$	

#### 1.5.5.11 Constant Power Loading Region (CW)

Even when not enabled, this region always asserts a maximum limit on any loading power of  $W_{CW(MAX)}$ . If enabled, in this region the loading power is the lower of  $W_{CW}$  or  $W_{CW(MAX)}$  and the loading current is this divided by the voltage.

$W_{CW(MAX)}$	maximum possible power in this region with time limits and terminal limits applied as needed
$W_{CW}$	configured CW power setting
Power Range:	Performance not specified for current $<(1.08\mu A * V)$ or voltage $<10mV$ DL115: 0 to 3.625kW (125W continuous) DL150: 0 to 2.4kW (125W continuous) DL215: 0 to 7.25kW (250W continuous) DL150: 0 to 4.8kW (250W continuous) DL515: 0 to 14.5kW (500W continuous) DL550: 0 to 9.6kW (500W continuous)
Time Limit:	DL115: $T = 1300 /  W^2 - 125^2 $ (e.g. 1.96ms at 1kW, reset in 96ms at no power) DL150: $T = 900 /  W^2 - 125^2 $ (e.g. 1.96ms at 1kW, reset in 96ms at no power) DL215: $T = 5200 /  W^2 - 250^2 $ (e.g. 1.96ms at 2kW, reset in 96ms at no power) DL250: $T = 3600 /  W^2 - 250^2 $ (e.g. 1.96ms at 2kW, reset in 96ms at no power) DL515: $T = 20800 /  W^2 - 500^2 $ (e.g. 1.96ms at 4kW, reset in 96ms at no power) DL550: $T = 14400 /  W^2 - 500^2 $ (e.g. 1.96ms at 4kW, reset in 96ms at no power)
Accuracy:	DL115: $\pm 0.075\% \pm (V * 5\mu A) \pm (A * 1mV)$ (add $V * 35\mu A$ if $A > 120mA$ ) DL150: $\pm 0.075\% \pm (V * 30\mu A) \pm (A * 1mV)$ (add $V * 35\mu A$ if $A > 120mA$ ) DL215: $\pm 0.075\% \pm (V * 10\mu A) \pm (A * 1mV)$ (add $V * 65\mu A$ if $A > 240mA$ ) DL250: $\pm 0.075\% \pm (V * 60\mu A) \pm (A * 1mV)$ (add $V * 65\mu A$ if $A > 240mA$ ) DL515: $\pm 0.075\% \pm (V * 20\mu A) \pm (A * 1mV)$ (add $V * 130\mu A$ if $A > 480mA$ ) DL550: $\pm 0.075\% \pm (V * 120\mu A) \pm (A * 1mV)$ (add $V * 130\mu A$ if $A > 480mA$ )
Current Heating Effect:	Added for pulse widths $>10ms$ or duty cycles $>10\%$ : DL115 or DL150: $\pm (0.0001\% * A^2)$

	DL215 or DL250:	$\pm (0.000025\% \cdot A^2)$
	DL515 or DL550:	$\pm (0.00001\% \cdot A^2)$
Power Heating Effect:	Added for pulse widths >1s or duty cycles >10%:	
	DL115 or DL150:	$\pm (0.0004\% \cdot W)$
	DL215 or DL250:	$\pm (0.0002\% \cdot W)$
	DL515 or DL550:	$\pm (0.0001\% \cdot W)$
Loading Resolution:	Higher of 1 $\mu$ W or 0.001% of setting	
Readback Resolution:	0.1 $\mu$ W, limited to user-configurable 3, 4 or 5 significant digits.	

### 1.5.5.12 Arbitrary Loading

This provides a sequence of independent Basic Loading Modes.

Loading Specifications: As Basic Loading Mode for each step, plus open and short

Number of steps: Up to 100 independent basic mode (CV/CR/CC/CW) loadings, each with an independently configured time to maintain that loading.

Step Timing: Each step has an independently configured time to maintain the loading, which may be from 5 $\mu$ s through 10000s or may be configured to be manually timed.

Measurements: If the time configured for an arbitrary loading step is  $\geq 20\mu$ s, then measurements of voltage and current are performed in the shorter of the last 25% or the last 100ms of the step. If an arbitrary loading step is configured to be manually timed, the user has the option whether to perform the measurements when continuing to the next step.

### 1.5.5.13 V-I Table Lookup Loading

Provides a single loading as a variant of the Basic Loading Mode, which has a modified CVR region.

Where  $V[0]$  is the configured zero current voltage

$A[0]$  is 0

$V[n]$  is the  $n^{\text{th}}$  point configured voltage ( $n = 1$  to  $N$ )

$A[n]$  is the  $n^{\text{th}}$  point configured current ( $n = 1$  to  $N$ )

“ $n$ ” is selected as  $V[n] \leq V < V[n+1]$  for  $0 \leq n < N$ , and the regions are set as follows:

CVR region:  $R_{CR} = (V[n+1] - V[n]) / (A[n+1] - A[n])$   
 $V_{CV} = V[n]$   
 $A[n]$  is added to the loading current  
 $R_{HF}$  is ignored

CC region: disabled

CW region:  $W_{CW} =$  the configured maximum power



- Loading Specifications: As Basic Loading Mode (CVR region) with parameters set as described above. Ignore polarity of  $R_{CR}$  when determining accuracy.
- Table Lookup Delay:  $<0.1\mu s$
- Number of Points: Up to 100 V-I data pairs, plus a zero-current voltage point.
- Restrictions:
- a) Points must be ordered from the lowest voltage through the highest voltage and all points must be above the configured zero current voltage  $V[0]$  (which cannot be negative).
  - b) No point may specify a voltage within 0.001% of that in another point.
  - c) The maximum slope of current between any two points is  $\pm 1000A$  per V.

#### 1.5.5.14 Swept Current or Power Loading

Provides a sequence of Basic Loading Modes, each with the regions set as follows:

- CV region: disabled
- CR region: disabled
- CC region: if sweeping power then disabled; otherwise, enabled with  $A_{CC}$  set to the required loading current for each step.
- CW region: if sweeping current then disabled; otherwise, enabled with  $W_{CW}$  set to the required loading power for each step.

#### NOTE

The user can only enter up to 500 steps.

- Number of steps: For a single direction sweep (P1 -> P2):  $\leq 502$  total steps  
For a dual direction sweep (P1 -> P2 -> P1):  $\leq 1003$  total steps
- Restrictions:
- a) For a logarithmic sweep, neither P1 or P2 may be zero.
  - b) For any sweep, neither P1 or P2 may be negative.
  - c) For a logarithmic sweep, P1/P2 must be either  $<0.99999$  or  $>1.00001$ .
- Step Timing: All steps in a sweep are of the same width, which may be configured between  $5\mu s$  to 10000s, or all steps may be configured to be manually timed.
- Measurements: If the time configured for each step is  $\geq 20\mu s$ , measurements of voltage and current are performed in the shorter of the last 25%, or the last 100ms of the step. If steps are configured to be manually timed, the user has the option whether to perform the measurements when continuing to the next step. Power, resistance, and conductance are calculated from these measurements.

#### 1.5.5.15 OCP or OPP Test Loading

Performed in the same manner as a linear, single-direction sweep. If the applied voltage falls below the user-configured level, the sweep is aborted, and the highest current and highest power measurement

obtained during the sweep at which the voltage remained above the configured level are also made available. The OCP/OPP sweep is considered **Failed** if it reaches the configured maximum or does not exceed a configured minimum.

#### 1.5.5.16 Pulsed Measurements

Pulsed measurements are provided for pulsed loading modes which do not contain steps and are made in a manner similar to measurements performed within each step of a swept or arbitrary loading mode as described above.

---

### 1.6 Loading Level Selection

---

There are two independently configurable loading levels (A and B), each of which can have any of the available loading modes listed above. The user can choose for the unit to automatically perform the following selections of these levels:

- Continuous A or B:        Continuously applies one of the levels.  
                                  If the level is a stepped loading, the sequence is repeated continuously.  
                                  The user can manually switch between levels while actively loading.
- Pulsed:                        Automatically pulses between the levels alternately.  
                                  The user can configure for a time at each level (if not an arbitrary or a swept loading), or the time at the level is one complete action of an arbitrary or swept level.  
                                  Neither loading level can use the OCP/OPP or Battery modes.  
                                  This level can be configured to automatically turn off after a user-configurable number of pulses.
- Interleaved:                Automatically pulses each level alternately; however, unlike for the pulsed loading above, it does so for each step in an arbitrary or swept level.  
                                  The user can configure for a time at each level (if not an arbitrary or a swept loading), or the time at the level is one step of an arbitrary or swept level.  
                                  Neither loading level can use the OCP/OPP or Battery modes.  
                                  This level can be configured to automatically turn off after a user-configurable number of interleaves.

---

### 1.7 User Loading Timing Limits

---

The user can configure the following restrictions to loading timing, which is applied to all loading modes except Open and Short:

- Change of load current: Separate user-configured limits apply to each direction of change:
- |                |                      |
|----------------|----------------------|
| Slew Limit:    | 1mA/s to 5A/ $\mu$ s |
| Time Constant: | 5 $\mu$ s to 10ms    |

Soft Start: User-configured voltage detection level and start-up ramp time.  
Automatically reset at below 50% of the configured voltage detection level.

---

## 1.8 Loading Timing Accuracy

---

All automatically generated timings are typically within  $\pm 2.5\mu\text{s} \pm 0.01\%$  of that configured.

The maximum delay between a commanded change in loading to the actual change (to the 50% of change point) is  $20\mu\text{s} +$  any user limit on the load response.

---

## 1.9 Oscilloscope

---

Sampling Rate:	400kSPS
Sampling Resolution:	16 bits
Accuracy:	As relevant voltage or current measurement accuracy
Trigger Source:	User-configurable rising/falling detection of voltage or current or synchronous triggers to loading activities or free-running
Timebase:	1/2/5 settings from 10 $\mu\text{s}/\text{div}$ to 2s/div
Signal Delays (typ):	Voltage-to-Current relative delay: $<\pm 10\mu\text{s}$ Synchronous Trigger to Voltage/Current: $<10\mu\text{s}$
Bandwidth (typ):	Voltage: 300kHz with no user-restricted bandwidth Current: 150kHz with no user-restricted bandwidth User-configurable bandwidth limit between 1kHz and 1000kHz, or none.
Noise (typ):	Voltage: 0.1% of level + 1mV peak with no user-restricted bandwidth Voltage: 0.02% of level + 200 $\mu\text{V}$ peak with 10kHz user-restricted bandwidth Current: 0.5% of level + 20 $\mu\text{A}$ peak with no user-restricted bandwidth Current: 0.1% of level + 5 $\mu\text{A}$ peak with 10kHz user-restricted bandwidth

---

## 1.10 Parallel Operation

---

Multiple units may be used in parallel for static higher current loading (cannot be used with CV or CR regions enabled or non-static loading modes).

---

## 1.11 Interfaces

---

The following interfaces are provided:

- LAN (LXI certified).
- USB Device (CDC – communications class); full-speed.
- USB Host (front panel). Full-speed, supports external USB drive only.
- Digital I/O.

---

## 1.12 Physical

---

Size:	5 in. high x 8.5 in. wide x 13 in. deep).
Weight:	Approx. 8 lb. (unpacked, without external power supply).
Power:	External 12 VDC, 60 VA power brick
Display:	5 in. diagonal, 800 x 480 pixel color LCD with touch screen.
Adjustment Wheel:	Indented encoder provided on front panel allowing for “live” adjustment of the loading levels or timings.
Rack Mounting:	Rack mount kits available for mounting one or two units in a 19 in.-wide rack.
Terminals:	Front: Sheathed banana 4mm sockets, suitable for up to 30A continuous loading. Rear: Approx. 1 in. square x 0.06 in. blade-type terminals (fully specified). Safety cover provided. Voltage Sense: Wire entry sprung sockets in rear panel.

---

## 1.13 Environmental

---

Warm-Up Time:	Operational: 20 seconds Specifications: 15 minutes
Temperature:	Operating: 0 °C to +40 °C, at 10% to 80% RH (non-condensing). Automatically reduces loading if overheating detected. Storage: -20 °C to +70 °C, at 5% to 95% RH (non-condensing).
Altitude:	0 to 2000m ASL
Cooling:	Variable-speed forced air. Intake vents on both sides and on the bottom, exhaust vents in the rear. Specifications valid with any one set of vents impeded. At least 6 in. of clear space must be provided behind the rear panel and around at least two of the sets of intake vents.

---

## 1.14 Certification

---

EMC:	All applicable EMC standards for non-residential use.
Safety:	EN61010-1 (uncategorized <500 VDC, or peak for any terminal to ground for any model).
LXI:	LAN is LXI certified.

## 2 Getting Started

### 2.1 Unpacking and Inspection

After the DL has been shipped or otherwise handled in an unknown manner, the user should visually inspect the instrument for damage before attempting to operate it. **Particular attention should be given to ensure that there are no significant dents or cracks on any outer surfaces, no marks, or scratches on the front panel LCD touch screen, and that all terminals are securely mounted on the unit.** If any significant dents or any loosely mounted terminals are noted, it is recommended that the DL be serviced prior to being placed into use, as safety may have been compromised.

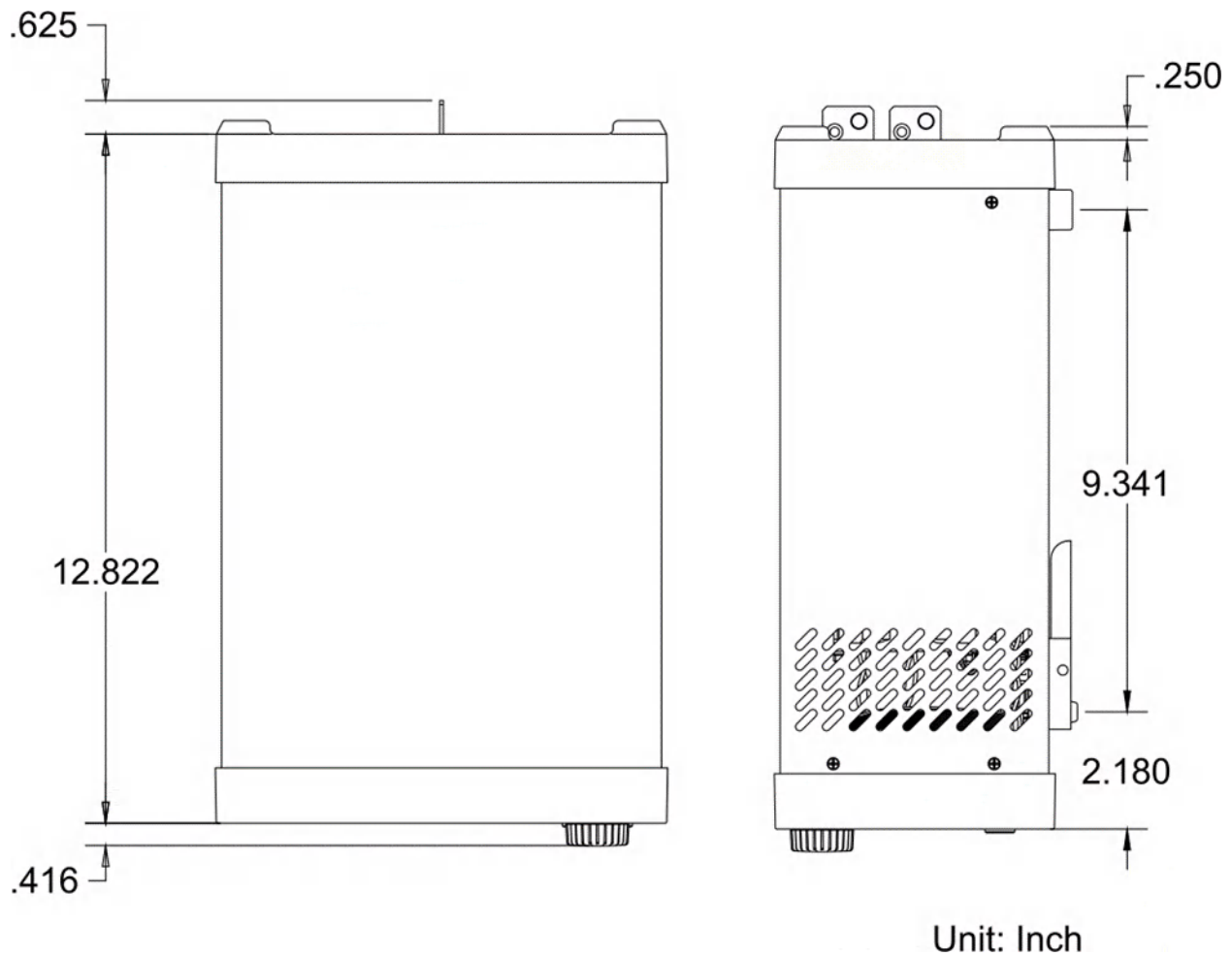

Figure 2-1 Side Dimensions of the DL

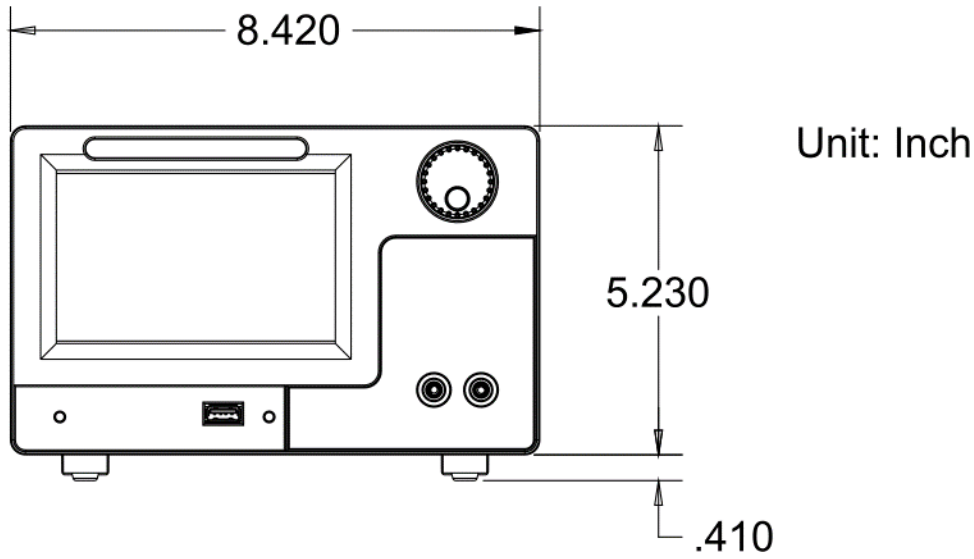
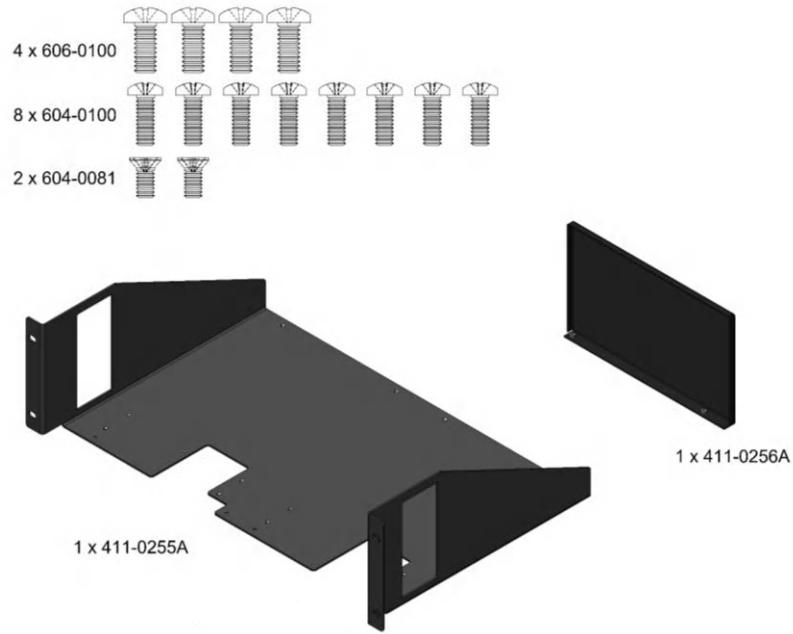

Figure 2-2 Front Dimensions of DL

## 2.2 Rack Mount Installation



Vitretek P/N: 597-5025

ACCESSORY, RM-DL RACK MOUNT KIT

**Supplied Part List (Parts not sold separately):**

Vitretek P/N	Description	QTY
411-0255A	DL Series Rack Mount Tray	1
411-0256A	DL Series Rack Mount Blanking Plate	1
606-0100	#6-32 x 5/16 in Phillips Pan Head Screw	4
604-0100	#4-40 x 5/16 in Phillips Pan Head Screw	8
604-0081	#4-40 x 1/4 in Phillips Flat Head Screw	2

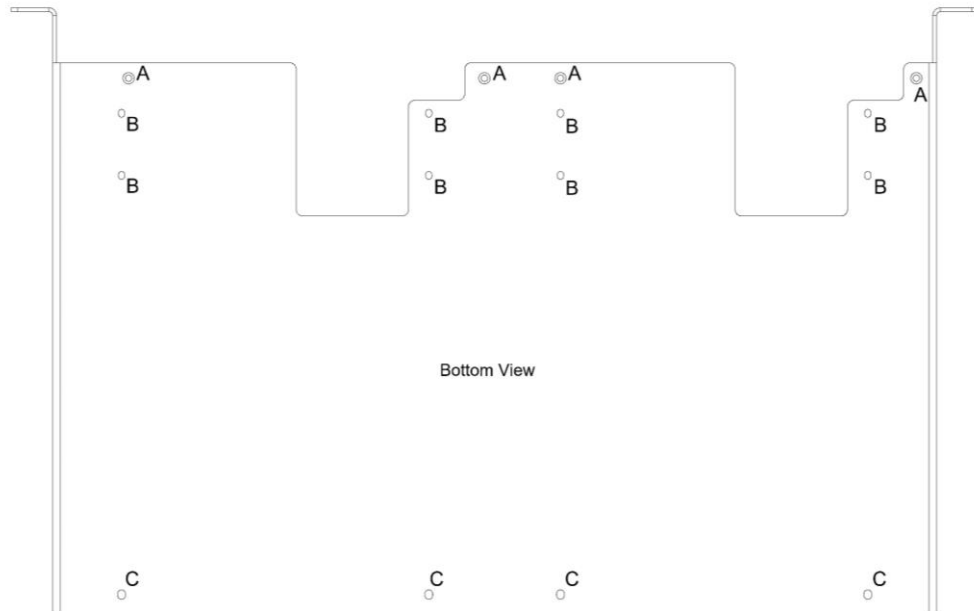

Recommended Fasteners:

- |  |                                  |
|--|----------------------------------|
| A: Mounting Holes for Blanking Plate     | (#4-40 x 1/4 in Flat Head Screw) |
| B: Front Mounting Holes for DC Load Unit | (#4-40 x 5/16 in Pan Head Screw) |
| C: Rear Mounting Holes for DC Load Unit  | (#6-32 x 5/16 in Pan Head Screw) |

Warning: Disconnect the instrument from all voltage sources before fitting to the rack.

1. Turn the unit upside down, remove the two rubber cushions on the front feet using a flat head screwdriver
2. Remove all the feet from the unit.

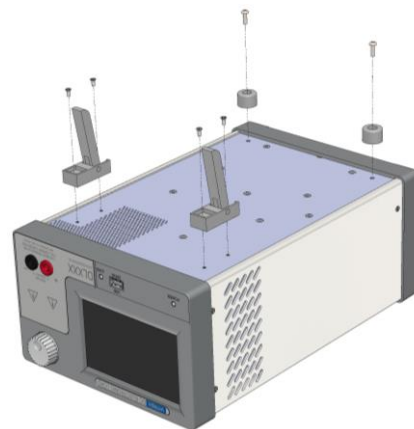

3. Install the unit on one side of the rack using:
  - a. 4 x (#4-40 x 5/16") Phillips pan head screws at the front
  - b. 2 x (#6-32 x 5/16") pan head screws at the rear

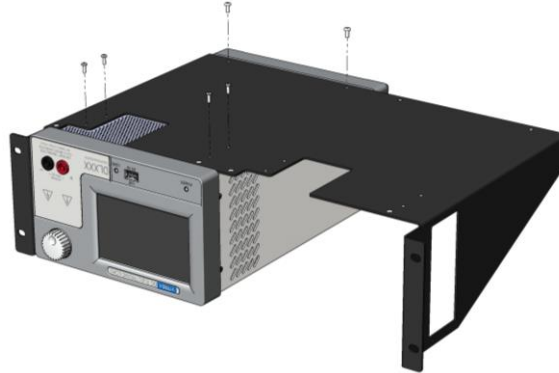

4. Repeat step 1-3 to install the second unit.
5. Install the optional blanking plate for a half rack assembly using 2 x (#4-40 x 1/4 in) flat head screw. (Note: Single unit and blanking plate can be installed on either side of the rack tray).

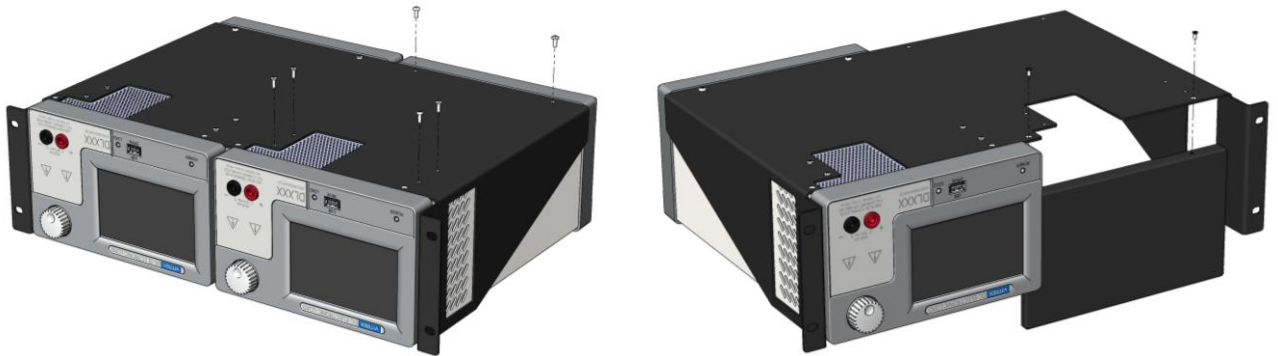

6. Turn over the tray and fit the assembly to the rack enclosure.  
Note: Please store all the extra parts (Rubber Cushions, Feet, Screw, and Blanking Plate (if not used)) in a safe location for later retrieval.

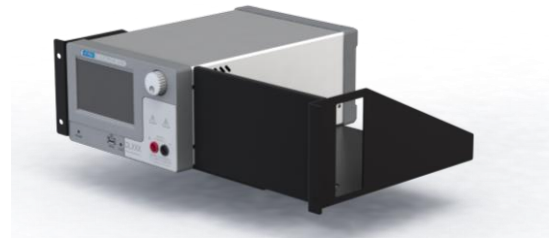



## 2.3 Update the firmware

For best operation it is recommended that you make sure the latest firmware is installed. Power on the DL and navigate to the System->About screen:



Observe the firmware version highlighted above. Use a web browser and visit <https://vitrek.com/dl-series-electronic-dc-load/>, select View Downloads, click on Downloads, and determine what firmware is available:



To update download the file – it is a zip – and extract it to a flash stick, insert the flash stick in the DL, proceed to section 5.3.1.1 for instructions on the user experience.

## 2.4 Periodic Maintenance

The DL Series requires minimal periodic maintenance.

It is recommended that the Self-Test function be run at regular intervals. See section 5.3.4 for more information.

Clean the instrument regularly according to its operating conditions.

1. Disconnect the instrument from all power sources.
2. Clean the external surfaces of the instrument with a soft cloth dampened with mild detergent or water if necessary. When cleaning the LCD, take care to avoid scratching the surface of the panel. Ensure no surfaces are damp when reconnecting power to the instrument.
3. Ensure all vents are clear of dirt, dust, or debris.

Refer to section 10.1 for information on the schedule for calibration and procedures.

## 2.5 DL Series Front and Rear Panel Overview

The DL Series are fully featured DC Electronic Load that is capable of providing transient and non-linear loading, fully configurable loading, rising and falling edge controls, and soft-start capability. A full-color LCD with touch panel user interface is utilized for viewing results and configuring the instrument for various loads.

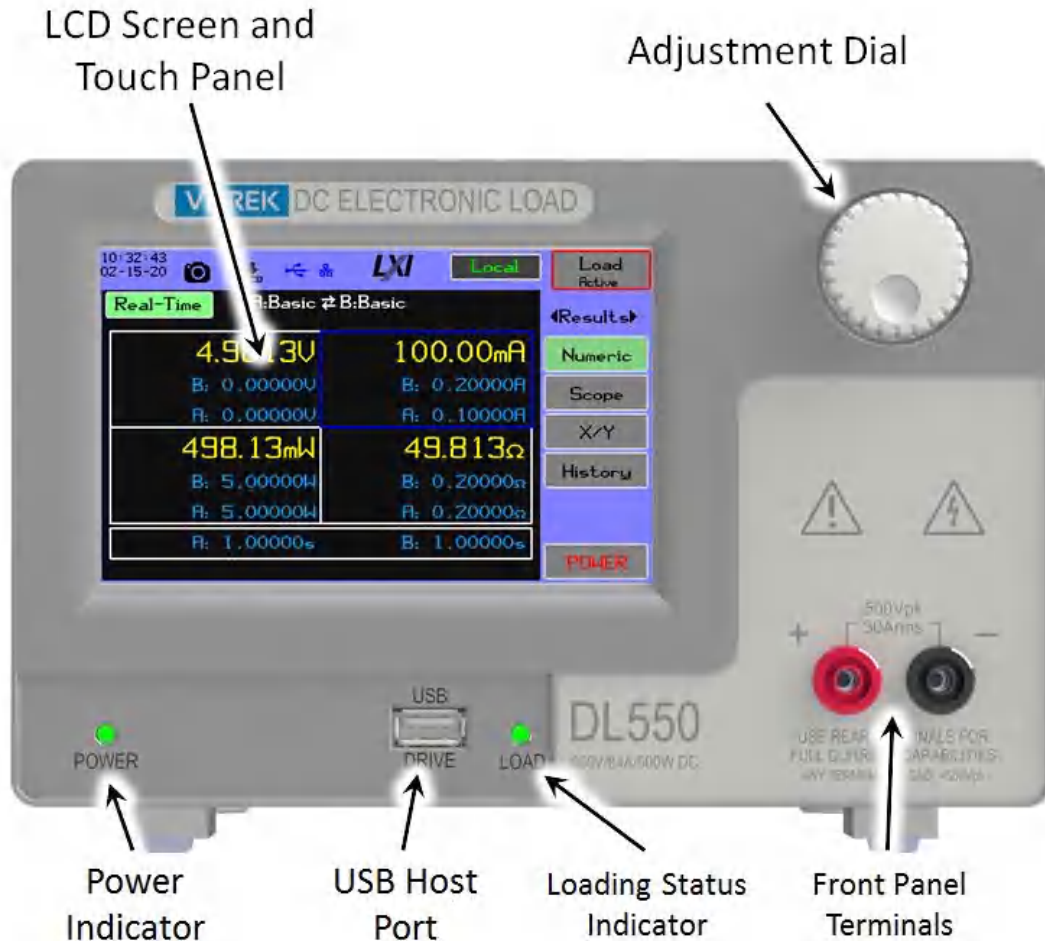
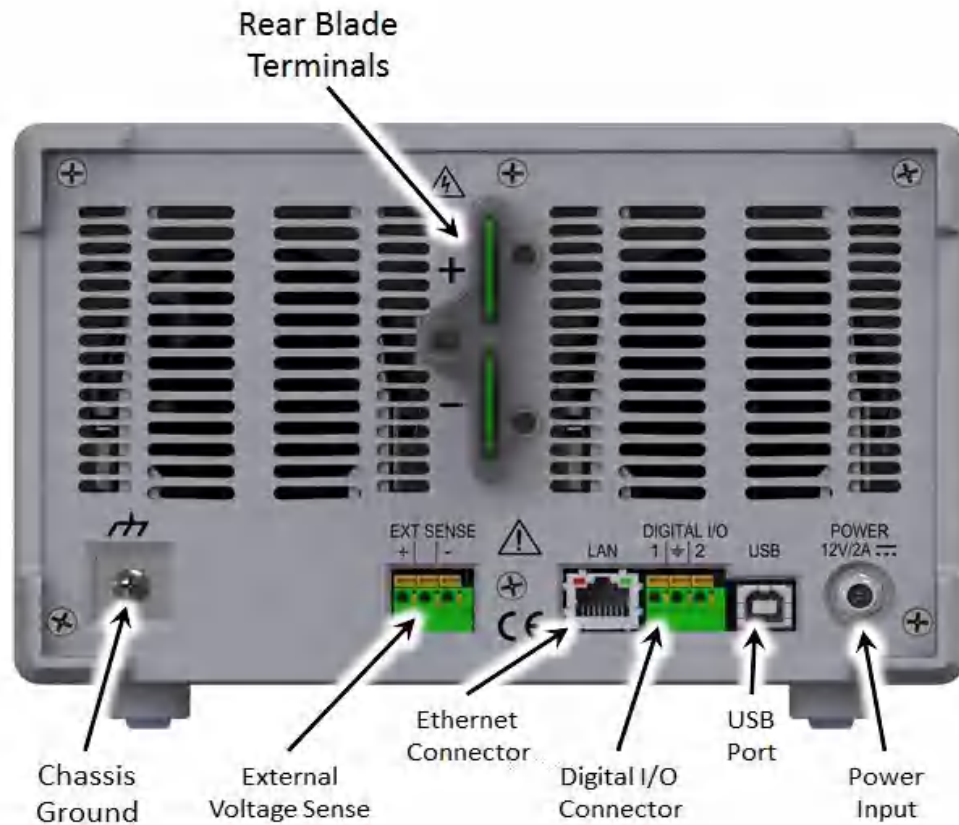

**Figure 2-3 Front Panel Overview**

The front panel of the DL Series, as shown in Figure 2-3 Front Panel Overview, has the following functions:

- LCD Screen and Touch Panel – 5 in. diagonal, 800 x 480 pixel color LCD with touch screen. Used to turn on the unit by pressing briefly, display results and configure settings for the instrument.
- Adjustment Dial – Allows fine adjustments of load settings from the numerical result displays; used for cursor and zoom in the history and scope charts.

- Power Indicator – Indicates if the unit is receiving power. The Power Indicator displays status as follows:
  - OFF: No Power Applied
  - RED: Power Applied, DL Off
  - Dim Green: DL On
  - GREEN: DL On, Touch Activity
- USB Host Port – Full-speed, supports external USB drive only.
- Loading Status Indicator – Indicator for whether load is active on the unit.
  - Off: Loading Inactive
  - Green: Loading Active
  - Flashing Green: Armed
  - Orange: Critical Fault
- Front Panel Terminals – Standard 4 mm safety banana connectors for loading. Limited to 30 amps.



**Figure 2-4 Rear Panel Overview**

The rear panel of the DL Series, as shown Figure 2-4 Rear Panel Overview in has the following functions:

- Terminals – Approx. 1 in.-square x 0.06 in. blade-type terminals (fully specified). Safety cover provided.

- Chassis Grounding
- External Voltage Sense
- Digital I/O
- LAN Port – LAN (LXI certified)
- USB Device Port (CDC – communications class); full-speed
- Power Connector – External 12 VDC, 60 VA power brick. 2.1mm connector, center positive

---

## 2.6 Powering on

---

- 1) Applying power to the DL – Attach the power supply to the power connector on the rear panel of the DL and tighten the screw connector.



**CAUTION**

Do not use a pen, pencil, screwdriver, or any sharp object when using the DLXX Touch Screen.



**NOTE**

If the DL has been configured to turn on when power is applied, skip to step 3.

- 2) Use your fingertip or a stylus to turn on the DL by pressing anywhere on the front panel screen for at least ½ a second.



**NOTE**

If the unit is not calibrated, after initialization the instrument will display the following message: Calibration Warning – calibration required illustrated in section 10.1.

- 3) The unit will display the welcome screen while loading the operating software into memory. When this is complete, a series of initialization steps is performed as shown in Figure 2-5 Initialization Screen.
- 4) When the initialization completes, the system proceeds to the most recently used and available measurement results screen.

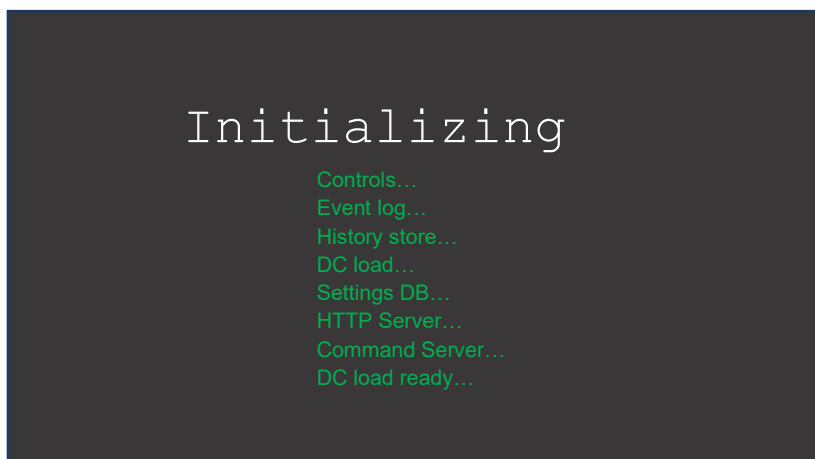

**Figure 2-5 Initialization Screen**

---

## 2.7 Power Off

---



### CAUTION

Unless it is unavoidable, do not power down the DL by removing the source of mains power – especially if loading is active and voltage is applied to the terminals.

It is recommended that the applied voltage be removed from the DL prior to powering down.



### NOTE

The DL may delay powering down if it still has unsaved data. This is typically less than one second.

If the unit was hot due to high power, the display will blank, but the fans may continue running for up to 75 seconds.

- 1) Press and hold the POWER button at the lower right corner of the DL screen. This button must be pressed for at least ½ second to power down the unit. If the unit is actively loading, the user will be prompted to turn loading off; the unit will not turn off if loading is active.

### 3 Theory of Operation

The DL Series unit is a programmable DC load intended to test and verify the performance of sources of DC power. By design, it is easy to perform simple loading functions and may be more complicated to perform complex loading functions. The loading hierarchy is shown in Figure 3-1 Loading Hierarchy.

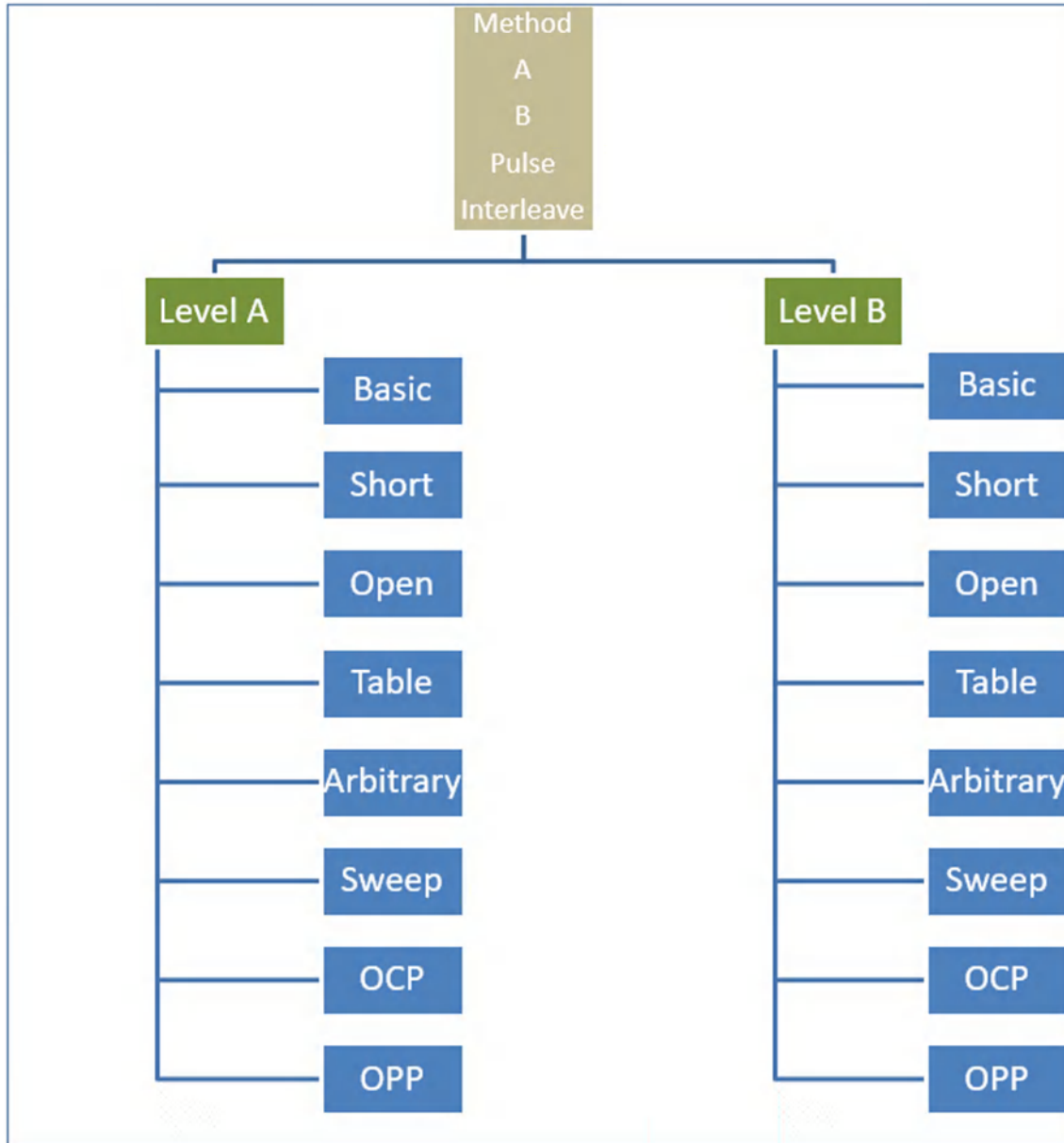

**Figure 3-1 Loading Hierarchy**

---

### 3.1 Terms

---

Method – the top selection of the level or levels to apply.

Level – one of two loading configuration data sets. (A or B)

Mode – a loading mode, such as Basic, Sweep, OCP, etc.

Basic – CC+CR+CV+CW loading function in any combination.

Short – applies the minimum resistance achievable by the unit.

Open – applies the minimum loading achievable by the unit.

Table – configures current based on measured voltage.

Arbitrary – executes a series of basic/short/open steps at timed intervals.

Sweep – executes a timed up and/or down ramp of current or power using a linear or logarithmic curve.

OCP – executes a sweep of current, but will terminate if voltage drops below a configured level.

OPP – executes a sweep of power, but will terminate if voltage drops below a configured level.

Except for OCP and OPP, the A and B levels can be pulsed. The resulting combinations allow a wide array of test protocols.

Battery testing can be enabled that encompasses the level/mode configuration, but is not allowed if the level is set to OCP or OPP. When loading is activated, the amp-hours (Ah) and watt-hours (Wh) are accumulated.

---

### 3.2 Ensuring Accuracy

---

In most applications, DC loads have few stability issues; however, in some configurations and with some power sources and wiring, there may be problems that must be resolved.

#### 3.2.1 Wiring Impedance and Inductance

In most cases, wiring resistance is not a stability issue, and DC losses in the wiring can be accommodated by using the external V sense capability (if provided) of the DC Load, as long as they are not too large.

Wiring inductance can cause issues with the applied current appearing to ring (or be unstable), even though it might not be in the DC Load itself. Most DC Loads have an internal capacitance between the terminals, and in most cases, this is fairly high (e.g., a few 100s of nF or more). This can cause problems with the inductance of the wiring creating a tuned circuit, causing high-frequency current to flow between the wiring and this capacitance (but not through either DC Load or the Source). This places an upper limit on the wiring inductance, even in applications where the load current is not being changed. A length of wire (not twisted) in free air has an inductance of about 6nH per cm, so this should be a concern if the wiring is more than a total of 1.5m in total length (i.e., in both terminals). This is readily diminished by twisting the two wires together to create a 10:1 reduction in most circumstances, but this may be difficult to accomplish if using very heavy-gauge wiring. If the user wishes to use fast-pulsing capability in the DC Load, this becomes even more of a concern, as the voltage across the terminals of the DC Load will be severely diminished during fast transitions of current. As an example, if it is desired to produce a current with edge speeds of 10A/ $\mu$ s and wiring is used with 1 $\mu$ H of total inductance, then

during the current change, the wiring will have a voltage across it of  $L \cdot (di/dt) = 10V$  – making it impossible to generate such changes with a voltage source of less than 10V. For most applications, using a twisted pair of wires is sufficient to reduce this effect to reasonable levels, but in extreme cases (and particularly at high currents), the user may need to construct special wiring using two sheets or thin bars of copper separated by a very thin insulator. Achieving a low inductance is very dependent on the centers of current flow being close together.

In summary, the external wiring between a power source and a DC Load must generally be  $<1\mu H$  in inductance – and considerably less than this (below 100nH) if fast current pulses are to be used. If the wiring length is a total of more than 1.5m (i.e., 0.75m for each wire), then the wiring should be tightly twisted.

### 3.3 DC Loading Regions

Any DC Load operates in one of five regulation regions, each of which has its own stability requirements and problems. These regions are not specific to any DC Load, being generally applicable to all DC Loads; however, these are called “modes” in many products because they use different analog circuitry, and often only one at a time may be enabled.

Each region, if it exists at all, only exists once in the operating voltage range and all are always ordered in increasing applied voltage, as listed below:

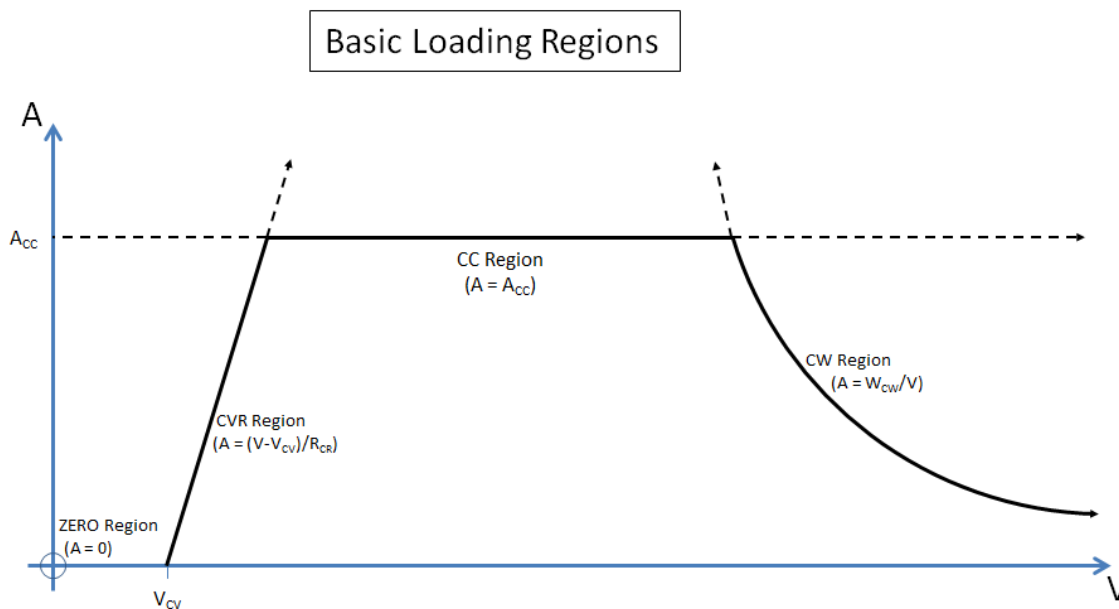

Generally, DC Loads also have specific settings to produce an OPEN or SHORT loading. These are special cases of these regions. OPEN is the special case where all regions except ZERO and CV are disabled, and the CV setting is effectively set above the maximum possible voltage, so the ZERO region extends throughout the entire operating voltage range. SHORT is the special case where all regions except CR are disabled and the CR setting is whatever the hardware limitation is for that specific DC Load.



### 3.3.1.1 ZERO

There is no user setting for this region.

In the ZERO region, the loading current = 0 (zero).

This region always exists at applied voltages below the CV voltage setting, or below zero if the CV region is disabled.

### 3.3.1.2 CV and CR (collectively called CVR)

There is a voltage setting for the CV region and a resistance (or conductance) setting for the CR region; either or both regions may be chosen to be disabled.

In the CVR region, the loading current =  $(V - V_{CV})/R_{CR}$ .

The CV region voltage setting (or zero if disabled) sets the maximum voltage for the ZERO region, and also the minimum voltage for the possible application of all other regions (selected by the region that is both enabled and produces the lowest loading current at that applied voltage).

The CV setting may be disabled, in which case this is simply the CR region. Even if the CR setting is disabled, there always is a CR region enforced by hardware limitations. So, the CR region always exists, and the CV region is really a combined CV and CR region, due to both hardware and stability limitations. Note that if both CV and CR regions are enabled, the CR setting sets the incremental resistance, not the DC resistance.

Though not implemented in any DC Load, it is possible to configure  $V_{CV}$  as negative. In that case, the ZERO region still extends up to zero, because a DC Load only has one loading quadrant (positive applied voltage and sinking loading current), but at zero and above, the loading current is calculated as described here.

### 3.3.1.3 CC

There is a current setting for this region, and this region may be chosen to be disabled.

In the CC region, the loading current =  $A_{CC}$ .

This region might not exist, as it may be totally masked by the CVR region (at lower voltages) and the CW region (at higher voltages); or this region may be disabled, leaving the load current to be regulated by the remaining regions (however, if disabled there still may be a CC region that is set by hardware limitations).

### 3.3.1.4 CW

There is a power setting for this region, and this region may be chosen to be disabled.

In the CW region, the loading current =  $W_{CW} / V$ .

Even if not enabled or configured in a manner which would stop it from existing, this region always potentially exists and is set by hardware limitations. In some DC Loads, this region does not exist if disabled – in which case, should excessive power be generated by the combination of configuration

settings and applied voltage, it causes permanent failure of the DC Load, relying totally on the OTP protection (if any) of the DC Load (which is far too slow to protect MOSFETs from severe dissipation or SOA damage).

---

### 3.4 DC Load Regulation Stability

---

In some cases, this section may also apply to the stability of the power source.

#### 3.4.1.1 CV and CR Region Stability

In these regulation regions, the DC Load adjusts the loading current to try to maintain a constant voltage, or a constant resistance, or a combination of both.

It should be noted that, even when simply named CV operation, there is always a non-zero  $R_{CR}$  even if not configured, so all DC Loads really regulate with a CVR region (the pure CR region is just CV/CR with a zero  $V_{CV}$  setting).

In some cases, this can be the most complicated region to stabilize. Although the DC impedance of the external source and wiring causes negative feedback, all DC Loads have complex internal feedback to regulate in this manner, so they have a phase shift of well over  $90^\circ$  at higher frequencies, and the source may also have at least a  $90^\circ$  phase shift (e.g., a perfect current source with a parallel capacitance gives  $90^\circ$  phase shift at all frequencies). This means that some ringing always exists when the current or voltage is changed, and if the source/wiring impedance becomes too high at frequencies where the phase shift is  $180^\circ$  or more, the system will oscillate. The frequency above which the DC Load has  $90^\circ$  or more phase shift in CVR regulation varies considerably between models. For high-speed models, this may be 20kHz or more; for many models, it is only a few Hz.

It must be noted that the problem in this regulation mode with external source impedance is only an issue at higher frequencies (where the total phase shift is high) and is not a problem at DC (where there is no phase shift). At DC, there is no limitation on the external impedance regarding stability, so – as often found – when the source is actually a voltage source and a series resistance, the system is usually stable, as the resistance typically has very little phase shift.

The result of this higher-frequency limitation is that the source+wiring impedance ( $Z_E$ ) must be less than  $R_{CR}$  (whether configured or parasitic) at all frequencies where the phase shift is appreciably over  $90^\circ$ . This includes inductance, capacitance, and resistance – although inductance is of less concern since it has an opposing phase shift.

When specifically configuring a DC Load for CR operation (i.e., with CV disabled), the configured  $R_{CR}$  is quite high, so this problem is usually of little concern (e.g., if the DC Load is set to generate a load of  $10\Omega$ , then the source+wiring impedance must be significantly less than this at higher frequencies).

When specifically configuring a DC Load for CV or CVR operation, the  $R_{CR}$  (configured or parasitic) will usually be very low (perhaps only  $1m\Omega$  or less), making it very difficult to have less than this in source+wiring impedance at higher frequencies. Because of this, many DC Loads apply frequency response reduction when regulating CVR loading, giving a higher  $R_{CR}$  at higher frequencies, making it

easier for the source+wiring impedance requirement to be met. In addition to this, the presence of the capacitance between the terminals of the DC Load assists in this, because that capacitance effectively reduces the external impedance (e.g., 300nF at 20kHz is 26.5Ω).

In summary, if the DC Load is configured for a  $R_{CR}$  of a few ohms or more, this is generally of little concern; however, if set for a very low  $R_{CR}$  value, or only has the parasitic resistance of a pure CV regulation region, high frequency instability caused by too high of an impedance and/or phase shift in the source and wiring is of extreme concern. Some DC Loads have settings available that allow the user to alter the high-frequency dynamics of the loading; however, even when present, there can be little to assist the user in deciding on those settings without resorting to trial and error.

#### **3.4.1.2 CW Region Stability**

The CW regulation region is similar to the CV/CR regions, in that the loading current is determined by the applied voltage; however, the issues involved are very different.

The regulation of the loading current in the CW region means a DC lockup or stability issue exists, since source + wiring impedance causes positive feedback at all frequencies (including at DC). This places an upper limit on the DC source and wiring impedance of  $0.25 \cdot V^2 / W_{CW}$ . For example, if configured to maintain a constant 500W and the applied voltage is 100V, then the source and wiring impedance must be significantly below  $0.25 \cdot 100 \cdot 100 / 500 = 5\Omega$ ; if above 5Ω, then the DC Load will “lock” to being a short, and if slightly below 5Ω, it may be unstable. This is generally of little concern. High-frequency phase shift is also of little concern, as the phase shift of the system is already 180°, so phase shift in the source and wiring impedance actually makes the system more stable.

In summary, the source and wiring impedance must be significantly less than  $0.25 \cdot V^2 / W_{CW}$ ; this is usually calculable and achieved with ease.

#### **3.4.1.3 Stability and the Vitrek DL Series of DC Loads**

As discussed above, the region of primary concern with any DC Load is the stability of the CV/CR regions, collectively called the CVR region in the DL Series.

The DL Series has a parasitic  $R_{CR}$  of  $<0.1\text{m}\Omega$  when operating a simple CV region. This effectively makes it impossible for the user to achieve stability by ensuring a low source and wiring impedance. The DL Series have a 90° phase shift at a frequency of nominally 30kHz when regulating in the CVR region, which implies that the source and wiring impedance must be significantly less than 0.1mΩ at that frequency and above (which is virtually impossible to achieve). But the user often requires the  $R_{CR}$  setting to be very low for proper low frequency and DC operation of testing.

The DL Series has settings that allow the user to restrict the bandwidth of the loading current in several ways: limiting the time constant of changes, limiting the maximum rate of change, and (presently) limiting the bandwidth of all uses of the voltage. Any instability issues can generally be mitigated by using these settings; however:

- The limitations imposed by these settings to ensure stability in the CVR region may need to be severe, and those settings all apply to all loading regulation regions, which may not be desirable to the user, so:
  - There is additionally a setting for incorporating an Rhf to assist in setting the stability in the CVR region. This should be set to the expected resistance of the load+wiring at approximately 30kHz.
- It is almost impossible for the user to determine, without trial and error, which setting should be used to mitigate stability issues, so:
  - The user may modify the value manually as needed to achieve stability if needed. A low Rhf yields faster response times, while a higher value yields slower responses, so it is best to have a low Rhf value if possible.

## 4 Menu Structure

### 4.1 Introduction

The DL Series is a programmable test instrument for testing of DC power supplies, batteries, DC to DC converters and battery chargers. The unit uses a simple menu structure to allow programming and setting options for testing loads. The settings can be saved and reloaded. This chapter describes common functions for the various touch screens. All of the illustrations are shown using the default color theme except for the section that discusses the available themes.

### 4.2 Quickstart

These are the most commonly used screens for viewing results or configuring the loading operation.

**Numeric Results** - Shows numeric results updated 10 times/second



Figure 4-1 Numeric Results

**XY Chart** - A scatter plot of one measurement against another.

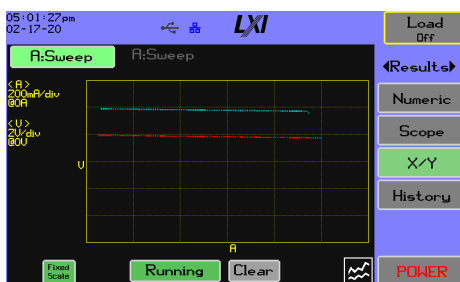

Figure 4-3 XY Chart

**Loading Configuration** - The top level loading configuration screen showing a summary of the DC load settings.

**Scope** - Oscilloscope functions with optional triggers synchronized to loading functionality

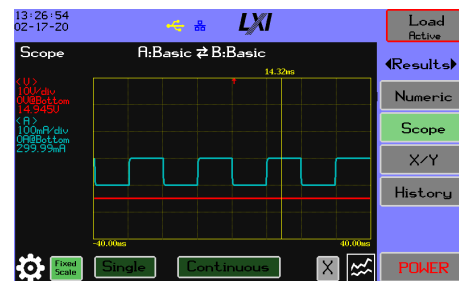

Figure 4-2 Scope

**History Chart** - Charting of up to four measured results vs elapsed time. Data is always recorded without you having to make configuration settings.

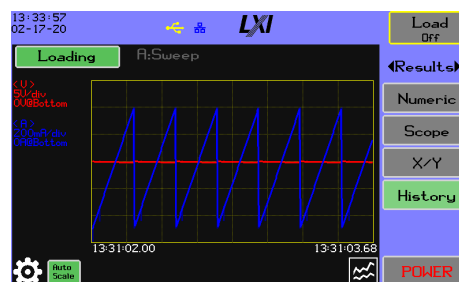

Figure 4-4 History Chart

**System->About** - Model information, internal file system status, and the unit's IP address.

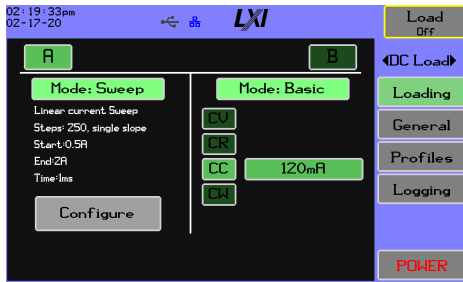

Figure 4-5 Loading Configuration



Figure 4-6 System->About

### 4.3 Menu Summary

After starting the DL, the Results screen is displayed as shown in the example screen in Figure 4-7 Typical Start Screen. The presently selected menu is displayed on the right side of the screen.



Figure 4-7 Typical Start Screen

The menu system organizes the control and display functions into three groups:

Table 4-1 Menu Summary

Title	Description
Results	Shows various methods for viewing the measurement results.
DC Load	Load operation settings.
System	Unit information, system-level settings and user preferences, export/import configuration to external media.

The arrow keys on either side of a menu title scroll the menu choices; as each group is selected, the last used menu option will be activated.

The system will always attempt to start up with a display of the most recently viewed result screen. The following circumstances may prevent the most recent view:

- 1) A critical fault occurred and must be handled after a power cycle.
- 2) The most recent view is no longer available. This typically happens if the configuration option that allowed the view was changed (e.g., the user viewed battery results, navigated to the general settings, turned the battery testing mode off, then shut down the unit).

#### 4.4 Common Display Elements

The graphics display area is comprised of four distinct components. Figure 4-8 DL Series Display Overview identifies these areas:

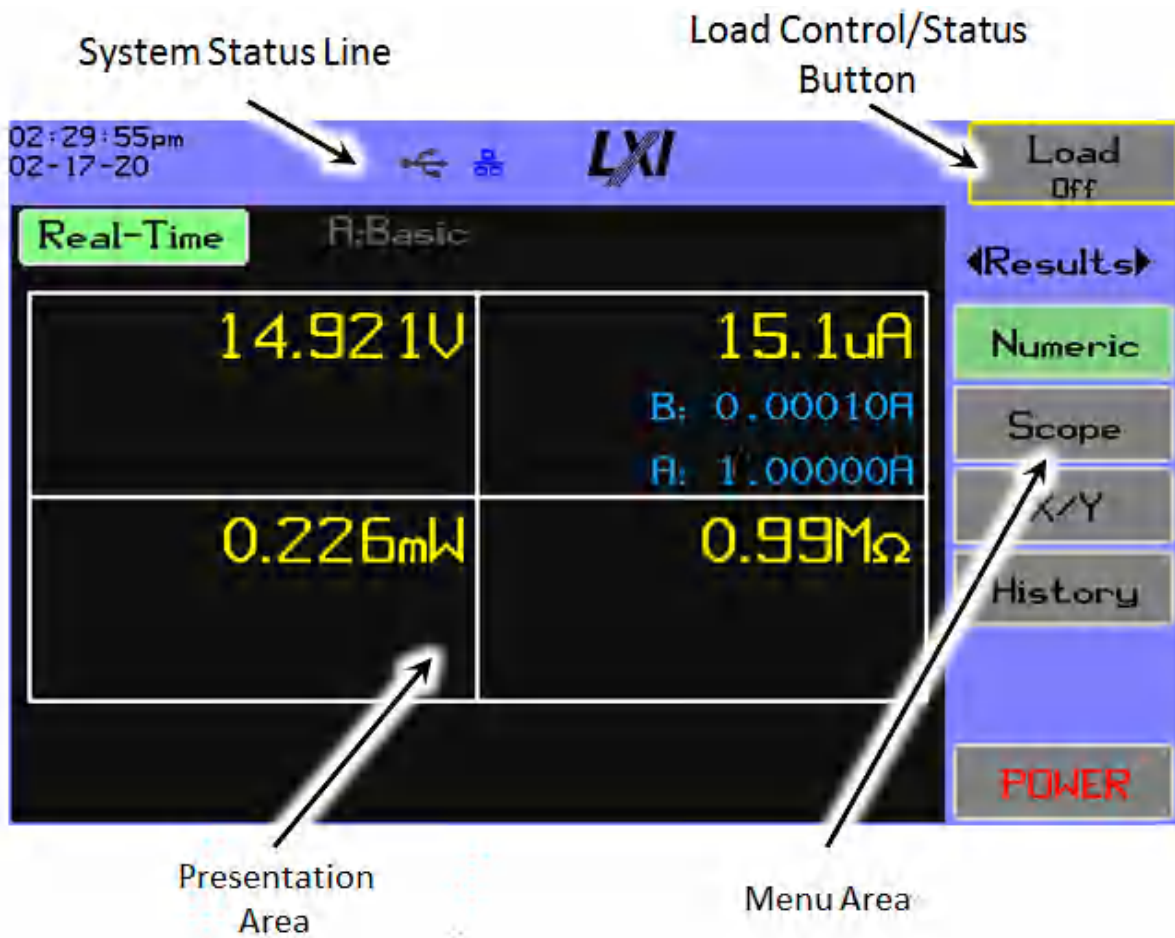

**Figure 4-8 DL Series Display Overview**

- a) Status line
- b) Load Control/Status button
- c) Menu area
- d) Presentation area

---

## 4.5 Common Behavior

---

### 4.5.1 Touch Panel Operation

When the panel is touched the Power-LED will brighten. If the unit is configured to auto-dim and the display has dimmed any touch to the panel only acts to restore normal brightness and will cause no further action. If the display is automatically dimmed and a flash drive is inserted the display will activate as it was touched.

The DL LCD panel touchscreen is used for most manual user interaction with the instrument.

- Do not use a pen or pencil, or a sharp object, or a fingernail on the touchscreen, this may damage the screen.
- Do not apply excessive pressure to the touchscreen otherwise it may be damaged.
- The touchscreen interface has been designed to not require the use of a stylus; however, one can be used if desired. If a stylus is used then ensure that it has a smooth surface where it touches the screen and do not apply excessive force, otherwise it may damage the screen.
- It is not recommended to use bulky gloves with the instrument, you may have to resort to a stylus to navigate accurately.
- Typically, the display shows the areas which may be used as buttons or controls with the touchscreen. Most exceptions to this involve the series charts and history where a data cursor is involved.

### 4.5.2 OK/Cancel

When modifying various settings, the option of OK or Cancel is displayed on the screen. Pressing the **OK** button will save the settings and return to the previous screen. Pressing **Cancel** will not save the settings and return to the previous screen. The settings are saved in non-volatile storage when the user utilizes the **OK** button, not stored when **Cancel** is pressed. Besides the obvious behavior associated with **OK** or **Cancel**, there is an implied **OK** if the user presses a menu button in a setting screen and navigates to another screen. The implied **OK** also applies to the **POWER** button.

### 4.5.3 SI Conformance

The unit uses International System of Units (SI) rules when displaying all the settings and most of the measurement results within the Results menu. A specific exception to the display of settings is those shown on the numeric results display available for changes via the rotary dial; they are shown fixed width using whole units.

### 4.5.4 Small Line Plot



This icon is used select a trace color on the screen display.



#### 4.5.5 Trace Settings



This icon is used to change the trace preferences for the current screen.

#### 4.5.6 Settings



This icon is used to bring up a dialog box with options to configure the chart and change the display.





---

### 4.6 Load Status and Control Buttons

---

The button on the upper right of the display always shows the present status of the loading function. The following figures illustrate the button's symbology.

**Table 4-2 Load Status Descriptions**

Display	Description
	The load is off.
	The load is armed for one of the trigger conditions to activate the load.
	Loading is active.
	This indicates an attempt was made using the front panel to activate the load and the action was blocked by a fault or the trigger configuration disallows front panel operation. See section 5.3.2.11 for details on configuration.
	The load has tripped (loading forced off) due to a critical condition: over-voltage or over-temperature. The user can attempt to clear the condition by pressing the button.

<div style="background-color: orange; color: black; padding: 5px; border: 2px solid red; display: inline-block;"> <b>Load Fault</b> </div>	<p>A fault in the loading sub-system has been detected and the load has tripped (loading forced off). Only a successful self-test can clear the condition. See section 10 for more details.</p>
--	---

## 4.7 Status Bar

### 4.7.1 Item Behavior

The status bar is always present at the top of the display. Some of the symbology is always shown and will change color to indicate status; other symbols will only appear under certain circumstances. Figure 4-9 DL Series Status Bar illustrates the status bar items. The behavior of each item is listed in Table 4-3 Status Bar Item Behavior.

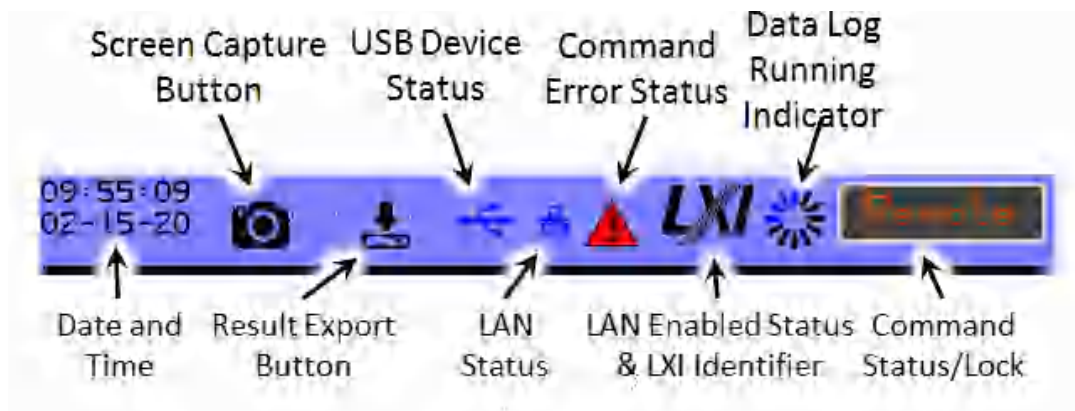









Figure 4-9 DL Series Status Bar

Table 4-3 Status Bar Item Behavior

Information	Behavior
Date/Time	Always present and updated every second. If the time is shown in Yellow, the clock has not been set since the battery was installed; if the time is shown in Red, the battery clock should be replaced.
Screen capture button <sup>1</sup>	Only present if a valid USB drive has been inserted. Pressing this button causes the present screen image to be captured to a file on the USB drive. The file takes the form <i>screenNN.png</i> , where <i>NN</i> is the digits 00 to 99. The unit will try the lowest-numbered

<sup>1</sup> If the USB drive has an error or is using an unsupported format, the area taken by the screen capture button will instead show a USB drive image with an error code: **X** for a hardware error, or **?** for unsupported media.



Information	Behavior
	digits first, so as to not overwrite a previously saved image; if all combinations are exhausted, it will overwrite <i>screen99.png</i> .
Result export button	Only present if a valid USB drive has been inserted. If pressed while viewing any of the results screens, a file is written in <i>csv</i> format containing results represented by the presently viewed context. See sections 5.3.3 Export/import settings for details on the file names and contents.
USB connection status	<p>Always present and shows the USB device status:</p> <p> – Disabled</p> <p> – Disconnected</p> <p> – Enumerated: attached to a host computer and properly configured (driver installed).</p> <p> – Connected: a host computer application has connected to the virtual COM port (VCP).</p>
LAN status	<p>Always present and shows the LAN interface status:</p> <p> – No Link</p> <p> – No Address: Link integrity achieved but no address has been assigned.</p> <p> – Addressed</p> <p> – Addressing error indicator, either a static address conflict or a DHCP failure (timeout or invalid address).</p>
Command error status	Only present if a command interface is active and will be shown if an error or event is queued for retrieval by the command interface. See section 5.3.1 - About for details on viewing the queue locally.

Information	Behavior
	Always present and will flash if the LXI <b>Device Identify</b> function is activated. If the interface is disabled, the logo will be grayed out.
Data log running indicator	Shows when the data log is actively running.
Command status/lock	Only present if a command interface is active and is one of the following indicators: <ul style="list-style-type: none"> <li>• Remote – The connection is active and local control is disabled.</li> <li>• Locked – The connection is active, and local control is disabled and locked.</li> <li>• Local – The connection is active, but local control has been enabled.</li> </ul>

#### 4.7.2 System Alerts and Faults

There are several alerts that notify the user that instrument operation is or may become compromised:

- Excessive voltage on the inputs - tripped.
- High temperature - system tripped.
- DC load fault – system tripped.
- High voltage warning.
- High temperature warning.
- A fan failure has occurred – loading current and power will be limited.

The alert notification takes priority over several of the status line indicators:

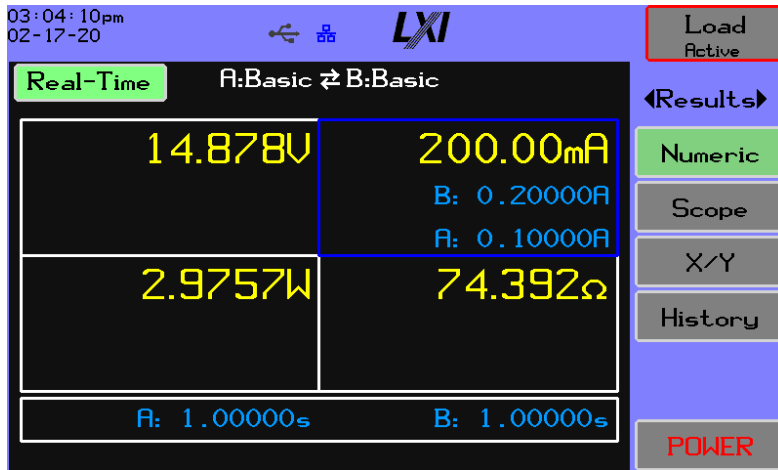

**Figure 4-10 Example Alert Notification**

If the alert caused the DC load to trip the entire screen will show the status condition. See section 10 Troubleshooting to diagnose the fault conditions.

## 4.8 Dial Settings

Adjustment of the current levels for a basic-to-basic pulse configuration will be used to illustrate the function of the rotary dial to configure loading parameters, as shown in Figure 4-11 Load Active Screen. Only the Real-Time, OCP, and OPP numeric results screens allow dial adjustments.



**Figure 4-11 Load Active Screen**

The user can tap one of the settings in Blue to activate the dialing process; the item becomes ready for possible changes and is shown in **White**. Rotation of the dial at this time moves forward or backward over the list of possible settings. Touch the same setting to turn the dial off and touch another setting to move the selection. Push the dial button to select the value and place the cursor on the least-significant digit. For this example, level A current will be used as shown in Figure 4-12 Adjust Level A Current:

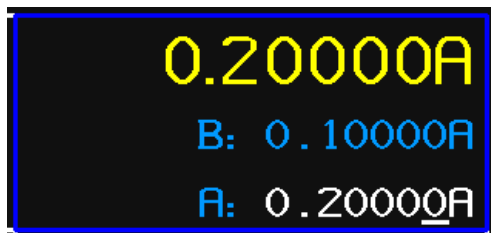

**Figure 4-12 Adjust Level A Current**

Rotate the dial to scroll the cursor as shown in Figure 4-13 Dial Rotation Scroll Cursor:



**Figure 4-13 Dial Rotation Scroll Cursor**

Press the dial button to select the digit for editing, press again to revert to digit scrolling, and change a digit to cause the setting to be marked with an asterisk; this notes that it is different from the basic configuration, as shown in Figure 4-14 Select Digit to Alter:

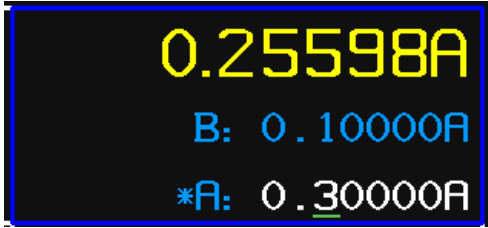

**Figure 4-14 Select Digit to Alter**

Increasing a digit from 9 causes rollover, so incrementing the 9 in 0.20900 results in 0.21000. Decrementing the same digit when it is 0 results in 0.19900.

## 5 Front Panel Operations

### 5.1 Results

#### 5.1.1 Introduction

There are four top-level result displays summarized in Table 5-1 Result Displays:

**Table 5-1 Result Displays**

Display	Description
Numeric	Display of measurements in numeric form. Multiple views are available, depending on the loading configuration.
Scope	A high-resolution digital scope to capture events without interfering with other measurements. The trigger event can synchronize with the loading function or measured levels. A cursor is available for zooming and obtaining numerical levels.
X/Y	An X/Y chart allows a choice of data sources and selection of any of the measurements for an axis.
History	The unit automatically maintains a continuous historical recording of measurement data – no configuration is needed. Any data from this record may be viewed with user-defined scaling, offset and color, with a user cursor available for zooming and obtaining numerical levels.





With the exception of Scope, all displays show a data source choice at the upper left corner of the screen. A loading configuration summary line is at the top center, and the position of the manual trigger button is at the top right of the screen. The intent of the configuration summary is to show: (A) what the load operation would be if activated, or (B) the present operational state (and if the active configuration allows, buttons to switch the levels). When loading is off, the loading summary line will show either one or two level indicators; when two levels are enabled for pulsing, a double arrow will display between the mode labels. Table 5-2 Loading Level Examples illustrates several examples:

**Table 5-2 Loading Level Examples**

Display	Description
A:Basic	The basic configuration for level A will be loaded.
B:Table	The table configuration for level B will be loaded.
A:OCP	The OCP sweep for level A will be loaded.
B:Sweep	The B level sweep will be loaded.
A:Basic↔B:Basic	The A and B basic levels will be pulsed, based on the configured intervals.
A:Arbitrary↔B:Arbitrary	The A and B arbitrary levels will be pulsed, based on the configured intervals.
A:Basic↔B:Arbitrary	The A level basic will be pulsed or interleaved with the B level arbitrary configuration.

When the load is activated, the summary line will be highlighted; in some cases, buttons will become available to manually switch between the levels, as shown in Table 5-3 Load Level Manual Switch. The manual switch is only available for a few combinations:

**Table 5-3 Load Level Manual Switch**

Display	Description
	The user can switch between the A and B basic levels.
	The user can switch between the A basic level and B open level, or vice versa for Open/Basic.
	The user can switch between the A basic level and B short level, or vice versa for Short/Basic.
	The user can switch between the A Arbitrary level and B Basic level, or vice versa for Basic/Arbitrary.

### 5.1.2 Numeric Results

The numeric result displays, as seen in Figure 5-1 Real-Time Numeric Results Screen, all have a common format that shows measured Voltage and Current, derived Power, and the loading conductance/resistance value. Where allowed, there may be up to ten load settings that can be adjusted with the dial while loading is active. Note that the results for power and conductance/resistance may not be shown if loading is off.

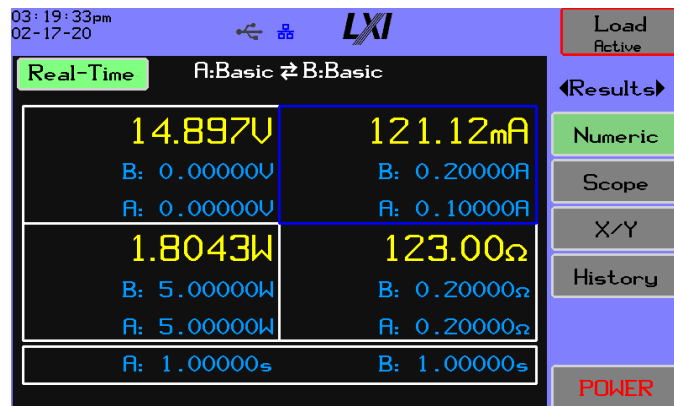

**Figure 5-1 Real-Time Numeric Results Screen**



The button in the upper left corner can select various available numeric results, depending on the loading configuration. Information on setting the Loading Configuration can be found in the Settings section under 5.2.1 – Loading and 5.2.2 – General. The views available are listed in Table 5-4 below, note that not all views are available depending in loading configuration settings.

**Table 5-4 Numeric Result Views**





Option	Description
Battery	Available when battery testing is enabled, it displays accumulated amp-hours, watt-hours, and time.
A:OCP B:OCP	Replaces the live current measurement with the current measured when the sweep completed (a Fail condition), or when the DUT cut off the voltage (pass).
A:OPP B:OPP	Replaces the live power measurement with the power measured when the sweep completed (a Fail condition), or when the DUT cut off the voltage (pass).
A:Synchronous	Displays the four measurements taken at a time synchronized with the A level's pulse. If the pulse rate is very high, these values may not be available.
B:Synchronous	Displays the four measurements taken at a time synchronized with the B level's pulse. If the pulse rate is very high, these values may not be available.
Efficiency	Displays the power supply input power as measured by the internal Wattmeter or an external PA9xx power analyzer and the computed efficiency of input power versus output power.

### 5.1.2.1 Result symbology

When loading is active one of the measured items will be highlighted by a dark blue rectangle to indicate the active loading region. Typically, only one limit is in place, current for CC, power for CW, voltage for CV, etc. If more than one loading limit is configured the highlighting may move over time.

For each measured value there is an indicator showing when the loading has been restricted. The following table lists the indicators for each measurement.

**Table 5-5 Numeric Result Indicators**

Measurement	Indicator(s)
Voltage	 Displayed if soft-start limiting was applied.
Current	 Shows when the current was lower than the configured setting.  Shows when the loading current was not properly regulated.
Power	 Shows when the power was lower than the configured setting.
Resistance/Conductance	 Shows that the configured or computed resistance was limited to a value lower than configured; note the arrow will be inverted if the display preference is set to conductance.

### 5.1.3 Scope

The DL incorporates an independent oscilloscope function available through the scope results display, as shown in Figure 5-2 Scope Results Screen. A variety of trigger modes are available related to either the loading or measurement functions. The small red arrow at the top of the graph shows the trigger position.

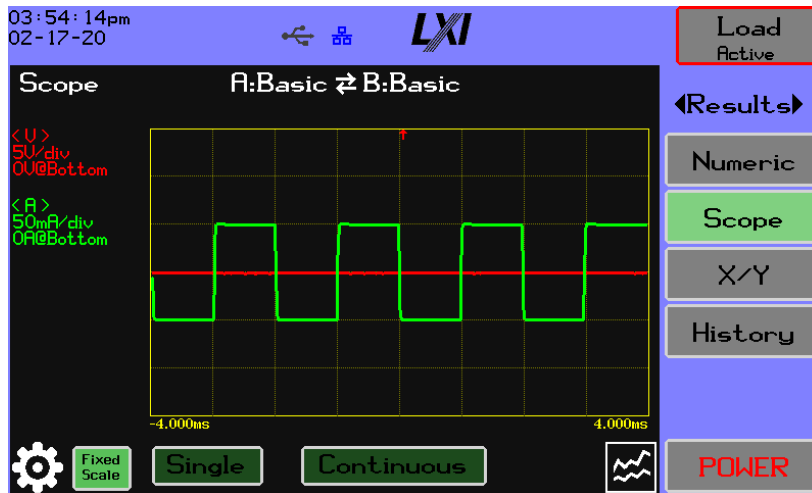

Figure 5-2 Scope Results Screen



When capture is running, the operation buttons will change to show the status of the capture.

#### 5.1.3.1 Scope Summary

The Results Scope Screen has the following functions:

- Single – Pressing the button initiates a single capture and will show the results when they become available.
- Continuous – Pressing the button initiates continuous capture and the display will update every time fresh updates become available.
- Scroll over data – Touching the chart area or using the dial will activate a cursor line. Turning the dial or touching the screen will move the cursor line over the graph.
- Zoom Mode – Pressing the dial toggles between scroll and zoom. When in scroll mode, the cursor moves across the chart area. When in Zoom mode, the times zoom is displayed above the cursor line as xN, where N is the value of the zoom.
- X – Pressing the button removes the cursor.
- Fixed Scale/Auto Scale – Press the Fixed Scale button to toggle between Fixed Scale and Auto Scale mode. See section 5.1.3.5 for details on using the scaling control.
- Gear icon – Press the button to bring up the capture configuration screen (see Figure 5-3 Scope Capture Settings).
- Trace icon – Press the button to bring up the trace configuration screen (see section 5.1.3.3).

### 5.1.3.2 Scope Capture Settings



Figure 5-3 Scope Capture Settings

The user can configure one of 10 trigger conditions, as shown in Table 5-6 Scope Results Trigger Conditions:

Table 5-6 Scope Results Trigger Conditions

Trigger	Description
V-rising	The V samples changing from below to above the trigger level (i.e., a rising edge trigger).
V-falling	The V samples changing from above to below the trigger level (i.e., a falling edge trigger).
A-rising	The A samples changing from below to above the trigger level (i.e., a rising edge trigger).
A-falling	The A samples changing from above to below the trigger level (i.e., a falling edge trigger).
To A	A change to level A from level B.
To B	A change to level B from level A.
To On	A change to the loading ON state from the OFF state.
To Off	A change to the loading OFF state from the ON state.
Step A	Starting a specific step in level A.
Step B	Starting a specific step in level B.
Manual	A capture is always made as soon as possible, asynchronous to any signal or loading.

The timebase can be selected using 1/2/5 standard intervals from 10 $\mu$ s to 2s. The trigger position is configured as a function of the captured data interval in terms of a percentage.

### 5.1.3.3 Scope Trace Preferences

The trace settings icon in the lower right of Figure 5-2 Scope Results Screen brings up a dialog for configuring the traces to display and the fixed scaling values as shown in Figure 5-4 Scope Trace Preferences:



Figure 5-4 Scope Trace Preferences

The checkboxes allow the user to determine which traces to display and the small line plot icons can be touched to select a trace color. The first labeled button allows the user to select the zero position of the trace: one of **Top**, **Center**, or **Bottom**. The **Offset** setting is subtracted from the measurement to shift it down (positive offset) or up (negative offset). The **Per/Div** setting configures the units per vertical division.

### 5.1.3.4 Scope Cursor Operation

Along the left side of the scope display is a legend showing the present scaling of the selected traces; when the cursor is active, the legend also shows the cursor readouts as shown in Figure 5-5 Present Scaling and Cursor Readouts Example.

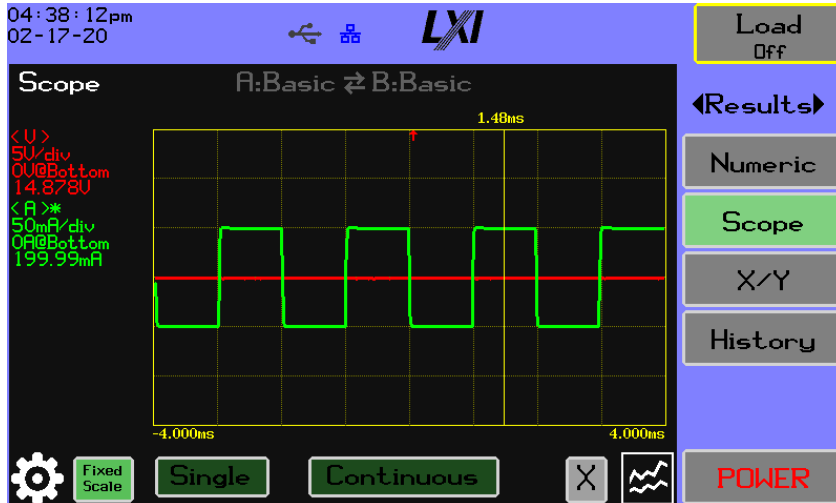

Figure 5-5 Present Scaling and Cursor Readouts Example

The character surrounded by <> identifies the measurement and matches the trace color setting; the next line below is the per-division scale factor, next down is the trace position, and finally the cursor readout is shown. Pressing the dial toggles between zoom and scroll; when scrolling, the cursor shows the relative time of the sample; when zooming, the cursor shows the per-division time interval as shown in Figure 5-6 Per-Division Time Interval:

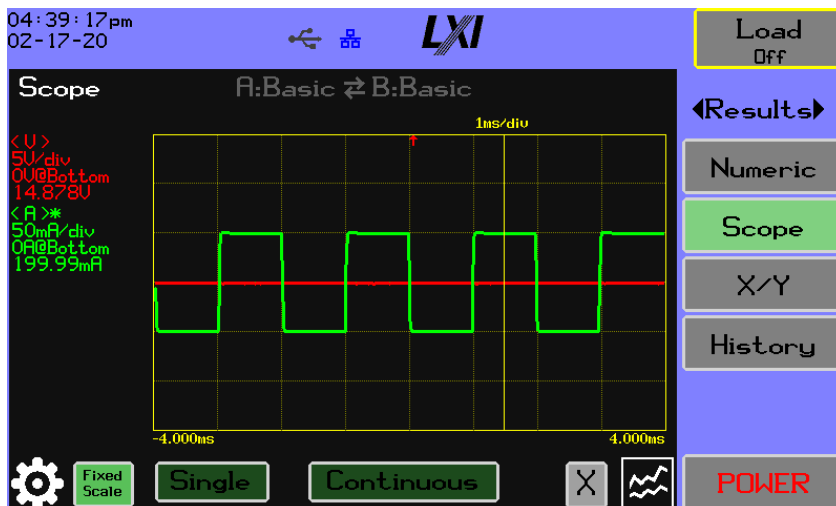

Figure 5-6 Per-Division Time Interval

The amount that can be zoomed will be limited to a function of the timebase. When scrolling, if the time scale has been zoomed, the display will scroll if the user moves the cursor off the left or right.

### 5.1.3.5 Scope Trace Scaling

Touching the scale option button toggles between **Fixed** and **Auto** scale modes, fixed is the default with the instrument is powered on. **Fixed** scaling uses the per-division uses the settings discussed in 5.1.3.3. When auto-scaled, the per-division values are recomputed when a new capture data set is collected to fit on the chart. While in **Fixed** mode, the trace legend can be touched to cause scaling for the associated trace to be automatically computed; in that case, the legend is shown with an asterisk. The following figure illustrates the scope capture of an A/B loading cycle with different scaling options, respectively fixed, automatic, and fixed/automatic. The source was a 3.3V supply pulsed between 500mA and 340mA.

Fixed

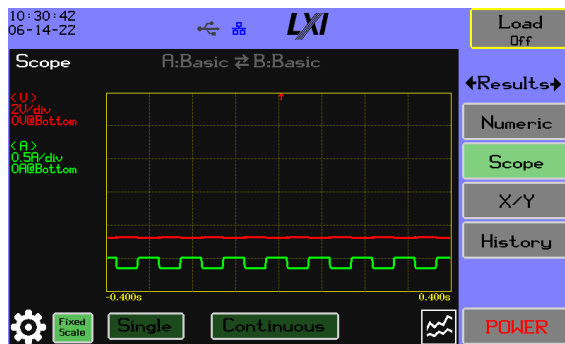

Automatic

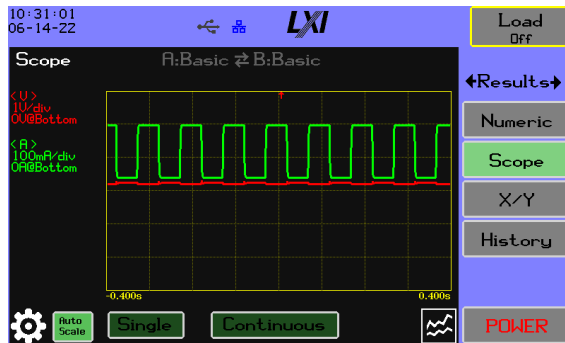

Fixed/Automatic

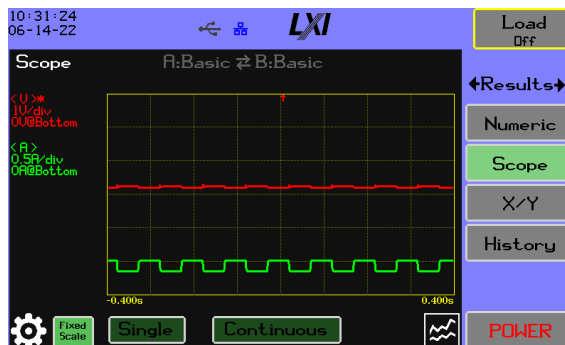

Figure 5-7 Scope Scaling

### 5.1.4 X/Y

The X/Y chart in Figure 5-8 X/Y Results Screen is a scatter plot of one measurement against another. Over time, the selected measurements will be plotted on the chart. By convention, you might want the dependent variable on the Y axis and the independent variable on the X axis. Depending on the data source, the chart may be updated continuously or in bursts. When the load configuration type is a dual sweep, the second half of the sweep is plotted in a different color, as illustrated.

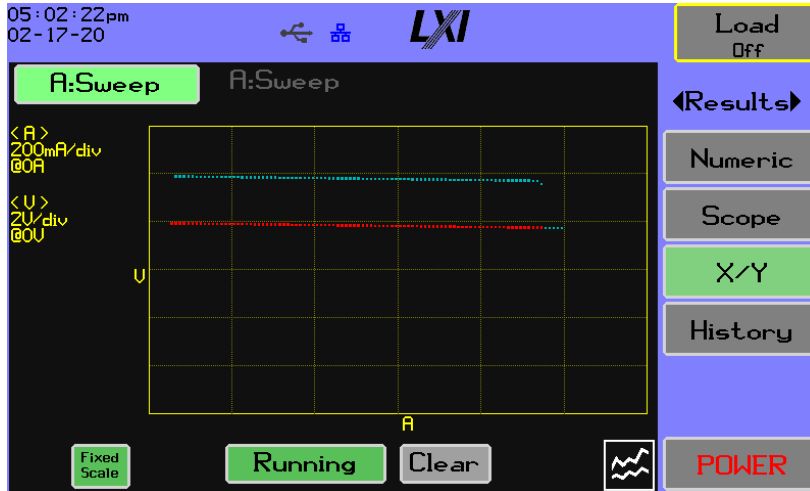

Figure 5-8 X/Y Results Screen

The source of the data can be selected as described in Table 5-7 Results X/Y Data Source:

Table 5-7 Results X/Y Data Source

Source	Description	Updated
Slow Async	The display is updated with measurements reported at 100ms intervals. The measurements are taken asynchronously to the loading function.	Continuous
Fast Async	The display is updated with measurements reported at 1ms intervals and is updated in bursts. The measurements are taken asynchronously to the loading function.	Continuous
A:Sweep B:Sweep	Plots synchronous measurements taken at each sweep step.	Burst
A:Arbitrary B:Arbitrary	Plots synchronous measurements taken at each arbitrary step.	Burst
A:OCP B:OCP	Plots synchronous measurements taken at each OCP sweep step.	Burst
A:OPP B:OPP	Plots synchronous measurements taken at each OPP sweep step.	Burst



The plotted data will be displayed using a **Fixed** scale, continuously **Auto** scaled, or manually scaled if the user touches the legend for the X or Y value.

The line plot  icon is used to configure the measurements, scaling, and color(s) of the plotted data points as shown in Figure 5-9 XY Chart Settings.

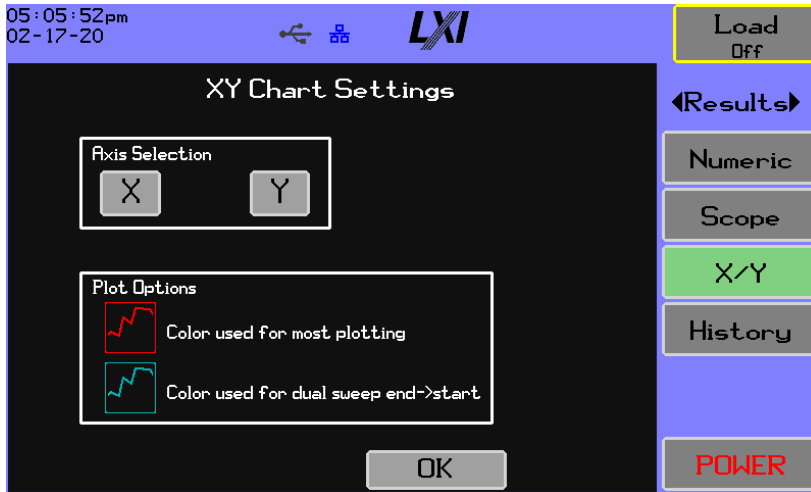

**Figure 5-9 XY Chart Settings**

The X and Y buttons, respectively, bring up dialogs for configuring the X and Y axis, as shown in Figure 5-10 X/Y Plot Y-Axis Preferences and Figure 5-11 X/Y Plot X-Axis Preferences.

**Y-Axis**

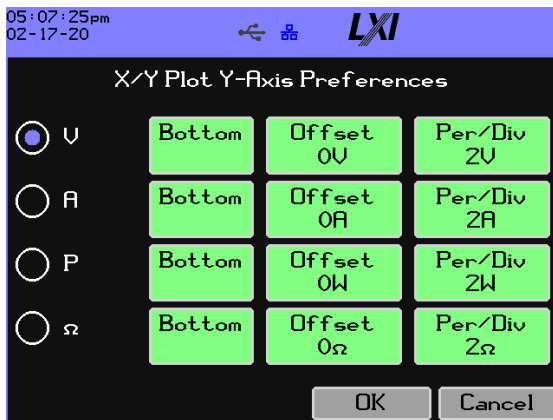

**Figure 5-10 X/Y Plot Y-Axis Preferences**

**X-Axis**

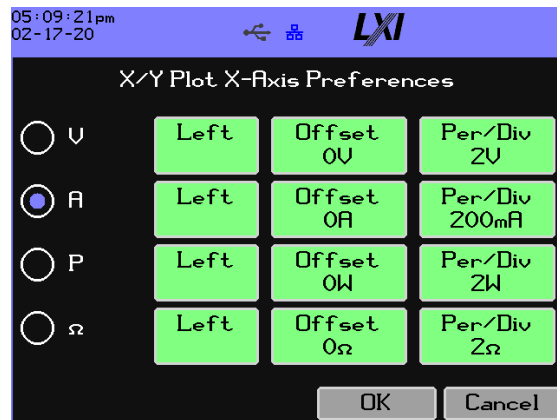

**Figure 5-11 X/Y Plot X-Axis Preferences**

The positioning options differ, depending on the axis direction.

The user selects a measurement for the axis and optionally configures the position, offset, and per/div values similar to Scope.

### 5.1.5 History

The display in Figure 5-12 History Results Screen gives access to a chart of the four instrument measurements versus elapsed time. When the instrument is started the history store commences recording data into the **Standard** record, this record can be stopped and started by the user. A separate **Loading** record is created when the load is activated and covers the time span of the last test cycle.

The recorded data elements consist of average, minimum, and maximum samples from the 1ms measurement intervals. There is no time limit on the record store; over time adjacent samples are coalesced by preserving the extents and averaging the averages.

The chart provides options to configure the display format, what measurements to display, and value scaling. Note that regardless of what measurements are selected to display all items continue to be recorded. The display always plots the averages; the max/min are optional.

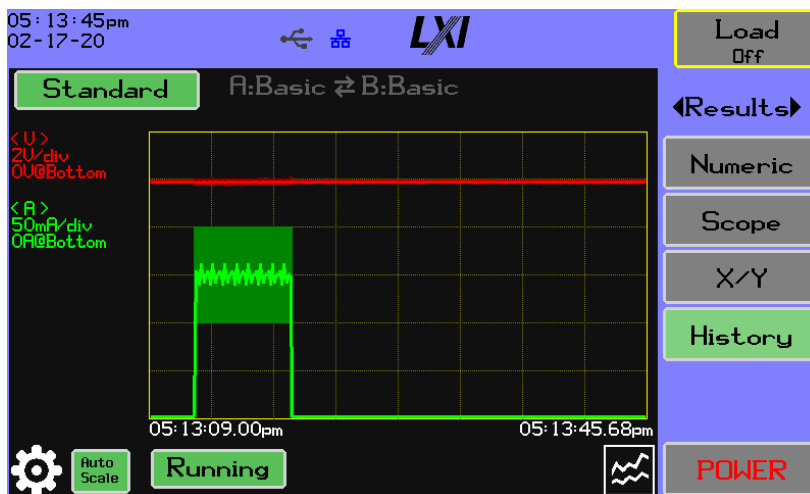

Figure 5-12 History Results Screen

The button on the upper left toggles between history data records: **Standard** contains continuously sampled data that can be stopped and started with the *Running* toggle button; the **Loading** set carries measurements taken the last time loading was activated.

Touch the displayed chart or manipulate the dial to bring up a cursor for scrolling over the data; press the dial repeatedly to toggle between scroll and zoom. When the cursor is enabled, press the **X** button to remove the cursor. Press the dial or the screen to bring the cursor back.

The scale button chooses if all traces will be scaled using **Fixed** using static settings or **Automatic** per trace. When using Fixed mode, the item's legend can be touched to automatically scale the data.

The settings  (gear) icon in the lower left corner brings up a dialog to configure the chart's options, as shown in Figure 5-13 History Chart Options:



Figure 5-13 History Chart Options

The radio buttons allow the user to select how the time is formatted; the **Show Extents** checkbox enables display of maximum/minimum extents in one of two forms:

- Fill – draws vertical lines up and down from the average sample point.
- Trace – draws the maximum and minimum as distinct horizontal lines.

The **Traces** button  in the lower right corner of the History chart opens a dialog for selecting the measurements to display and configuring the scaling, as shown in Figure 5-14 History Trace Preferences:



Figure 5-14 History Trace Preferences

## 5.2 DC Load menu

The DC Load menu is associated with loading and measurement configuration parameters. The four menu items shown in Figure 5-15 Loading Configuration Screen are:

- Loading – method and level configuration.
- General – configuration of settings for all loading levels.
- Profiles – saving or recalling named test configurations.
- Logging – configuration of background data logging.

### 5.2.1 Loading

The Loading screen displays the current load configuration for the DL. Figure 5-15 Loading Configuration Screen, shows levels A and B are configured for Basic loading. Pressing the A or B button enables that level. Once the level's mode is set, other settings can be adjusted by pressing a button the screen.

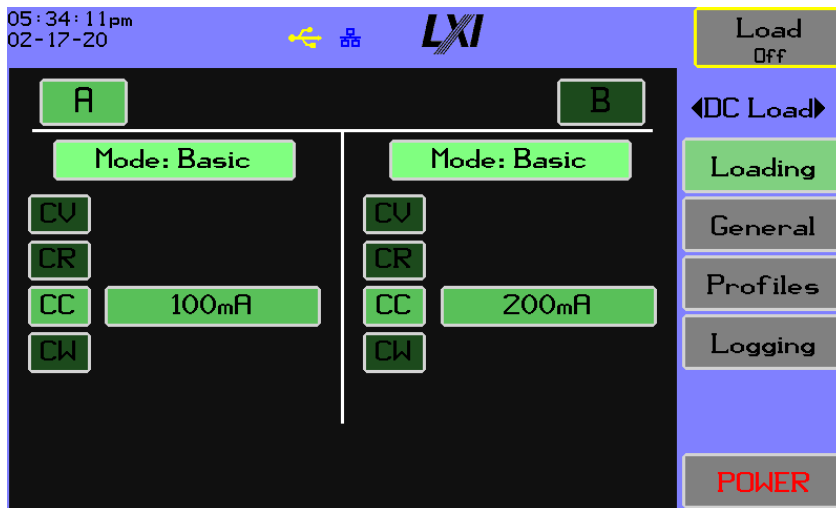

Figure 5-15 Loading Configuration Screen

The intent of the Loading screen is to show enough information to allow the user to determine the loading performance at a glance. The A button toggles the use of the A level, and the B button toggles the use of the B level. Depending on the level modes, sometimes the button is a switch between the levels. If both level A and level B are enabled, the levels are pulsed between the two indefinitely or for a specified number of cycles. For the stepped levels, Arbitrary and Sweep, an Interleaved button appears between A and B to enable interleaving, as shown in Figure 5-16 Stepped Levels Arbitrary and Sweep:



Figure 5-16 Stepped Levels Arbitrary and Sweep

Touch the Interleaved button to switch from pulsing to interleaving.



OCP and OPP will not be available if pulsing is selected.

Touch a mode label to allow selection of the level mode:

- 1) Basic
- 2) Table
- 3) Arbitrary
- 4) Sweep
- 5) Short
- 6) Open
- 7) OCP
- 8) OPP

### 5.2.1.1 Basic Loading

For the Basic level, the user can select the limits to apply, and for an enabled limit, the value can be set. Open and short only allow a timing configuration if pulsing is selected.

### 5.2.1.2 Table

The Table mode is shown as a summary with a Configure button that opens a dialog box for changing the settings, as shown in Figure 5-17 Level A Table Screen:



Figure 5-17 Level A Table Screen



Pressing the **Clear** button will temporarily result in an error, because a table requires at least one entry.

The configuration requires a voltage minimum ( $V_{min}$ ), below which the loading current will be zero. There is a maximum power setting ( $W_{max}$ ) that limits the loading power. The Time setting is used when pulsing and sets the time at this level. Each point is a voltage/current pair – there must be at least one point. The series of points describe a curve for the loading current, depending on the voltage.



**Add Point** – Add a table step. This button will only be available if the number of points is less than the maximum allowed (100 points). The user enters a voltage/current pair. The new step's voltage value must be greater than  $V_{min}$  by at least 1mV, and the difference between the voltage value and any other point's voltage must be greater than 1mV. When the point is complete, it will be inserted in the table's ordered list.



**NOTE**

At least one point is required for the configuration to be saved.



**Delete point** – deletes the point under the cursor.



**Shift the cursor up** – shifts the cursor up one entry; if the cursor was already at the top of the page, it may scroll the entire list.



**Shift the cursor down** – shifts the cursor down one entry; if the cursor was already at the bottom of the page, it may scroll the entire list.



**Edit point** – allows modification of the entry under the cursor. The step's final voltage must be greater than  $V_{min}$  by 1mV, and the difference between the voltage and any other point's voltage must be greater than 1mV. When the point is complete, it may be shifted in the table's ordered list.



**Clear** – clears all table points.

### 5.2.1.3 Arbitrary

The Arbitrary mode is shown as a summary with a Configure button that opens a dialog box for changing the settings, as shown in Figure 5-18 Level A Arbitrary Screen:



Figure 5-18 Level A Arbitrary Screen

The following section describes the action associated with each button.



**Edit** – allows the entry under the cursor to be modified. See the following section and section 4 - Menu Structure for instructions on editing and changing values for an entry.



#### NOTE

The Insert Above button will only appear if the number of steps is less than the maximum allowed (100 steps).



**Insert above** – inserts an entry above the cursor. The new entry will either contain default settings or be a copy of the last edited step.



**Insert below** – inserts an entry below the cursor. The new entry will either contain default settings or be a copy of the last edited step.



#### NOTE

The Insert Below button will only appear if the number of steps is less than the maximum allowed (100 steps).



**Delete** – deletes the step under the cursor.



**Scroll to the top** – appears when the number of steps is greater than six. It will scroll the cursor to the first step.



**Scroll to the bottom** – appears when the number of steps is greater than six. It will scroll the cursor to the last step.



**Shift the cursor up** – shifts the cursor up one entry; if the cursor was already at the top of the page, it may scroll the entire list.



**Shift the cursor down** – shifts the cursor down one entry; if the cursor was already at the bottom of the page, it may scroll the entire list.



**Shift entry up one position** – Shifts the entry under the cursor up one step in the arbitrary sequence. It will take no action if the first step is selected.



**Shift entry down one position** – Shifts the entry under the cursor down one step in the arbitrary sequence. It will take no action if the last step is selected.



At least one step is required for the configuration to be saved.



**Clear** – clears all arbitrary steps.

When an entry is edited, the user has the option of creating a short, open, or basic step, as shown in Figure 5-19 Level A Edit Arbitrary Entry #. A basic step allows selection of the desired loading limits. All steps require a time period setting.



Figure 5-19 Level A Edit Arbitrary Entry #3



### 5.2.1.4 Sweep

The Sweep mode is shown as a summary with a **Configure** button that opens a dialog box for changing the settings, as shown in Figure 5-20 Level A Sweep Screen:



**Figure 5-20 Level A Sweep Screen**

The sweep type can be **Current** or **Power**. The user can press the green highlighted buttons at the left of the display to configure the underlying settings. The slope of the sweep is selected as shown in Figure 5-21 Sweep Slope:

Type	Shape
Linear	
Linear-Dual	
Log	
Log-Dual	

**Figure 5-21 Sweep Slope**

### 5.2.1.5 Short

The DL will attempt to regulate to the lowest possible resistance only limited by DL model hardware.

### 5.2.1.6 Open

The DL will regulate with a fully open circuit.

### 5.2.1.7 OCP/OPP

The OCP and OPP modes are shown as a summary with a **Configure** button that opens a dialog box for changing the settings, as shown in Figure 5-22 Level A OCP Screen:



Figure 5-22 Level A OCP Screen

The user chooses Single or Continuous testing and uses the highlighted buttons to configure the underlying settings.

## 5.2.2 General

The general settings in Figure 5-23 General Load Settings apply to all loading methods and modes.

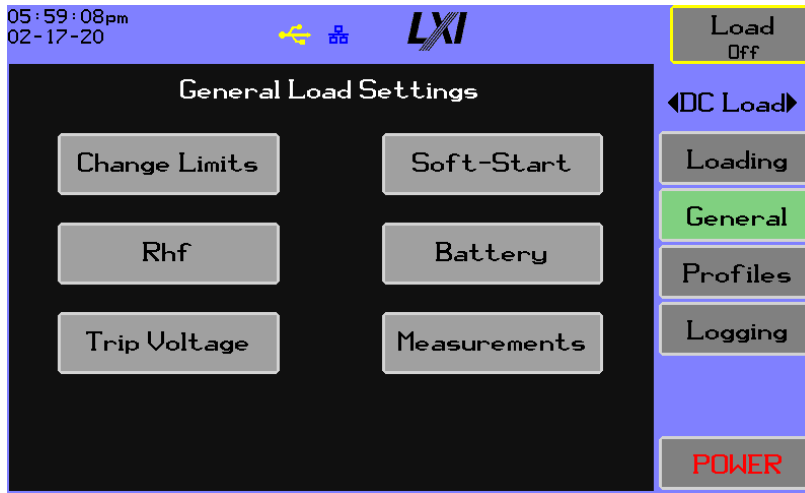

Figure 5-23 General Load Settings

### 5.2.2.1 Change Limits

Figure 5-24 Change Limits Screen configures limits on rising and falling current. The checkboxes enable application of the respective limits. If Single is selected, the configuration is used for both rising and falling current. Limits can be applied as either a Current Rate Limit or Time Constant Filter.



Figure 5-24 Change Limits Screen

### 5.2.2.2 Soft Start

Figure 5-25 Soft-Start Screen configures limits on rising and falling current. The Enable checkbox allows Soft-Start using the configured settings. The radio buttons allow for the setting to only apply while loading is active or to apply while loading is off in order to activate loading at the soft-start rate. The Ramp setting is the period that soft-start will be applied after the soft-start level has been exceeded. Soft-start will linearly increase loading from the ZERO region to the specified loading settings over the time specified in Ramp after the Soft-Start level is exceeded, unless the voltage input has been reduced below the soft-start level.



Figure 5-25 Soft-Start Screen

### 5.2.2.3 RHF

The Rhf screen, as shown in Figure 5-26 RHF Configuration is used to configure the voltage Rhf. The Rhf setting should be used to offset wiring and source impedances to be expected at 30kHz when loading in the CVR Region. See Section 2 for more details.



Figure 5-26 RHF Configuration

The user can select one of five speeds suitable for most applications, or select **User** and enter the specific simulated impedance as shown in Figure 5-27 RHF User Mode:



Figure 5-27 RHF User Mode

#### 5.2.2.4 Battery

Battery testing can be enabled as shown in Figure 5-28 Battery Testing Settings Screen, but is not allowed if the level is set to OCP or OPP. When loading is activated and battery testing enabled, the amp-hours and watt-hours are accumulated and can be found on the Numeric Results – Battery screen. Voltage Threshold sets the limit at below which the test ends, and also the threshold that must be met or exceeded by the measured voltage for the test to start. Time Limit setting allows for a safety factor that, if exceeded, causes the test to terminate early. The Enable checkbox allows battery testing using the configured settings.

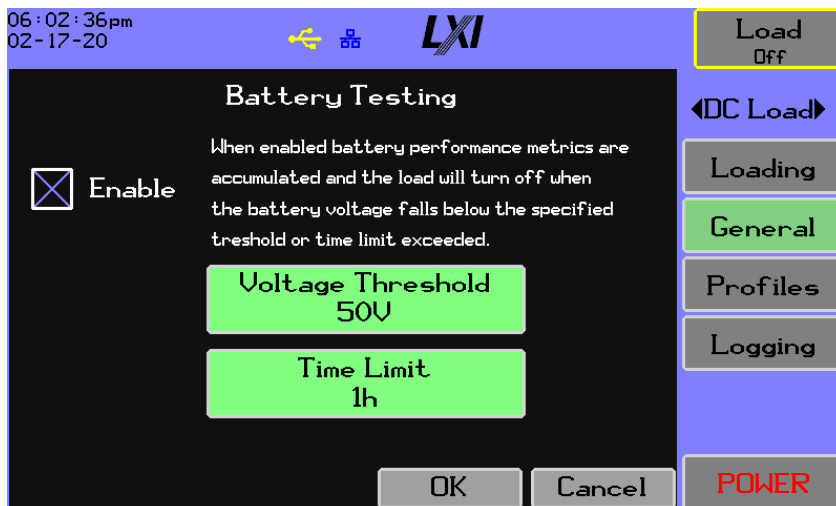

Figure 5-28 Battery Testing Settings Screen

### 5.2.2.5 Trip Voltage

This setting allows a lower limit on over-voltage detection. The unit will enter the over-voltage state if this limit is exceeded. See Section 10 Troubleshooting for more details on the Over-Voltage state.



Figure 5-29 User Trip Voltage

### 5.2.2.6 Measurement settings

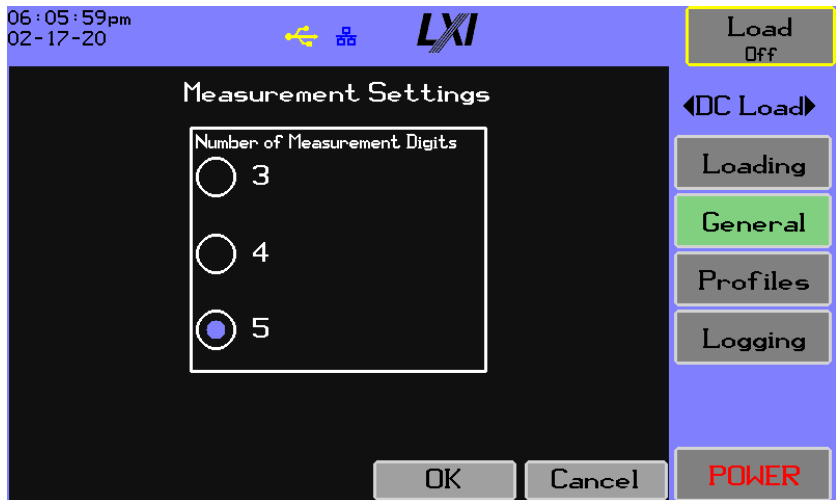

Figure 5-30 Measurement Settings

Measurement Digits: chooses a limit on the number of decimal places to use when displaying the measurements. Note that this is a restriction that can limit the internally derived representation, and in many cases, the user may show fewer digits than the unit is capable of provided. If the power supply is noisy, a smaller number of digits should be selected to allow the user to view a more stable result.

### 5.2.3 Profiles

The profile system allows the saving of the test and measurement settings to one of eight slots as shown in Figure 5-31 Save to Profile, each with a name for easy reference. The user has the option to Save or Recall a test and measurement profile, illustrated below:



#### 5.2.3.1 Save Profile

The user is presented with a list of slots with the previously saved name or (blank), indicating that the profile slot has not been used, as shown in Figure 5-31 Save to Profile. Selecting a profile slot results in a dialog box asking for the profile name, with a default of the last name used or a system-generated label. Selecting OK saves the present test and measurement settings to the slot, while selecting Cancel abandons the save.



Figure 5-31 Save to Profile

### 5.2.3.2 Recall Profile

The user is presented with a list of previously saved profiles and a **Factory** button to load the factory defaults, as shown in Figure 5-32 Recall a Profile Screen. Touching any of these buttons causes the resident test and measurement settings to be overwritten by the saved profile or factory defaults.



Figure 5-32 Recall a Profile Screen

### 5.2.4 Data Logging

This facility is different from the **Export** function available on the **Results** screen. The data log can be started to continuously store measurement data at a specified interval and will run as long as storage space is available and the unit is on, as shown in Figure 5-33 Data Logging Settings. The raw log data is always stored to the internal file system to allow the high speed available; when the logging has completed, the data must be exported to a USB drive for the user to access it.

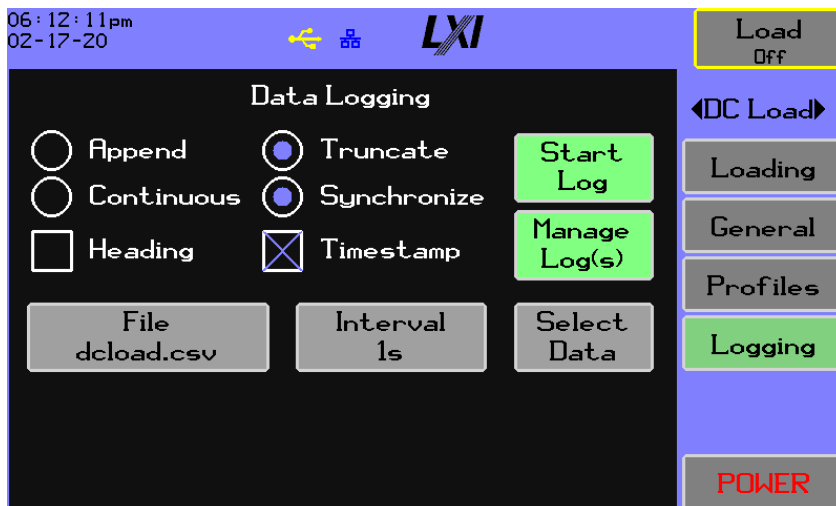

Figure 5-33 Data Logging Settings





Placing the date and time of the sample on each row typically accounts for 33% of the storage demand. Depending on the data selected for export, the date and time can account for 14% to 60% of the storage demand on the exported file.



The only file format is CSV.

**Table 5-8 Data Logging Settings**

Configuration Items	Description
Append/Truncate	Selects if the local raw file will be truncated when logging starts or if the new data will be appended. Note this affects the internal file only; the export file will always be overwritten.
Continuous/Synchronize	Selects if data will be logged continuously or only when loading is active.
Heading	Requests that the exported file have a data heading. If the internal file contains multiple start-stop cycles, there will be multiple headings.
Timestamp	Requests that the exported file have a timestamp on each row.
File	Configures the name for the internal and exported file name.
Interval	Configures the data logging interval; it accepts a setting from 1ms to 12 hours.
Select Data	Raises a dialog for selecting what will be logged; see below.

The data items for the log may be selected as shown in Figure 5-34 Select Log Data Items.



**Figure 5-34 Select Log Data Items**

Option	Description
V	Voltage
A	Current
P	Power

Ω	Resistance (Note that if the preference is set for conductance, “S” will be shown here.)
Included Extents	Selects that for each selected value the minimum and maximum extents over the interval will be recorded as well.

**Start Log** starts data logging. While logging is active, configuration options cannot be changed. While on this screen, the running log interval and file size as shown in Figure 5-35 Stop Data Logging.



**Figure 5-35 Stop Data Logging**

Also note the activity spinner on the status bar, 

The **Stop Log** button stops data logging.

Data logging cannot be started if the internal file system does not have enough free space because of past log files. These files can be managed with the **Manage Log(s)** button as shown in Figure 5-36

Manage Data Log File(s):

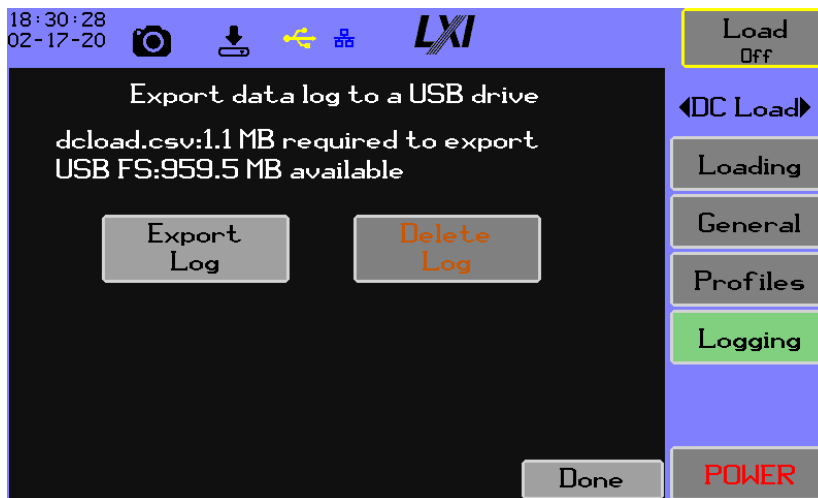

**Figure 5-36 Manage Data Log File(s)**

Selecting a file by touching the **name/time** button prompts the user to delete the file as shown in Figure 5-37 File Deletion:

**Figure 5-37 File Deletion**

If a USB drive is inserted, the **Manage Log(s)** button is replaced by the **Export Log(s)** button. If this button is pressed, the user can select a file and have the option to export or delete the file as shown in Figure 5-38 Export Log:

**Figure 5-38 Export Log**

Selecting the Export Log(s) button results in a file written to the USB drive in CSV format; the following is an example when Heading and Timestamp is selected:

```
Date/Time,Record,V:Avg,V:Min,V:Max,C:Avg,C:Min,C:Max,W:Avg,W:Min,W:Max,R:Avg,R:Min,R:Max
```

```
11-15-19
```

```
16:45:01.010,1,5.116118e+00,5.110666e+00,5.128101e+00,4.934000e-06,-
```

```
November 4, 2022
```

5.000000e-06,1.400000e-05,2.524294e-05,0.000000e+00,7.174350e-05,1.036911e+06,inf,3.657062e+05

The user should delete the log once it has been exported to prevent the internal file system from filling up.

While the export is running, a status line will show the progress, illustrated below:



The user can leave the screen and return to check the progress if it has not completed. The unit cannot be shut down while exporting.

When all four of voltage, current, power, and conductance/resistance are selected with the extents, the date/time stamp comprises approximately 12% of the storage demand when exported; when only one item is selected without the extents, the date/time stamp uses 50% of the storage.

The time it takes to execute an export to the USB drive is variable, depending on the size of the record time period, number of data items, the inclusion of extents, and the capabilities of the USB device. In particular, the speed of the USB device is not related to the brand or manufacturing date. Tests of a random selection of devices built over the last nine years are listed below for an export of 3.3 minutes of the load measurements, including extents – 20441 records.

Device	Speed (KB/sec)
SD card reader (Appotech)	338
Xitron OEM	324
ST (Alcor Micro Corp)	317
SanDisk 128	280
SanDisk 8	264
Kingston DataTraveler	260
Transcend	230
Hauppauge	225

PNY	221
Verbatim	202
SanDisk 4	181
Microsoft (Addon)	164

## 5.3 System

The system menu in Figure 5-39 About System Screen provides system-level configuration and status information.

### 5.3.1 About

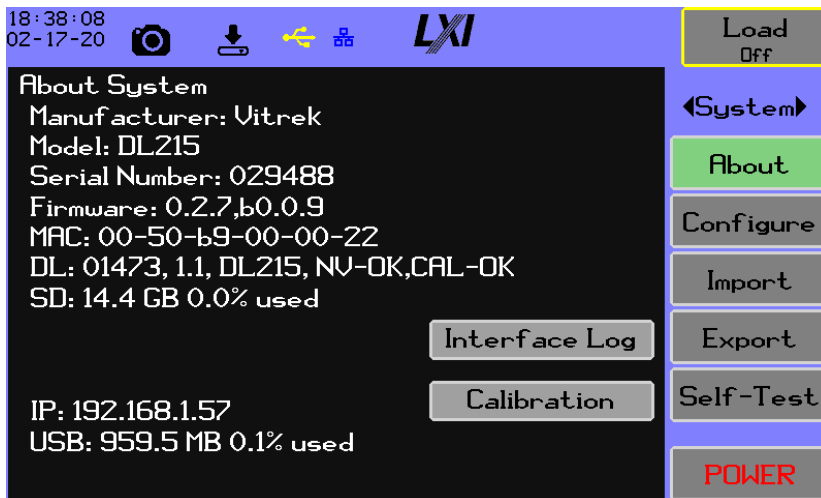

Figure 5-39 About System Screen

This is the primary screen for system status. For those items that are not self-explanatory:

Item	Description
Firmware	The version of the main application, followed by the boot loader version.
DL	Internal circuitry serial number, load processor firmware version, load PCBA model, status of calibration non-volatile storage.
SD	Size and usage of internal storage media
USB	Size and usage of the USB drive, if present

The **Interface Log** button displays the contents of the remote interface's error/event queue. This is useful information for the system's engineer when developing an integrated test environment.

The **Calibration** button allows access to a password-protected facility supporting unit calibration.

The **Update** button is presented if a USB drive containing an operating system update is inserted.

### 5.3.1.1 Firmware Update

This section outlines the steps and screens a user will see when updating the firmware.



Figure 5-40 System Update in About Menu

Pressing the **Update** button prompts the user to install the files as shown in Figure 5-41 Update - Install Files. Pressing **Install Files** causes the DL system to be updated.



Figure 5-41 Update - Install Files



#### CAUTION

The DL should not be powered off during the firmware update, otherwise damage to the instrument could occur.



#### NOTE

The install process updates all files regardless of version. The user should reboot immediately after the files have been copied.

A status screen is displayed while the firmware update is installed, listing the files as they are copied into internal memory. Once the update is completed, **Reboot Now** and **OK** buttons will be displayed, as

shown in Figure 4-43, Update Firmware Status. It is recommended that you use the Reboot button at this time.



Figure 5-42 Update Firmware Status

### 5.3.2 Configuration Menu

The Configuration screen is the main menu for configuring system-wide settings. The options shown in Figure 5-43 Configuration Screen are explained in the following sections.

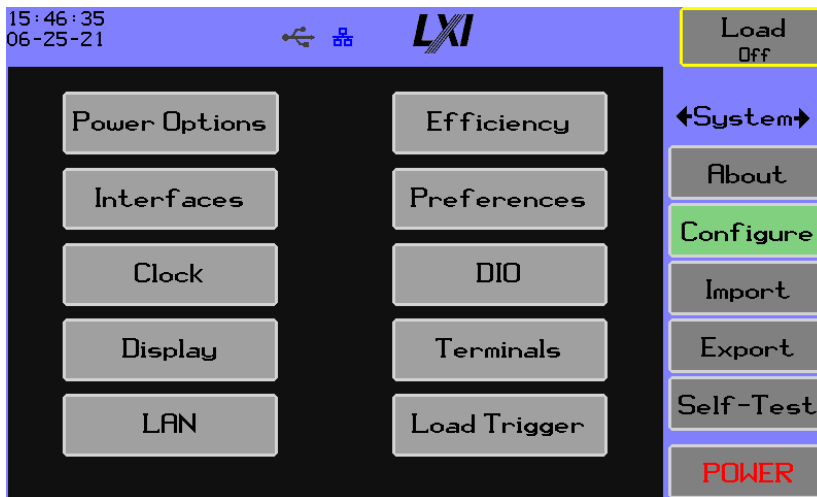

Figure 5-43 Configuration Screen

### 5.3.2.1 Power On Options

The Power On Options seen in Figure 5-44 Power On Options Screen control how the unit is powered on and off; and whether the unit stays powered on (unless it is unplugged).



**Figure 5-44 Power On Options Screen**

The options are as follows:

- Normal – On/Off by front panel touch screen. Recommended for bench-top applications.
- Auto-On – On when Mains first applied. On/Off by front panel touch screen.
- Always-On – Always on whenever Mains applied. Recommended for embedded applications.
- Factory – Load settings are the factory defaults.
- Last Used – The last used settings are used.



If the setting is set to Factory, the user cannot save settings.



### 5.3.2.2 Efficiency

This screen is used to configure the efficiency measurement facility where the DL is integrated with an external power analyzer or the internal Watt Meter.

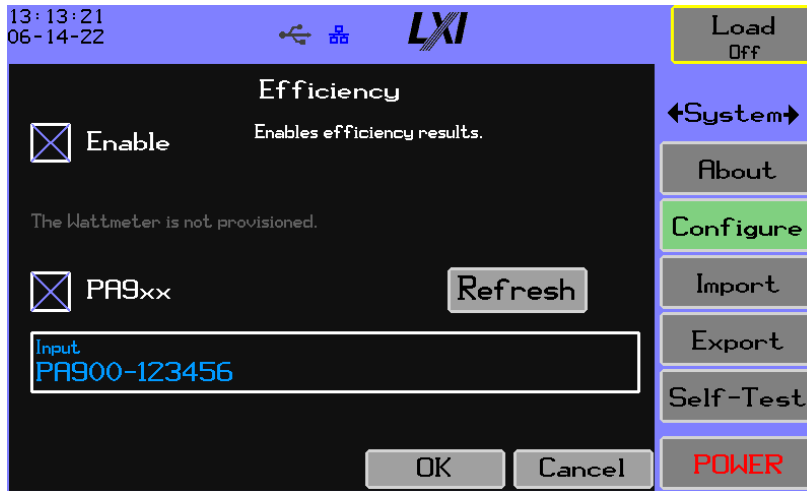

**Figure 5-45 Efficiency Options Screen**

If the feature is enabled the user has the option of integrating with the internal Wattmeter (if it is installed) or a PA9xx series power analyzer. In the latter case you can use the Refresh button to list available instruments. When the feature is enabled, the **Efficiency** option is available in the numerical results display. Refer to section 9 - Efficiency Measurement Integration for information regarding integration with a PA9xx power analyzer.

### 5.3.2.3 Interface Options

The screen in Figure 5-46 Interface Options Screen configures the interface for remote control. Refer to Section 6 - Remote Operation for more information on the commands for the DL.

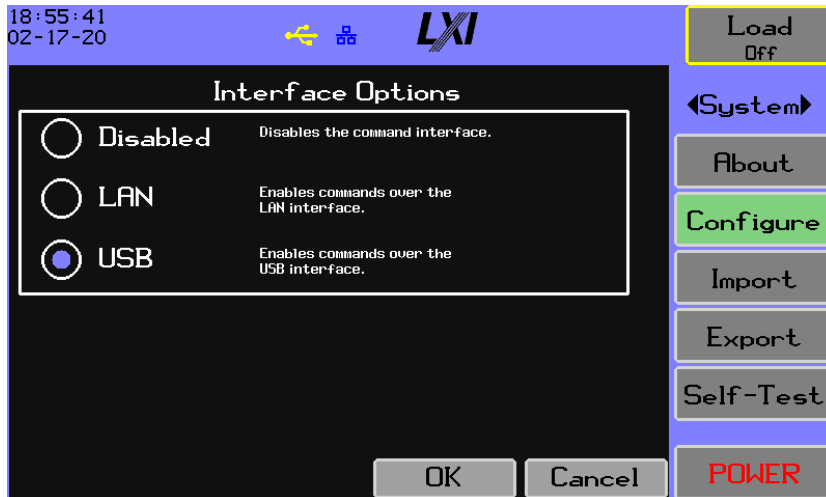

Figure 5-46 Interface Options Screen

The interface options are as follows:

- Disabled – The command interface is disabled.
- LAN – After plugging in a network cable and proper addressing, commands can be sent to the DL.
- USB – Plug the instrument into a computer using the USB device port to allow commands to be sent.

Note that if the **Disabled** option is selected the LXI logo will gray out.

### 5.3.2.4 Result Preferences

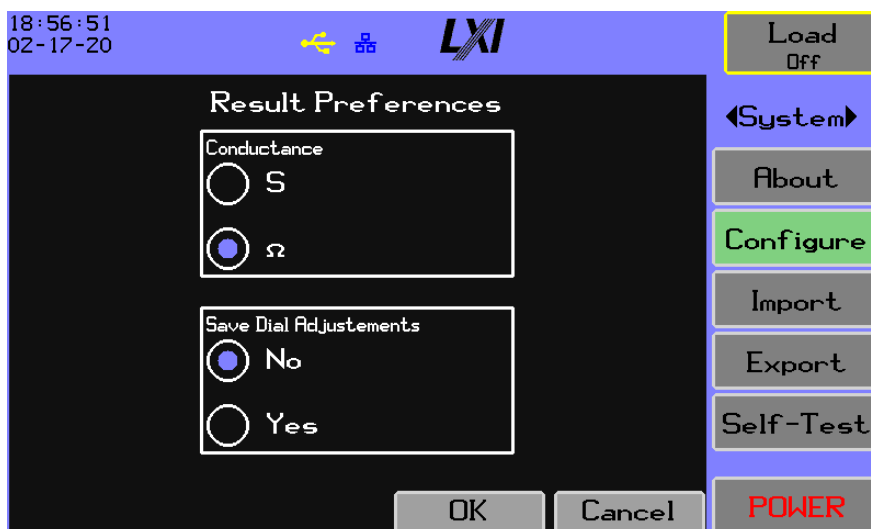

**Figure 5-47 Result Preferences Screen**

The screen in Figure 5-47 Result Preferences Screen is used to configure user preferences in the display of measurements and the operation of the dial.

- Conductance – chooses if Siemens or Ohms is to be used for display and configuration.
- Save Dial Adjustments – normally, the dialed loading adjustments are discarded when loading is turned off or changed in the configuration menus; set this to **Yes** to allow the settings to be saved automatically.

**5.3.2.5 Clock Settings**

The screen in Figure 5-48 Clock Settings Screen sets the date/time and selects how the date/time are formatted on the display and in the Comma Separated Value (CSV) export files.



**Figure 5-48 Clock Settings Screen**

### 5.3.2.6 DIO Settings

The DL has two discrete connections on the back that support a wide variety of functions to control the loading activities as well as sense the instrument's status, illustrated here:

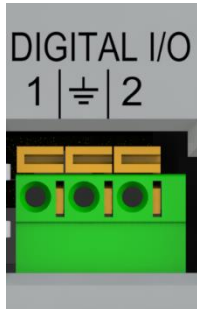

Both connections are fully symmetric in that any available function can be selected and polarity can be high or low. The functions are described in section 7.1. A typical configuration would be to use one signal to control loading, and the other to signal when loading is active:



Figure 5-49 DIO Settings

The top button is used to select the mode, the lower button selects the active polarity, the present signal state is shown at the bottom.



To allow DIO to activate loading the Load Trigger setting must be set to **External**.

The DL presents this screen to select a mode:



Figure 5-50 DIO Mode Setting

### 5.3.2.7 Display

This screen is used to configure display behavior and color theme. The Auto-dim feature in Figure 5-51 Display Screen allows selection of dimming times of five or thirty minutes after screen inactivity, increasing the life of the backlight. The Brightness setting controls the brightness of the display and may be range-limited to a specific display model. The themes are choices for the UI colors illustrated on the next page.

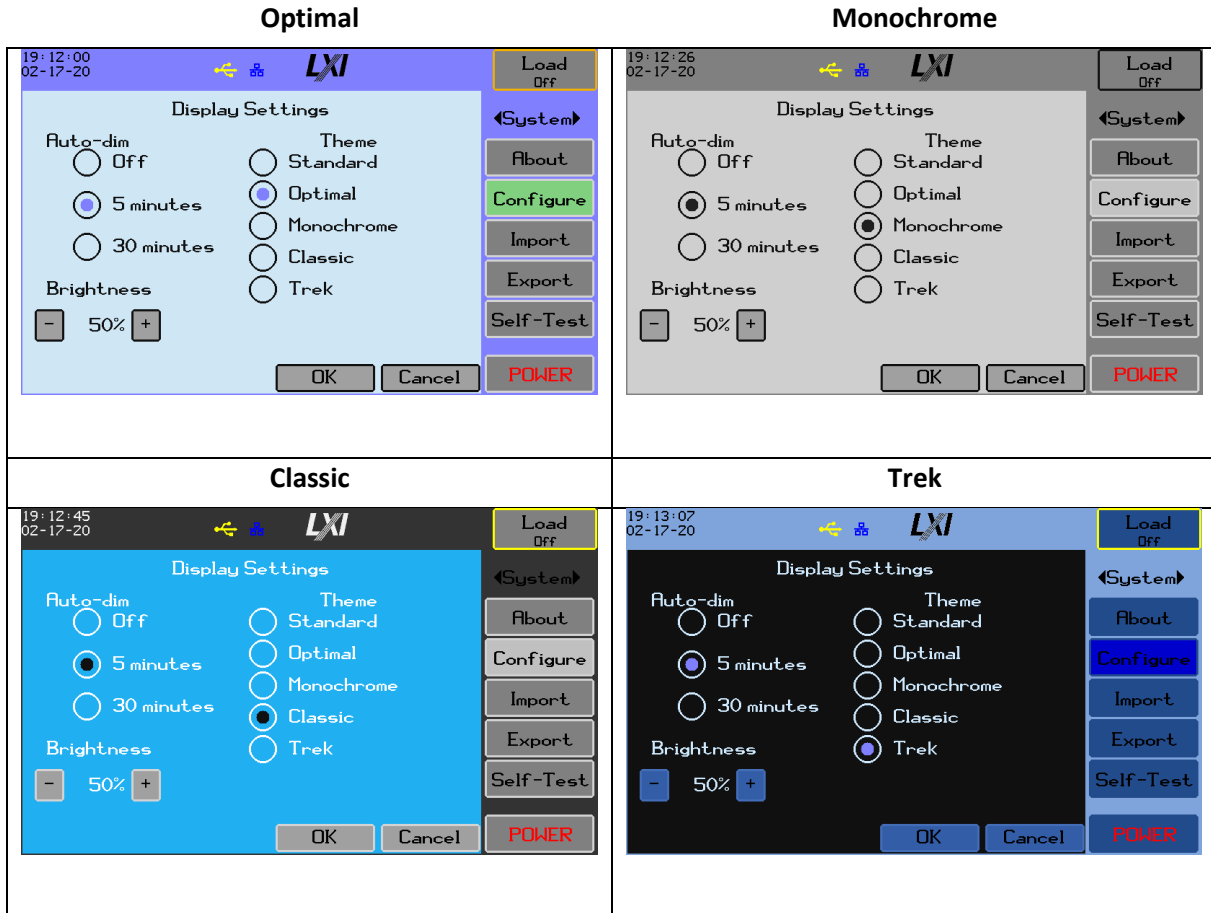

Figure 5-51 Display Screen

### 5.3.2.8 Themes

The DL has five built in themes and an option for a user theme. Visit the Vitrek web site to create your own theme. The built-in themes are described in the following table:

Theme	Description
Standard	A color set conforming to the Vitrek standard color set. The Standard theme is used throughout this manual.
Optimal	A brighter display helpful in well lighted workspaces such as some labs.
Monochrome	Mostly shades of gray suitable for color blind individuals.
Classic	A color set similar to the colors seen when instruments first started using color displays.
Trek	A darker set of colors useful in dimmer workspaces.



### 5.3.2.9 Terminal Settings

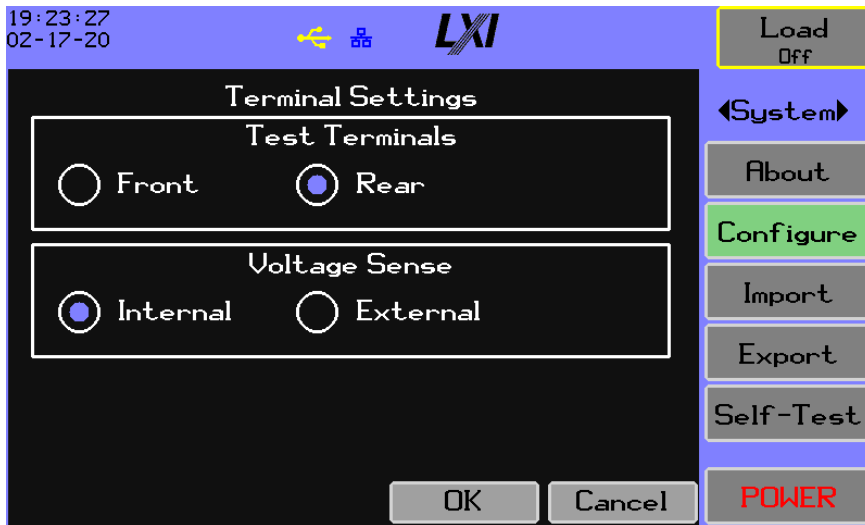

**Figure 5-52 Terminal Settings**

The screen in Figure 5-52 Terminal Settings configures the physical connections and the associated measurement behavior.

Test Terminals – chooses if the Front or Rear terminals are to be used.

Voltage Sense – chooses if voltage should be sensed from an external connection or from the test connections.

### 5.3.2.10 LAN Configuration

#### 5.3.2.10.1 Automatic Settings

The network interface can be configured automatically or manually; Automatic is illustrated in Figure 5-53 LAN Configuration Screen:



Figure 5-53 LAN Configuration Screen



When the LAN is set to Automatic, the user can utilize one or both of DHCP and Auto-IP, but at least one must be selected.

The DL can be configured to automatically obtain a network address by selecting Automatic, or the user can manually configure the unit for network operation by selecting Manual. The following options apply to either Automatic or Manual configuration.

- The **mDNS** option enables multicast DNS (mDNS) operation. The unit will announce service capabilities and respond to mDNS name and service queries. See appendix A for details on useful mDNS features helpful in the lab or production environment.
- The **Hostname** and Service buttons respectfully allow the network hostname and service name to be configured. See appendix A for details on how the names are applied. If you type a blank hostname or service name, the factory default will be applied as necessary. The character set available for the names is restricted to those allowed for internet naming.

The **LAN Reset** button can be used to reset the network interface settings to the factory defaults excepting the host and service names. The web username and password will also be restored to the factory defaults. When pressed, the button will change to an “Are you sure?” prompt, as shown in Figure 5-54 LAN Configuration Factory Reset Confirm:





**Figure 5-54 LAN Configuration Factory Reset Confirm**

When the “Are you sure?” button is pressed, the settings are reset, and a banner is displayed for two seconds as the LAN interface is reconfigured: **LAN Resetting**.

#### 5.3.2.10.2 Manual LAN Settings

If the **Manual** radio button is selected, the user is required to enter proper values for the IP address, subnet mask, and gateway address for the interface to operate properly.



Only IPv4 addresses are supported at this time.

When the Manual configuration is selected, enter the IP Address, Subnet and Gateway by pressing the appropriate button on the LAN Configuration screen, as show in Figure 5-55 LAN Configuration – Manual Setting.



**Figure 5-55 LAN Configuration – Manual Setting**

If the manual configuration has not been previously set it will default to values acquired by the last successful DHCP registration.

### 5.3.2.11 Load Trigger

The load trigger option restricts what actions may or may not activate the loading function.



**Figure 5-56 Load Trigger Options**

The effect of **External** or **Command** is the disabling of the front panel for activating the load function, DIO activation will only operate when **External** is selected.

If the Button trigger option is selected and the front panel button is used to activate loading, a **GO** button will be shown on a results screen that must be pressed to activate the loading function, as shown in Figure 5-57 Real-Time Loading Screen.



Figure 5-57 Real-Time Loading Screen

### 5.3.3 Export/import settings

The DL provides a mechanism to save configuration settings to a USB drive and restore the settings at a future time. The files are in a format suitable for import. Except for the LAN settings where there might be an IP address conflict, the import can be shared among multiple DL units. The files use an extension of “.dcl”. When Import is selected the user has the option to perform a **Factory Reset** which effectively resets all settings to the factory defaults. If Import is selected the user will be prompted to insert a USB drive if none is present.

The Import process will display a list of files available on the USB drive:



Once a file is selected the contents are read in and will replace the resident settings:

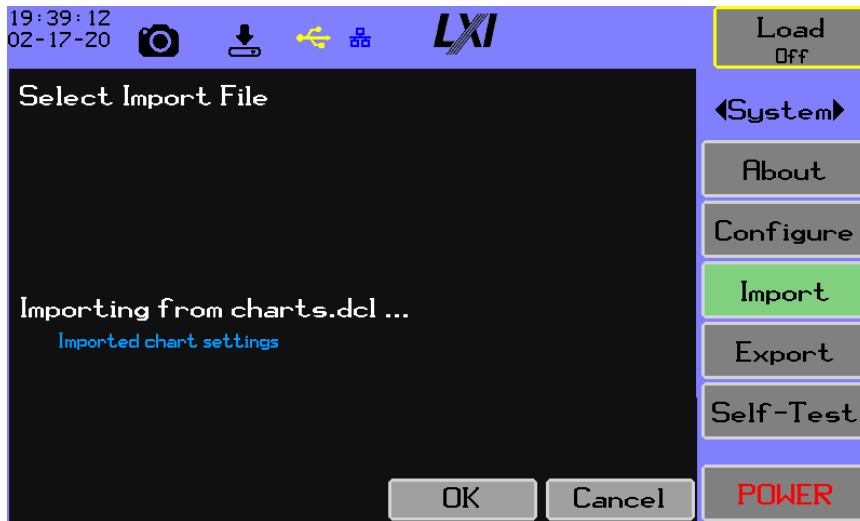

If a file contains multiple sections, the report might look like:

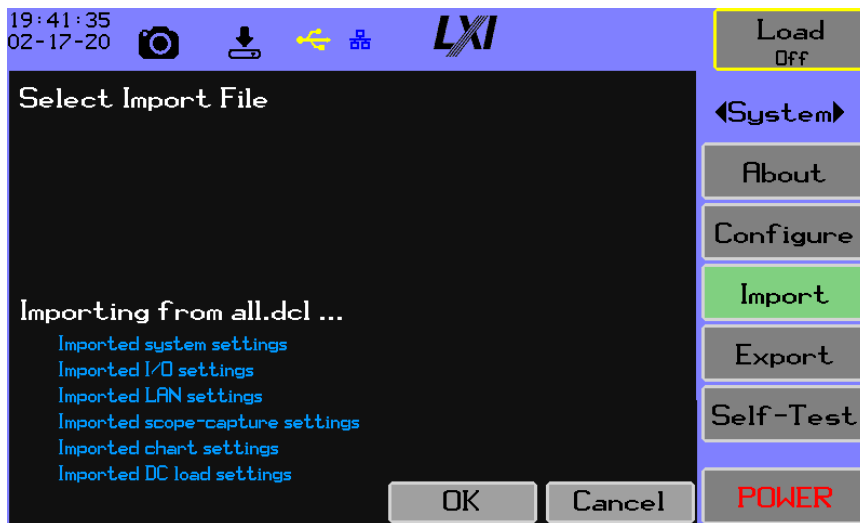

Note that if the imported file contains display settings the screen will briefly blank as the color set is applied.

### 5.3.3.1 Export



**Figure 5-58 Export Settings Screen**

The screen in Figure 5-58 Export Settings Screen allows the selective export of the configuration settings suitable for an import. Once a selection is made, the user enters a name that will be concatenated with “.dcl” and written to the USB drive with the settings.

### 5.3.4 Self-Test

The user is prompted to confirm the state of the unit and press **Start** to initiate the test cycle, as shown in Figure 5-59 Self-Test Screen.

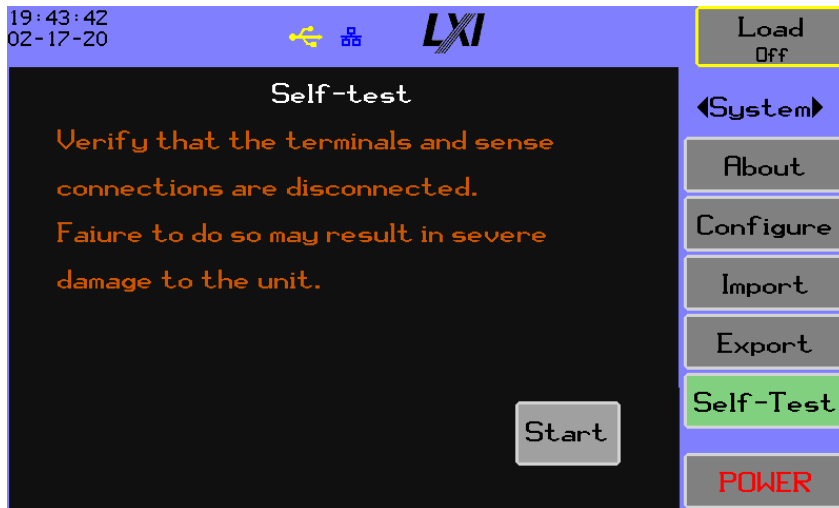

Figure 5-59 Self-Test Screen

If any voltage is sensed on the terminals, the test will not be allowed, as shown in Figure 5-60 Self-test Cannot Start.



Figure 5-60 Self-test Cannot Start

The user should remove the external voltage and press **Retry**.

While the test is running, the menu buttons will not be available.

The first stage of the self-test is to verify the operation of the fans. They are run at full capacity for up to 3 seconds and their RPM is verified; this portion of the test cannot be interrupted. The remaining test steps can be interrupted by pressing the **Abort** button to halt the procedure as shown in Figure 5-61 Self-test Running.



Figure 5-61 Self-test Running

Once the test completes successfully, the user can press the **Exit** button and resumes operation as shown in Figure 5-62 Self-Test Results.



Figure 5-62 Self-Test Results

In the event Self-Test fails, the display would be as shown in Figure 5-63, Self-test Failed



Figure 5-63, Self-test Failed



## 6 Remote Operation

### 6.1 Computer Control of the DL

There are a great many software languages, compilers, and development platforms. It is beyond the scope of this document to attempt to provide you with complete assistance regarding writing software to control the DL, so it is described in general form. Examples, where given, use the Microsoft Visual Studio Express 2012 development platform and the VB.NET language or Python 3.8. The examples are portions of code and in practice you may wish to provide handlers for recovering from timeout errors.

The protocol used for communications is entirely ASCII based, using the commonly used command and data fields approach, and is the same protocol for all interfaces.



Use of the DL via an interface is not dependent on the DL front panel being set to any specific screen. An interface must have been enabled, see section 5.3.2.3.

#### 6.1.1 LAN (Ethernet) Interface

Speed	10baseT or 100baseTX, auto selected
Duplex	Half or full-duplex, auto-selected
MDI/MDIX	Auto selected
Protocols	ICMPv4, ARP, UDP/IPv4, TCP/IPv4, DHCPv4, mDNS, IGMPv3 (reducing to v1 or v2 automatically as needed)
TCP Port	10733
Max. MTU	1500 (maximum Ethernet payload)
Remote Connections	Only one remote connection is allowed at any given time
Connector	RJ45
Cable required	CAT5 or CAT5e, UTP or STP
Cable Length	<100m (per standard)

#### 6.1.2 Connecting to the LAN Interface

The LAN connector located on the rear panel of the DL must be connected to your network or connected to a computer either directly or through a switch (a hub is not recommended). Standard CAT5e UTP cable is sufficient for the majority of applications and the DL has auto MDI/MDIX, so the use of a crossover cable is not necessary.

#### 6.1.3 IP Addressing

The LAN interface of the DL uses IP communications, an IP address must be assigned in some manner to the DL. There are three methods of doing this as described below:

1. Using a manually entered IP address, gateway, DNS server, and subnet mask.

2. Using an IP address, gateway, DNS server, and subnet mask obtained from a DHCP server (all four must be provided by the server).
3. Using an IP address obtained by the Auto-IP method (RFC3927). The IP address will be in the range from 169.254.1.0 to 169.254.254.255.

Whichever method is used, you should note the IP address of the instrument and use that address to communicate with the DL via the LAN interface. If you use a fixed manually entered IP then this will not change unless the manual configuration of the DL is changed, however using DHCP it may occasionally change (depending on the specific DHCP server, it may issue the same IP address each time or it may not) and using Auto-IP it will never be the same IP address each time that the DL is linked. The actual IP address of the instrument can be viewed by navigating to System->About.



If using Auto-IP then the traffic to and from the DL should not be able to pass through a router, so the DL must be local to the computer.



If using DHCP or Auto-IP, then it may take some time to obtain a valid IP address after attachment to the network. This typically takes a few seconds but can occasionally take considerably longer.



The DL does not support generating VLAN traffic, and although it can receive VLAN formatted traffic it ignores the VLAN information. If used on a network which uses VLAN then it should be located on a portion of that network which does not have the VLAN content. Check with your IT department regarding this if necessary.

#### 6.1.4 Writing Software to Control the DL via LAN

All network communication with the DL uses TCP/IP port 10733. The DL only allows one active socket at any given time, so you should close the TCP/IP socket when finished using it. To avoid unnecessary lockouts, the DL will allow a replacement socket if the previously active socket is still open but has not been active for >1 minute, in which case it will close the expired socket (this only occurs if a new socket is attempted, otherwise the DL will keep a socket open even if it is not active).

TCP/IP has CRC error checking, packet loss detection, and automatic retransmission of lost or corrupted data. This means that the user need not perform error checking using commands such as *SYSTEM:ERROR:ALL?* when using the LAN interface except for testing your software, as each command is guaranteed to reach the DL without error.

#### 6.1.4.1 VB.NET Example

Before your software can communicate with the DL it generally must create an object for the socket and then configure and open it. Presume for the example you have a dialog entry box named

***EnetIPAddrBox.***

```
Dim enet_socket As System.Net.Sockets.TcpClient
enet_socket.Connect(System.Net.IPAddress.Parse(EnetIPAddrBox.Text),
10733)
enet_socket.ReceiveTimeout = 1000
```

To close the socket the following is an example.

```
enet_socket.Close()
```

The example above shows using the IP address of a DL to open a connection to it. Alternatively, the identity name of the DL can be used, but with '.local' appended to the end of it, as an example if the DL identity is DL150-123456 then a socket with it can be opened using –

```
enet_socket.Connect("DL150-123456.local", 10733)
```

Opening a socket using the identity name has the advantage that you do not need to know the IP address of the instrument, only its' identity name, so your software does not need to be modified to accommodate changes to the network configuration.

Since the DL communicates entirely using the standard ASCII character set, methods for sending and receiving character strings must be used, remembering to always terminate both transmitted and received strings with the <CR> and/or <LF> characters.

To transmit a command string (TransmitString) to the DL the following is an example –

```
Dim send_data As Byte() =
System.Text.Encoding.ASCII.GetBytes(TransmitString + Chr(10))
Dim send_len As Integer = cmd_string.Length
enet_socket.GetStream.Write(send_data, 0, send_len + 1)
```

To receive a response string (ReceiveString) from the DL the following is an example –

```
Dim sr As New System.IO.StreamReader(enet_socket.GetStream())
Dim ReceiveString as String = sr.ReadLine()
```

### 6.1.4.2 Python 3.8 Example

```
import sys
import socket

arguments = len(sys.argv)
if arguments > 1:
    sock = socket.socket( socket.AF_INET, socket.SOCK_STREAM )
    sock.settimeout(2)
    try:
        sock.connect( (sys.argv[1], 10733) )
    except OSError as msg:
        print( "cannot connect" )
        sock.close()
        sys.exit()

    sock.send( "*IDN?\r".encode() )      # Send *IDN?\n
    datab=sock.recv(8192)              # Read the response
    data = datab.decode("utf-8")[:-2]   # Strip \r\n
    print( "Identity", data )

else:
    print( "Usage: ", sys.argv[0], "address" )
```

### 6.1.5 USB Interface

Connector	USB B connector
Cable required	USB 2.0 A-B Cable
Compatibility	Compatible with Windows XP and later operating systems
USB Speed	Full-speed
USB Device	Enumerates as a Virtual COM Port
Driver	None required for Windows 10, see appendix B for other versions of Windows.

#### 6.1.5.1 Connecting to the USB Interface

The USB connector located on the rear panel of the DL must be connected to the computer or a hub using a standard USB AB type cable. The use of a quality cable is particularly recommended if interference is likely, as lower quality cables have poor shielding (if any) and have a high RF impedance in the ground connection.

The DL uses drivers built into the most common operating systems and does not use a vendor supplied driver. When the DL is first connected to a computer (sometimes to each specific USB port of a computer) the operating system of the computer must load its native VCP device driver, this may take a short while. During that time, the DL cannot be communicated with via the USB. The DL appears as a standard Virtual COM port. It is shown in the Windows Device Manager as a Virtual COM Port.

**NOTE**

For Windows 10, Mac OS, and Linux, no install is required. For pre-Windows 10 Operating Systems, INF files are required for installation of the USB drivers for communicating with the DL. See appendix B for detailed instructions.

### 6.1.5.2 Writing Software to Control the DL via USB

Before your software can communicate with the DL it generally must create an object for the specific serial port and configure it.

#### 6.1.5.3 VB.NET Example

As an example, the following lines of code configure and open the port for communications (SerialPort1 is defined as a System.IO.Ports.SerialPort object) -

```
SerialPort1.BaudRate = 115200
SerialPort1.PortName = "COM1"
SerialPort1.ReadTimeout = 100
SerialPort1.WriteTimeout = 100
SerialPort1.Open()
```

Since the DL communicates entirely using the standard ASCII character set, methods for sending and receiving character strings must be used, remembering to always terminate both transmitted and received strings with the <CR> and/or <LF> characters.

To transmit a command string (TransmitString) to the DL the following is an example –

```
SerialPort1.WriteLine(TransmitString)
```

To receive a response string (ReceiveString) from the DL the following is an example –

```
Dim ReceiveString as String = SerialPort1.ReadLine()
```

#### 6.1.5.4 Python 3.8 Example

You will have to install the pySerial module.

```
import sys
import serial

arguments = len(sys.argv)
if arguments > 1:

    try:
        comport = serial.Serial( sys.argv[1], 115200, timeout=1 )
    except SerialException:
        print( "cannot open port" )
        sys.exit()

    comport.write( "*IDN?\r".encode() )           # Send *IDN?\n
    read_val = comport.read_until()              # Read up until \n
    response = read_val.decode("utf-8")[:-2]     # Strip \r\n
```

```
print( "Identity", response )  
  
else:  
    print( "Usage: ", sys.argv[0], "com-port" )
```

---

## 6.2 IEEE488.2 Compatibility

---

The DL is largely compatible with mandatory portions of the IEEE488.2 standard.

---

## 6.3 SCPI 1999.0 Compatibility

---

The DL is largely compatible with SCPI version 1999.0 and uses a command tree.

---

## 6.4 Command Syntax

---

All commands to the DL use the standard 7-bit ASCII character set using 8-bit encoding (the 8th bit is zero) independent of the actual interface being used. A command is a stream of characters, the DL storing received characters until a command terminator character is received and then action is taken on the commands. Further characters may be received while the DL is taking the actions needed for a preceding command, but no action will be taken on them until all pending command decode activity is completed.

Each command is a KEYWORD field defining the command possibly followed by further fields which refine the action of the command. The available command keywords and the fields required for each are described in tables later in this section.

More than one command can be present in a single command set, in which case each command is separated from the previous by a command separator character. If an error is found in any command within a command set, then that command and any remaining commands which follow it in the command set will not be actioned.

Since the interface is based on streaming ASCII characters the use of separator and terminator characters is required to ensure that the extents of each field can be established. To improve the readability of commands you may also wish to employ whitespace characters to spread apart fields.

### 6.4.1 Command Errors

If in the processing of a command an error is encountered no response is transmitted and further command processing is halted. After every command, the error/event queue should be queried to determine if an error occurred.

### 6.4.2 Special Characters

Certain ASCII characters serve a special purpose as described below.

#### 6.4.2.1 Command Terminator Characters

The end of a command set is determined by the presence of a command terminator which may be the line feed, carriage return, form feed, or NUL (0 value) ASCII characters.

Everything between successive command terminators is a command set. A command set is limited to a maximum of 2000 characters in total. There is no action taken or error generated if a command terminator is immediately followed by another command terminator.

#### **6.4.2.2 Command Separator Character**

If more than one command is in a command set, then each successive command is separated from the previous by a command separator which is the semi-colon ASCII character (;).

Everything between successive command separators or command terminators is a command. There is no action taken or error generated if a command separator is immediately followed by another command separator or a command terminator.

#### **6.4.2.3 Field Separator Character**

Many commands require one or more fields which refine the action of the command; each field is separated from the previous by a field separator which is the comma ASCII character (,).

Everything between successive field separators, command separators or command terminators is a field.

#### **6.4.2.4 Whitespace Characters**

Most fields and sub-fields can have one or more whitespace characters at the beginning and/or end. The space, tab and underscore ASCII characters are considered as whitespace characters.

### **6.4.3 Fields within a Command**

Command fields are one of the types described below. In certain cases, a single field may be formed by multiple sub-fields, in which case each successive sub-field (each having one of the field types described below) is separated from the previous by a preceding sub-field separator character.

#### **6.4.3.1 KEYWORD Command Field Syntax**

A KEYWORD field is a combination of printable ASCII characters which match the corresponding allowable keywords as described later. A KEYWORD field is not case-sensitive (e.g., the letters V and v are equivalent) and may be preceded and/or followed by one or more whitespace characters but may not contain any whitespace characters within it.

Examples of valid KEYWORD fields are –

```
*CLS
*cls
*Cls
BASIC
basic
OCP
```

Ocp

SOURce:COMMon:VBW

SOURce:STATe

MEASure:SCOPE:RUN

#### 6.4.3.2 STRING Command Field Syntax

A STRING field is any combination of any printable ASCII characters in the range 'a' through 'z'. A STRING field is literal, containing the exact definition of the required string.

Note that STRING fields are only terminated by a command terminator or separator character and may contain what would normally be any other separator character (if printable).

Examples of valid STRING fields are –

- On
- always
- POWER

#### 6.4.3.3 NR1 Command Field Syntax

A NR1 field is any combination of ASCII numeric (0 through 9) characters which form an integer value. A NR1 command field must not include a polarity character. A NR1 field may be preceded and/or followed by one or more whitespace characters but may not contain any whitespace characters within it.

All NR1 fields must be in the range 0 to 4294967295 and will cause a syntax error if outside of this range and in most commands this range is further limited and will cause a data range error if that range is exceeded.

Examples of valid NR1 fields are –

- 10
- 153465782

#### 6.4.3.4 NR3 Command Field Syntax

A NR3 field is any combination of ASCII characters which form a floating point value. A NR3 field may be preceded and/or followed by one or more whitespace characters but may not contain any whitespace characters within it.

All NR3 fields are decoded and used within the DL with approximately 1 in 107 resolution and unless otherwise started may be in the range 0 to 10+99 and may contain a number of characters which is only limited by the maximum length of a command set.

Examples of valid NR3 fields are –

- 10
- 10.0
- +10.0
- 1e1



- -10.0
- +1.2345678E+6
- +1.2345678e+6
- +1.2345678e-6
- +1.2345678e6
- 153465782.34

#### 6.4.3.5 Boolean Command Field Syntax

Many commands accept a setting that enables or disables; turns on or off; or activates/deactivates a function or feature. The keyword takes one of the following forms:

Keyword	Effect
0 (zero)	Disabled/Off
Off	Disabled/Off
N	Disabled/Off
Non-zero	Enabled/On
On	Enabled/On
Y	Enabled/On

#### 6.4.3.6 Time interval set to command/hold

Several loading operations operate over a specified time interval or can be held until a command is sent to advance the level. When specifying this parameter, the value is either in the form of an NR3 or the keyword Command.

#### 6.4.3.7 Invalid results

When requested numeric data is not available a value of 9.91E37 is reported. See SCPI version 1999.0 volume 1 section 7.2.1.5 for further information.

---

## 6.5 Responses to Commands

---

Some commands cause the DL to respond with a requested data response or set of data responses. The response is formed by a set of fields, similar to those for commands described above.

Note that all command keywords which end with the ? character cause a response; all command keywords which do not end with the ? character do not cause a response.

All responses from the DL use the standard 7-bit ASCII character set using 8-bit encoding (the 8th bit is zero) independent of the actual interface being used.

You may request more than one response in a set of commands, in which case each response (or set of responses) is separated from the previous by a semicolon separator and the responses are included in

the same order as they were requested. A complete response is always terminated by a carriage return followed by a line feed ASCII character and may contain up to 1 million characters in total.

It is expected that after a command is given to the unit to produce a response that the originator will not issue further commands requesting a response until that prior response has been fully received. If the unit receives a command which requests a response, but the prior response has not been fully transmitted then this raises a Tx Overrun error.

### **6.5.1 Response Fields**

As defined for each such command a response is one or more fields, each of which is of the following types.

#### **6.5.1.1 STRING Response Field Syntax**

A STRING response is a set of ASCII characters forming the response. Only printable ASCII characters are used, and the length of a STRING response is variable, the terminating comma (if more response fields follow it) or the terminating carriage-return and line-feed characters should be used to determine the end of a STRING field.

#### **6.5.1.2 NR1 Response Field Syntax**

A NR1 response is a set of ASCII numeric characters defining an integer value. The length of a NR1 response is variable, the terminating comma (if more response fields follow it) or the terminating carriage-return and line-feed characters should be used to determine the end of a NR1 field. A NR1 response never includes a polarity symbol as all such responses are positive.

#### **6.5.1.3 NR3 Response Field Syntax**

A NR3 response is a set of ASCII characters defining a floating point numeric value. The length of a NR3 response is fixed at 11 characters however it is recommended that the terminating comma (if more response fields follow it) or the terminating carriage-return and line-feed characters be used to determine the end of a NR3 field.

A NR3 response always has the following parts in the order shown –

- A polarity character, defining the polarity of the numeric
- 6 digit characters with an embedded decimal point character, defining the mantissa portion of the numeric
- The letter E character (upper case)
- A polarity character, defining the polarity of the exponent
- A single digit character defining the exponent (which is always a multiple of 3)

There is a special case of a NR3 response which is used to indicate that the data is not available. Normally a zero value uses a +0.00000E-9 response; a response of +0.00000E+0 indicates that the value is unavailable.

## 6.6 Program Messages Affecting Loading

As long as the program message syntax is valid, and the configuration is allowed a command that affects the loading activity configuration is applied upon receipt of the *program message terminator*. To illustrate this issue two examples are illustrated to explain the functionality. Presume the DC load is executing a basic/basic pulsed loading configuration with these settings:

	Level A	Level B
<b>Mode</b>	Basic	Basic
<b>CC</b>	0.2A	0.3A
<b>Hold time</b>	100ms	100ms

The user wishes to change the level B current to 0.5A and the hold time to 750ms.

Example 1 – single *program message unit per program message*

Commands:

```
SOURce:LVLB:BASic:CC:VALue 0.5
SOURce:LVLB:BASic:HOLD 0.750
```

When the first command is received the current setting is immediately applied at the 100ms pulse hold time; upon receipt of the second command the hold time is changed to 750ms.

Example 2 – multiple *program message unit per program message*

```
SOURce:LVLB:BASic:CC:VALue 0.5; SOURce:LVLB:BASic:HOLD 0.750
```

Upon receipt of this compound command the level B current and hold time are changed at the same time.

The use of the second form of *program message* is recommended when changing a table or arbitrary configuration.

## 6.7 Command Summaries

In the following tables unless otherwise noted the commands are symmetric in that they can have both command and query forms.

**Table 6-1 IEEE Mandated commands**

Command Keyword	Parameter	Description	Section
*CLS	-	Clear status command.	6.8.1.1
*ESR?	-	Standard Event Status Register query.	6.8.1.2
*STB?	-	Read Status Byte Query	6.8.1.3

Command Keyword	Parameter	Description	Section
*SRE	<i>setting</i>	Service Request Enable	6.8.1.4
*ESE	<i>setting</i>	Event Status Enable	6.8.1.5
*RST	-	Reset the DL to a known state.	6.8.1.6
*IDN?	-	Query the unique device identification string.	6.8.1.7
*OPC	-	Operation complete command.	6.8.1.8
*OPC?	-	Operation complete query.	6.8.1.9
*WAI	-	Wait-to-continue command.	6.8.1.10
*RCL	<i>n</i>	Restore test settings from store <i>n</i> .	6.8.1.11
*SAV	<i>n</i>	Save test settings into store <i>n</i> .	6.8.1.12
*SDS	-	Save the default operational test settings.	6.8.1.13
*TST	-	Executes a self-test query	6.8.1.14

**Table 6-2 System Remote Locking commands**

Command Keyword	Parameter	Description	Section
SYSTem:LOCK:REQuest? <sup>1</sup>	-	Requests to lock out the local user.	6.8.2.1
SYSTem:LOCK:RELease <sup>2</sup>	-	Enters the LOCAL state (front panel configuration changes enabled).	6.8.2.2
SYSTem:LOCK:OWNer? <sup>1</sup>	-	Reports the present state of the lock.	6.8.2.3

<sup>1</sup>Query only.<sup>2</sup>Command only.

**Table 6-3 System Event/Error Query Commands**

<b>Command Keyword</b>	<b>Parameter</b>	<b>Description</b>	<b>Section</b>
STATus:PRESet	-	Enables errors and disables all other events	6.8.3.1
SYSTem:ERRor:ALL?	-	See SCPI 1999.0	6.8.3.2
SYSTem:ERRor:CODE:ALL?	-	See SCPI 1999.0	6.8.3.3
SYSTem:ERRor[:NEXT]?	-	See SCPI 1999.0	6.8.3.4
SYSTem:ERRor:CODE[:NEXT]?	-	See SCPI 1999.0	6.8.3.5
SYSTem:ERRor:COUnT?	-	See SCPI 1999.0	6.8.3.6
SYSTem:ERRor:ENABle	codes	See SCPI 1999.0	6.8.3.7
SYSTem:ERRor:ENABle:ADD	-	See SCPI 1999.0	6.8.3.8
SYSTem:ERRor:ENABle:DELeTe	-	See SCPI 1999.0	6.8.3.9
SYSTem:ERRor:ENABle[:LIST]	-	See SCPI 1999.0	6.8.3.10
SYSTem:VERSion	-	See SCPI 1999.0	6.8.3.11

**Table 6-4 Source Loading Common Configuration Commands**

Command Keyword	Parameter	Description	Section
SOURce:METhod	A B PULSe INTerleave DISabled	Configures the loading method.	6.8.4.1
SOURce:COMMon:RHF	Ohms	Set the Rhf factor.	6.8.4.2
SOURce:COMMon:TRIP:ENABle	Boolean	Enables the user trip voltage level.	6.8.4.3
SOURce:COMMon:TRIP:LEVel	Voltage	Set the user voltage trip level.	6.8.4.4
SOURce:COMMon:PLIMit:ENABle	Boolean	Enables the pulse limit option.	6.8.4.5
SOURce:COMMon:PLIMit:COUNt	Count	Configures the pulse limit count.	6.8.4.6
SOURce:COMMon:BATTery:ENABle	Boolean	Enables the battery test function.	6.8.4.7
SOURce:COMMon:BATTery:VOLTagE	Voltage	Configures the battery test voltage level.	6.8.4.8
SOURce:COMMon:BATTery:TLIMit	Seconds	Configures the battery test time limit.	6.8.4.9
SOURce:COMMon:SOFTstart:ENABle	Boolean	Enables the soft-start option.	6.8.4.10
SOURce:COMMon:SOFTstart:COVerge	On Always	Configures soft-start coverage.	6.8.4.11
SOURce:COMMon:SOFTstart:RAMP	Seconds	Configures the soft-start ramp limit.	6.8.4.12
SOURce:COMMon:SOFTstart:LEVel	Voltage	Configures the level above which soft-start operates.	6.8.4.13
SOURce:COMMon:LIMit:RISing:FILTer:ENABle	Boolean	Enables the rising current time filter.	6.8.4.14
SOURce:COMMon:LIMit:RISing:FILTer:TIME	Seconds	Configures the rising current time period.	6.8.4.15
SOURce:COMMon:LIMit:RISing:CURREnt:ENABle	Boolean	Enables the rising current filter.	6.8.4.16
SOURce:COMMon:LIMit:RISing:CURREnt:LIMit	Amps/us	Configures the rising current limit.	6.8.4.17
SOURce:COMMon:LIMit:FALLing:FILTer:ENABle	Boolean	Enables the falling current time filter.	6.8.4.18
SOURce:COMMon:LIMit:FALLing:FILTer:TIME	Seconds	Configures the falling current time period.	6.8.4.19
SOURce:COMMon:LIMit:FALLing:CURREnt:ENABle	Boolean	Enables the falling current filter.	6.8.4.20
SOURce:COMMon:LIMit:FALLing:CURREnt:LIMit	Amps/us	Configures the falling current limit.	6.8.4.21

**Table 6-5 Source Loading Level A and B Configuration Commands**

Command Keyword	Parameter	Description	Section
SOURce:LVLA:MODE	<i>Basic Short Open Table Arbitrary Sweep OCP OPP</i>	Configure the level's loading mode.	6.8.5.1
SOURce:LVLA:BASic:CV:VALue	<i>Voltage</i>	CV voltage: the voltage below which the loading is always 0.	6.8.5.2
SOURce:LVLA:BASic:CV:ENABle	<i>Boolean</i>	Enables voltage limiting.	6.8.5.3
SOURce:LVLA:BASic:CC:VALue	<i>Amps</i>	CC current: sets the loading current.	6.8.5.4
SOURce:LVLA:BASic:CC:ENABle	<i>Boolean</i>	Enables current limiting.	6.8.5.5
SOURce:LVLA:BASic:CW:VALue	<i>Watts</i>	CW watts: sets the loading power level.	6.8.5.6
SOURce:LVLA:BASic:CW:ENABle	<i>Boolean</i>	Enables power limiting.	6.8.5.7
SOURce:LVLA:BASic:CR:VALue	<i>Siemens</i>	CR conductance: sets the maximum conductance in Siemens.	6.8.5.8
SOURce:LVLA:BASic:CR:ENABle	<i>Boolean</i>	Enables resistance limiting.	6.8.5.9
SOURce:LVLA:BASic:HOLD	<i>Seconds</i>	The amount of time this level is held when pulsing, this does not apply when the level is continuous.	6.8.5.10
SOURce:LVLA:OPEN:HOLD	<i>Seconds</i>	The amount of time this level is held when pulsing, this does not apply when the level is continuous.	6.8.5.11
SOURce:LVLA:SHORT:HOLD	<i>Seconds</i>	The amount of time this level is held when pulsing, this does not apply when the level is continuous.	6.8.5.12
SOURce:LVLA:TABLe:VMIN	<i>Voltage</i>	The voltage below which the loading is always 0.	6.8.5.13
SOURce:LVLA:TABLe:PMAx	<i>Watts</i>	The maximum loading power level.	6.8.5.14
SOURce:LVLA:TABLe:HOLD	<i>Seconds</i>	The amount of time this level is held when pulsing, this does not apply when the level is continuous.	6.8.5.15
SOURce:LVLA:TABLe:POINts:FIRSt <sup>2</sup>	<i>V,A</i>	Clears the table and sets the first point.	6.8.5.16
SOURce:LVLA:TABLe:POINts:APND <sup>2</sup>	<i>V,A</i>	Appends a [V,A] point to the table.	6.8.5.17
SOURce:LVLA:TABLe:POINts:NUM? <sup>1</sup>	-	The number of [V,A] points.	6.8.5.18
SOURce:LVLA:TABLe:POINts? <sup>1</sup>	-	The list of [V,A] settings.	6.8.5.19
SOURce:LVLA:ARBitrary:FIRSt <sup>2</sup>	<i>C,P,V,S,T</i>	Clears the list and sets the first entry.	6.8.5.20
SOURce:LVLA:ARBitrary:APND <sup>2</sup>	<i>C,P,V,S,T</i>	Appends an entry to the list.	6.8.5.21
SOURce:LVLA:ARBitrary:NUM? <sup>1</sup>	-	The number of entries.	6.8.5.22

Command Keyword	Parameter	Description	Section
SOURce:LVLA:ARbitrary? <sup>1</sup>	-	The list of entries.	6.8.5.23
SOURce:LVLA:SWEEP:MODE	<i>Current Power</i>	Selects if current or power should be swept.	6.8.5.24
SOURce:LVLA:SWEEP:TYPE	<i>Linear Linear-Dual Log Log-Dual</i>	Selects the shape of the loading curve and if the ramp should be reversed.	6.8.5.25
SOURce:LVLA:SWEEP:START	<i>NR3</i>	Starting value, cannot be 0 for a logarithmic sweep.	6.8.5.26
SOURce:LVLA:SWEEP:END	<i>NR3</i>	Ending value, cannot be 0 for a logarithmic sweep.	6.8.5.27
SOURce:LVLA:SWEEP:STEPS	<i>2..500</i>	The number of steps in the sweep.	6.8.5.28
SOURce:LVLA:SWEEP:TIME	<i>Seconds</i>	The amount of time at each step.	6.8.5.29
SOURce:LVLA:OCP:VTRIP	<i>Voltage</i>	Voltage trip level, the voltage below which the sweep is terminated.	6.8.5.30
SOURce:LVLA:OCP:MIN	<i>Current</i>	Minimum current threshold that must be exceeded for the test to pass.	6.8.5.31
SOURce:LVLA:OCP:START	<i>Current</i>	The sweep starting value in amps.	6.8.5.32
SOURce:LVLA:OCP:END	<i>Current</i>	The sweep ending value in amps, must be greater than the starting value.	6.8.5.33
SOURce:LVLA:OCP:PERIOD	<i>Seconds</i>	The time period for the sweep.	6.8.5.34
SOURce:LVLA:OCP:RECOVERY	<i>Seconds</i>	The recovery time after completing each sweep until starting the next one, it can be zero.	6.8.5.35
SOURce:LVLA:OCP:MODE	<i>SINGLE CONTInuous</i>	Selects if the OCP sweep runs once or continuously.	6.8.5.36
SOURce:LVLA:OPP:VTRIP	<i>Voltage</i>	Voltage trip level, the voltage below which the sweep is terminated.	6.8.5.37
SOURce:LVLA:OPP:MIN	<i>Power</i>	Minimum power threshold that must be exceeded for the test to pass.	6.8.5.38
SOURce:LVLA:OPP:START	<i>Power</i>	The sweep starting value in watts.	6.8.5.39
SOURce:LVLA:OPP:END	<i>Power</i>	The sweep ending value in watts, must be greater than the starting value.	6.8.5.40
SOURce:LVLA:OPP:PERIOD	<i>Seconds</i>	The time period for the sweep.	6.8.5.41
SOURce:LVLA:OPP:RECOVERY	<i>Seconds</i>	The recovery time after completing each sweep until starting the next one, it can be zero.	6.8.5.42
SOURce:LVLA:OPP:MODE	<i>SINGLE CONTInuous</i>	Selects if the OPP sweep runs once or continuously.	6.8.5.43

Replace LVLA with LVLB to configure the B level.

<sup>1</sup>Query only.

<sup>2</sup>Command only.



**Table 6-6 Loading Operation Commands**

Command Keyword	Parameter	Description	Section
SOURce:STATe	<i>Off</i> <i>On</i> <i>Arm</i>	Controls and queries the present loading state.	6.8.6.1
SOURce:ALARm? <sup>1</sup>	-	Reports the loading alarm status.	6.8.6.2
SOURce:NEXT <sup>2</sup>	<i>period</i>	Continue a pulsed, interleaved, or stepped loading.	6.8.6.3
SOURce:TRIGger <sup>2</sup>	-	Triggers the load to activate.	6.8.6.4
ABORT <sup>2</sup>	-	Disable loading and halt scope capture.	6.8.6.5

<sup>1</sup>Query only.<sup>2</sup>Command only.**Table 6-7 Scope Capture Configuration Commands**

Command Keyword	Parameter	Description	Section
MEASure:SCOPE:BANDwidth	<i>Frequency</i>	Scope capture bandwidth.	6.8.7.1
MEASure:SCOPE:TIMEbase	<i>Time</i>	Capture time interval.	6.8.7.2
MEASure:SCOPE:TRIGger:VLEVel	<i>Voltage</i>	Voltage level for a V (voltage) type trigger.	6.8.7.3
MEASure:SCOPE:TRIGger:ALEVel	<i>Amps</i>	Current level for an A (current) type trigger.	6.8.7.4
MEASure:SCOPE:TRIGger:STEP	<i>#</i>	Step number for a step type trigger.	6.8.7.5
MEASure:SCOPE:TRIGger:POSition	<i>%</i>	Trigger position in the sample block.	6.8.7.6
MEASure:SCOPE:TRIGger:MODE	<i>MANual</i> <i>A</i> <i>B</i> <i>ON</i> <i>OFF</i> <i>STePA</i> <i>STePB</i> <i>VRISING</i> <i>VFALLING</i> <i>ARISING</i> <i>AFALLING</i>	Scope trigger.	6.8.7.7

**Table 6-8 Scope Capture Operation Commands**

Command Keyword	Parameter	Description	Section
MEASure:SCOPE:RUN <sup>2</sup>	<i>Stop</i> <i>Single</i> <i>Continuous</i>	Starts or stops scope data capture.	6.8.8.1
MEASure:SCOPE:STATus? <sup>1</sup>	-	Returns the present status of scope view capture as a NR1 as follows – 0: Scope view capture is stopped (no data has been collected) 1: Scope view capture is stopped (data has been collected) 2: Single scope view capture is in progress (no data has been collected) 3: Single scope view capture has completed (data has been collected) 4: Continuous scope view capture is in progress (no data has been collected) 5: Continuous scope view capture is in progress (data has been collected)	6.8.8.2
MEASure:SCOPE:DATA? <sup>1</sup>	-	Fetches the most recent scope data capture.	6.8.8.3

<sup>1</sup>Query only.<sup>2</sup>Command only.**Table 6-9 Measurement Control Commands**

Command Keyword	Parameter	Description	Section
MEASure:HISTory:STANdard:RUN	<i>0</i> <i>Off</i> <i>Stop</i> <i>1</i> <i>On</i> <i>Run</i>	Stops or starts the standard history data store.	6.8.9.1
MEASure:COMMand	<i>Period</i>	Executes a commanded measurement.	6.8.9.2

These commands only support the command form.

**Table 6-10 Measurement Query Commands**

Command Keyword	Parameter	Description	Section
MEASure:REALtime?	-	Queries the realtime measurements.	6.8.10.1
MEASure:REALtime:VOLTage?	-	Queries the real-time voltage measurement.	6.8.10.2
MEASure:REALtime:CURRent?	-	Queries the real-time current measurement.	6.8.10.3
MEASure:REALtime:POWer?	-	Queries the real-time power measurement.	6.8.10.4
MEASure:REALtime:CONDuctance?	-	Queries the real-time conductance measurement.	6.8.10.5
MEASure:REALtime:RESistance?	-	Queries the real-time resistance measurement.	6.8.10.6
MEASure:SYNC:PULSe?	A/B	Queries synchronous pulse measurements.	6.8.10.7
MEASure:SYNC:STEP?	A/B	Queries synchronous step measurements.	6.8.10.8
MEASure:OCP?	A/B	Queries the last OCP test results.	6.8.10.9
MEASure:OPP?	A/B	Queries the last OPP test results.	6.8.10.10
MEASure:BATTery?	-	Queries the battery test results.	6.8.10.11
MEASure:EFFiciency?	-	Queries the efficiency measurements.	6.8.10.12
MEASure:EFFiciency:INPut?	-	Queries the efficiency input power value.	6.8.10.13
MEASure:EFFiciency:OUTput?	-	Queries the efficiency output power value.	6.8.10.14
MEASure:EFFiciency:EFFiciency?	-	Queries the efficiency result.	6.8.10.15
MEASure:COMMand?	-	Queries the commanded measurement results.	6.8.10.16
MEASure:HISTory:STANdard:RUN?	-	Queries the run state of the standard history data store.	6.8.10.17
MEASure:HISTory:LOADing:RUN?	-	Queries the run state of the loading history data store.	6.8.10.18
MEASure:HISTory:STANdard:SPAN?	-	Queries the length of time covered by the standard history data store in seconds.	6.8.10.19
MEASure:HISTory:STANdard:STARt?	-	Responds with the date and time the standard history started.	6.8.10.20
MEASure:HISTory:STANdard:END?	-	Responds with the date and time the standard history ended.	6.8.10.21
MEASure:HISTory:LOADing:SPAN?	-	Queries the length of time covered by the loading history data store in seconds.	6.8.10.22
MEASure:HISTory:LOADing:STARt?	-	Responds with the date and time the loading history started.	6.8.10.23
MEASure:HISTory:LOADing:END?	-	Responds with the date and time the loading history ended.	6.8.10.24
MEASure:HISTory:STANdard:DATA?	<i>N,Start,End,Data</i>	Queries the standard history data store.	6.8.10.25
MEASure:HISTory:LOADing:DATA?	<i>N,Start,End,Data</i>	Queries the loading history data store.	6.8.10.26

All these commands support only the query form.

**Table 6-11 Device Configuration Commands**

Command Keyword	Parameter	Description	Section
TRIGger:SOURce	<i>MANual</i> <i>BUTTON</i> <i>EXTernal</i> <i>COMMand</i>	Configures the load trigger.	6.8.11.1
ROUTE:TERMinals	<i>Front</i> <i>Rear</i>	Selects front or back terminals.	6.8.11.2
SENSe:VOLTage	<i>EXTernal</i> <i>INTernal</i>	Selects internal or external voltage sense.	6.8.11.3
DIO:PORT1:MODE	<i>INPut</i> <i>OUTput</i> <i>INOut</i>	Configures the mode of DIO connection #1.	0
DIO:PORT1:STATe	<i>0</i> <i>LOW</i> <i>1</i> <i>HIGH</i>	Configures the output state of DIO connection #1.	6.8.11.5
DIO:PORT1:LEVEl?¹	-	Queries the level on DIO connection #1.	6.8.11.6
DIO:PORT2:MODE	<i>INPut</i> <i>OUTput</i> <i>INOut</i>	Configures the mode of DIO connection #2.	6.8.11.7
DIO:PORT2:STATe	<i>0</i> <i>LOW</i> <i>1</i> <i>HIGH</i>	Configures the output state of DIO connection #2.	6.8.11.8
DIO:PORT2:LEVEl?¹	-	Queries the level on DIO connection #2.	6.8.11.9
SYSTem:DATE	<i>y,m,d</i>	System date.	0
SYSTem:TIME	<i>h,m,s</i>	System time.	6.8.11.11
SYSTem:IDENtify	<i>Boolean</i>	Control the system identify indicator.	6.8.11.12

¹Query only.

---

## 6.8 Command Details

---

### 6.8.1 IEEE Mandated Commands

#### 6.8.1.1 \*CLS

Clear status command. The error/event queue will be cleared, pending operation complete operations will be canceled, and clears the following registers:

- STB
- SRE
- ESR
- ERR

#### 6.8.1.2 \*ESR?

Standard **Event Status Register** query. The contents of the **Event Status Register** will be output as a decimal value.

#### 6.8.1.3 \*STB?

Standard **Read Status Byte** query. The contents of the **Status Byte Register** will be output as a decimal value, it will report 4 if at least one entry is present in the error/event queue; otherwise, it will report 0.

#### 6.8.1.4 \*SRE

See IEEE 488.2 11.3.2.4 for details.

#### 6.8.1.5 \*ESE

See IEEE 488.2 11.5.1.3 for details.

#### 6.8.1.6 \*RST

Reset the DL to a known state. The following actions are taken:

- Settings affecting the DC load function will be reset to the factory default state.
- Any active scope capture will be halted.
- If the load is active, it will be turned off.

#### 6.8.1.7 \*IDN?

Query the unique device identification string. The response is four string values separated by commas:

Manufacturer,Model,Serial-Number,Firmware-Version

Note the firmware version is composed of two components, one for the interface processor and one for the load processor.

#### 6.8.1.8 \*OPC

The command form executes an operation complete request, the DL will set the OPC bit in the Standard Event Status Register when all pending selected device operations have been finished. For details on what selects the pending operations refer section 6.9.

#### **6.8.1.9 \*OPC?**

The query form places an ASCII character “1” into the device’s Output Queue when all pending selected device operations have been finished. For details on what selects the pending operations refer section 6.9.

#### **6.8.1.10 \*WAI**

Wait-to-continue command. The DL will not execute any further commands or queries until all pending operations have completed.

#### **6.8.1.11 \*RCL**

Restore test settings from profile store N, N being a number in the range 0 to 8. The 0 (zero) value refers to the power on settings, 1 to 8 refer to previously saved profiles. If selected profile has not been previously saved a **Data out of range** error is placed in the error/event queue.

#### **6.8.1.12 \*SAV**

Save test settings into store N, N being a number in the range 0 to 8. The 0 (zero) value refers to the power on settings, 1 to 8 refer to storage locations for the test and measurement settings.

#### **6.8.1.13 \*SDS**

Save the present test settings for use as the power-on configuration. This has the same effect as when command “\*SAV 0” is used.

#### **6.8.1.14 \*TST**

Executes the self-test query. The DC Load sub-system elements are verified and zeroed. The instrument configuration is not changed. Before executing the command it is vital that nothing be connected to the inputs. The scope of the tests is listed below.

- Fans
- Temperature sensors
- Voltage zeros
- Voltage scaling
- Current zeros
- Loading DACs
- Current linearity
- Loading MOSFETs
- NV Memory

If the self-test completes successfully the response is **\*TST complete**; if an element fails a test the response will identify the failure and provide details that may help correct the issue.

## **6.8.2 System Remote/Local access commands**

### **6.8.2.1 SYSTem:LOCK:REQuest?**

This event shall only be implemented as a query. It will attain the lock on this device and returns 1. The lock persists until the connection is closed or the RELease command is executed.

### **6.8.2.2 SYSTem:LOCK:RELease**

Releases the user lock.

### **6.8.2.3 SYSTem:LOCK:OWNer?**

Reports the present state of the lock. The response is one of two strings:

- **REMOte**
- **LOCal**

## **6.8.3 System Event/Error query commands**

### **6.8.3.1 STATus:PRESet**

See SCPI 1999.0.

### **6.8.3.2 SYSTem:ERRor:ALL?**

See SCPI 1999.0.

### **6.8.3.3 SYSTem:ERRor:CODE:ALL?**

See SCPI 1999.0.

### **6.8.3.4 SYSTem:ERRor[:NEXT]?**

See SCPI 1999.0.

### **6.8.3.5 SYSTem:ERRor:CODE[:NEXT]?**

See SCPI 1999.0.

### **6.8.3.6 SYSTem:ERRor:COUNT?**

See SCPI 1999.0.

### **6.8.3.7 SYSTem:ERRor:ENABLE**

See SCPI 1999.0.

### **6.8.3.8 SYSTem:ERRor:ENABLE:ADD**

See SCPI 1999.0.

#### 6.8.3.9 **SYSTem:ERRor:ENABLE:DELeTe**

See SCPI 1999.0.

#### 6.8.3.10 **SYSTem:ERRor:ENABLE[:LIST]**

See SCPI 1999.0.

#### 6.8.3.11 **SYSTem:VERSion**

See SCPI 1999.0.

### 6.8.4 **Source loading common configuration commands**

All common configuration commands support both the query and command forms. Where not explicitly discussed the query form responds with the present setting.

#### 6.8.4.1 **SOURce:METhod**

The query form of the command produces a response identifying the present loading method. The following table lists the possible strings:

Response	Description
DIS	Loading is disabled
A	Load at level A.
B	Load at level B.
PULS	Pulse between levels A and B, the rate is a function of the individual level configurations.
INT	Pulse-Interleave between levels A and B, the rate is a function of the individual level configurations.

The command form sets the loading method. The method can be changed while the load is active, excepting that when the method is disabled the load is turned off. Note that some combinations of modes disallow some methods, for example: pulsing of OCP or OPP is not allowed; interleaving of two basic levels is not allowed. See the configuration hints in section 6.8.5.44 for examples on how to configure a complex loading function. The DL will accept the following parameter keywords for the corresponding methods:

Method	Parameters
Disabled	dis disabled
Level A	A



Level B	B
Pulse	puls pulse
Interleave	intr interleave

If the parameter is not one of the previously allowed values an **Illegal parameter value** is placed in the error/event queue.

If the method change would select a level either of **OCP**, **OPP**, or **Short** when battery testing is enabled the setting is disallowed, and a **Settings conflict** error is placed in the error/event queue.

If Pulse or Interleave is specified but the underlying level modes conflict with the setting is disallowed, and a **Settings conflict** error is placed in the error/event queue.

Note that the option to disable the loading method is included for symmetry with the front panel but is an illogical setting.

#### 6.8.4.2 SOURce:COMMon:RHF

The command form sets the Rhf factor and can take the form of a keyword or user setting in the range 0.02 to 100.0. The allowed keywords are:

- fast
- medium-fast
- medium
- medium-slow
- slow

The query form response is one of the setting keywords or a numeric value in ohms.

#### 6.8.4.3 SOURce:COMMon:TRIP:ENABLE

This command configures the option user trip voltage trip option. The parameter is a Boolean setting. See the next command for the associated value.

#### 6.8.4.4 SOURce:COMMon:TRIP:LEVel

This command configures the user voltage trip level. If the load processor measures a voltage at or above this level the load will trip and if active will deactivate. The level is only applied if the option is enabled by the previous command.

#### 6.8.4.5 SOURce:COMMon:PLIMit:ENABLE

This command configures the option to enable or disable application of the pulse limit count. The parameter is a Boolean setting.

#### 6.8.4.6 SOURce:COMMon:PLIMit:COUNT

This command configures the pulse limit count. When enabled the count limits the number of times the load switches between the level modes. The command accepts a count in the range 1 to 99999999.

#### **6.8.4.7 SOURce:COMMon:BATTery:ENABle**

This command configures the option to enable or disable battery testing. The parameter is a Boolean setting. When enabling battery testing if the present loading method and level select either of **OCP**, **OPP**, or **Short** the setting is disallowed, and a **Settings conflict** error is placed in the error/event queue.

#### **6.8.4.8 SOURce:COMMon:BATTery:VOLTage**

When battery testing is enabled, this command configures the voltage level that will automatically cause loading to be deactivated if the measurement falls below the setting. The parameter is an NR3 in the range 0.0 to 9999999.9.

#### **6.8.4.9 SOURce:COMMon:BATTery:TLIMit**

When battery testing is enabled, this command configures the test time limit in seconds. The time period starts from the moment the load is activated. If the time limit is reached the load will be deactivated. The parameter is an NR1 in the range 1 to 999999.

#### **6.8.4.10 SOURce:COMMon:SOFTstart:ENABle**

This command configures the option to enable or disable the soft-start option. When enabled soft-start slows the increases in the load as a function of time. The parameter is a Boolean setting.

#### **6.8.4.11 SOURce:COMMon:SOFTstart:COVerge**

This command configures or queries the setting for when to apply soft-start. It takes one of the following keywords:

- on
- always

#### **6.8.4.12 SOURce:COMMon:SOFTstart:RAMp**

This is the time period over which changes in the loading factors will be slowed down. It allows values in the range 0.000010 to 10000 seconds.

#### **6.8.4.13 SOURce:COMMon:SOFTstart:LEVel**

This is the configuration setting for the voltage level that when exceeded triggers soft-start.

#### **6.8.4.14 SOURce:COMMon:LIMit:RISing:FILTer:ENABle**

This command configures the option to enable or disable the rising current time filter. The keyword is a Boolean setting.

#### **6.8.4.15 SOURce:COMMon:LIMit:RISing:FILTer:TIME**

This command configures the rising current time filter. It allows values in the range 0.0000001 to 3.5 seconds.

#### **6.8.4.16 SOURce:COMMon:LIMit:RISing:CURRent:ENABle**

This command configures the option to enable or disable the rising current filter. The parameter is a Boolean setting.

#### **6.8.4.17 SOURce:COMMon:LIMit:RISing:CURRent:LIMit**

This is the rising current limit setting in terms of amps/time in units of amps/ $\mu$ s. It accepts values in the range 0.000001 to 20.0 A/ $\mu$ s.

#### **6.8.4.18 SOURce:COMMon:LIMit:FALLing:FILTer:ENABle**

This command configures the option to enable or disable the falling current time filter. The parameter is a Boolean setting.

#### **6.8.4.19 SOURce:COMMon:LIMit:FALLing:FILTer:TIME**

This command configures the falling current time filter. It allows values in the range 0.0000001 to 3.5 seconds.

#### **6.8.4.20 SOURce:COMMon:LIMit:FALLing:CURRent:ENABle**

This command configures the option to enable or disable the rising current filter. The parameter is a Boolean setting.

#### **6.8.4.21 SOURce:COMMon:LIMit:FALLing:CURRent:LIMit**

This is the falling current limit setting in terms of amps/time in units of amps/ $\mu$ s. It accepts values in the range 0.000001 to 20.0 A/ $\mu$ s.

### **6.8.5 Source loading level A and B configuration commands**

In the following sections the keyword LVLA can be replaced with LVLB. For example:

#### ***source:lvlb:mode BASIC***

Configures the loading mode for level B to basic.

All level configuration commands support both the query and command forms. Where not explicitly discussed the query form responds with the present setting.

#### **6.8.5.1 SOURce:LVLA:MODE**

This command queries or configures the level's loading mode. It takes one of the following keywords:

<b>Keyword</b>	<b>Selected Mode</b>
Basic	Static loading of dynamic CR/CC/CP levels.
Short	Static loading at maximum conductance.
Open	Static loading at minimum conductance.

Keyword	Selected Mode
Table	Loading a dynamic current level corresponding to the input voltage.
Arbitrary	Executes a series of basic loading levels as a function of time.
Sweep	Performs a sequence of steps by incrementing the current or power load over a number of predefined steps using a linear or logarithmic curve.
OCP	Performs a sequence of steps by incrementing the current load over a specified time period, halting the sequence if the measured voltage falls below a specified cutoff level.
OPP	Performs a sequence of steps by incrementing the power load over a specified time period, halting the sequence if the measured voltage falls below a specified cutoff level.

If battery testing is enabled **OCP**, **OPP**, and **Short** are disallowed, and a **Settings conflict** error is placed in the error/event queue.

If the method is pulsed or interleaved a change to OCP or OPP is disallowed, and a **Settings conflict** error is placed in the error/event queue.

#### 6.8.5.2 SOURce:LVLA:BASic:CV:VALue

Basic level CV voltage: the voltage below which the loading is always 0.

#### 6.8.5.3 SOURce:LVLA:BASic:CV:ENABLE

Enables voltage limiting. The parameter is a Boolean setting. If an attempt to turn off the CV enable results in no limits the command is discarded, and a **Settings conflict** error is placed in the error/event queue.

#### 6.8.5.4 SOURce:LVLA:BASic:CC:VALue

Basic level CC current: sets the loading current.

#### 6.8.5.5 SOURce:LVLA:BASic:CC:ENABLE

Enables current limiting. The parameter is a Boolean setting. If an attempt to turn off the CC enable results in no limits the command is discarded, and a **Settings conflict** error is placed in the error/event queue.

#### 6.8.5.6 SOURce:LVLA:BASic:CW:VALue

Basic level CW watts: sets the loading power level.

#### 6.8.5.7 SOURce:LVLA:BASic:CW:ENABLE

Enables power limiting. The parameter is a Boolean setting. If an attempt to turn off the CW enable results in no limits the command is discarded, and a **Settings conflict** error is placed in the error/event queue.

#### 6.8.5.8 SOURce:LVLA:BASic:CR:VALue

Basic level CR resistance or conductance: sets the maximum conductance when loading. The value can have a units suffix using the keyword ohms or siemens, the default is ohms. Examples:

Command	Action
SOURce:LVLA:BASic:CR:VALue 3.234e+3	Sets the parameter to 3234 ohms.
SOURce:LVLA:BASic:CR:VALue 1.23 ohms	Sets the parameter to 1.23 ohms.
SOURce:LVLA:BASic:CR:VALue 4 ohms	Sets the parameter to 4 ohms.
SOURce:LVLA:BASic:CR:VALue 871siemens	Sets the parameter to 871 Siemens.

#### 6.8.5.9 SOURce:LVLA:BASic:CR:ENABLE

Enables resistance limiting. The parameter is a Boolean setting. If an attempt to turn off the CR enable results in no limits the command is discarded, and a **Settings conflict** error is placed in the error/event queue.

#### 6.8.5.10 SOURce:LVLA:BASic:HOLD

The amount of time this level is held when pulsing, this is a command time period parameter, this does not apply when the level is continuous.

#### 6.8.5.11 SOURce:LVLA:OPEN:HOLD

The amount of time this level is held when pulsing, this is a command time period parameter, this does not apply when the level is continuous.

#### 6.8.5.12 SOURce:LVLA:SHORT:HOLD

The amount of time this level is held when pulsing, this is a command time period parameter, this does not apply when the level is continuous.

#### 6.8.5.13 SOURce:LVLA:TABLE:VMIN

The voltage below which the loading is always 0. If the table has at least one entry the VMIN setting must be less than the voltage setting in the first entry.

#### 6.8.5.14 SOURce:LVLA:TABLE:PMAx

The maximum loading power level.

#### 6.8.5.15 SOURce:LVLA:TABLE:HOLD

The amount of time this level is held when pulsing, this is a command time period parameter, this does not apply when the level is continuous.

#### 6.8.5.16 SOURce:LVLA:TABLE:POINTs:FIRSt

Clears the table and sets the first point. It takes two parameters: voltage, current. The voltage setting must be greater than VMIN.

#### 6.8.5.17 SOURce:LVLA:TABLE:POINTs:APND

Appends an entry to the table, it takes two parameters: voltage, current. The voltage setting must be greater than the voltage setting in the last entry.

#### 6.8.5.18 SOURce:LVLA:TABLE:POINTs:NUM?

Responds with the number of entries in the table.

#### 6.8.5.19 SOURce:LVLA:TABLE:POINTs?

Responds with the list of entries; each entry is formatted as a comma separated pair of NR3 values representing voltage and current delimited by semicolon.

#### 6.8.5.20 SOURce:LVLA:ARBitrary:FIRSt

Clears the list and sets the first entry. It takes between two to six parameters depending on the required step behavior. The first required parameter is a mode keyword:

Mode	Description
BASIC	Selects a basic operation step with one to four limiting regions.
OPEN	Selects a step that loads at maximum conductance.
SHORT	Selects a step that loads at minimum conductance.

If the keyword is invalid an **Illegal parameter value** error is placed in the error/event queue.

The second required parameter is the hold time is a command period parameter.

If a basic mode is selected there must be at least one limiting region specified using the syntax RR=num where

**RR** is one of

CC for constant current

CW for constant power

CV for constant voltage

CR for constant resistance – see section `SOURce:LVLA:BASic:CR:VALue` 6.8.5.8 for instructions on setting the value in terms of conductance or resistance

and **num** sets the limiting level. When the mode is configured in basic mode at least one limit must be specified; in the event a limit is not configured the command is discarded, and a **Data questionable** error is placed in the error/event queue.

#### 6.8.5.21 `SOURce:LVLA:ARBitrary:APND`

Appends an entry to the list, it takes parameters in a form identical to the `FIRSt` command in section 6.8.5.20 above. For example, to configure an arbitrary level with a mix of step types the following series of commands could be issued:

```
source:lvla:arbitrary:first basic,0.1,CC=0.100
source:lvla:arbitrary:apnd short,0.02
source:lvla:arbitrary:apnd basic,0.4,CW=0.500
source:lvla:arbitrary:apnd basic,3,CV=7.5
source:lvla:arbitrary:apnd open,1.5
source:lvla:arbitrary:apnd basic,2.5,CC=0.100,CW=0.500
```

The resulting loading would operate as follows:

Step #	Time period	Loading
1	100 milliseconds	Constant current at 100 milliamps
2	20 milliseconds	Short
3	400 ms	Constant power at 0.5 watts
4	3 seconds	Constant voltage at 7.5 volts
5	1.5 seconds	Open
6	2.5 seconds	CC/CW

#### 6.8.5.22 `SOURce:LVLA:ARBitrary:NUM?`

Responds with the number of arbitrary entries.

#### 6.8.5.23 `SOURce:LVLA:ARBitrary?`



Responds with the list of entries; each entry is formatted as a comma separated set of two to six of values representing the mode, hold time, and limiting values separated by commas; each entry is delimited by a semicolon. The CR setting will be reported in Siemens or Ohms depending on the user preference setting for the desired units.

#### 6.8.5.24 `SOURce:LVLA:SWEEp:MODE`

Configures queries the sweep mode; as a command the parameter is one of **current** or **power**, when queried the response is one of **current** or **power**.

**6.8.5.25 SOURce:LVLA:SWEep:TYPE**

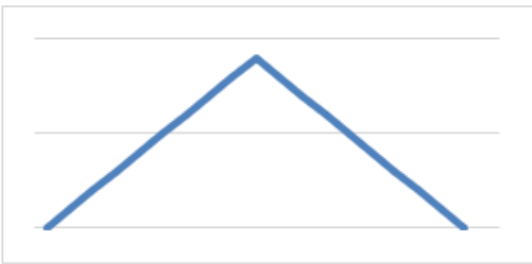
Selects the shape of the loading curve and if the ramp should be reversed. It takes one of four keywords:

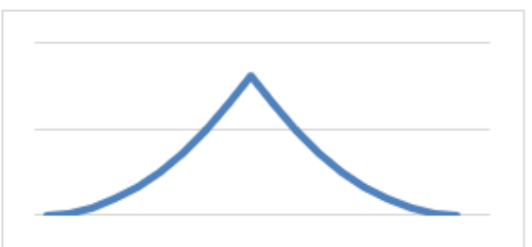
Type	Shape
Linear	
Linear-Dual	
Log	
Log-Dual	

**6.8.5.26 SOURce:LVLA:SWEep:START**

Starting value, cannot be 0 for a logarithmic sweep.

**6.8.5.27 SOURce:LVLA:SWEep:END**

Ending value, cannot be 0 for a logarithmic sweep.



**6.8.5.28 SOURce:LVLA:SWEep:STEPs**

The number of steps in the sweep.

**6.8.5.29 SOURce:LVLA:SWEep:TIME**

The amount of time at each step specified as a command time period parameter.

**6.8.5.30 SOURce:LVLA:OCP:VTRip**

Voltage trip level, the voltage below which the sweep is terminated.

**6.8.5.31 SOURce:LVLA:OCP:MIN**

Minimum current threshold that must be exceeded for the test to pass.

**6.8.5.32 SOURce:LVLA:OCP:START**

The sweep starting value in amps, must be less than the ending value.

**6.8.5.33 SOURce:LVLA:OCP:END**

The sweep ending value in amps, must be greater than the starting value.

**6.8.5.34 SOURce:LVLA:OCP:PERiod**

The time period for the sweep.

**6.8.5.35 SOURce:LVLA:OCP:RECovery**

The recovery time after completing each sweep until starting the next one, it can be zero.

**6.8.5.36 SOURce:LVLA:OCP:MODE**

Selects if the OCP sweep runs once or continuously. It accepts the following keywords for controlling the mode:

Keyword	Action
SINGLE	Specifies the test should run once.
CONTinuous	Specifies the test runs continuously respecting the recovery time period.

**6.8.5.37 SOURce:LVLA:OPP:VTRip**

Voltage trip level, the voltage below which the sweep is terminated.

**6.8.5.38 SOURce:LVLA:OPP:MIN**

Minimum power threshold that must be exceeded for the test to pass.

**6.8.5.39 SOURce:LVLA:OPP:START**

The sweep starting value in watts.

#### 6.8.5.40 SOURce:LVLA:OPP:END

The sweep ending value in watts, must be greater than the starting value.

#### 6.8.5.41 SOURce:LVLA:OPP:PERiod

The time period for the sweep.

#### 6.8.5.42 SOURce:LVLA:OPP:RECovery

The recovery time after completing each sweep until starting the next one, it can be zero.

#### 6.8.5.43 SOURce:LVLA:OPP:MODE

Selects if the OPP sweep runs once or continuously. It accepts the following keywords for controlling the mode:

Keyword	Action
SINGLE	Specifies the test should run once.
CONTInuous	Specifies the test runs continuously respecting the recovery time period.

#### 6.8.5.44 Loading configuration hints

Some of the level modes disallow the Pulse or Interleave methods, for example: pulsing of OCP or OPP is not allowed; interleaving of two basic levels is not allowed. To properly set a complex loading method/level configuration use the following examples as a guide.

##### Pulsing between two basic levels

```
source:method a
source:lvla:mode basic
source:lvlb:mode basic
source:method pulse
```

##### Interleaving basic with sweep

```
source:method a
source:lvla:mode sweep
source:lvlb:mode basic
source:method interleave
```

##### OCP/OPP

```
source:method a
source:lvla:mode ocp
```

## 6.8.6 Loading operation commands

### 6.8.6.1 SOURce:STATe

Turns loading on, off, or arms loading for a trigger. It accepts the following keywords for controlling the state:

Keyword	Action
off	Turns loading off.
armed	Arms loading for a trigger, the trigger setting is discussed in section 6.8.11.1.
on	Turns loading on, ignores any trigger setting.

In the query form the response carries the present loading state as a string:

- Off
- Armed
- On
- Tripped

If an attempt to turn the load on when battery mode is enabled, and the voltage is below the battery test threshold an **Execution Error** will be placed in the error/event queue and the load will not be activated.

### 6.8.6.2 SOURce:ALARm?

Reports the loading alarm status bits as an NR1. The following table lists the bit definitions.

Bit #	Description
0	Excessive voltage on the inputs - tripped.
1	High temperature - system tripped.
2	High temperature warning.

### 6.8.6.3 SOURce:NEXT

Continue a pulsed, interleaved, or stepped loading. The command requires a time interval that specifies a measurement period before the level or step is changed. A value of 0 specifies that no measurement is made, and the loading state is advanced; the measurement can be queried using a measurement command - see 6.8.10.7. The maximum time interval is 10000 seconds.

### 6.8.6.4 SOURce:TRIGger

Trigger the load to activate that was previously configured for a command trigger and was armed. If the configuration is not set for a command trigger a **Settings conflict** error is placed in the error/event queue. If the state was not previously armed a **Trigger ignored** error is placed in the error event queue.

### 6.8.6.5 ABORt

Disable loading and halt scope capture.

## 6.8.7 Scope Capture configuration commands

### 6.8.7.1 MEASure:SCOPE:BANDwidth

Configures the capture bandwidth setting in units of Hertz and must be in the range 1000.0 to 1000000.0.

### 6.8.7.2 MEASure:SCOPE:TIMEbase

Configures the capture time interval un units of seconds and must be in the range 0.000010 to 10000.0.

### 6.8.7.3 MEASure:SCOPE:TRIGger:VLEVEL

Configures the voltage level used when the VRISING or VFALLING trigger mode is selected.

### 6.8.7.4 MEASure:SCOPE:TRIGger:ALEVEL

Configures the current level used when the ARISING or AFALLING trigger mode is selected.

### 6.8.7.5 MEASure:SCOPE:TRIGger:STEP

Configures the step number used when the STEPA or STEPB trigger mode is selected.

### 6.8.7.6 MEASure:SCOPE:TRIGger:POSITION

Specifies the trigger position as a percentage.

### 6.8.7.7 MEASure:SCOPE:TRIGger:MODE

Configures when the scope data will be captured. The keyword options are listed below.

Keyword	Description
NONE	Capture is always made as soon as possible, asynchronously with the signal or loading.
A	A change to level A.
B	A change to level B.
ON	A change to the loading ON state.
OFF	A change from the loading ON state.
STEPA	A change to a specific step in level A.
STEPB	A change to a specific step in level B.
VRISING	The V samples changing from below to above the trigger level (i.e., a rising edge trigger).
VFALLING	The V samples changing from above to below the trigger level (i.e., a falling edge trigger).
ARISING	The A samples changing from below to above the trigger level (i.e., a rising edge trigger).
AFALLING	The A samples changing from above to below the trigger level (i.e., a

	falling edge trigger).
--	------------------------

## 6.8.8 Scope Capture control and data commands

### 6.8.8.1 MEASure:SCOPE:RUN

Starts or stops scope data capture. The command requires a keyword from the following table:

Keyword	Description
SING	Initiates a single scope data capture.
CONT	Initiates continuous scope data capture.
STOP	Halts data capture.

### 6.8.8.2 MEASure:SCOPE:STATus?

Responds with the present status of scope capture as a NR1 listed below:

Value	Description
0	Scope view capture is stopped (no data has been collected).
1	Scope view capture is stopped (data has been collected).
2	Single scope view capture is in progress (no data has been collected).
3	Single scope view capture has completed (data has been collected).
4	Continuous scope view capture is in progress (no data has been collected).
5	Continuous scope view capture is in progress (data has been collected).

### 6.8.8.3 MEASure:SCOPE:DATA?

Responds with the most recent scope data capture; note that if a capture has not completed there will be no response and **Data corrupt or stale** error will be placed in the error/event queue. If data is available, the reply will be a series of comma separated pairs of voltage/current measurements delimited by the semicolon character.

Note that this query is synchronized with MEASure:SCOPE:RUN and can be utilized in conjunction with **\*OPC?**. The following sequence illustrates use of synchronization:

```
MEASure:SCOPE:RUN;*OPC?
MEASure:SCOPE:DATA?
```

## 6.8.9 Measurement control commands

### 6.8.9.1 MEASure:HISTory:STANdard:RUN

This command starts or stops data collection in the standard history store. It accepts a single keyword listed below:

Keyword	Action
0	Stops data collection.

Off	Stops data collection.
Stop	Stops data collection.
1	Starts data collection, present data will be cleared.
On	Starts data collection, present data will be cleared.
Run	Starts data collection, present data will be cleared.

### 6.8.9.2 MEASure:COMMand

This command executes a series of measurements over a specified period. When the measurements are complete, they can be queried. The single parameter is a time interval in the range 0.000010 to 10000 seconds.

## 6.8.10 Measurement query commands

### 6.8.10.1 MEASure:REALtime?

Queries the realtime measurements. The response is five NR3 values separated by commas. If for some reason one of the realtime measurements are not available, the value will be reported as 9.91E37. The five values are as follows:

- Voltage in Volts
- Current in Amperes
- Power in Watts
- Conductance in Siemens
- Resistance in Ohms

### 6.8.10.2 MEASure:REALtime:VOLTage?

Queries the real-time voltage measurement. The response is a single NR3 value. If for some reason the voltage measurement is not available, the value will be reported as 9.91E37.

### 6.8.10.3 MEASure:REALtime:CURREnt?

Queries the real-time current measurement. The response is a single NR3 value. If for some reason the voltage measurement is not available, the value will be reported as 9.91E37.

### 6.8.10.4 MEASure:REALtime:POWer?

Queries the real-time power measurement. The response is a single NR3 value. If for some reason the power measurement is not available, the value will be reported as 9.91E37.

### 6.8.10.5 MEASure:REALtime:CONDuctance?

Queries the real-time conductance measurement. The response is a single NR3 value. If for some reason the conductance measurement is not available, the value will be reported as 9.91E37.

#### 6.8.10.6 MEASure:REALtime:RESistance?

Queries the real-time resistance measurement. The response is a single NR3 value. If for some reason the resistance measurement is not available, the value will be reported as 9.91E37.

#### 6.8.10.7 MEASure:SYNC:PULSe?

Queries synchronous pulse measurements. The command requires a single keyword selecting level A or level B:

- A
- B

This measurement is only available when the following conditions are met:

- The loading is in the ON state.
- And, Level A (or B) is configured for either “open”, “short”, “basic”, or “table”.
- And, the level selection mode is either “pulsed” or “interleave”.
- And the hold time exceeds the specified minimum for synchronous measurements.

If the present load configuration settings do not provide for synchronous pulse measurements, there is no response and a **Settings conflict** error is placed in the error/event queue. If measurements are allowed the response is five NR3 values separated by commas. Measurements may not be available at the time the command was executed; in that case the values will be reported as 9.91E37. The five values are as follows:

- Voltage in Volts
- Current in Amperes
- Power in Watts
- Conductance in Siemens
- Resistance in Ohms

Note that this query is synchronized with SOURce:STATe and can be utilized in conjunction with \*OPC?.

The following sequence illustrates use of synchronization:

```
SOURce:STATe on;*OPC?  
MEASure:SYNC:PULSe a?
```

#### 6.8.10.8 MEASure:SYNC:STEP?

Queries synchronous step measurements. The command requires a single keyword selecting level A or level B:

- A
- B



This measurement is only available when the following conditions are met:

- The loading is in the ON state.
- And, Level A (or B) is configured for either “arbitrary” or “sweep” or “OCP” or “OPP”.
- And the step intervals exceed the specified minimum for step measurements.

If the present load configuration settings do not provide for synchronous step measurements, there is no response and a **Settings conflict** error is placed in the error/event queue.

The response is pairs of comma separated voltage/current measurement delimited by the semicolon character; each pair corresponds to a level step change. Measurements may not be available for a given step so the values will be reported as 9.91E37.

Note that if step data is not available there will be no response and **Data corrupt or stale** error will be placed in the error/event queue.

Note that this query is synchronized with SOURce:STATe and can be utilized in conjunction with \*OPC?. The following sequence illustrates use of synchronization:

```
SOURce:STATe on; *OPC?
MEASure:SYNC:STEP? a
```

#### 6.8.10.9 MEASure:OCP?

Queries the latest OCP test results. The command requires a single keyword selecting level A or level B:

- A
- B

Note that the present loading configuration does not need to select OCP testing as this query is for data measured in the past. The response is three comma separated values in the form **NR1,NR2,NR3**. The values are respectively:

Value	Description
#1	Set to 1 if data was available, otherwise 0 (zero).
#2	Set to 1 if the OCP sweep completed properly, in that the voltage dropped below the dropout limit; set to 0 if the voltage was not limited over the test sequence.
#2	The highest current achieved while not DUT limited.

If data was not available, the sweep status will carry 'X' and the highest current will be reported as 9.91E37.

#### 6.8.10.10 MEASure:OPP?

Queries the latest OPP test results. The command requires a single keyword selecting level A or level B:

- A
- B

Note that the present loading configuration does not need to select OPP testing as this query is for data measured in the past. The response is three comma separated values in the form **NR1,NR1,NR3**. The values are respectively:

Value	Description
#1	Set to 1 if data was available, otherwise 0 (zero).
#2	Set to 1 if the OPP sweep completed properly, in that the voltage dropped below the dropout limit; set to 0 if the voltage was not limited over the test sequence.
#2	The highest power achieved while not DUT limited.

If data was not available, the sweep status will carry 'X' and the highest power will be reported as 9.91E37.

Note that these protection queries are synchronized with SOURce:STATe and can be utilized in conjunction with \*OPC?. The following sequence illustrates use of synchronization in OCP testing:

```
SOURce:STATe on;*OPC?
MEASure:OCP a?
```

#### 6.8.10.11 MEASure:BATTery?

Queries the battery test results. If the present load configuration is not enabled for battery testing there is no response and a **Settings conflict** error is placed in the error/event queue. This query can be submitted during the battery test or any time after the battery test has completed. The response is four comma separated values as an **NR1,NR3,NR3,NR3**. The values are respectively:

Value	Description										
#1	<p>The status of the battery result data:</p> <table border="1"> <tbody> <tr> <td>0</td> <td>No battery test results are available.</td> </tr> <tr> <td>1</td> <td>Partial battery test results are available, the test is still running.</td> </tr> <tr> <td>2</td> <td>Partial results are available but invalid because the load was shutdown manually before the battery test completed.</td> </tr> <tr> <td>3</td> <td>Partial results are available but invalid because the load was shut down when the battery time limit was reached.</td> </tr> <tr> <td>4</td> <td>The test has completed and final results are valid because the voltage limit was used to turn the load off.</td> </tr> </tbody> </table>	0	No battery test results are available.	1	Partial battery test results are available, the test is still running.	2	Partial results are available but invalid because the load was shutdown manually before the battery test completed.	3	Partial results are available but invalid because the load was shut down when the battery time limit was reached.	4	The test has completed and final results are valid because the voltage limit was used to turn the load off.
0	No battery test results are available.										
1	Partial battery test results are available, the test is still running.										
2	Partial results are available but invalid because the load was shutdown manually before the battery test completed.										
3	Partial results are available but invalid because the load was shut down when the battery time limit was reached.										
4	The test has completed and final results are valid because the voltage limit was used to turn the load off.										
#2	The measured accumulated amps.										
#3	The measured accumulated watts.										

Value	Description
#4	The test execution interval in seconds.

If the battery results are not available, the measurements and time interval will be reported as 0.

Note that this query is synchronized with `SOURce:STATe` and can be utilized in conjunction with `*OPC?`.

The following sequence illustrates use of synchronization:

```
SOURce:STATe on;*OPC?
MEASure:BATTery?
```

#### 6.8.10.12 MEASure:EFFiciency?

Queries the efficiency measurements. If efficiency measurement is not enabled a **Settings conflict** error is placed in the error/event queue. If efficiency is enabled the response is three NR3 values separated by commas. If for some reason one of the measurements are not available or is otherwise invalid, the value will be reported as 9.91E37. The three values are as follows:

- Input power in Watts
- Output power in Watts
- Efficiency as a percentage

#### 6.8.10.13 MEASure:EFFiciency:INPut?

Queries the input power value. The response is a single NR3 value. If for some reason the power measurement is not available, the value will be reported as 9.91E37.

#### 6.8.10.14 MEASure:EFFiciency:OUTput?

Queries the output power measurement. The response is a single NR3 value. If for some reason the power measurement is not available, the value will be reported as 9.91E37.

#### 6.8.10.15 MEASure:EFFiciency:EFFiciency?

Queries the efficiency result. The response is a single NR3 value. If for some reason the result is not available or is invalid, the value will be reported as 9.91E37.

#### 6.8.10.16 MEASure:COMMand?

Report the results of the last commanded measurement. The response is two NR3 values for voltage and current separated by a comma. If the measurement has not completed or commanded in the first place the values will be reported as 9.91E37.

Note that this query is synchronized with `MEASure:COMMand` and can be utilized in conjunction with `*OPC?`. The following sequence illustrates use of synchronization:

```
MEASure:COMMand 0.1;*OPC?
MEASure:COMMand?
```

#### 6.8.10.17 MEASure:HISTory:STANdard:RUN?

Queries the run state of the standard history data store. The response is an NR1: a value of 1 indicates the store is running, a value of 0 (zero) indicates the store has been stopped.

**6.8.10.18 MEASure:HISTory:LOADing:RUN?**

Queries the run state of the loading history data store. The response is an NR1: a value of 1 indicates the store is running (loading is active), a value of 0 (zero) indicates the store has been stopped (loading is inactive).

**6.8.10.19 MEASure:HISTory:STANdard:SPAN?**

Queries the length of time covered by the standard history data store in seconds. The response is an NR3 stating the time span encompassed by the standard history store.

**6.8.10.20 MEASure:HISTory:STANdard:STArT?**

Responds with the date and time the standard history started. The response is a string in the form:

**YYYY/MM/DD hh:mm:ss**

where

- YYYY Calendar year
- MM Calendar month
- DD Calendar day
- hh Hours (24 hour format)
- mm Minutes
- ss Seconds

**6.8.10.21 MEASure:HISTory:STANdard:END?**

Responds with the date and time the standard history ended – may be the present time if the standard history store is running. The response is a string in the form:

**YYYY/MM/DD hh:mm:ss**

where

- YYYY Calendar year
- MM Calendar month
- DD Calendar day
- hh Hours (24 hour format)
- mm Minutes
- ss Seconds

**6.8.10.22 MEASure:HISTory:LOADing:SPAN?**

Queries the length of time covered by the loading history data store in seconds. The response is an NR3 stating the time span encompassed by the loading history store.

**6.8.10.23 MEASure:HISTory:LOADing:START?**

Responds with the date and time the loading history started – this will also be the timestamp of when loading was activated. The response is a string in the form:

**YYYY/MM/DD hh:mm:ss**

where

- YYYY Calendar year
- MM Calendar month
- DD Calendar day
- hh Hours (24 hour format)
- mm Minutes
- ss Seconds

**6.8.10.24 MEASure:HISTory:LOADing:END?**

Responds with the date and time the loading history ended – may be the present time if the loading history store is running because loading is active. The response is a string in the form:

**YYYY/MM/DD hh:mm:ss**

where

- YYYY Calendar year
- MM Calendar month
- DD Calendar day
- hh Hours (24 hour format)
- mm Minutes
- ss Seconds

**6.8.10.25 MEASure:HISTory:STANdard:DATA?**

Queries the standard history data store. The command requires four parameters specifying the desired data span and set:

Parameter #	Value	Description
1 – NR1	<i>N</i>	The number of points to produce, must be a value in the range 10 to 5000.
2 – NR1	<i>Start</i>	Starting time in seconds relative to the time at which standard historical data collection was last started.
3 – NR1	<i>End</i>	Ending time in seconds relative to the time at which standard historical data collection was last started, must be greater than <i>Start</i> .
4 - Keyword	<i>Data</i>	Specifies the data to query: <ul style="list-style-type: none"> <li>• LV Loading voltage measurements.</li> <li>• LA Loading current measurements.</li> </ul>

		<ul style="list-style-type: none"> <li>• LW Loading power measurements.</li> <li>• LS Loading conductance measurements.</li> </ul>
--	--	--

The response is N triplets of comma separated values carrying the maximum, average, and minimum values over each result time span; each triplet is separated by the semicolon character.

#### 6.8.10.26 MEASure:HISTory:LOADing:DATA?

Queries the loading history data store. The command requires four parameters specifying the desired data span and set:

Parameter #	Value	Description
1 – NR1	<i>N</i>	The number of points to produce, must be a value in the range 10 to 5000.
2 – NR1	<i>Start</i>	Starting time in seconds relative to the time at which standard historical data collection was last started.
3 – NR1	<i>End</i>	Ending time in seconds relative to the time at which standard historical data collection was last started, must be greater than <i>Start</i> .
4 - Keyword	<i>Data</i>	Specifies the data to query: <ul style="list-style-type: none"> <li>• LV Loading voltage measurements.</li> <li>• LA Loading current measurements.</li> <li>• LW Loading power measurements.</li> <li>• LS Loading conductance measurements.</li> </ul>

The response is N triplets of comma separated values carrying the maximum, average, and minimum values over each result time span; ; each triplet is separated by the semicolon character.

### 6.8.11 Device configuration commands

#### 6.8.11.1 TRIGger:SOURce

Configures the load trigger. The command form requires a single keyword specifying the trigger source/type as listed in the following table:

Parameter	Function
NONE	No trigger is used, when the loading function is activated, it immediately goes into effect.
BUTTON	When activated the loading function is suspended until the “GO” button on the front panel is pressed.
EXTERNAL	When activated the loading function is suspended until the configured DIO settings are satisfied.
COMMAND	When activated the loading function is suspended until the SOURCe:TRIGger (see section 6.8.6.4) command is received.

#### 6.8.11.2 ROUTe:TERMinals

In the command form the connection terminals are selected by the single parameter listed below:

Keyword	Description
FRONT	Front terminals
REAR	Rear terminals

The query form responds with the present terminal selection.

#### 6.8.11.3 SENSE:VOLTage

In the command form this configures if the voltage sense is internal or external according to the parameter shown in the following table:

Keyword	Description
EXT	Voltage is sensed from the external connection.
EXTERNAL	Voltage is sensed from the external connection.
INT	Voltage is sensed from the internal path.
INTERNAL	Voltage is sensed from the internal path.

**6.8.11.4 DIO:PORT1:MODE**

In the command form this configures the mode on DIO connection #1 according to the parameter shown in the following table:

<b>Keyword</b>	<b>Description</b>
RAW-INPUT	The DIO is input only and does not affect system operation.
TOGGLE-LOAD	Toggles the load on and off, uses the level setting as a polarity for ON.
START-LOAD	Start loading when the input level matches the polarity configuration.
STOP-LOAD	Stop loading when the input level matches the polarity configuration.
STEP-LOAD	Steps the load when running a stepped or pulsed configuration.
TOGGLE-LOAD-LEVEL	Toggles between levels A and B, A corresponds to the polarity setting.
RAW-INOUT	The DIO is input/output at a user specified level.
RAW-OUTPUT	The DIO is output only at a user specified level.
LOADING	Asserts at the configured polarity when loading is active.
ECHO	Is a copy of the upstream DIO pin.
FAULT	Asserts at the configured polarity when there is a hardware fault.
PASS	Asserts at the configured polarity when loading has a pass condition.
FAIL	Asserts at the configured polarity when loading has a failure condition.

**6.8.11.5 DIO:PORT1:STATE**

In the command form this configures the output level on DIO connection #1 according to the parameter shown in the following table:

<b>Keyword</b>	<b>Description</b>
0	Sets the output low.
LOW	Sets the output low.
1	Sets the output high.
HIGH	Sets the output high.

**6.8.11.6 DIO:PORT1:LEVEL?**

Queries the level on DIO connection #1. The response is LOW or HIGH.



**6.8.11.7 DIO:PORT2:MODE**

In the command form this configures the mode on DIO connection #2, the acceptable modes are listed in section 6.8.11.4.

**6.8.11.8 DIO:PORT2:STATE**

In the command form this configures the output level on DIO connection #2, the acceptable state values are listed in section 6.8.11.5.

**6.8.11.9 DIO:PORT2:LEVEL?**

Queries the level on DIO connection #2. The response is LOW or HIGH.

**6.8.11.10      SYSTem:DATE**

The command form sets the system date, and it requires three NR1 values to respectively set the internal calendar date. The following table lists the acceptable range for each component:

Value	Minimum	Maximum
Year	2000	2099
Month	1	12
Day	1	Month specific

The query form responds with the calendar date in the form **yyyy,mm,dd**.

**6.8.11.11      SYSTem:TIME**

The command form sets the system time, and it requires three NR1 values to respectively set the internal clock. The following table lists the acceptable range for each component:

Value	Minimum	Maximum
Hour	0	23
Minute	0	59
Second	0	60

This command complies with SCPI 199.0 in that if the seconds value is rounded to 60 it shall be set to 0 and the minute value incremented. Any other carries shall be rippled. The query form responds with the calendar date in the form **hh,mm,ss**.

**6.8.11.12      SYSTem:IDENTify**

The command form sets the state of the system identify indicator, the parameter is a Boolean setting that if true turns the indicator on and if false turns the indicator off. The query form responds with the present state of the indicator.

## 6.9 Device Synchronization

Some commands initiate device activity that result in one or more measurements that complete after some period or in response to an event. Execution of the \*OPC command or query is sensitive to the context of the most recent command that is coupled to the delayed measurements.

The commands that set the context and the operation that must complete are listed in the following table.

Command	Condition	Query
MEASure:SCOPE:RUN	Capture completes.	MEASure:SCOPE:DATA?( <sup>2</sup> )
MEASure:COMMMand	Measurement complete.	MEASure:COMMMand?
SOURce:STATe on SOURce:TRIGger	Loading activates and a pulse has completed.	MEASure:SYNC:PULSE? ( <sup>1</sup> ) ( <sup>2</sup> )
SOURce:STATe on SOURce:TRIGger	Loading activates and a step sequence has completed.	MEASure:SYNC:STEP? ( <sup>1</sup> ) ( <sup>2</sup> )
SOURce:STATe on SOURce:TRIGger	Loading activates and the sweep has completed.	MEASure:OCP? ( <sup>1</sup> ) ( <sup>2</sup> )
SOURce:STATe on SOURce:TRIGger	Loading activates and the sweep has completed.	MEASure:OPP? ( <sup>1</sup> ) ( <sup>2</sup> )
SOURce:STATe on SOURce:TRIGger	Loading activates and at least one measurement interval has completed. Battery testing takes precedence over the other measurement modes for purposes of synchronization.	MEASure:BATTERY? ( <sup>1</sup> ) ( <sup>2</sup> )

<sup>(1)</sup>It is implicit that the loading configuration supports this measurement.

<sup>(2)</sup>Execution of repeated \*OPC? is allowed for continued measurements.

If the \*OPC command or query is executed without a past command available for context, for example immediately after \*RST, the condition is immediately met: the OPC bit in the ESR is immediately set or execution of \*OPC? will immediately respond with 1.

## 7 DIO Interface

Using the DL Series Input & Output (DIO) interface the user may perform any combination of the following –

- Control the instrument using a PLC type device, starting, stopping, selecting a test level, and determining the pass/fail status.
- Control the instrument using external start and/or stop switches.
- Abort a test sequence when a safety interlock is opened.
- Allow the instrument to illuminate external safety indicators.

### 7.1 DIO Connector and Pinout

The DIO connector is on the rear panel as illustrated below.

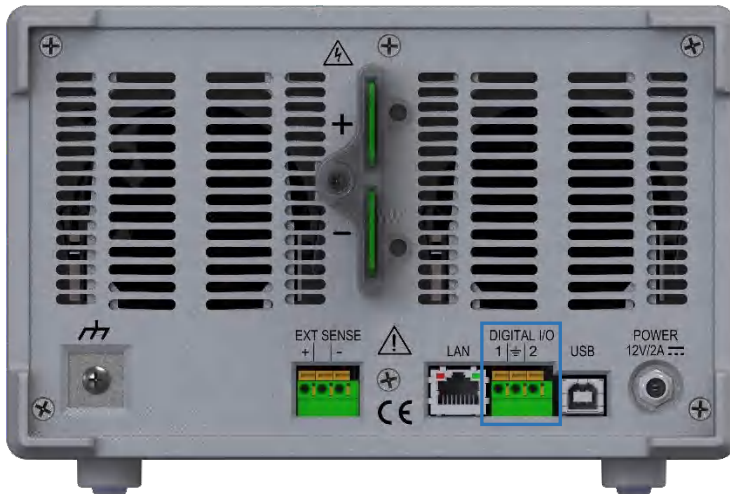

The connector uses wire entry sprung sockets. There are two input/output pins and a common ground.

Each pin is soft configured – front panel operations are shown in 5.3.2.6 and interface configuration is documented in sections 0 through 6.8.11.9.

The following functions are available, the pins are fully symmetrical:

Function	Direction	Description
Raw input	Input	The DIO is input only and does not affect system operation. The status is available for diagnosing integration issues.
Toggle load	Input	Toggles the load on and off, uses the level setting as the polarity for ON.
Start load	Input	Start loading when the input level matches the configured input polarity.
Stop load	Input	Stop loading when the input level matches the configured input polarity.

Step load	Input	Steps the load when running a stepped or pulsed configuration, the step is executed when the input level matches the configured polarity.
Toggle load level	Input	Toggles the loading method between levels A and B, A corresponds to the polarity setting.
Raw inout	Input/Output	The DIO is input/output at a user specified level, it is provided for integration testing.
Raw output	Output	The DIO is input/output at a user specified level, it is provided for integration testing.
Loading	Output	Asserts at the configured polarity when loading is active.
Echo	Output	Carries a copy of the alternate DIO pin, typically used to daisy chain a control signal.
Fault	Output	Asserts at the configured polarity when there is a hardware fault.
Pass	Output	Asserts at the configured level when loading has a pass condition, this only applies if the loading mode is OPC or OPP. Will stay asserted until a failure occurs, or a fresh loading sequence is started.
Fail	Output	Asserts at the configured level when loading has a failure condition, this only applies if the loading mode is OPC or OPP. Will stay asserted until a pass condition occurs, or a fresh loading sequence is started.

---

## 7.2 DIO Signal Characteristics

---

Each DIO signal is always both an output and an input, but the user could configure either (or both) capability to be ignored.

As an output, it is an open drain drive to 0V with a 10kOhm pull-up to 3.3V shared with the input side. Note that the pull-up has a diode in series with it, so becomes open if a voltage over 3.3V is applied. The output has a 1.2ohm maximum resistance to 0V when ON. This contains internal Zener protection at 14V (minimum). There is also a 0.1uF capacitance across the pin to 0V, present whether input or output. The output signal has a maximum current rating of 250mA maximum. As an output the signal can drive an external relay (for example) which must be externally powered by a voltage of up to 12V and contains clamping internally in the DL so an external diode is not needed.

As an input, detection of a low level is guaranteed for an external voltage below 0.7V, and a high level detection is guaranteed above 2.3V. Since there is an internal 10kOhm pull-up to 3.3V, the input can be driven from a contact closure to 0V, with a maximum contact resistance of 0.7V at 0.3mA (i.e., about

2kOhm). External signal levels can be directly applied, with a maximum of +14V and a minimum of -0.5V (each signal is diode clamped below 0V with a 50ohm resistance).

Since it is possible to use a signal as both an input and an open-drain output, this gives the capability of parallel connecting signals from several sources, the resultant signal only being actually detected as HI if all sources are driving it HI (i.e., any LO results in a LO).

## 8 WEB Browser Interface

The DL series operates a web server providing powerful tools for configuration, status, and control:

- ❖ Realtime clock setting
- ❖ LAN configuration settings
- ❖ Setting the username and password
- ❖ Instrument command
- ❖ Remote presence

The applications that can configure and control the unit are password protected. The username and password can be changed (see the configuration section below). The username and password will, however, be reset to the factory defaults if the front panel is used to execute the [LAN Reset](#) function.

The factory default username is **engineer**; the factory default password is **champion**.

To access the web interface, you must know the unit's mDNS name or IP address. To use the IP address, navigate to the System->About screen:



Type that IP address into your browser's location bar:

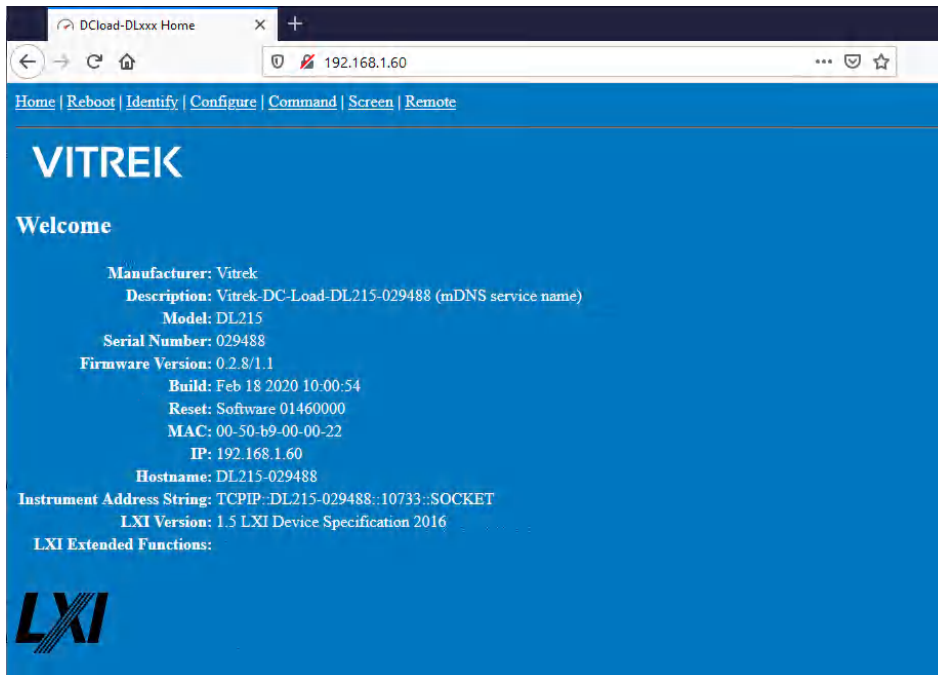

The DL presents the Home page – aka the Welcome page. You will see a menu bar at the top and basic device information.

Most of the menu bar links require the user to authenticate by entering a username and password. Many browsers will prompt to remember the credentials, it is the user's choice as to whether or not to save the credentials.

For example: presume you click on the **Configure** link, you will be prompted to enter a username and password.



How the user name and password are requested is dependent on the browser and browser version, the following example is from Firefox version 89.0.2.

This illustration uses the factory defaults:



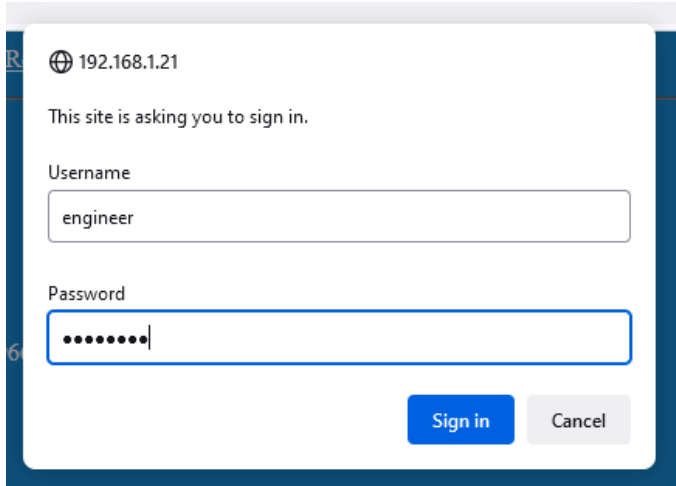

You will enter the credentials and click on OK.



If you use Cancel too many times the browser may stop trying to load the page and you will have to force a reload using control-F5.

Most browsers will automatically send the credentials in the background. If more than five minutes passes between challenges, you will have to type the credentials.

## Reboot

Use this command to cause the DL to restart as if the Power button was used to turn the instrument off then pressing the touch panel to turn it back on.

## Configuration Menu

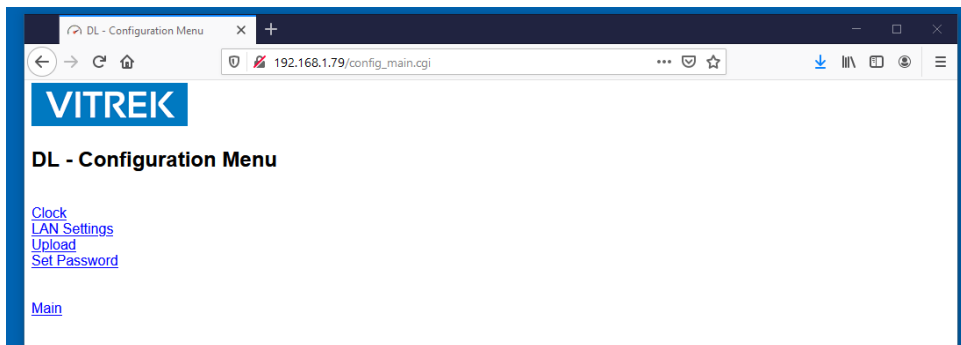

## Clock

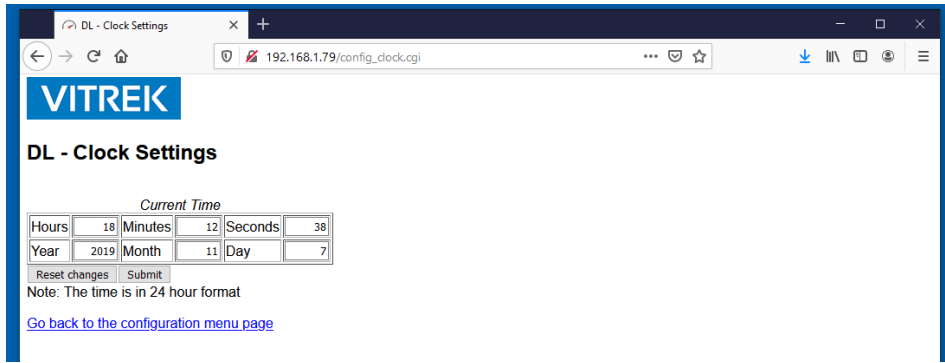

Use this page to set the DL's real time clock.

# LAN Settings

DL - LAN Settings

VITREK

DL - LAN Settings

Automatic
  Manual
  mDNS

Hostname: DL215-029488  
 Service: Vitrek-DC-Load-DL215-029488

Hostname and Service can only contain A-Z,a-z, 0-9, and dash.

DHCP  
 Auto-IP

You must have at least one automatic option selected

Submit

LAN Reset

[Go back to menu page](#)

LXI

The LAN interface can be configured to use an automatic or manual configuration. You must have at least one of DHCP or Auto-IP enabled. Check the **Manual** radio button to configure manually.

Press the **Submit** button to save the LAN configuration; note that your changes may affect the IP address you are presently using to access the unit. If you typed a blank hostname or service name, the factory default will be applied as necessary. The character set available for the names is restricted to those allowed for internet naming.

The **LAN Reset** button can be used to reset the network interface settings to the factory defaults excepting the host and service names. The web username and password will also be restored to the factory defaults.

When the **Submit** or **LAN Reset** buttons are pressed the settings are saved and the interface is configured, the web page will change to:

Applying Settings

If the address is static the page will redirect to the main configuration page after a few seconds. If the address is changed from manual to dynamic the page will show:

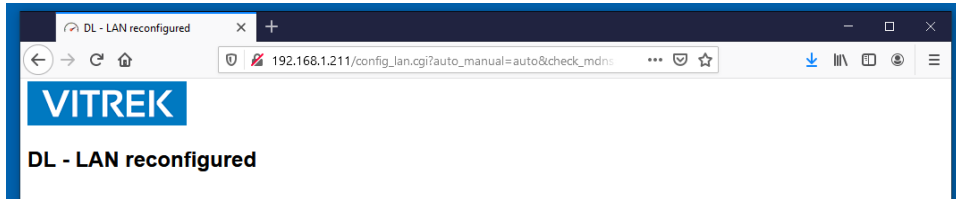

You will have to determine the new address from the unit's display and enter it into the location bar.

## Upload

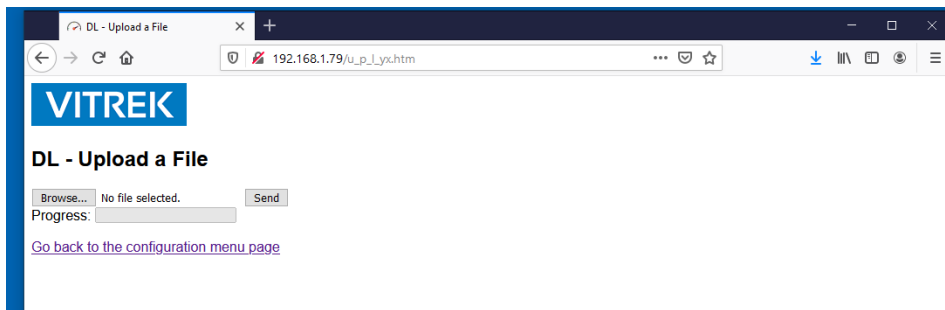

You can use this facility to install firmware updates or custom configuration files. You click on **Browse** to activate the native browser's file navigation mechanism to select the file, then click on **Send** to upload the file.

## Set Password

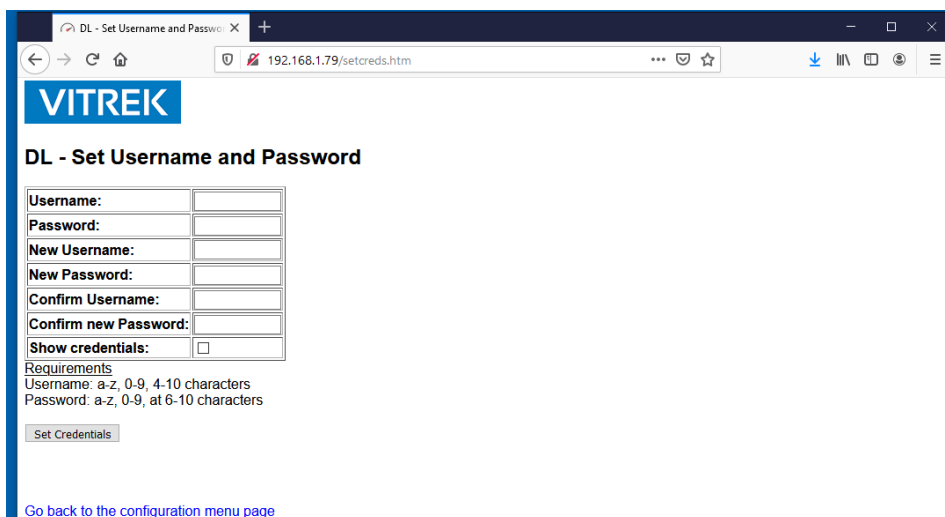

You can use this tool to change the access credentials. You will have to type the present username and password, the new username and new password twice, then click on **Set Credentials** to update the information in the DL.

# Identify

This link toggles the identity indicator visible on the front panel status bar. The browser will briefly display a status message showing if the indicator is now on or off:

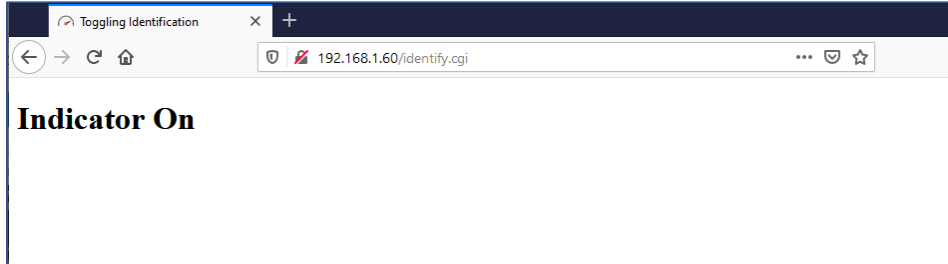

OR



On the DL the  logo found on the status bar will flash between its normal and a reddish color:



# Command

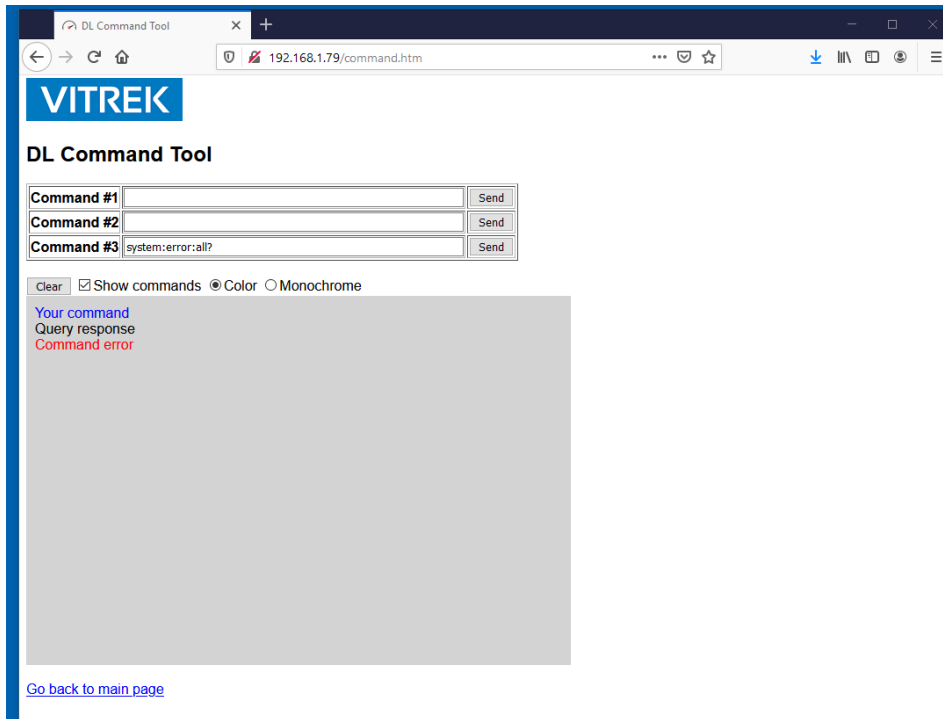

This applet allows interface commands to be issued to the unit, any command response is show below. When the page loads it shows the color coding that will help discriminate commands and responses. The user can use the radio buttons to select Color or Monochrome text in the history area. When Monochrome is selected the formatting looks like:

*Your  
command*  
**Query  
response**  
**Command  
error**

The “system:error:all?” command is placed into command #3 as a convenience.

The user should be familiar with the command set. When commands are issued the unit will apply a command lock on the front panel interface that will end in 60 seconds if no other commands are issued. As long as commands are being issued the lock timer is pushed out 60 seconds.

## Screen

This link shows a screen capture of the present contents of the front panel display. It is an 800x480 png image. You can use your browser functions to save the image if you wish.

## Remote

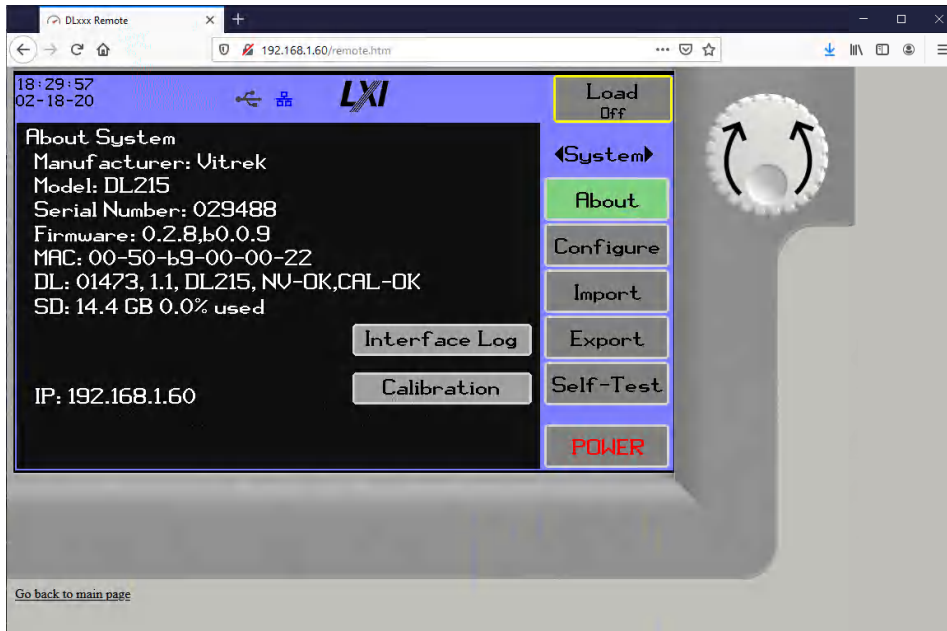

This applet allows full control over the unit as if the user is interacting with the front panel. The screen image is updated once per second, more often if the user is clicking on the virtual screen or manipulating the dial.

A mouse click on the screen image acts like a touch to the front panel. Click on the center of the dial to issue a button press, click on the left side of the dial to rotate clockwise, click on the right side of the dial to rotate counterclockwise.

## 9 Efficiency Measurement Integration

The DL series can be integrated with Vitrek's PA9xx series high performance power analyzer to acquire efficiency data surrounding the DUT. A typical setup would look like:

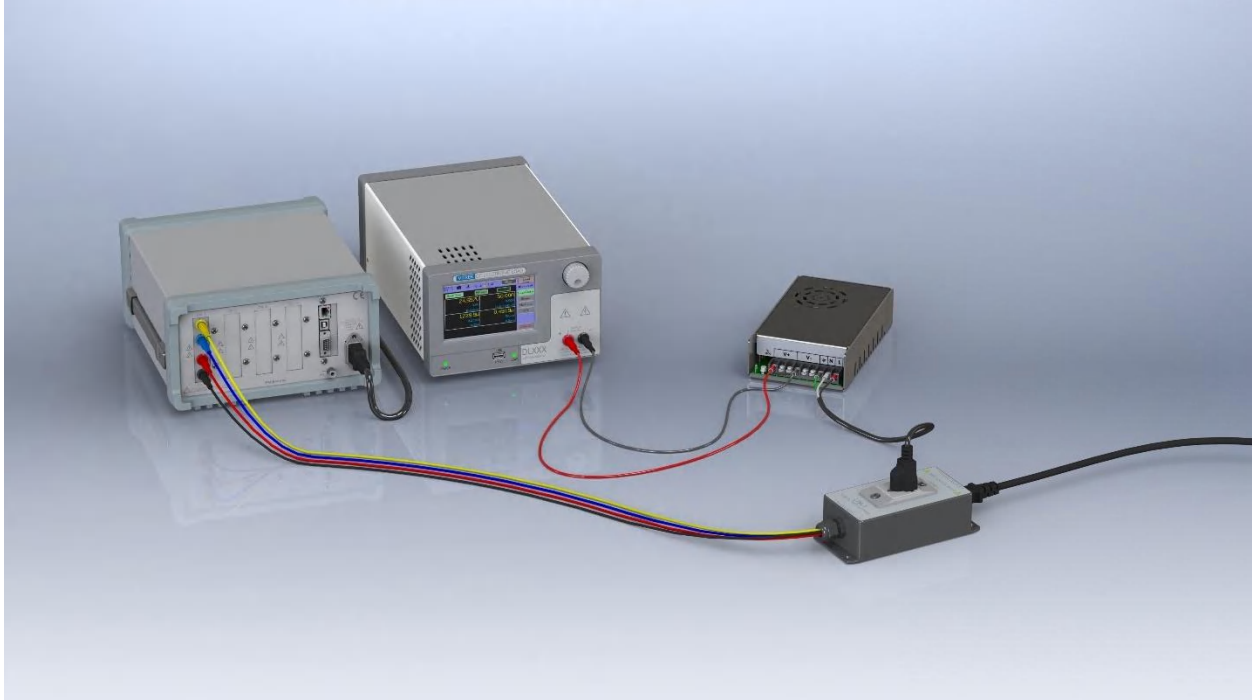

The instruments need to be networked to provide this functionality. The PA9xx provides a measurement of power input to the DUT – a DC power supply in this example. Efficiency is a computation of the ratio of DC loading power over the input power.

This section summarizes the settings on the PA9xx, see the user manual for full details, in particular section 21.2.

To configure the PA9xx as the source the power input to your DUT enable multi-unit operation using group 1. Make sure the measurement configuration for efficiency/loss is set for 'INPUT' as illustrated:

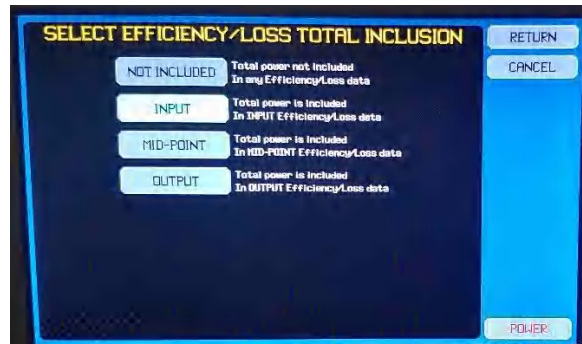
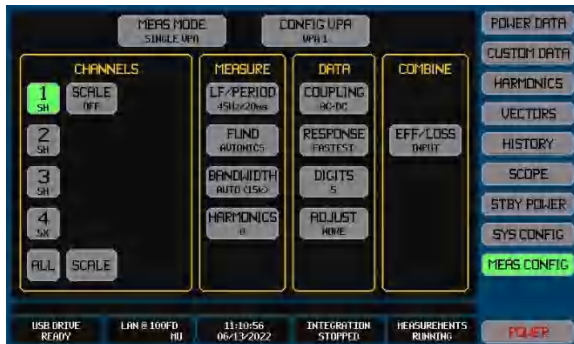



## 10 Troubleshooting

### 10.1 Calibration

All DL models ship from the factory fully calibrated. If for any reason the calibration data has been corrupted, when the DL is powered on it will show a Calibration Warning message:

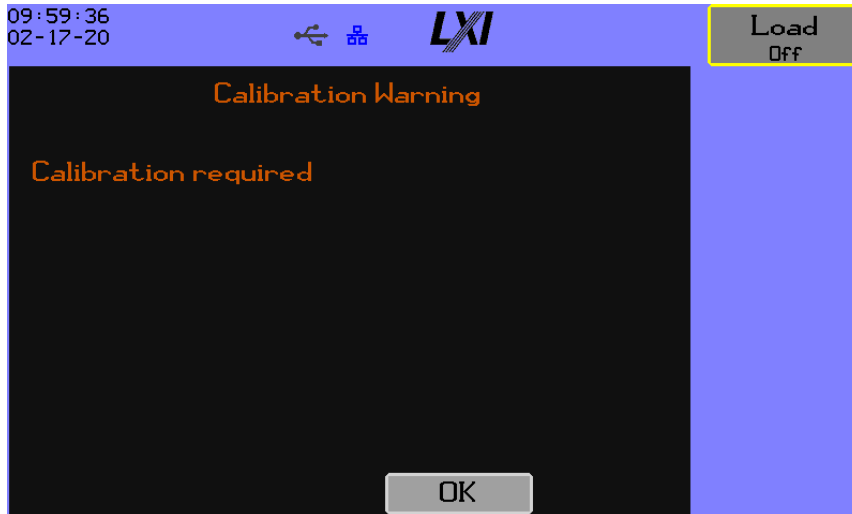

There are four calibration warning states:

- Calibration unavailable
- Calibration uninitialized
- Calibration needs Self-Test
- Calibration required (illustrated above)

External adjustment calibration is required. Contact Vitrek for assistance. The calibration status of the DL can be viewed on the System->About screen, the information is highlighted below:



The indicated information is shown in Orange when the calibration is invalid.

---

## 10.2 Critical Fault

---

A critical fault may occur if the loading circuitry is damaged by overheating, high voltages, component failure, or otherwise. The fault is illustrated below:



To recover remove all any connections to the input terminals and voltage sense connector; touch OK and navigate to System->Self-Test and press **Start** (see section 5.3.4) to run the self-test procedure. If the self-test does not successfully complete the unit must be serviced by an authorized technician.

---

## 10.3 Overvoltage

---

The DL has a model specific hard voltage limit and an optional user configurable limit that can be set to a limit below the hard limit. If the DL measures a voltage on the input terminals that approaches the either limit the status bar will show a warning message:



If the voltage exceeds either limit the load will trip off and a critical warning screen will appear:

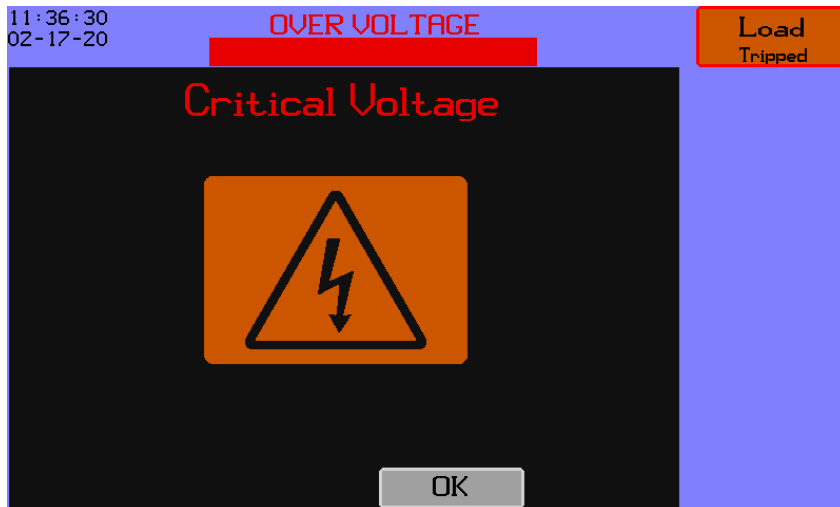

The user should immediately reduce the voltage if this can safely be performed. The user can touch the OK button to return to the previous display, but the load will not return to normal operation until the **Load Tripped** button is pressed and the critical voltage level is no longer applied. Note that the excessive voltage may have damaged the unit and the fault condition shown in Section 7.2 may occur.

#### 10.4 Over temperature

When loading at the limits of the unit's capabilities, when operating without sufficient ventilation around the unit, or operating in a warm environment the unit may report a temperature warning on the status line:



The user should correct the issue in a timely manner. If the unit's operating temperature is exceeded the load will trip off and an over temperature fault will show on the status bar:



The report will persist until the user touches the **Load Tripped** button, note the trip may not clear if the temperature has not fallen below the maximum operating temperature. The user should wait for the unit to cool before attempting to clear the trip again.

#### 10.5 Fan Fault

The unit continuously validates that the fans are operating properly. In the event one or more fans fail the status bar will show **FAN FAULT:**



The unit will operate with restricted limits on current and power until corrected. The user should investigate for any blockage of ventilation that could inhibit the fan's operation.

---

## 10.6 DC Load Limiting

---

If you detect circumstances when loading does not operate at the levels you specify, navigate to **Results->Numeric** and check for the symbols discussed in section 5.1.2.1 indicating that limiting has been applied to the loading level(s).

## A. LAN Presence

The DL series complies with LXI (LAN eXtensions for Instrumentation) Version 1.5 LXI Device Specification 2016. In addition, it has the extended functionality supporting the VXI-11 Discovery and Identification Extended Function. In combination with mDNS service discovery the IP address of the instrument can be easily ascertained without having to browse the local display.

### Addressing

Depending on the settings discussed in section 5.3.2.10 the LAN interface's configuration is dynamic, automatic, or manual. When the LAN status indicator  is blue then the DL is properly configured.

### Naming



The DL's factory name takes the form *MODEL-SN* where *MODEL* is the DL's model and *SN* is the serial number, for example DL215-020304. The factory service name is in the form Vitrek-DC-Load-MODEL-SN, for example: Vitrek-DC-Load-DL215-020304.

After the interface has an address, the DL will attempt to determine its name on the network. If the manual configuration has a DNS address or the addressing is dynamic the DL will use reverse DNS then forward DNS to validate the hostname; if the DNS server provided a hostname that matches the IP address, then the unit advertises that name on the welcome page.



The DL will still respond to mDNS lookups if the feature is enabled. It is recommended that mDNS remain enabled – it has been observed that some Windows configurations will not actually use DNS to lookup a name, instead relying on NBNS then mDNS. Contact your IT administrator to resolve these issues.

If the DNS query is not satisfied the DL will present the mDNS local name on the welcome page if the configured name did not conflict with another device on the network or the conflict could be resolved – see below.

In the event DNS lookup failed or mDNS was not enabled or could not be resolved the DL will show the IP address on the welcome screen.

#### mDNS Conflict Resolution

Conflicts with mDNS names and services are resolved during the probing phase. If the conflicts cannot be resolved the DL will not enable mDNS. The conflicts are resolved by appending a suffix in the form “-N” where the N is a number in the range 2 through 9.

To illustrate how the resolution occurs here is an example.

Presume a lab with two DL's deployed for testing and you want the name and service to relate to the work at hand. You intend to name the first as “lab-dl-ps” and the second “lab-dl-battery” but name

them both “lab-dl-ps”. You power up the first then the second, the second detects the naming conflict and adopts “lab-dl-ps-2” and until reconfigured will use that name. Service naming works in the same way.

## Services and Protocols

The DL utilizes and supports the following protocols.

- The DHCP Protocol (only if configured to use DHCP).
- The ARP protocol (only to ensure the uniqueness of its own IP address, and as necessary to confirm the presence of the computer which has a TCP/IP socket established to the DL, the DL does not arbitrarily generate ARP requests).
- The ICMP reception of a ‘ping’ and the transmission of its response (it cannot generate a ‘ping’).
- mDNS if enabled in the LAN configuration. It will respond to type A queries containing its name with the .local suffix; it will respond with its service name to PTR queries for \_lxi.\_tcp.local or \_http.\_tcp.local.
- The DL will respond to VXI-11 Discovery requests with the command TCP/IP port number – 10733.
- The DL has a web server on TCP/IP port 80 and provides pages for status, command, and configuration.
- Transfer of ASCII data from the DL to a computer using the TCP/IP protocol to which it has a TCP/IP socket established only when and as directed by that computer (only a single socket is allowed by the DL). Data transmitted from the DL can only be configuration information, measurement results, and measurement status information. These are all non-broadcast datagrams, so in a well-designed network these datagrams will not be transmitted beyond the connection between the computer and the DL.

The DL does not support:

- Communications with a computer with which it does not have a TCP/IP socket established (which can only be established by the computer, not by the DL).
- Reception of any broadcast requests other than DHCP (only if enabled), ARP, mDNS (only if enabled), and VXI-11 discovery; all other received broadcasts are silently ignored.
- Transmission of any broadcast packets other than DHCP (only if enabled), mDNS (only if enabled), and ARP (only as required to ensure the uniqueness of its own IP address).
- Network management protocols such as SNMP, SSDP, LLDP, SDP, CDP etc., or routing protocols such as RIP etc.
- Any ‘file system’, NETBIOS, or similar protocols.
- POP, SMTP, IMAP, or similar protocols which might establish a connection to another computer.

## B. Installing Virtual COM Ports on Windows Variants

The necessary Windows inf files are provided on the CD shipped with the DL. If necessary, you can visit <https://vitrek.com/dl-series-electronic-dc-load/> to download the necessary files.

### Windows 7

When the USB cable is connected between the DL and PC the PC may show a pop-up indicating that driver software is being installed. Let it complete the process and state the driver was not installed or cancel it. Open Windows Device Manager and look for the **DLxxx Virtual ComPort**:

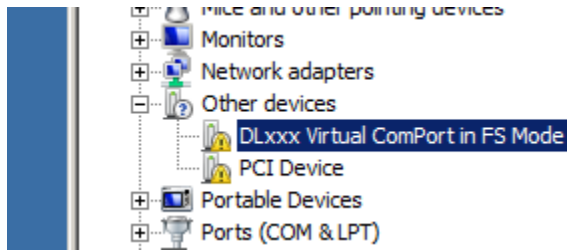

Right click on the ComPort and select Update Driver. On the dialog that opens select Browse my computer for driver software:

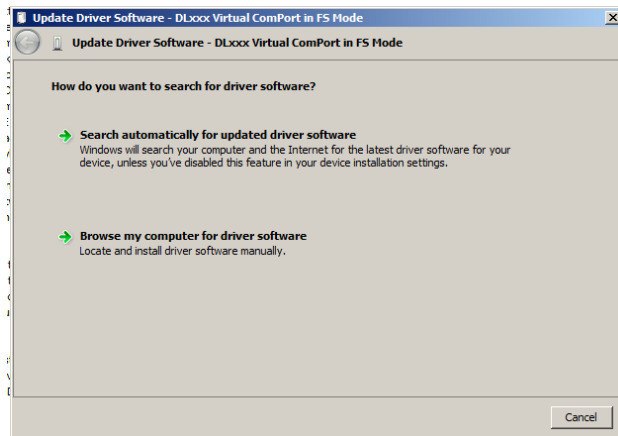

Browse to `\vcp\win7` on the CD (or where you downloaded and extracted the driver files) and click on Next. A warning dialog appears:

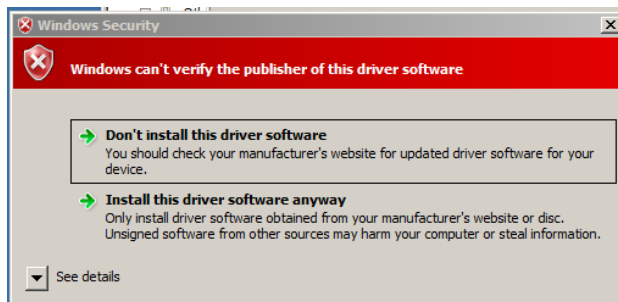

Select **Install this driver software anyway**, you are done.

## Windows Vista

Upon connection of the USB cable a dialog will appear:



Select **Locate and install driver software**. On the next dialog select **Don't search online**:

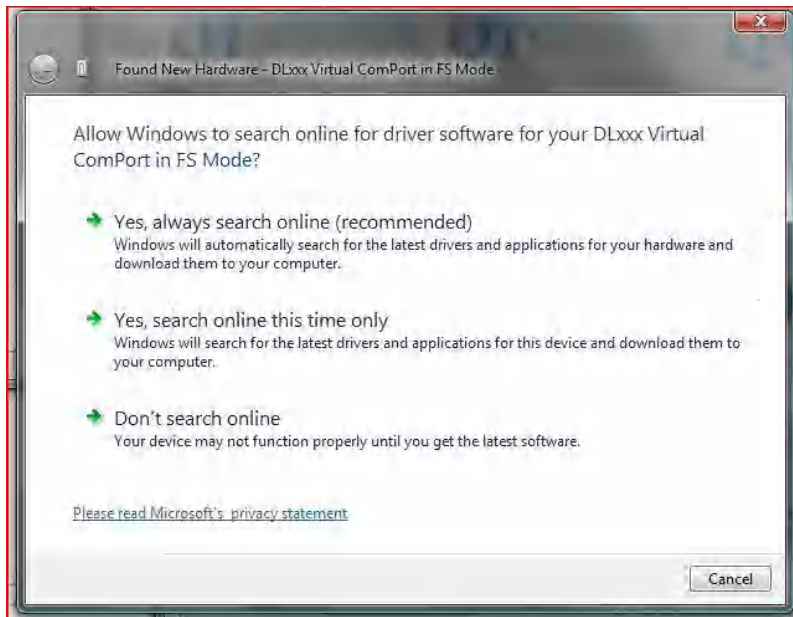



Then select **Show me other options:**

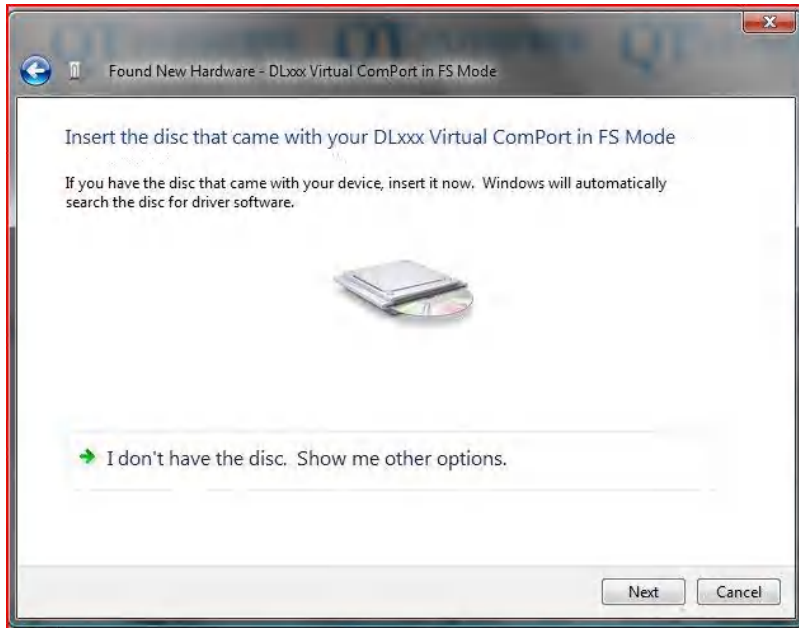

Then **Browse my computer for driver software:**

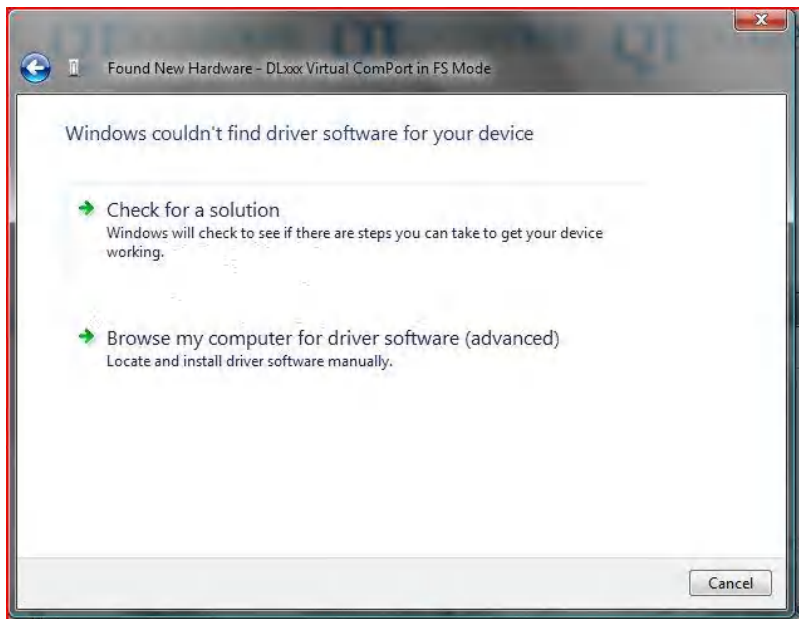

Browse to `\vcp\win7` on the CD (or where you downloaded and extracted the driver files), click on **Open**. A warning dialog is displayed:



Click on **Install this driver software anyway**. You are done. Find the port using **Open Windows Device Manager** and look for the **DLxxx Virtual ComPort**.

## Windows 2000 and XP

Upon connection of the USB cable the driver wizard dialog will appear:



Click on **Next**:



Check **Search for a suitable driver for my device**, click on **Next**:

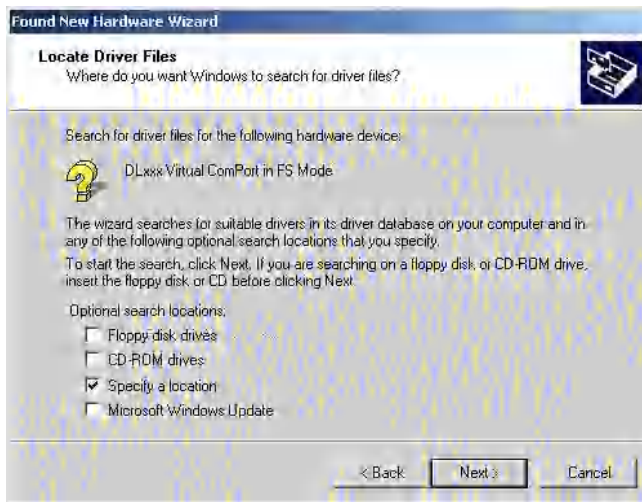

Check **Specify a location**, click on **Next**. Browse to **\vcp\xp** on the CD (or where you downloaded and extracted the driver files) and select **dl\_series\_vcp\_xp.inf**, click on **Open**, windows shows:

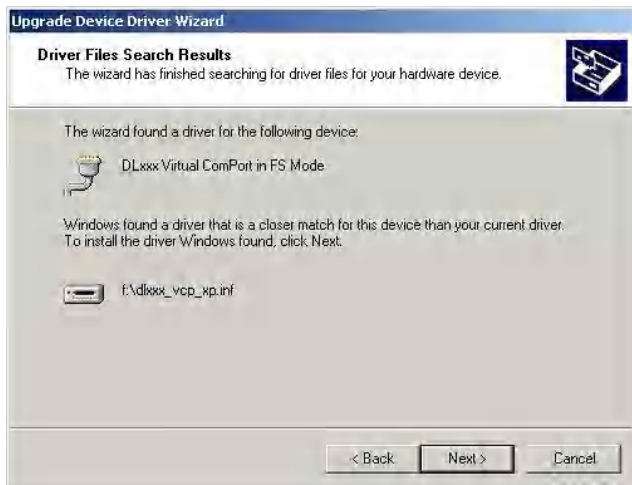

Click on **Next**, a warning dialog will appear:



Click on Yes. Installation will complete. Find the port using Open Windows Device Manager and look for the **DLxxx Virtual ComPort**.

## Windows 10

On Windows 10 the COM port will not carry an obvious name to identify the interface to the DL. If you run Windows Device Manager, you may already have multiple COM ports:

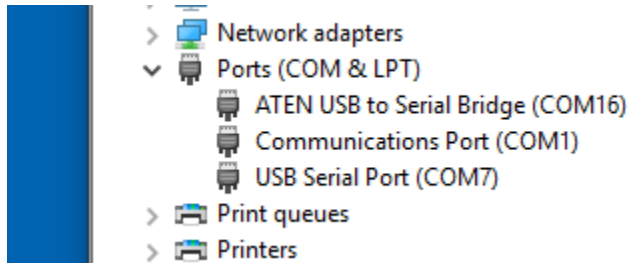

To isolate which port is the DL look at the Ports list without the DL attached, then plug in the USB cable and look again:

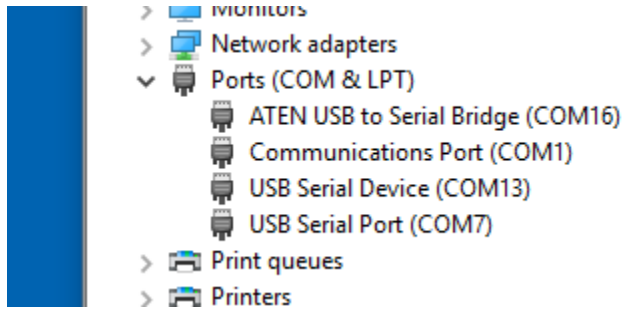

It will be observed that COM13 is the DL.