

Source-Sinks

# SOURCE-SINK QL SERIES

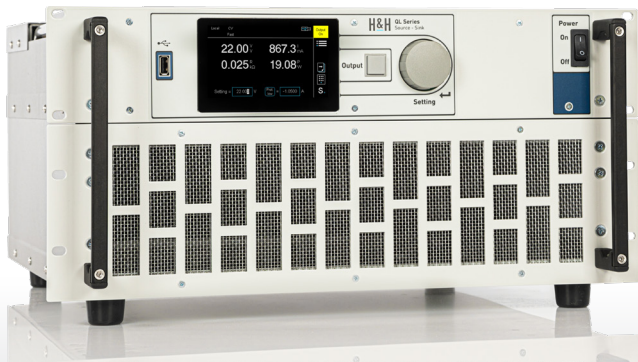

- 2- or 4-quadrant models
- DC source-sink
- Additionally AC source with 4-quadrant models
- Basic operating modes CC, CV, CP, CR
- Combined operating modes CC+CV, CV+CC
- Adjustable upper and lower protections for V and I
- Adjustable internal resistance in CC and CV mode
- Functions for test of energy storage devices
- Internal resistance measurement
- List function with synchronized DAQ
- Rectangular, PWM and modulation function

## SERIE QL – Brief Profile

QL series devices are sources and sinks or, respectively, power supply and electronic load in one device. They are used in testing a wide variety of energy storage devices, as well as other DUTs such as motors, chargers or coils.

The standard portfolio offers 2- or 4-quadrant devices up to 3,600 W. In addition to DC operation, 4-quadrant devices also provide the function of an AC source.

## Interfaces

- RS-232
- USB
- LAN
- GPIB
- CAN
- Analog
- Analog isolated

● Standard    ○ Option    — not available

## Operating Modes in DC and AC mode

In addition to constant voltage (CV) and constant current (CC) operation, the QL source-sinks also operate in constant resistance (CR) and constant power (CP) mode. In addition, one upper and one lower limit value each can be set for voltage and current. Thus the combined operating modes CC+CV, CV+CC, CP+CV and CR+CV are realized. 4-quadrant devices can also be used as AC sources.

## Source-Sink Mode

Depending on the setting of the output variable and the properties of the connected DUT, the device automatically decides whether it operates as a source or as a sink.

## 2-/4-Quadrant Models

Devices for 2-quadrant operation can supply current or consume reverse current when the output voltage is positive. To ensure that the desired function is provided at settings close to 0 V and longer connection lines, the 2-quadrant devices already operate at negative voltages from -1 V. In principle, 2-quadrant devices are also 4-quadrant devices, but with a reduced negative voltage. 4-quadrant devices can set negative values of the same magnitude as positive values.

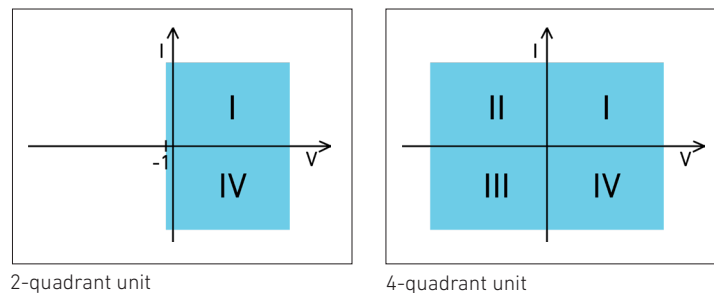

## I/O Port

Standard or isolated (option QL06)

Analog signals  
in realtime!

The standard I/O port provides analog and digital signals for external control.

### Outputs:

- Analog voltage monitor signal  
-10 ... 0 ... 10 V
- Analog current monitor signal  
-10 ... 0 ... 10 V
- Output activation state
- Status output for high protection level
- Status output for low protection level
- Trigger output

### Inputs:

- Analog setting of I, V, P, R  
with -5 ... 0 ... 5 V or with -10 ... 0 ... 10 V
- Analog setting for upper and lower voltage or current protection with -10 ... 0 ... 10 V
- Output activation
- Operating mode selection CC - CV
- Control speed selection
- Remote shut-down
- Readable digital input (by SCPI command)
- Trigger input

As an option, there is a galvanically isolated version for the I/O port (option QL06).

## Factory Calibration Certificate (FCC-QLxx)

2 x for free

We supply a free Factory Calibration Certificate (FCC) with the devices. The calibration process is subject to supervision in accordance with DIN EN ISO 9001. This calibration certificate documents the traceability to national standards to illustrate the physical device in accordance with the International System of Units (SI). Within the 2-year warranty period, we will calibrate a second time free of charge if the respective device will have been registered:

<https://www.hoecherl-hackl.com/service/device-registration>

For use under laboratory conditions, H&H recommends a calibration interval of 2 years. This is an empirical value that can be used as a guide for the first period of use. Depending on the intended use, service life, relevance of the application and ambient conditions, the operator should adjust this interval accordingly.

## Mechanics

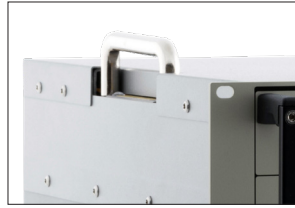

Retractable handle

The QL series is designed in robust 19" technology and can be used as a desktop device or installed in a rack. No additional installation kits are required for 19" installation.

From 5 height units, there are retractable heavy-weight handles on the top of the device.

## Functions

### Discharge Function

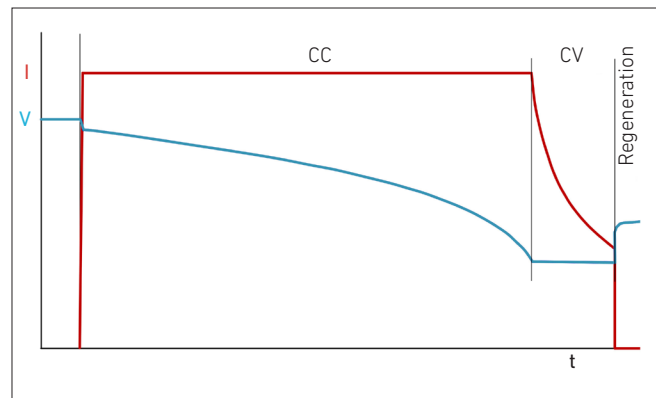

IUa discharge with follow-up time

The discharge function tests energy storage devices such as batteries, accumulators, ultracaps, electrolytic capacitors, etc. by discharging them in CC, CP or CR mode. The discharge function can be combined with the list function so that defined discharge profiles are possible.

IUa discharge (CC+CV discharge) is also possible: in this case, the DUT is discharged with constant current until a defined voltage is detected. This voltage is then kept constant until a defined minimum current is reached.

Stop criteria are charge, energy, time, current, voltage.

During data logging, a follow-up time can be defined to observe the recovery phase.

### Charge Function

Similarly to the discharge function, there is the charge function, where the same operating modes and switch-off criteria apply.

### Cycling Function

During cycling, the charging and discharging functions are performed alternately with an adjustable number of cycles. A recovery time can be defined between the charging and discharging function.

### Adjustable Internal Resistance, Capacitance Simulation

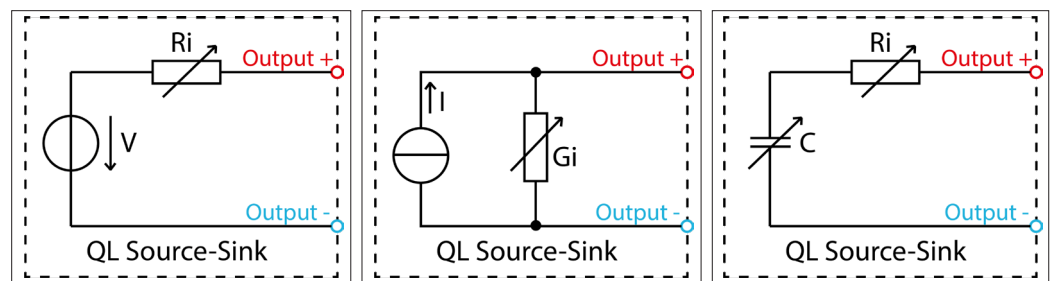

Voltage source with int. resistance

Current source with int. conductance

Capacity simulation

In order to simulate different sources as flexibly as possible, a variable internal resistance can be set in constant voltage mode CV, and analogously a conductance value in constant current mode CC.

In constant voltage mode, the source-sink can also simulate the behavior of a capacitance which charges or discharges with a certain initial voltage. In combination with an adjustable internal resistance, this allows batteries, electrolytic capacitors or other energy storage devices to be simulated and chargers to be tested.

## List Function

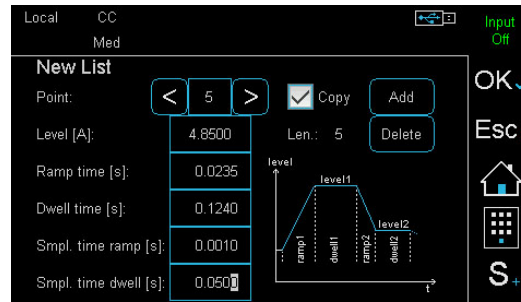

Voltage and current are measured synchronously and stored with a time stamp. Associated sampling times can be defined for each curve section.

In all operating modes current, voltage, power or resistance profiles can be simulated with the list function. Up to 300 settings of variable duration with associated ramp time are possible. The setting lists may contain positive and negative values cross-quadrant, so that there are e.g. charging and discharging currents in one list.

## Rectangular Function

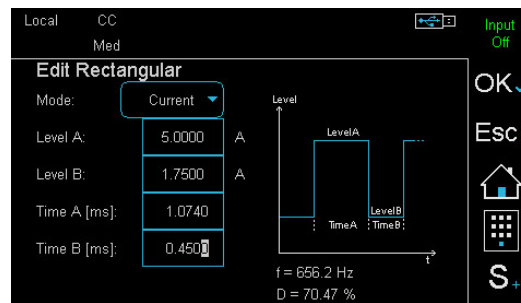

The rectangle function provides a convenient way to generate a rectangular waveform by entering absolute time and current/voltage values.

The rectangle function provides a convenient way to generate a rectangular waveform by entering absolute time and current/voltage values.

## PWM Function

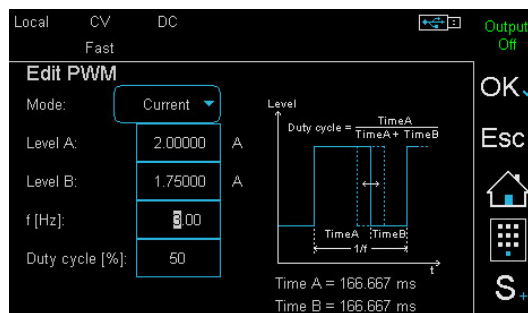

In manual operation of the PWM function, the frequency and the duty cycle can be set for the two current/voltage values.

## Modulator

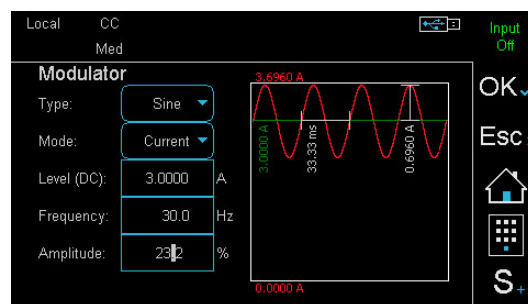

In CC or CV mode, the modulator adds a sinusoidal, square-wave, triangular or arbitrary signal to a constant setpoint. Frequency and modulation depth are adjustable.

## AC Source

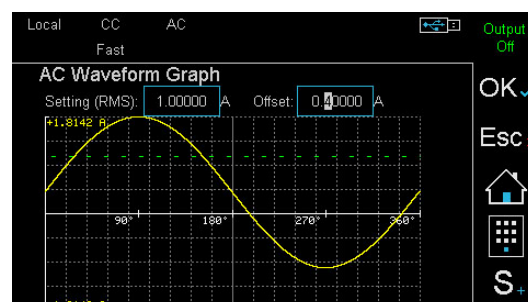

4-quadrant devices can be used as DC source-sinks in the basic operating modes CC, CV, CP and CR and additionally as AC sources in the operating modes CC and CV.

Selectable waveforms are sine, triangle, square, sawtooth or an arbitrary waveform with adjustable offset.

The waveform is mains synchronizable.

## Internal Resistance Measurement

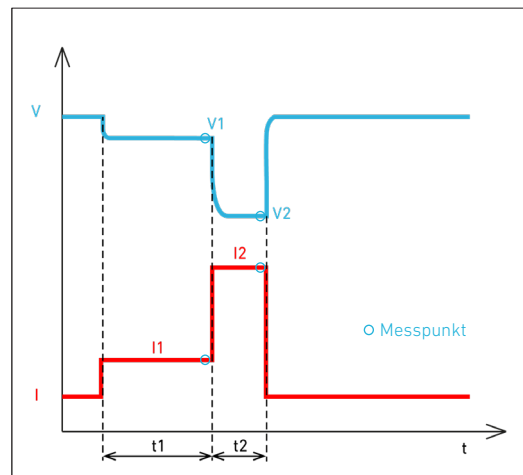

Ri calculation timing

The source-sink can measure the internal DC resistance of the connected DUT. The determination of the internal resistance  $R_i$  is based on the principle specified in various standards for batteries and accumulators, e.g. DIN EN 61951, DIN EN 61960. Within a defined period of time, the device measures the DUT's terminal voltage ( $V_1$ ,  $V_2$ ) at two adjustable currents ( $I_1$ ,  $I_2$ ) and calculates  $R_i$  from this. In manual mode, the device can store the parameters and the result of the measurement on a connected USB mass storage device at the touch of a button, so that a high throughput with many DUTs may be achieved.

## Data Acquisition (DAQ)

The source-sink is able to synchronously store data records from voltage and current with time stamp internally in a defined interval. Up to 40,000 data records are stored in a ring buffer and can be read via one of the data interfaces. After the recording is finished, the user may transfer data to a USB flash drive.

For processes with storage intervals in the seconds range, the device can also save data directly on the USB flash drive.

## Trigger Model

Several functions and settings may be triggered by a configurable trigger event:

- Set triggered output state
- Set triggered operating mode
- Start/stop list mode
- Start/stop data acquisition
- Set triggered settings of all operating modes

Available trigger sources:

- Extern
- Bus
- Manual
- Voltage
- Current

## Changing Regulation Speed

For certain DUTs or very long connecting lines, it may be necessary to adjust the regulation time constant of the source-sink to avoid oscillation behavior and to achieve stable operation.

The control speed can be selected from slow - fast (see rise/fall times in model overview).

## Watchdog Function

To protect the DUT from communication problems, the source-sink in digital remote control mode has a watchdog function that switches off the output if the previously programmed watchdog delay time expires without the watchdog being reset.

The watchdog delay time is set by SCPI command, another command activates the watchdog. When the watchdog is active, a control program must ensure that the command to reset the watchdog is periodically sent to the source-sink.

## Save Settings

In order to quickly reconstruct frequently recurring test tasks, the settings active in the source-sink can be stored non-volatile (internal or to USB flash drive) so that they can be reloaded later on. 9 internal memory positions are available.

When powered on, the source-sink can optionally set the reset state, the last active settings at power-off or memory positions 1 to 9.

## Drivers



Current NI-certified LabVIEW drivers can be downloaded here:  
[www.ni.com/downloads/instrument-drivers/](http://www.ni.com/downloads/instrument-drivers/)

## Hardware Extensions

### Option QL14<sup>1)</sup> Heavy-weight castors



Castors

Steerable castors (option QL14) can be screwed onto big devices for easier transport. This can often save a 19" rack. This option is available for devices from 5 U and is only suitable for hard floors.

### Option QL06<sup>1)</sup> Galvanically isolated I/O interface



In case of potential differences between the negative output and the signals at the I/O port, the standard I/O port can be exchanged for an isolated version. All control and measurement signals are routed via isolation amplifiers and optocouplers. The board is pin compatible to the standard I/O board.

1. Retrofittable at any time

Model (Order Number)	QL1V10C20	QL1V20C10	QL1V30C8	QL1V42C6	QL1V80C3	QL1V100C2
Voltage range	-1 ... 10 V	-1 ... 20 V	-1 ... 30 V	-1 ... 42 V	-1 ... 80 V	-1 ... 100 V
Current range	±20 A	±10 A	±8 A	±6 A	±3 A	±2 A
Resistance range	0.0250 ... 10.0 Ω	0.100 ... 40.0 Ω	0.200 ... 75.0 Ω	0.350 ... 140 Ω	1.33 ... 533 Ω	2.50 ... 1000.0 Ω
Power	200 W	200 W	240 W	252 W	240 W	200 W
Rise/fall time CC, CV <sup>1)</sup>	120 μs	120 μs	120 μs	120 μs	120 μs	120 μs
Bandwidth	3.0 kHz	3.0 kHz	3.0 kHz	3.0 kHz	3.0 kHz	3.0 kHz
Adjustable int. resistance CC <sup>2)</sup>	1.00 Ω ... ∞	4.00 Ω ... ∞	7.50 Ω ... ∞	14.0 Ω ... ∞	53.3 Ω ... ∞	100 Ω ... ∞
Adjustable int. resistance CV	0 ... 0.25 Ω	0 ... 1.00 Ω	0 ... 1.88 Ω	0 ... 3.50 Ω	0 ... 13.3 Ω	0 ... 25.0 Ω
Output terminals <sup>3)</sup> rear	BPK4-30L	BPK4-30L	BPK4-30L	BPK4-30L	BPK4-30L	BPK4-30L
Power consumption	430 VA	380 VA	400 VA	391 VA	363 VA	310 VA
Mains voltage <sup>4)</sup>	1/N/PE AC 230 V 50 ... 60 Hz	1/N/PE AC 230 V 50 ... 60 Hz	1/N/PE AC 230 V 50 ... 60 Hz	1/N/PE AC 230 V 50 ... 60 Hz	1/N/PE AC 230 V 50 ... 60 Hz	1/N/PE AC 230 V 50 ... 60 Hz
Mains voltage toggleable <sup>4)</sup>	1/N/PE AC 115 V 50 ... 60 Hz	1/N/PE AC 115 V 50 ... 60 Hz	1/N/PE AC 115 V 50 ... 60 Hz	1/N/PE AC 115 V 50 ... 60 Hz	1/N/PE AC 115 V 50 ... 60 Hz	1/N/PE AC 115 V 50 ... 60 Hz
Noise max. ca. <sup>5)</sup>	65 dB(A)	65 dB(A)	65 dB(A)	62 dB(A)	64 dB(A)	65 dB(A)
Weight ca.	13 kg	13 kg	13 kg	12.5 kg	12.5 kg	13 kg
Housing <sup>6)</sup>	19", 2 U	19", 2 U	19", 2 U	19", 2 U	19", 2 U	19", 2 U

Model (Order Number)	QL1V8C80	QL1V10C60	QL1V20C40	QL1V26C32	QL1V44C22	QL1V60C16
Voltage range	-1 ... 8 V	-1 ... 10 V	-1 ... 20 V	-1 ... 26 V	-1 ... 44 V	-1 ... 60 V
Current range	±80 A	±60 A	±40 A	±32 A	±22 A	±16 A
Resistance range	0.00500 ... 200 Ω	0.00800 ... 3.30 Ω	0.0250 ... 10.0 Ω	0.0406 ... 16.3 Ω	0.100 ... 40.0 Ω	0.188 ... 75.0 Ω
Power	640 W	600 W	800 W	832 W	968 W	960 W
Rise/fall time CC, CV <sup>1)</sup>	150 μs	120 μs	120 μs	120 μs	105 μs	120 μs
Bandwidth	2.5 kHz	3.0 kHz	3.0 kHz	3.0 kHz	3.0 kHz	3.0 kHz
Adjustable int. resistance CC <sup>2)</sup>	0.200 Ω ... ∞	0.333 Ω ... ∞	1.00 Ω ... ∞	1.63 Ω ... ∞	4.00 Ω ... ∞	7.50 Ω ... ∞
Adjustable int. resistance CV	0 ... 0.050 Ω	0 ... 0.083 Ω	0 ... 0.250 Ω	0 ... 0.406 Ω	0 ... 1.00 Ω	0 ... 1.88 Ω
Output terminals <sup>3)</sup> rear	FKS25/10-SM10	BPK4-60L	BPK4-60L	BPK4-60L	BPK4-30L	BPK4-30L
Power consumption	1,400 VA	1,200 VA	1,300 VA	1,200 VA	1,400 VA	1,300 VA
Mains voltage <sup>4)</sup>	1/N/PE AC 230 V 50 ... 60 Hz	1/N/PE AC 230 V 50 ... 60 Hz	1/N/PE AC 230 V 50 ... 60 Hz	1/N/PE AC 230 V 50 ... 60 Hz	1/N/PE AC 230 V 50 ... 60 Hz	1/N/PE AC 230 V 50 ... 60 Hz
Mains voltage toggleable <sup>4)</sup>	1/N/PE AC 115 V 50 ... 60 Hz	1/N/PE AC 115 V 50 ... 60 Hz	1/N/PE AC 115 V 50 ... 60 Hz	1/N/PE AC 115 V 50 ... 60 Hz	1/N/PE AC 115 V 50 ... 60 Hz	1/N/PE AC 115 V 50 ... 60 Hz
Noise max. ca. <sup>5)</sup>	71 dB(A)	68 dB(A)	68 dB(A)	67 dB(A)	70 dB(A)	67 dB(A)
Weight ca.	39 kg	33 kg	33 kg	23 kg	21 kg	23 kg
Housing <sup>6)</sup>	19", 5 U	19", 5 U	19", 5 U	19", 3 U	19", 3 U	19", 3 U

Model (Order Number)	QL1V80C11	QL1V8C160	QL1V10C120	QL1V20C80	QL1V26C60	QL1V44C40
Voltage range	-1 ... 80 V	-1 ... 8 V	-1 ... 10 V	-1 ... 20 V	-1 ... 26 V	-1 ... 44 V
Current range	±11 A	±160 A	±120 A	±80 A	±60 A	±40 A
Resistance range	0.364 ... 145 Ω	0.0025 ... 1.00 Ω	0.00417 ... 1.67 Ω	0.0125 ... 5.00 Ω	0.0217 ... 8.70 Ω	0.055 ... 22.0 Ω
Power	880 W	1,280 W	1,200 W	1,600 W	1,560 W	1,760 W
Rise/fall time CC, CV <sup>1)</sup>	120 μs	120 μs	120 μs	120 μs	120 μs	120 μs
Bandwidth	3.0 kHz	3.0 kHz	3.0 kHz	3.0 kHz	3.0 kHz	3.0 kHz
Adjustable int. resistance CC <sup>2)</sup>	14.5 Ω ... ∞	0.100 Ω ... ∞	0.167 Ω ... ∞	0.500 Ω ... ∞	0.867 Ω ... ∞	2.20 Ω ... ∞
Adjustable int. resistance CV	0 ... 3.64 Ω	0 ... 0.0250 Ω	0 ... 0.0417 Ω	0 ... 0.125 Ω	0 ... 0.217 Ω	0 ... 0.550 Ω
Output terminals <sup>3)</sup> rear	BPK4-30L	FKS25/10-SM10	FKS25/10-SM10	FKS25/10-SM10	BPK4-60L	BPK4-60L
Power consumption	1,330 VA	2,700 VA	2,400 VA	2,520 VA	2,550 VA	2,500 VA
Mains voltage <sup>4)</sup>	1/N/PE AC 230 V 50 ... 60 Hz	1/N/PE AC 230 V 50 ... 60 Hz	1/N/PE AC 230 V 50 ... 60 Hz	1/N/PE AC 230 V 50 ... 60 Hz	1/N/PE AC 230 V 50 ... 60 Hz	1/N/PE AC 230 V 50 ... 60 Hz
Mains voltage toggleable <sup>4)</sup>	1/N/PE AC 115 V 50 ... 60 Hz	-	-	-	-	-
Noise max. ca. <sup>5)</sup>	67 dB(A)	77 dB(A)	76 dB(A)	73 dB(A)	75 dB(A)	75 dB(A)
Weight ca.	23 kg	57 kg	59 kg	56 kg	51 kg	52 kg
Housing <sup>6)</sup>	19", 3 U	19", 8 U	19", 8 U	19", 8 U	19", 8 U	19", 8 U

- Rise and fall times are from 10 ... 90 % and 90 ... 10 % of the positive current (in CC mode) or voltage (in CV mode) setting range in "fast" regulation speed. Tolerance ±20 %. Measured with short-circuited output terminals (CC) or with open output terminals (CV). Other loads may increase rise/fall times. Rise/fall time in CP and CR mode: ca. 3 ms. Rise/fall time in "slow" regulation speed: ca. 2 ms in C and CV mode, ca. 20 ms in CP and CR mode.
- Value is entered as conductance in S.
- Description of available terminals beginning at page 123. Units with touchable terminals are supplied with safety covers.
- Mains voltage tolerance: ±10 %.
- Measured at the front in distance of 1 m.
- 1 U = 44.45 mm. Detailed dimensions by means of 3D models at [www.hoechertl-hackl.com/downloads](http://www.hoechertl-hackl.com/downloads).

Model (Order Number)	QL1V60C30	QL1V80C20	QL1V8C240	QL1V10C180	QL1V20C120	QL1V26C90
Voltage range	-1 ... 60 V	-1 ... 80 V	-1 ... 8 V	-1 ... 10 V	-1 ... 20 V	-1 ... 26 V
Current range	±30 A	±20 A	±240 A	±180 A	±120 A	±90 A
Resistance range	0.100 ... 40.0 Ω	0.200 ... 80.0 Ω	0.00167 ... 0.667 Ω	0.00278 ... 1.11 Ω	0.00833 ... 3.33 Ω	0.0144 ... 5.78 Ω
Power	1,800 W	1,600 W	1,920 W	1,800 W	2,400 W	2,340 W
Rise/fall time CC, CV <sup>1)</sup>	150 μs	120 μs	120 μs	120 μs	120 μs	120 μs
Bandwidth	2.5 kHz	3.0 kHz	3.0 kHz	3.0 kHz	3.0 kHz	3.0 kHz
Adjustable int. resistance CC <sup>2)</sup>	4.00 Ω ... ∞	8.00 Ω ... ∞	0.0667 Ω ... ∞	0.111 Ω ... ∞	0.333 Ω ... ∞	0.578 Ω ... ∞
Adjustable int. resistance CV	0 ... 1.00 Ω	0 ... 2.00 Ω	0 ... 0.0167 Ω	0 ... 0.0278 Ω	0 ... 0.0833 Ω	0 ... 0.144 Ω
Output terminals <sup>3)</sup> rear	BPK4-30L	BPK4-30L	FKS25/10-SM10	FKS25/10-SM10	FKS25/10-SM10	FKS25/10-SM10
Power consumption	2,750 VA	2,200 VA	4,340 VA	3,800 VA	3,800 VA	3,775 VA
Mains voltage <sup>4)</sup>	1/N/PE AC 230 V 50 ... 60 Hz	1/N/PE AC 230 V 50 ... 60 Hz	3/N/PE AC 400/230V 50 ... 60 Hz, 16 A	3/N/PE AC 400/230V 50 ... 60 Hz, 16 A	3/N/PE AC 400/230V 50 ... 60 Hz, 16 A	3/N/PE AC 400/230V 50 ... 60 Hz, 16 A
Mains voltage toggleable <sup>4)</sup>	-	-	-	-	-	-
Noise max. ca. <sup>5)</sup>	75 dB(A)	75 dB(A)	76 dB(A)	76 dB(A)	76 dB(A)	76 dB(A)
Weight ca.	52 kg	50 kg	81 kg	76 kg	76 kg	73 kg
Housing <sup>6)</sup>	19", 8 U	19", 8 U	19", 11 U	19", 11 U	19", 11 U	19", 11 U

Model (Order Number)	QL1V44C60	QL1V60C45	QL1V80C30	QL1V8C320	QL1V10C240	QL1V20C160
Voltage range	-1 ... 44 V	-1 ... 60 V	-1 ... 80 V	-1 ... 8 V	-1 ... 10 V	-1 ... 20 V
Current range	±60 A	±45 A	±30 A	±320 A	±240 A	±160 A
Resistance range	0.0367 ... 14.7 Ω	0.0667 ... 26.7 Ω	0.133 ... 53.3 Ω	0.00125 ... 0.500 Ω	0.00208 ... 0.833 Ω	0.00625 ... 2.50 Ω
Power	2,640 W	2,700 W	2,400 W	2,560 W	2,400 W	3,200 W
Rise/fall time CC, CV <sup>1)</sup>	120 μs	120 μs	120 μs	120 μs	150 μs	150 μs
Bandwidth	3.0 kHz	3.0 kHz	3.0 kHz	3.0 kHz	2.5 kHz	2.5 kHz
Adjustable int. resistance CC <sup>2)</sup>	1.47 Ω ... ∞	2.67 Ω ... ∞	5.33 Ω ... ∞	0.0500 Ω ... ∞	0.0833 Ω ... ∞	0.250 Ω ... ∞
Adjustable int. resistance CV	0 ... 0.367 Ω	0 ... 0.667 Ω	0 ... 1.33 Ω	0 ... 0.0125 Ω	0 ... 0.0208 Ω	0 ... 0.0625 Ω
Output terminals <sup>3)</sup> rear	BPK4-60L	BPK4-60L	BPK4-30L	FKS25/10-SM10	FKS25/10-SM10	FKS25/10-SM10
Power consumption	4,000 VA	4,060 VA	3,200 VA	5,300 VA	4,500 VA	5,100 VA
Mains voltage <sup>4)</sup>	3/N/PE AC 400/230V 50 ... 60 Hz, 16 A	3/N/PE AC 400/230V 50 ... 60 Hz, 16 A	3/N/PE AC 400/230V 50 ... 60 Hz, 16 A	3/N/PE AC 400/230V 50 ... 60 Hz, 16 A	3/N/PE AC 400/230V 50 ... 60 Hz, 16 A	3/N/PE AC 400/230V 50 ... 60 Hz, 16 A
Mains voltage toggleable <sup>4)</sup>	-	-	-	-	-	-
Noise max. ca. <sup>5)</sup>	76 dB(A)	76 dB(A)	76 dB(A)	76 dB(A)	76 dB(A)	76 dB(A)
Weight ca.	73 kg	75 kg	73 kg	99 kg	100 kg	96 kg
Housing <sup>6)</sup>	19", 11 U	19", 11 U	19", 11 U	19", 14 U	19", 14 U	19", 14 U

Model (Order Number)	QL1V26C120	QL1V44C80	QL1V60C60	QL1V80C40
Voltage range	-1 ... 26 V	-1 ... 44 V	-1 ... 60 V	-1 ... 80 V
Current range	±120 A	±80 A	±60 A	±40 A
Resistance range	0.0108 ... 4.33 Ω	0.0275 ... 11.0 Ω	0.0500 ... 20.0 Ω	0.100 ... 40.0 Ω
Power	3,120 W	3,520 W	3,600 W	3,200 W
Rise/fall time CC, CV <sup>1)</sup>	150 μs	120 μs	150 μs	150 μs
Bandwidth	2.5 kHz	3.0 kHz	2.5 kHz	2.5 kHz
Adjustable int. resistance CC <sup>2)</sup>	0.433 Ω ... ∞	1.10 Ω ... ∞	2.00 Ω ... ∞	4.00 Ω ... ∞
Adjustable int. resistance CV	0 ... 0.108 Ω	0 ... 0.275 Ω	0 ... 0.500 Ω	0 ... 1.00 Ω
Output terminals <sup>3)</sup> rear	FKS25/10-SM10	FKS25/10-SM10	BPK4-60L	BPK4-60L
Power consumption	4,800 VA	4,900 VA	4,800 VA	4,400 VA
Mains voltage <sup>4)</sup>	3/N/PE AC 400/230V 50 ... 60 Hz, 16 A	3/N/PE AC 400/230V 50 ... 60 Hz, 16 A	3/N/PE AC 400/230V 50 ... 60 Hz, 16 A	3/N/PE AC 400/230V 50 ... 60 Hz, 16 A
Mains voltage toggleable <sup>4)</sup>	-	-	-	-
Noise max. ca. <sup>5)</sup>	76 dB(A)	76 dB(A)	76 dB(A)	76 dB(A)
Weight ca.	96 kg	93 kg	93 kg	96 kg
Housing <sup>6)</sup>	19", 14 U	19", 14 U	19", 14 U	19", 14 U

1. Rise and fall times are from 10 ... 90 % and 90 ... 10 % of the positive current (in CC mode) or voltage (in CV mode) setting range in "fast" regulation speed. Tolerance ±20 %. Measured with short-circuited output terminals (CC) or with open output terminals (CV). Other loads may increase rise/fall times. Rise/fall time in CP and CR mode: ca. 3 ms. Rise/fall time in "slow" regulation speed: ca. 2 ms in C and CV mode, ca. 20 ms in CP and CR mode.
2. Value is entered as conductance in S.
3. Description of available terminals beginning at page 123. Units with touchable terminals are supplied with safety covers.
4. Mains voltage tolerance: ±10 %.
5. Measured at the front in distance of 1 m.
6. 1 U = 44.45 mm. Detailed dimensions by means of 3D models at [www.hoechert-hackl.com/downloads](http://www.hoechert-hackl.com/downloads).



Model (Order Number)	QL10V10C10	QL20V20C5	QL30V30C3.5	QL50V50C2	QL8V8C46	QL10V10C38
Voltage range	±10 V	±20 V	±30 V	±50 V	±8 V	±10 V
Current range	±10 A	±5 A	±3,5 A	±2 A	±46 A	±38 A
Resistance range	0.0500 ... 20.0 Ω	0.200 ... 80.0 Ω	0.429 ... 171.4 Ω	1.250 ... 500 Ω	0.00870 ... 3.48 Ω	0.0132 ... 5.26 Ω
Power	100 W	100 W	105 W	100 W	368 W	380 W
Rise/fall time CC, CV <sup>1)</sup>	110 μs	120 μs	100 μs	120 μs	120 μs	120 μs
Bandwidth	3.0 kHz	3.0 kHz	3.0 kHz	3.0 kHz	3.0 kHz	3.0 kHz
Adjustable int. resistance CC <sup>2)</sup>	2.00 Ω ... ∞	8.00 Ω ... ∞	17.1 Ω ... ∞	50.0 Ω ... ∞	0.348 Ω ... ∞	0.526 Ω ... ∞
Adjustable int. resistance CV	0 ... 0.50 Ω	0 ... 2.00 Ω	0 ... 4.29 Ω	0 ... 12.5 Ω	0 ... 0.087 Ω	0 ... 0.132 Ω
Output terminals <sup>3)</sup> rear	BPK4-30L	BPK4-30L	BPK4-30L	BPK4-30L	BPK4-60L	BPK4-30L
Power consumption	250 VA	218 VA	205 VA	215 VA	800 VA	750 VA
Mains voltage <sup>4)</sup>	1/N/PE AC 230 V 50 ... 60 Hz	1/N/PE AC 230 V 50 ... 60 Hz	1/N/PE AC 230 V 50 ... 60 Hz	1/N/PE AC 230 V 50 ... 60 Hz	1/N/PE AC 230 V 50 ... 60 Hz	1/N/PE AC 230 V 50 ... 60 Hz
Mains voltage toggleable <sup>4)</sup>	1/N/PE AC 115 V 50 ... 60 Hz	1/N/PE AC 115 V 50 ... 60 Hz	1/N/PE AC 115 V 50 ... 60 Hz	1/N/PE AC 115 V 50 ... 60 Hz	1/N/PE AC 115 V 50 ... 60 Hz	1/N/PE AC 115 V 50 ... 60 Hz
Noise max. ca. <sup>5)</sup>	64 dB(A)	62 dB(A)	65 dB(A)	65 dB(A)	67 dB(A)	67 dB(A)
Weight ca.	13 kg	12.5 kg	13 kg	13 kg	23 kg	23 kg
Housing <sup>6)</sup>	19", 2 U	19", 2 U	19", 2 U	19", 2 U	19", 3 U	19", 3 U

Model (Order Number)	QL20V20C24	QL30V30C16	QL44V44C11	QL8V8C80	QL10V10C60	QL20V20C40
Voltage range	±20 V	±30 V	±44 V	±8 V	±10 V	±20 V
Current range	±24 A	±16 A	±11 A	±80 A	±60 A	±40 A
Resistance range	0.0417 ... 16.7 Ω	0.0938 ... 37.5 Ω	0.200 ... 80.0 Ω	0.00500 ... 2.00 Ω	0.00833 ... 3.33 Ω	0.0250 ... 10.0 Ω
Power	480 W	432 W	484 W	640 W	600 W	800 W
Rise/fall time CC, CV <sup>1)</sup>	120 μs	120 μs	110 μs	150 μs	120 μs	150 μs
Bandwidth	3.0 kHz	3.0 kHz	3.0 kHz	2.5 kHz	3.0 kHz	2.5 kHz
Adjustable int. resistance CC <sup>2)</sup>	1.67 Ω ... ∞	3.75 Ω ... ∞	8.00 Ω ... ∞	0.200 Ω ... ∞	0.333 Ω ... ∞	1.00 Ω ... ∞
Adjustable int. resistance CV	0 ... 0.417 Ω	0 ... 0.938 Ω	0 ... 2.00 Ω	0 ... 0.0500 Ω	0 ... 0.0833 Ω	0 ... 0.250 Ω
Output terminals <sup>3)</sup> rear	BPK4-30L	BPK4-30L	BPK4-30L	FKS25/10-SM10	BPK4-60L	BPK4-60L
Power consumption	780 VA	770 VA	715 VA	1,360 VA	1,325 VA	1,390 VA
Mains voltage <sup>4)</sup>	1/N/PE AC 230 V 50 ... 60 Hz	1/N/PE AC 230 V 50 ... 60 Hz	1/N/PE AC 230 V 50 ... 60 Hz	1/N/PE AC 230 V 50 ... 60 Hz	1/N/PE AC 230 V 50 ... 60 Hz	1/N/PE AC 230 V 50 ... 60 Hz
Mains voltage toggleable <sup>4)</sup>	1/N/PE AC 115 V 50 ... 60 Hz	1/N/PE AC 115 V 50 ... 60 Hz	1/N/PE AC 115 V 50 ... 60 Hz	1/N/PE AC 115 V 50 ... 60 Hz	1/N/PE AC 115 V 50 ... 60 Hz	1/N/PE AC 115 V 50 ... 60 Hz
Noise max. ca. <sup>5)</sup>	68 dB(A)	67 dB(A)	70 dB(A)	77 dB(A)	77 dB(A)	76 dB(A)
Weight ca.	22 kg	23 kg	22 kg	54 kg	55 kg	49 kg
Housing <sup>5)</sup>	19", 3 U	19", 3 U	19", 3 U	19", 8 U	19", 8 U	19", 8 U

Model (Order Number)	QL30V30C32	QL44V44C20	QL8V8C120	QL10V10C90	QL20V20C60	QL30V30C48
Voltage range	±30 V	±44 V	±8 V	±10 V	±20 V	±30 V
Current range	±32 A	±20 A	±120 A	±90 A	±60 A	±48 A
Resistance range	0.0469 ... 18.8 Ω	0.110 ... 44.0 Ω	0.00333 ... 1.33 Ω	0.00556 ... 2.22 Ω	0.0167 ... 6.67 Ω	0.0313 ... 12.5 Ω
Power	960 W	880 W	960 W	900 W	1,200 W	1,440 W
Rise/fall time CC, CV <sup>1)</sup>	120 μs	120 μs	150 μs	150 μs	120 μs	120 μs
Bandwidth	3.0 kHz	3.0 kHz	2.5 kHz	2.5 kHz	3.0 kHz	3.0 kHz
Adjustable int. resistance CC <sup>2)</sup>	1.188 Ω ... ∞	4.40 Ω ... ∞	0.133 Ω ... ∞	0.222 Ω ... ∞	0.667 Ω ... ∞	1.25 Ω ... ∞
Adjustable int. resistance CV	0 ... 0.469 Ω	0 ... 1.10 Ω	0 ... 0.0333 Ω	0 ... 0.0556 Ω	0 ... 0.167 Ω	0 ... 0.313 Ω
Output terminals <sup>3)</sup> rear	BPK4-60L	BPK4-30L	FKS25/10-SM10	FKS25/10-SM10	FKS25/10-SM10	BPK4-60L
Power consumption	1,560 VA	1,400 VA	2,200 VA	2,088 VA	2,200 VA	2,340 VA
Mains voltage <sup>4)</sup>	1/N/PE AC 230 V 50 ... 60 Hz	1/N/PE AC 230 V 50 ... 60 Hz	1/N/PE AC 230 V 50 ... 60 Hz	1/N/PE AC 230 V 50 ... 60 Hz	1/N/PE AC 230 V 50 ... 60 Hz	1/N/PE AC 230 V 50 ... 60 Hz
Mains voltage toggleable <sup>4)</sup>	1/N/PE AC 115 V 50 ... 60 Hz	1/N/PE AC 115 V 50 ... 60 Hz	-	-	-	-
Noise max. ca. <sup>5)</sup>	67 dB(A)	67 dB(A)	73 dB(A)	77 dB(A)	77 dB(A)	76 dB(A)
Weight ca.	49 kg	55 kg	80 kg	80 kg	80 kg	80 kg
Housing <sup>6)</sup>	19", 8 U	19", 8 U	19", 11 U	19", 11 U	19", 11 U	19", 11 U

1. Rise and fall times are from 10 ... 90 % and 90 ... 10 % of the positive current (in CC mode) or voltage (in CV mode) setting range in "fast" regulation speed. Tolerance ±20 %. Measured with short-circuited output terminals (CC) or with open output terminals (CV). Other loads may increase rise/fall times. Rise/fall time in CP and CR mode: ca. 3 ms. Rise/fall time in "slow" regulation speed: ca. 2 ms in C and CV mode, ca. 20 ms in CP and CR mode.
2. Value is entered as conductance in S.
3. Description of available terminals beginning at page 123. Units with touchable terminals are supplied with safety covers.
4. Mains voltage tolerance: ±10 %.
5. Measured at the front in distance of 1 m.
6. 1 U = 44.45 mm. Detailed dimensions by means of 3D models at [www.hoecherl-hackl.com/downloads](http://www.hoecherl-hackl.com/downloads).

Model (Order Number)	QL44V44C30	QL8V8C160	QL10V10C120	QL20V20C80	QL30V30C64	QL44V44C40
Voltage range	±44 V	±8 V	±10 V	±20 V	±30 V	±44 V
Current range	±30 A	±160 A	±120 A	±80 A	±64 A	±40 A
Resistance range	0.0733 ... 29.3 Ω	0.00250 ... 1.00 Ω	0.00417 ... 1.67 Ω	0.0125 ... 5.00 Ω	0.0234 ... 9.38 Ω	0.0550 ... 22.0 Ω
Power	1,320 W	1,280 W	1,200 W	1,600 W	1,920 W	1,760 W
Rise/fall time CC, CV <sup>1)</sup>	120 μs	120 μs	150 μs	150 μs	120 μs	120 μs
Bandwidth	3.0 kHz	3.0 kHz	2.5 kHz	2.5 kHz	3.0 kHz	3.0 kHz
Adjustable int. resistance CC <sup>2)</sup>	2.93 Ω ... ∞	0.100 Ω ... ∞	0.167 Ω ... ∞	0.500 Ω ... ∞	0.938 Ω ... ∞	2.20 Ω ... ∞
Adjustable int. resistance CV	0 ... 0.733 Ω	0 ... 0.0250 Ω	0 ... 0.0417 Ω	0 ... 0.125 Ω	0 ... 0.234 Ω	0 ... 0.550 Ω
Output terminals <sup>3)</sup> rear	BPK4-30L	FKS25/10-SM10	FKS25/10-SM10	FKS25/10-SM10	FKS25/10-SM10	BPK4-60L
Power consumption	2,200 VA	2,830 VA	2,550 VA	2,700 VA	3,020 VA	2,700 VA
Mains voltage <sup>4)</sup>	1/N/PE AC 230 V 50 ... 60 Hz	1/N/PE AC 230 V 50 ... 60 Hz	1/N/PE AC 230 V 50 ... 60 Hz	1/N/PE AC 230 V 50 ... 60 Hz	1/N/PE AC 230 V 50 ... 60 Hz	1/N/PE AC 230 V 50 ... 60 Hz
Mains voltage toggleable <sup>4)</sup>	-	-	-	-	-	-
Noise max. ca. <sup>5)</sup>	76 dB(A)	74 dB(A)	76 dB(A)	76 dB(A)	76 dB(A)	76 dB(A)
Weight ca.	80 kg	97 kg	92 kg	92 kg	92 kg	92 kg
Housing <sup>6)</sup>	19", 11 U	19", 14 U	19", 14 U	19", 14 U	19", 14 U	19", 14 U

## Options and Accessories

Order Number	Article	Description
67-004-030-27	K-RS-SNM 9-9	RS-232 cable (null-modem cable)
52-200-001-27	QL02	GPIO interface
53-100-002-27	QL06-N	Galvanically isolated I/O port instead of standard I/O port with new device
53-100-001-27	QL06	Galvanically isolated I/O port for retrofitting at existing device
64-400-000-27	QL14	Heavy-weight castors for devices from 5 U
67-008-020-27	K-MS-QL+K-MS-CAN	Cable set master-slave, consisting of K-MS-QL and K-MS-CAN (2 m each)
63-000-005-27	PH2/7.62-ST16	Additional mating connector for sense terminal
63-000-006-27	SubD25 Doubler	Adapter 1x Sub-D25 male connector to 2x Sub-D25 female connector for I/O port
65-002-000-27	FCC-QLxx	Factory Calibration Certificate
64-402-000-27	SAB-QL-3	Additional safety cover for devices with 3 U
64-403-000-27	SAB-QL-5	Additional safety cover for devices from 5 U
63-000-007-00	SENSADAPT/PH4/ POK/60V	Sense-Adapter from Phoenix PH4 to 4 mm binding post, max. 60 V
63-000-008-00	SENSADAPT/PH4/ POK/1200V	Sense-Adapter from Phoenix PH4 to 4 mm touch-protected binding post, max. 1200 V
		Load cables see starting at page 127.

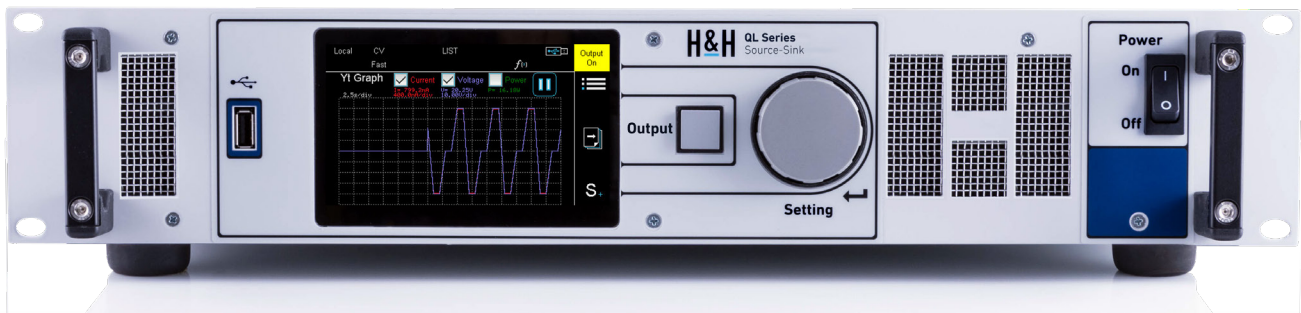

1. Rise and fall times are from 10 ... 90 % and 90 ... 10 % of the positive current (in CC mode) or voltage (in CV mode) setting range in "fast" regulation speed. Tolerance ±20 %. Measured with short-circuited output terminals (CC) or with open output terminals (CV). Other loads may increase rise/fall times. Rise/fall time in CP and CR mode: ca. 3 ms. Rise/fall time in "slow" regulation speed: ca. 2 ms in C and CV mode, ca. 20 ms in CP and CR mode.
2. Value is entered as conductance in S.
3. Description of available terminals beginning at page 123. Units with touchable terminals are supplied with safety covers.
4. Mains voltage tolerance: ±10 %.
5. Measured at the front in distance of 1 m.
6. 1 U = 44.45 mm. Detailed dimensions by means of 3D models at [www.hoecherl-hackl.com/downloads](http://www.hoecherl-hackl.com/downloads).

Operating modes, functions		
Basic operating modes	CC, CP, CR, CV	
Combined operating modes	CC+CV, CV+CC, CP+CV, CR+CV	
Functions	DC source-sink energy storage device test internal resistance measurement list function adjustable internal resistance capacitance simulation function rectangular function (also in PWM mode) modulation (sine, triangle, square, arbitrary) data acquisition (internally or to USB flash drive) save and recall of device settings watchdog in remote operation AC source (only with 4-quadrant models)	
AC source (only 4Q models)	in CC, CV mode (sine, triangular, square, sawtooth, arbitrary) range values are peak values for V and I adjustable offset	
Frequency range <sup>1)</sup>	0.1 Hz ... 10 kHz, also mains synchronizable	
User interface	4,3" TFT touch display	
Accuracy of setting DC		
	of setting	of corresponding positive range
Voltage	±0.1 %	±0.05 %
Current	±0.2 %	±0.05 %
Resistance (at  V  > 5 % of positive voltage range)	±1.4 %	±0.3 % of current range
Power (at  V  and  I  > 30 % of corresp. pos. range) (at  V  and  I  > 5 % and < 30 % of corresp. pos. range)	±0.35 % ±0.7 %	±0.1 % ±0.25 %
Resolution	15 bits in each quadrant	
Ripple voltage	ca. 0.4 % p-p of positive voltage range	
Ripple current	ca. 0.4 % p-p of positive voltage range	
Accuracy of setting AC (only 4-quadrant models)		
	of setting	of corresponding positive range
Voltage (RMS) <sup>1) 2)</sup>	±3 %	±0.25 %
Current (RMS) <sup>1) 2)</sup>	±3 %	±0.25 %
Accuracy of adjustable protections		
	of setting	of corresponding positive range
Current protection	±0.2 %	±0.05 %
Voltage protection	±0.1 %	±0.05 %
Resolution	13 bits in each quadrant	
Accuracy of measurement DC		
	of measured value (real value)	of corresponding positive range
Voltage	±0.1 %	±0.05 %
Current	±0.2 %	±0.05 %
Ext. control signal	±0.2 %	±0.1 %
Resistance	is calculated from current and voltage	
Power	is calculated from current and voltage	
Resolution	15 bits in each quadrant	
Sampling time	200 µs, triggerable	
Accuracy of measurement AC		
	of measured value (real value)	of corresponding positive range
Voltage (RMS)	±0.5 %	±0.1 %
Current (RMS)	±0.5 %	±0.1 %
Time constant of RMS measurement	ca. 500 ms	
Accuracy of display		
No. of dec. places	4	
Accuracy	accuracy of measurement DC/AC ±1 digit of display value	

Accuracy of trigger voltage and current	
Trigger voltage	±1 % of positive voltage range
Trigger current	±1 % of positive current range
Sampling time	200 µs
Dynamic function LIST	
Operating modes	CC, CV, CR, CP
No. of settings	max. 300, with corresponding ramp, dwell and sample times
Dwell time <sup>1)</sup>	200 µs ... 1,000 s
Ramp time <sup>1)</sup>	0 ... 1,000 s
Resolution	200 µs
Accuracy of setting times	±0.02 %
Delay at triggered start	max. 300 µs
Dynamic function rectangular	
Operating modes	CC, CV
No. of levels	2
Pulse times <sup>1)</sup> , resolution	1 µs ... 9,999,999 ms, resolution 1 µs
Accuracy of setting times	±0.02 %
Dynamic function PWM	
Operating modes	CC, CV
No. of levels	2
Frequency <sup>1)</sup> , resolution	0.1 Hz ... 10 kHz, resolution 0.1 Hz
Accuracy of frequency	±0.02 %
Duty cycle, resol.	1 ... 99 %, resolution 1 %
Dynamic function modulation	
Operating modes	CC, CV
Waveforms	Sine, square, triangular, arbitrary (1,024 points)
Frequency <sup>1)</sup> , resol.	0.1 Hz ... 10 kHz, resolution 0.1 Hz
Accuracy of frequency	±0.01 %
Modulation depth	0 ... 100 %
Capacitance simulation function	
Capacitance	10 mF ... 99999,99 F
Data acquisition	
to external USB flash drive	
Sampling time	0.1 ... 30.0 s, resolution 0.1 s
Measurement data	timestamp, voltage, current
No. of measurement points	limited by flash drive memory capacity
File format	.csv
to internal memory	
Sampling time	200 µs ... 1,000 s, resolution 200 µs, synchronized with dynamic function
Measurement data	timestamp, voltage, current
No. of meas. points	max. 40,000
Settings memory	
No. of memory positions	9, selectable (incl. programmed list) 1 for last device settings at power-off or power failure
I/O port: inputs and outputs	
Inputs	analog setting I and V with -5 ... 0 ... 5 V or -10 ... 0 ... 10 V analog protection setting I or V with -10 ... 0 ... 10 V output activation operating mode CC/CV control speed selection slow/fast remote shut-down readable digital input (by SCPI command) trigger input control input (activates I/O port)

The specified accuracies refer to an ambient temperature of 23 ±5 °C. The specified accuracies are valid when the sense lines are connected. At voltages with higher disturbance values the accuracy can change for the worse.

1. The applicable time or frequency range is limited by the bandwidth of the respective device.
2. at 50 ... 60 Hz
3. only -10 V ... 0 ... 10 V
4. positive/negative DC voltage or RMS value of a sinusoidal AC voltage

## Technical Data

Digital input level	logical low: 0 ... 0.8 V, logical high: 3 ... 30 V
Outputs	analog voltage monitor output -10 ... 0 ... 10 V analog current monitor output -10 ... 0 ... 10 V output activation state status output for upper protection value V or I status output for lower protection value V or I trigger output
Digital output level	logical low: 0 ... 0.8 V logical high: 5 V/24 V selectable, max. 10 mA (push-pull)

### I/O port: accuracy of analog control -5 ... 0 ... 5 V or -10 ... 0 ... 10 V

	of setting	of corresponding positive range
Voltage	±0.2 %	±0.1 %
Current	±0.2 %	±0.1 %
Resistance (at  V  > 5 % of positive voltage range)	±1.6 %	±0.4 % of current range
Power (at  V  and  I  > 30 % of corresp. pos. range) (at  V  and  I  > 5 % and < 30 % of corresp. pos. range)	±0.55 % ±0.9 %	±0.2 % ±0.35 %
Current protection <sup>3)</sup>	±1 %	±0.4 %
Voltage protection <sup>3)</sup>	±1 %	±0.4 %
	input resistance of analog inputs > 10 kΩ	

### I/O port: accuracy of analog monitor outputs -10 ... 0 ... 10 V

	of analog signal of actual value	offset voltage
Voltage	±0.2 %	±15 mV
Current	±0.2 %	±15 mV
	permissible load > 2 kΩ	

### I/O port: permissible voltages

	standard I/O port	isolated I/O port (option QL06)
V <sub>out-io</sub> (GND - neg. output)	max. 2 V <sup>4)</sup>	max. 125 V <sup>4)</sup>
V <sub>ioPE</sub> (GND - PE)	max. 125 V <sup>4)</sup>	max. 125 V <sup>4)</sup>

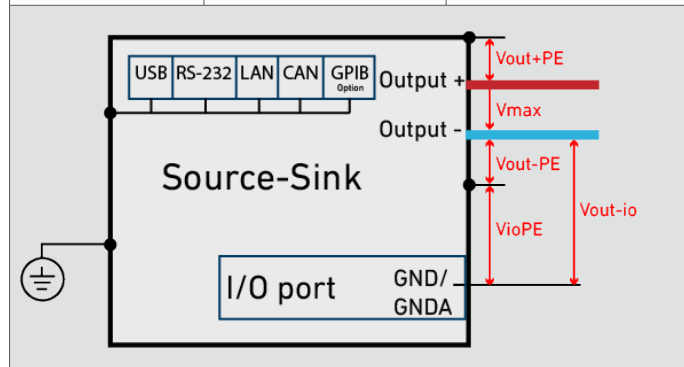

### Output

Output resistance	>50 kΩ when output is off
Max. output voltage V <sub>max</sub>	see model overview
Min. output voltage V <sub>min</sub>	see model overview

### Output: permissible voltages

	standard I/O port	isolated I/O port (option QL06)
V <sub>out-PE</sub> (neg. output - PE)	max. 125 V <sup>4)</sup>	max. 125 V <sup>4)</sup>
V <sub>out+PE</sub> (pos. output - PE)	V <sub>max</sub> + max. 125 V <sup>4)</sup>	V <sub>max</sub> + max. 125 V <sup>4)</sup>

### Power

Nominal power	see model overview (at T <sub>a</sub> = 21 °C)
Derating	-1.2 %/°C for T <sub>a</sub> > 21 °C

The specified accuracies refer to an ambient temperature of 23 ± 5 °C. The specified accuracies are valid when the sense lines are connected. At voltages with higher disturbance values the accuracy can change for the worse.

- The applicable time or frequency range is limited by the bandwidth of the respective device.
- at 50 ... 60 Hz
- only -10 V ... 0 ... 10 V
- positive/negative DC voltage or RMS value of a sinusoidal AC voltage

Protection and monitoring	
Protective devices	overcurrent overtemperature
Monitoring	overvoltage indication

### Terminals

Output	see model overview
Sense	PH4/3.5-ST8, see starting at page 123

### Operating conditions

Operating temperature	5 ... 40 °C
Stock temperature	-25 ... 65 °C
Max. operating height	2,000 m above sea level
Pollution degree	2
Overvoltage category of mains	II
Max. humidity	80 % at 31 °C, linear decreasing to 50 % at 40 °C
Min. distance rear panel to wall or other objects	70 cm
Cooling	temperature-controlled air cooling
Noise, weight	see model overview
Mains voltage	see model overview
Mains cable	length max. 3 m cross-section of mains leads min. 1 mm <sup>2</sup>
Power consumption	see model overview

### Housing

Size	see model overview
Color front rear top, side panels	RAL7035 (light grey) stainless steel RAL7037 (dusty grey)

### Safety and EMC

Protection class	1
Measuring category	0 (CAT I according to EN 61010:2004)
Electrical safety	DIN EN 61010-1 DIN EN 61010-2-030
EMC	DIN EN 61326-1 DIN EN 55011 DIN EN 61000-3-2 DIN EN 61000-3-3

### Standard interfaces

Data interfaces	RS-232, USB, LAN, CAN
I/O port	standard (not isolated)

### Available options

Data interface QL02	GPIB
Hardware extensions QL06 QL14	galvanically isolated I/O port heavy-weight castors for models from 5 U

### Calibration, warranty

FCC-QLxx	Factory Calibration Certificate, twice for free after registration
Recommended calibration interval	2 years
Warranty	2 years

Technical data of production series B, rev. 6. Subject to technical changes without notice.