

# PRODUCT DATA

## Miniature DeltaTron<sup>®</sup> Accelerometer — Type 4397A DeltaTron Accelerometers — Types 4398A, 4399A

*DeltaTron is the generic name for the family of accelerometers and signal conditioning products from Brüel & Kjær that operate on a constant-current power supply and give output signals in the form of voltage modulation on the power supply line.*

### FEATURES

- All DeltaTron products operate on constant-current line-drive (CCLD) ICP<sup>®</sup> principles
- All accelerometers have:
  - Integral preamplifiers
  - All-welded construction
  - Delta Shear Uni-Gain<sup>®</sup> design
  - Low sensitivity to all environments
  - Individual standard-traceable calibration
  - Individual data for best fit to measured frequency response

### USES

- Shock and vibration measurement
- Vibration analysis
- Vibration monitoring
- Vibration test control
- Product and quality control



## Description

*The DeltaTron name identifies products that operate with a constant-current power supply and give output signals in the form of voltage modulation on the power supply line. These DeltaTron accelerometers are constructed to the proven Brüel & Kjær Delta Shear design with the addition of an integral DeltaTron preamplifier. They require an external constant-current power supply and operate as voltage sources. They are specially designed to withstand rough environment.*

### Miniature Accelerometer Type 4397A

Suitable for measurements on lightweight structures where relatively high-level, high-frequency vibrations are encountered. Type 4397A uses a M3 connector.

### Shock and Vibration Accelerometer Type 4398A

Designed for the measurement of relatively high levels of continuous vibration and mechanical shock up to  $7500 \text{ ms}^{-2}$ . Type 4398A uses a 10–32 UNF Connector.

### General Purpose Accelerometer Type 4399A

For general purpose vibration measurements. Type 4399A uses a 10–32 UNF Connector.

Type numbers without an A-suffix include a connection cable.

**4397A/–8A/–9A**

Fig. 1 Exploded view of DeltaShear design (preamplifier not shown)

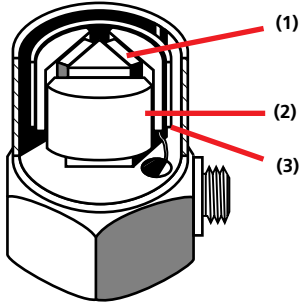

## DeltaShear® design

Three piezoelectric elements (1) and three seismic masses (2) are arranged in a triangular configuration around a triangular centre post. They are held in place using a high-tensile clamping ring (3). The DeltaShear design gives a high sensitivity-to-mass ratio compared to other designs, and has a relatively high resonance frequency and high isolation from base strains and temperature transients. The excellent overall characteristics of this design make it ideal for both general purpose accelerometers and more specialised types. A single-pole filter at the input of the built-in preamplifier extends the accelerometer's usable frequency range to approximately 50% of the mounted resonance frequency. Special efforts have been made to minimise interference from RF (radio frequency) electromagnetic fields.

## Characteristics

The accelerometers are supplied with individual calibration charts.

Fig. 2 Example of the calibration chart supplied with Brüel & Kjær DeltaTron accelerometers

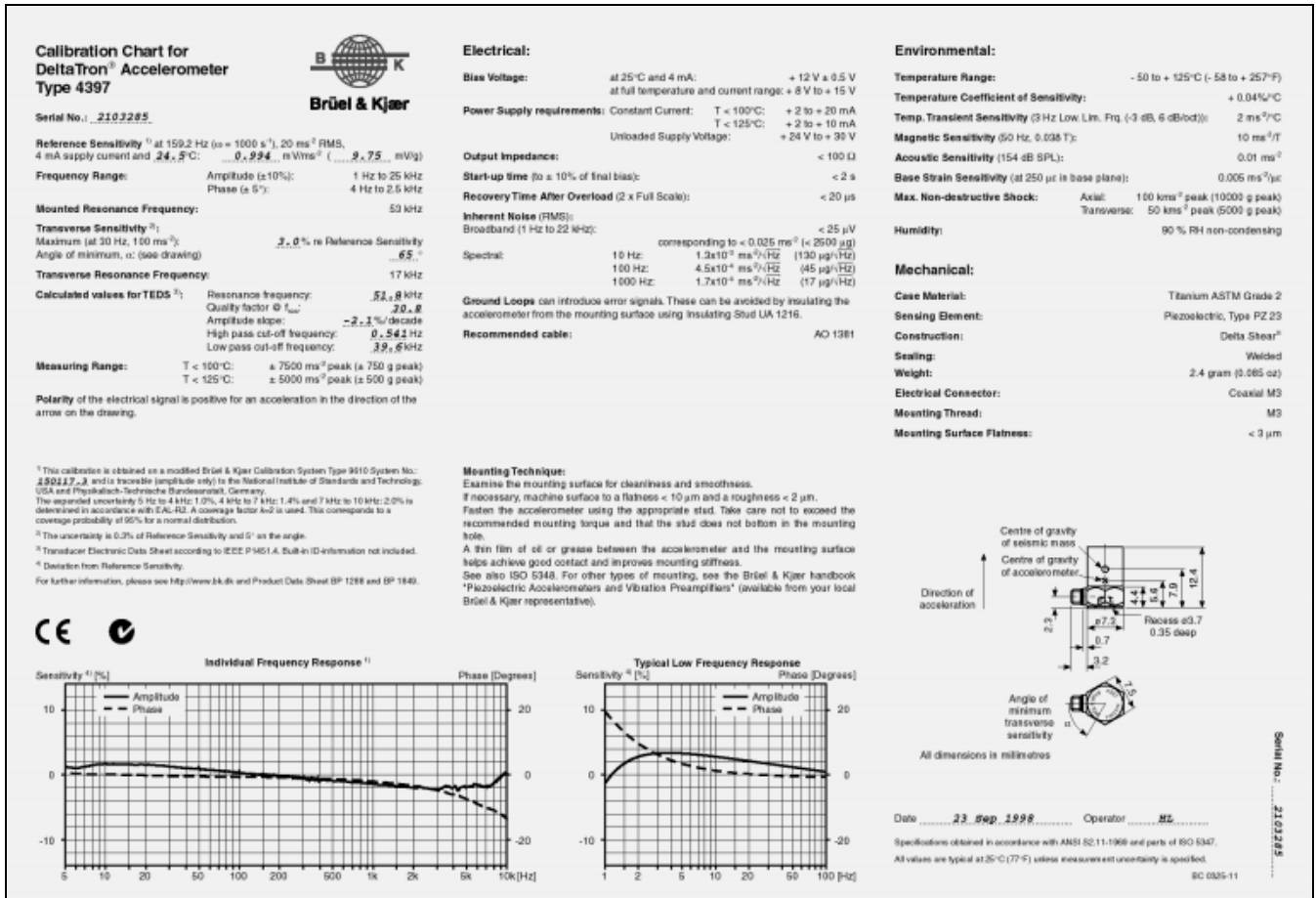

## Uni-Gain Sensitivity

The Brüel & Kjær Uni-Gain design means that the accelerometer sensitivity is adjusted during manufacture to within 2% of either 1 or 10 mV/ms<sup>-2</sup>.

## Frequency Response

The upper frequency limits given in the specifications are the frequencies where the deviation from the reference sensitivity is less than 10%. It is approximately 50% of the mounted resonance frequency. This assumes that the accelerometer is correctly mounted onto the test structure – a poor mounting can have a marked effect on the mounted resonance frequency.

The lower frequency limits and phase response are determined by the built-in preamplifiers. The lower frequency limits are given in the specifications for deviations from reference sensitivity of less than 10%.

Increased measurement accuracy can be achieved by dividing the actual measurement with the individual frequency response.

The frequency response curves given on the calibration chart are individually measured over most of the frequency range. At low frequencies, the curves given are typical (Fig. 2).

The calibration chart also includes individual data that, together with a general formula, best fits the measured frequency response. The expression can be used for frequency response compensation in the specified frequency range. The relative frequency response including amplitude and phase is:

$$S_{rel}(f, T) = (Sign)(1 + b(T - T_{ref})) \times \frac{j \frac{f}{f_{hp}}}{\left(1 + j \frac{f}{f_{hp}}\right)} \times \frac{1}{\left(1 + j \frac{f}{f_{lp}}\right)} \times \frac{1}{\left(1 + \left(j \frac{f}{f_{res}}\right)^2 + j \frac{f}{Q f_{res}}\right)} \times \left(j \frac{f}{f_{ref}}\right)^{\frac{a}{\ln 10}}$$

*Sign* = Polarity

*b* = Temperature coefficient

*T* = Temperature

*T<sub>ref</sub>* = Reference temperature

*f* = Frequency

*f<sub>hp</sub>* = High-pass cut-off frequency

*f<sub>lp</sub>* = Low-pass cut-off frequency

*f<sub>res</sub>* = Resonance frequency

*f<sub>ref</sub>* = Reference frequency

*Q* = Quality factor

*a* = Amplitude slope/decade

Combining this equation with the amplitude sensitivity *S<sub>ref</sub>* and *f<sub>ref</sub>* and *T<sub>ref</sub>* we have:

$$S(f, T) = S_{ref} \times \frac{S_{rel}(f, T)}{|S_{rel}(f_{ref}, T_{ref})|}$$

Implementation of this formula in either real-time data acquisition systems or in post-processing will support automatic update of amplitude and/or phase.

*Individually measured frequency response curves*

*Individual data for best-fit to measured frequency response*

*The direction of minimum transverse sensitivity is indicated on the calibration chart of each DeltaTron accelerometer.*

*The dynamic range of an accelerometer is the range over which its electrical output is directly proportional to the acceleration applied to its base.*

## Transverse Sensitivity

All piezoelectric accelerometers are slightly sensitive to acceleration perpendicular to their main sensitivity axis. This transverse sensitivity is measured during factory calibration using 30 Hz and 100 ms<sup>-2</sup> excitation, and is given as a percentage of the corresponding main axis sensitivity.

## Transverse Resonance Frequency

Typical values for the transverse resonance frequency are obtained by mounting an accelerometer on the side of a steel cube attached to a Calibration Exciter Type 4290.

## Dynamic Range

### Upper Limit

In general, the smaller the accelerometer, the higher the vibration level at which it can be used. The upper limit depends on the type of vibration to which the accelerometer is subjected and is determined by the pre-stressing of the piezoelectric elements as well as by the mechanical strength of the element.

The acceleration ranges given in the specifications are determined by the measuring limits of the integral preamplifiers. For transporting and handling, the maximum non-destructive shock is given.

When short duration transient signals are measured, care must be taken to avoid ringing effects due to the high-frequency resonance of the accelerometer. As a general rule, the duration of a half sine shock pulse should be greater than  $5/f_R$  for an amplitude error of less than 10%, where  $f_R$  is the mounted resonance frequency of the accelerometer.

### Lower Limit

The lower limit is imposed by the noise level of the integral preamplifier, which has been constructed to give very low noise levels, and by the environment in which the measurements are made.

## Electrical Impedance

All DeltaTron accelerometers have integral preamplifiers and can be regarded as voltage sources. The output impedance is typically less than 100 Ω. With a supply current of >4 mA, the output impedance is typically less than <30 Ω.

---

## Environment

---

*A discussion of the effect of environmental influences, can be found in the Brüel & Kjær handbook "Piezoelectric Accelerometers and Vibration Preamplifiers".*

*The procedure for measuring temperature transient sensitivity is also described in the handbook.*

## Temperature

DeltaTron accelerometers have an operating temperature range of -50°C to +125°C. Throughout this range, the sensitivity of the accelerometers has a small temperature dependence, details of which are given on the individual calibration charts (see Fig. 2).

## Temperature Transients

All piezoelectric accelerometers have slight sensitivity to temperature fluctuations. This effect may be significant when low frequency, low level acceleration is being measured.

## Humidity

DeltaTron accelerometers have all-welded titanium housings to give them a high resistance to the majority of corrosive agents found in industry. The low impedance of the preamplifier gives it a low sensitivity to humidity on the output terminal and allows the accelerometers to be used without protection in conditions where there is a small amount of condensation.

Where heavy condensation is encountered, the use of moisture impervious cables and sealing will permit operation. Suitable sealants are Dow Corning's RTV 738 or similar compounds.

## Sound Pressure

The acoustic sensitivity is low, and can be neglected for most vibration measurements. The vibration signal from the structure under test is normally much greater than the signal due to acoustic sensitivity.

Acoustic sensitivity is specified as an equivalent acceleration caused by a 154 dB sound pressure level in the frequency range 2 Hz to 100 Hz, but the specified value is normally valid outside this range.

## Electromagnetic Compatibility (EMC)

The accelerometers comply with Standards EN 50081-1 and EN 50082-2 for emission and immunity, respectively.

## Base Strain

Base strain sensitivity, which is minimised by the Delta Shear construction, is specified in  $\text{ms}^{-2}/\mu\epsilon$ .

*Susceptibility of DeltaTron accelerometers to radio-frequency electromagnetic radiation is also low.*

*Base strains can be introduced into an accelerometer by distortion of the surface to which it is attached.*

---

## Connecting Cables

---

*For direct connection to DeltaTron accelerometers, miniature, double-screened, low-noise, single-core, coaxial cables are available.*

Type 4397A requires cables with an M3 connector while Types 4398A and 4399A require cables with 10–32 UNF connectors. See Optional and Additional Accessories, the Transducer & Conditioning Catalogue (BF 0189) and Sound & Vibration Catalogue (BF 0201) for additional cable lengths and connectors.

Note, however, that for many non-critical applications, lower quality cables or twisted pairs can be used. However, when such cables are used, the EMC certification is not valid.

Details of the accelerometer connections and recommended plug clearances are given in the section entitled Accelerometer Dimensions.

### *Maximum Cable Length*

The maximum output voltage of a DeltaTron accelerometer depends on the supply current at which it is operating, and on the capacitive load due to the connecting cable.

Fig. 3 shows typical curves for maximum output levels with supply currents of 2 and 20 mA (for distortion  $\leq 1\%$ ).

The maximum cable length in metres is given by:

$$L = 75000 \times \frac{I_s}{f \times V_o \times C_m}$$

where

$I_s$  = supply current [mA]

$f$  = frequency [kHz]

$V_o$  = output voltage [ $V_{\text{peak}}$ ]

$C_m$  = cable capacitance [pF/m]

If the supply current is less than 4 mA, the power consumption of the built-in preamplifier becomes significant and this formula cannot be applied.

Fig. 3 Typical curves for maximum output level of DeltaTron accelerometers, showing maximum capacitive load over the recommended current supply range

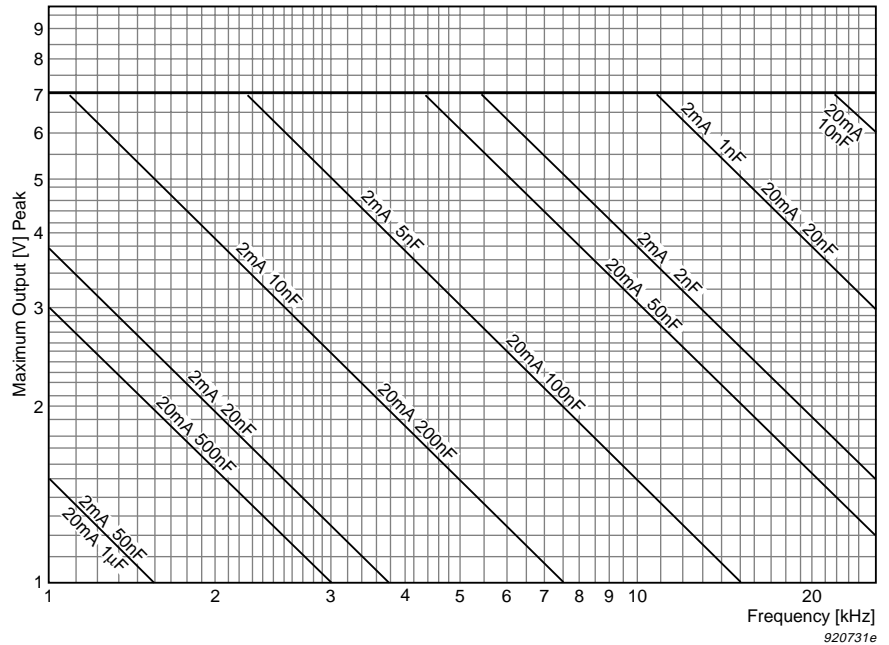

## Mounting

Brüel & Kjær accelerometers can be mounted with their main sensitivity axis aligned in any direction.

### Recommended Mounting Technique

Fig. 4 Recommended mounting technique for Type 4397A using Steel Stud YS8321 and for Types 4398A/-9A using Steel Stud YG0150

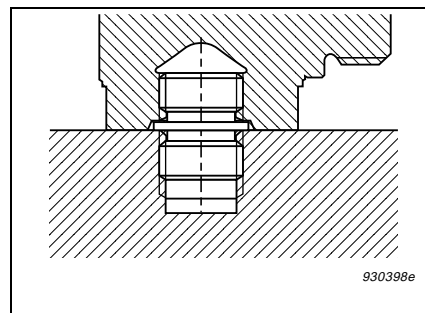

Fig. 4 shows the recommended mounting method for these accelerometers. The accelerometers are screwed onto a clean metal surface using a threaded steel stud and meet the requirements specified in Fig. 5.



# Calibration

*All Brüel & Kjær accelerometers are thoroughly checked and examined at each stage of manufacture and assembly. Each accelerometer undergoes an extensive calibration procedure and artificial ageing process to ensure completely predictable performance and stable operation. Accurate numerical details of the calibration are reported on the calibration chart supplied with each transducer (see Fig. 2).*

## Factory Calibration

At Brüel & Kjær, piezoelectric accelerometers are calibrated by back-to-back comparison with a primary reference standard accelerometer which is regularly calibrated by laser interferometry at the Danish Primary Laboratory of Acoustics and by both the American National Institute of Standards and Technology and the German Physikalisch-Technische Bundesanstalt. The overall accuracy of the back-to-back comparison is  $\pm 2\%$  with a 99.9% confidence level ( $\pm 1.6\%$  for a 99% confidence level), while for the interferometry method the accuracy is better than  $\pm 0.6\%$  with a 99% confidence level.

## Subsequent Calibration

Regular calibration of accelerometers helps maintain confidence in the measurements taken and indicates whether accelerometers have been damaged. Brüel & Kjær offers a factory Standard Calibration as a re-calibration service including a new calibration chart (see Ordering Information). Brüel & Kjær manufactures a range of equipment for frequency response, sensitivity and system calibrations, details of which are available in separate Product Data.

## Compliance with Standards

	CE-mark indicates compliance with: EMC Directive and Low Voltage Directive. C-Tick mark indicates compliance with the EMC requirements of Australia and New Zealand
<b>Safety</b>	EN 61010-1 and IEC 61010-1: Safety requirements for electrical equipment for measurement, control and laboratory use. UL 3111-1: Standard for Safety – Electrical measuring and test equipment
<b>EMC Emission</b>	EN 50081-1: Generic emission standard. Part 1: Residential, commercial and light industry. EN 50081-2: Generic emission standard. Part 2: Industrial environment. CISPR 22: Radio disturbance characteristics of information technology equipment. Class B Limits. FCC Rules, Part 15: Complies with the limits for a Class B digital device.
<b>EMC Immunity</b>	EN 50082-1: Generic immunity standard. Part 1: Residential, commercial and light industry. EN 50082-2: Generic immunity standard. Part 2: Industrial environment. <b>Note 1:</b> The above is guaranteed using optional accessories listed in this Product Data sheet only. <b>Note 2:</b> The above is guaranteed only when the AC output is not in use.
<b>Temperature</b>	IEC 68-2-1 & IEC 68-2-2: Environmental Testing. Cold and Dry Heat. Operating Temperature: $-50$ to $+125^{\circ}\text{C}$ ( $-58$ to $+257^{\circ}\text{F}$ )
<b>Humidity</b>	IEC 68-2-3: Damp Heat: 90% RH (non-condensing at $40^{\circ}\text{C}$ ( $104^{\circ}\text{F}$ ))



## Accessories Included

Part Number		4397A	4398A	4399A
YS8321	Steel Stud M3/M3 (UA 1221 is a set of 25 of these studs)	x		
YG0150	Steel Stud 10–32 UNF/10–32 UNF		x	x
BC0325	Individual Calibration Chart	x		
BC0326	Individual Calibration Chart		x	
BC0327	Individual Calibration Chart			x

## Optional Accessories

Part Number		4397A	4398A	4399A
AO 1381*	Teflon Low-noise Cable, double screened AC0104 (∅ 1.6 mm). Fitted with one 10–32 UNF and one M3 connector. Length 1.2 m	x		
AO 1382*	Teflon Low-noise Cable, double screened AC0104 (∅ 1.6 mm). Fitted with two 10–32 UNF connectors. Length 1.2 m		x	x
JJ0032	Extension Connector for cables fitted with 10–32 UNF connectors	x	x	x
JP0145	10–32 UNF to BNC Adaptor	x	x	x
YS8321	Steel Stud M3/M3 (UA 1221 is a set of 25 of these studs)	x		
YQ2003	Steel Stud M3, 5 mm long	x		
YG0150	Steel Stud 10–32 UNF/10–32 UNF		x	x
YQ2960	10–32 UNF Threaded Steel Stud. Length 0.5 in.		x	x
YQ2962	10–32 UNF Threaded Steel Stud. Length 0.3 in.		x	x
YM0414	10–32 UNF Nut		x	x
QA0041	Tap for M3 Thread	x		
QA0029	Tap for 10–32 UNF Thread		x	x
DB0757	Cement Stud M3. Diameter 8 mm	x		
DB0756	Cement Stud 10–32 UNF. Diameter 14 mm		x	x
QA0042	Hexagonal Key for M3 studs	x		
QA0013	Hexagonal Key for 10–32 UNF studs		x	x
YJ0216	Beeswax for mounting	x	x	x
UA0642	Mounting Magnet with 10–32 UNF stud		x	x
YO0073	25 × Adhesive Mounting Discs. Diameter 5.5 mm	x		
QS0007	Tube of Cyanoacrylate Adhesive	x	x	x
UA1218	Standard Accessory Set	x		
UA1219	Standard Accessory Set		x	x
WB1372	DeltaTron Power Supply	x	x	x
ZG0328	Power Supply Adaptor	x	x	x

\*The EMC certification is only valid for AO 1381 and AO 1382

## Additional Accessories

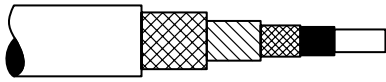

### Free-length Cables

**AC 0005** Teflon Insulated Super Low-noise Cable  
**AC 0066** Teflon Insulated Low-noise Cable  
**AC 0104** Teflon Insulated Double Screened Low-noise Cable (illustrated)  
**AC 0200** Reinforced double screened version of AC 0005  
**AC 0208** PVC Coated Cable  
 The EMC certification is only valid for AC 0104



### Accessories for Self-assembly Cables (only 10–32 UNF connector)

**UA 0130** Set of 25 Plugs JP 0012 for Cables AC 0104 and AC 0005  
**UA 0730** Set of 25 Plugs JP 0056 for Cable AC 0200. For mounting the plugs, the Assembly Tool QA 0035 is required



**UA 0553** Set of 5 electrically insulated 10–32 UNF Mechanical Filters UA 0559, plus a tommy bar for mounting  
**WA 0224** same as UA 0553 but for M3

### Cables with Connectors

a) M3/10–32 UNF  
**AO 0283** Cable AC 0205, 1.2 m  
**AO 0339** Cable AC 0066, 1.2 m  
 b) 10–32 UNF/10–32 UNF  
**AO 0038** Cable AC 0005, 1.2 m  
**AO 0122** Cable AC 0200, 3 m  
**AO 0463** Cable AC 0208, 1.2 m  
**AO 1419** Cable AC 0066, 1.2 m  
 c) **AO 0531** Cable AC 0208, 5 m



**JP 0145** 10–32 UNF to BNC adaptor for connection of cables with Miniature Coaxial Plugs JP 0012 and JP 0056

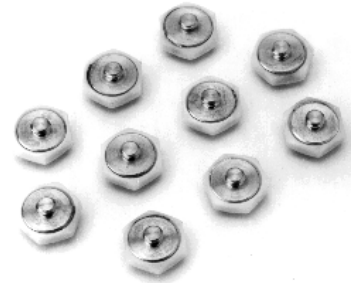

**UA 1192** Set of 10 Insulating Studs 10–32 UNF/10–32 UA 1215  
**UA 1193** Set of 10 Insulating Studs M3/M3 UA 1216

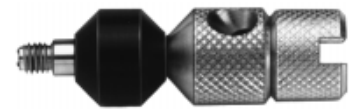

**QA 0035** Assembly Tool for mounting miniature plugs on accelerometer cables



**UA 0643** Set of 5 10–32 UNF Mounting Magnets UA 0642. Includes PTFE self-adhesive discs for electrical insulation



**UA 0186** Set of 25 Extension Connectors JJ 0032 for miniature cables with Plugs JP 0012 or JP 0056

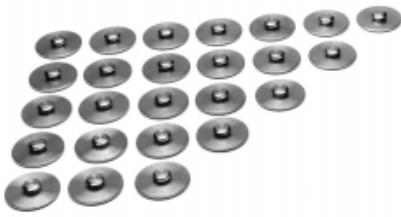

**UA 0866** Set of 25 10-32 UNF Cement Studs DB 0756  
**UA 0867** Set of 25 M3 Cement Studs DB 0757



**UA 1221** Set of 25 Steel Studs M3/M3 with Flange YS 8321





**UA 0125** Set of 10 Insulating Studs YP 0150, 10 Steel Studs YQ 2960, 10 Nuts YM 0414, 10 Mica Washers YO 0534 plus 10-32 UNF tap and hexagonal key for 10-32 UNF studs

## Accelerometer Dimensions

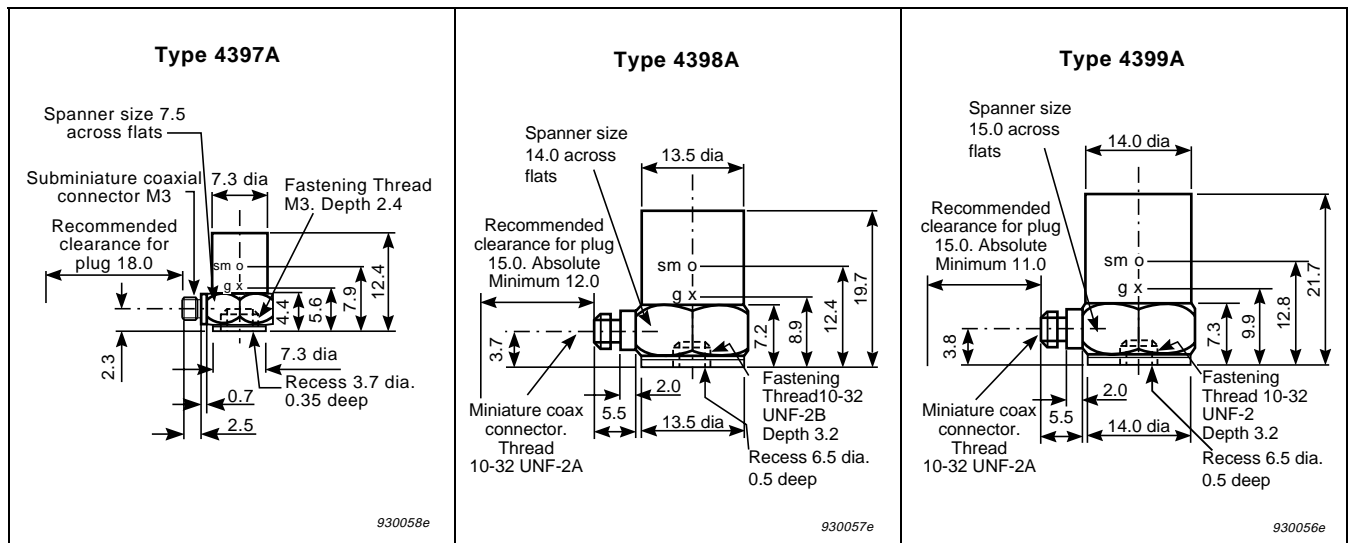
Fig. 7 Accelerometer dimensions – shown full scale, all dimensions in mm



# Specifications

		Type 4397A	Type 4398A	Type 4399A
				
<b>Dynamic</b>				
Mounted Resonance Frequency, typical	kHz	53	38	29
Transverse Resonance Frequency, typical	kHz	17	14	10
Sensitivity (axial) at 159.2 Hz, 100 ms <sup>-2</sup> (10.2g), 25°C (77°F), 4 mA	mV/ms <sup>-2</sup> (g)	1.00 (9.807) ± 2 %		10.0 (98.07) ± 2 %
Measuring Range (peak), typical	temperature <100°C (212°F)	±7500 (765)		±750 (76)
	temperature <125°C (257°F)	±5000 (510)		±500 (51)
Frequency Range (±10%), typical.*	Hz	1 to 25000	0.3 to 18000	1 to 14000
Maximum Transverse Response	%	< 4		

\*Note: The frequency range from 5 Hz to 10 kHz is measured individually and shown on the calibration chart supplied. The expanded uncertainty 5 Hz to 4 kHz: 1.0%, 4 kHz to 7 kHz: 1.4% and 7 kHz to 10 kHz: 2% is determined in accordance with EAL-RZ. A coverage factor  $k = 2$  is used. This corresponds to a coverage probability of 95% for a normal distribution.

## Electrical

Constant Current Supply	temperature <100°C (212°F)	mA	+2 to +20		
	temperature <125°C (257°F)	mA	+2 to +10	+2 to +20	
Supply Voltage, unloaded	for full specification	V DC	+24 to +30		
	minimum (reduced specification)	V DC	+18		
Output Impedance		Ω	< 100		
Bias Voltage	at 25°C (77°F), 4 mA	V	12 ± 0.5		
	full temperature and current range	V	8 to 15		
Residual Noise, typical	from 1 to 22000 Hz	μV	<25	<15	<40
	equivalent acceleration	ms <sup>-2</sup> (g)	<0.025 (0.0026)	<0.015 (0.0015)	<0.004 (0.0004)
Polarity (acceleration directed from base into body)			Positive		
Recovery time from Overload (2×maximum level)		μs	<20	<15	<25

## Environmental

Base Strain Sensitivity, typical		ms <sup>-2</sup> (g)/με	0.005 (0.0005)	0.02 (0.002)	0.01 (0.001)
Maximum Non-destructive Shock (peak)	Axial	ms <sup>-2</sup> (g)	100000 (10200)	50000 (5100)	20000 (2040)
	Transverse	ms <sup>-2</sup> (g)	50000 (5100)	20000 (2040)	10000 (1020)
Temperature Range		°C (°F)	-50 to +125 (-58 to +257)		
Humidity			Welded, sealed		
Temperature Transient Sensitivity, typical		ms <sup>-2</sup> /°C (g/°F)	2 (0.1)	0.2 (0.01)	0.1 (0.006)
Magnetic Sensitivity (50 Hz, 0.038T), typical		ms <sup>-2</sup> (g)/T	10 (1)	20 (2)	5 (0.5)
Acoustic Sensitivity (154 dB SPL), typical		ms <sup>-2</sup> (g)	0.01 (0.001)	0.005 (0.0005)	0.002 (0.0002)

## Physical

Weight		gram (oz.)	2.4 (0.09)	11.8 (0.42)	17.1 (0.60)
Height		mm (in)	12.4 (0.49)	19.7 (0.77)	21.7 (0.85)
Spanner Size		mm (in)	7.5 (0.30)	14.0 (0.55)	15.0 (0.59)
Construction			Delta Shear		
Piezoelectric Material			PZ 23		
Case Material	Titanium		ASTM Gr. 2		
Connector	Coaxial		M3 miniature	10–32 UNF	
Mounting Thread	Tapped centre hole		M3	10–32 UNF	
Mounting Torque		Nm (lb.in)	0.2 to 0.6 (1.8 to 5.3)	0.5 to 3.5 (4.4 to 31)	

# Ordering Information

Type 4397A	Miniature DeltaTron Accelerometer	4397-CFF	Re-calibration
Types 4398A, 4399A	DeltaTron Accelerometers	4398-CFF	Re-calibration
See tables for Included, Optional and Additional Accessories		4399-CFF	Re-calibration

---

Brüel & Kjær reserves the right to change specifications and accessories without notice