

# NEMESIS 5100G2

AUTOMATIC HARDNESS TESTER

UNIVERSAL | ROCKWELL, VICKERS, KNOOP & BRINELL



# NEMESIS 5100G2

## Cutting edge technology, and beyond...

The second generation of the NEMESIS 5100, the G2, Rockwell / Vickers / Knoop and Brinell hardness tester provides exceptional performance, designed to match the most demanding user tasks. The NEMESIS 5100G2 contains a revolutionary force application range and renewed optical system.

The all new 9 position tool changer (turret) accommodates a wide range of indenters, indenter actuators with load cells, objectives, a cross-laser positioning system and a load cell supported touch probe. It also provides a base to the 18 megapixel full color measurement camera and 18 megapixel full color overview camera with variable field of view, motorized zoom and auto focus system.



## HARDNESS SCALES



**VICKERS**  
+ HVD (HVT)

10gf - 150kgf



**KNOOP**

10gf - 5kgf



**BRINELL**

+ HBD (HBT) with AI

1kgf - 3000kgf



**ROCKWELL**

3kgf - 150kgf



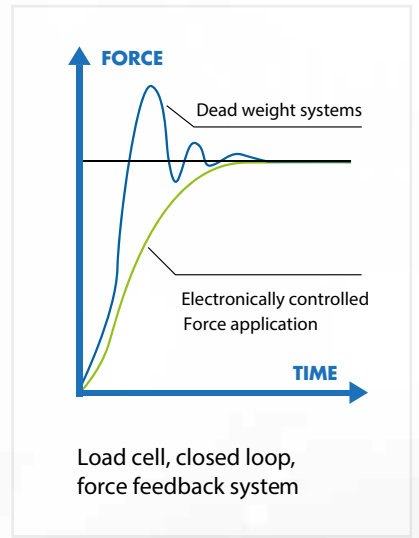

# SUPPORTED

## METHODS & SCALES



# 9-POSITION TOOL CHANGER

## Full configuration freedom...

Newly developed 9 position state-of-the-art tool changer. From "turret" to tool changer because the 5100G2 turret offers more than purely holding lenses and indenters. The high-speed rotating mechanism is prepared for future modular plug & play tooling development. The tool changer is fully configurable.

Either 8 indenters or 8 objectives, or any combination, a laser positioning system and touch probe are installed as standard. The standard (removable) skirt protects tooling from damage.

### LOW FORCE INDENTER POSITION

The low force indenter position is a complex assembly containing multi load cells providing a force range for Vickers, Knoop and Brinell from 10gf up to 187.5kgf. Multiple assemblies can be installed on the tool changer.

### CROSS LASER & TOUCH PROBE

The cross laser & touch probe can be simultaneously used in the 9th position without loss of tooling positions. Multi touch probes available, with or without cross laser.

### MEDIUM FORCE INDENTER SEATS

This indenter seat allows hardness testing ranging from option A: 200gf up to 45kgf for Vickers, Knoop, Brinell or option B: 1kgf up to 250kgf for Vickers, Knoop Brinell and Rockwell. Multiple indenter seats can be installed on the tool changer.

### HIGH FORCE INDENTER SEAT

This indenter seat allows hardness testing ranging from 5kgf up to 3000kgf for Vickers, Knoop and Brinell. Multiple indenter seats can be installed on the tool changer.

### COLLISION DETECTION SYSTEM

The collision detection system prevents tooling damage by early detecting obstructions in the test-path. The tool changer is continuously monitored during all movement processes and instantaneously stops and retracts if an obstruction is detected.



## DOCKING STATION

The NEMESIS 5100G2 has a iSMART™ docking station for the quick mounting of workpiece platforms. The docking station allows a wide variety of test tables, anvils, manual XY stages and the new wireless iSMART™ motorized CNC X-Y stages to dock within seconds. In this way, the user can create the most ideal circumstances for his particular workpiece.

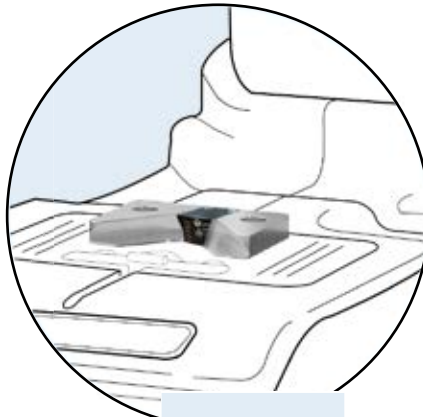

iSMART™

### DOCKING STATION

The docking station is a new INNOVATEST standard. It can be found on an increasing number of hardness testers. This means that you can change your fixtures, stages, anvils and even the wireless iSMART™ motorized CNC X-Y stage between the various machines in your possession. No need to duplicate expensive tooling for different machines.

The iSMART™ docking station provides communication identification and power supply to various mounted accessories.

iSMART™ technology offers unlimited configuration freedom and safety for your tester. Creating a hardness testing system that can be configured to any requirements with standard or bespoke options, fitting a wide range of stage accessories and fixtures.

Automatic Stage recognition provides overload protection and damage to accessories.

## iSMART™ MANUAL | DIGITAL X-Y STAGES *A variety of manual and digital stages are available from the accessories list.*

**Manual iSMART™ stage**  
UN-XYSTAGE/120  
Surface: 100 x 100mm  
Travel: 25 x 25mm



**Digital micrometer\***  
IMP-DIGMIC  
25 mm travel



**Digital control unit\***  
BM-08-0059  
50 mm travel

**Digital control unit\***  
BM-08-0058  
25 mm travel

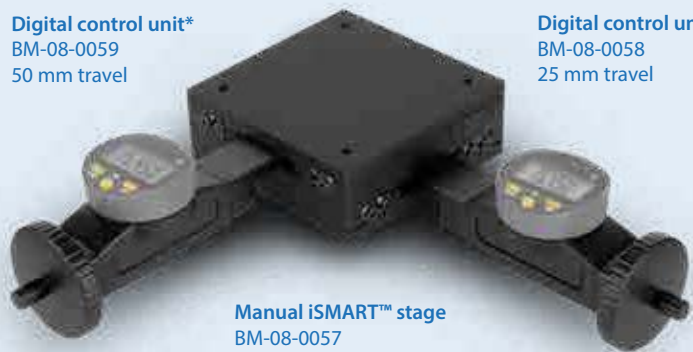

**Manual iSMART™ stage**  
BM-08-0057  
Surface: 150 x 150mm  
Travel: 50 x 50mm

*\*Can be used on a variety of manual stages, see page 31 (Stage/anvils)*

## The purpose of software is to control complexity...

*Software that optimizes user comfort with a wide range of standard functionality such as auto measurement, auto-focus, reporting, test program storage, and many more.*

For the more advanced users, for whom the standard applications would not be sufficient, IMPRESSIONS™ 4 has an unmatched level of optional “apps” that can be installed as plugins, later, at any moment. During the purchase of your tester, decide on what you need at that moment. Widen your options at any moment by a simple e-mail and a few mouse clicks, to install optional functionality. As easy or simpler than installing an app on your mobile phone.

# POWERED BY IMPRESSIONS v4

## Next gen workflow & tester control...

Just buy a software release ticket, and your tester has added functionality, regardless where it is located. A revolutionary system taking care of all your needs.

In this way we keep the learning curve, the process to work efficiently with our software limited to the level of “need to have” and “need to know”. The proportion of installed and activated software never needs to be more than your requirements.

On the higher end, IMPRESSIONS 4 connects flawlessly with quality control systems such as QDAS, exports files in CVS, XML or other formats and if your requirement is not standard, our team of engineers will efficiently find ways to handle your data properly. Bespoke solutions such as connectivity to robotic systems are standard solutions for INNOVATEST™.

Unique to IMPRESSIONS™ 4 is a choice for screen size and position. Whether you wish your interface to be in portrait mode or landscape, all functionality is supported in both positions. For table top solutions like testers in laboratories, users often opt for landscape screen(s).



# TIME REDUCING SOFTWARE SOLUTIONS...

## 1 PATTERN EDITOR

The IMPRESSIONS™ pattern editor allows the user to create any number of test patterns with a large number of variable settings. Create test patterns with great precision and freedom. Verify the settings in the preview mode. Drag & drop patterns from one test sample to another sample. Live vision technique over zoom overview camera, no image stitching required.

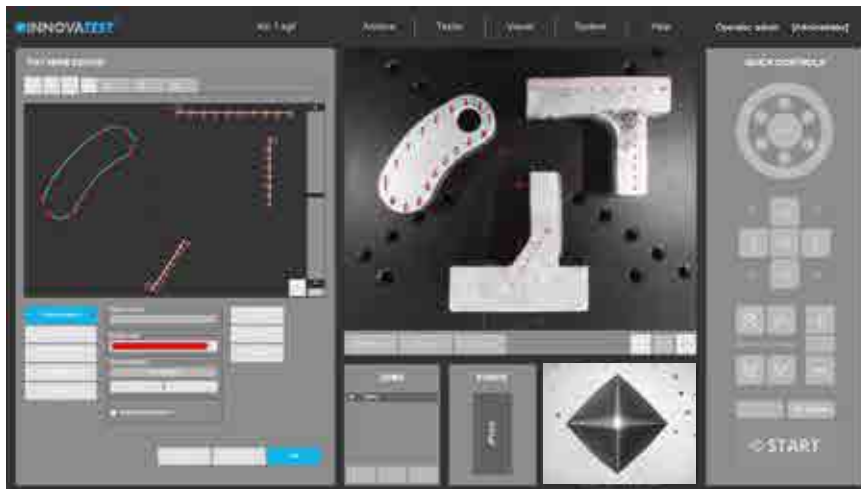

Combine different patterns and even different test forces in one program, and run them fully automatically. All test points can be identified individually or to customer specifications. The label is shown in the test result list and in the test results overview and in the results print out. An important function for sample analyses at the end of a test and in the future for review of previous tests.

## 2 CHD, SHD, NHD

How do you increase throughput in your lab? Make the most common testing design as easy to set up as possible to perform automatically and still adhere to the applicable standards. CHD/SHD/NHD testing can be started directly from the surface view or from the overview. Additional core points of hardness can be defined separately for NHD measurements.



The distances of test points are automatically set to a minimum distance, following the standard, to assure correct testing is conducted. Time saving test mode “complete all indentations – then evaluate” and “auto-stop” to complete test series as soon as the lower hardness limit has been reached. Report Generator is enhanced with reporting features for this application.



## 5 EDGE DETECTION

Technology that automatically or at a mouse click recognizes the edge of your sample. This helps to determine and fix the desired starting position for CHD or other pattern testing jobs.

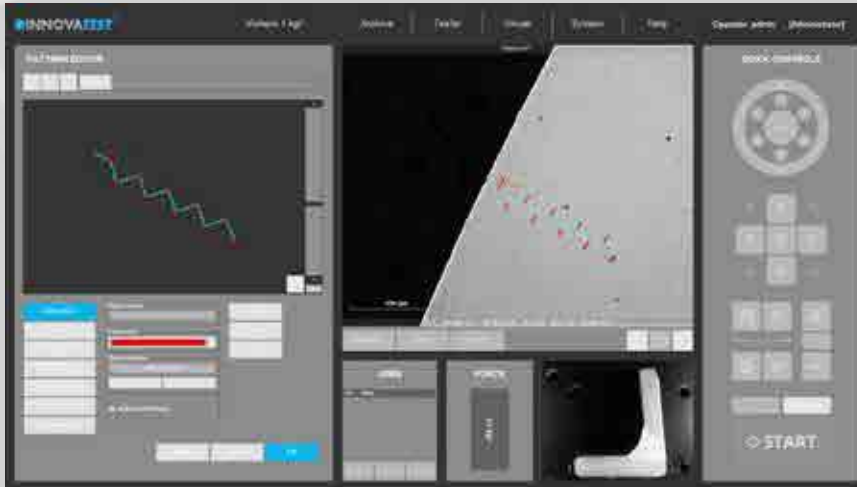

## 6 AUTOMATIC CONTOUR SCANNING

This application scans the entire outline (or partial) area of a sample. The function can be used with an objective by using the overview zoom camera for high speed scanning. The system scans the entire outline defined and stores all relevant data in the test program.



Subsequently, a limitless number of test points can be inserted into the scanned image, or be set at selected distances (offset), relative to the edge. This advanced feature enables the hardness testing procedure to be performed c. An excellent featured combined with 2D or 3D hardness mapping, also known as "plane hardness chart".



## 9 Kic CRACK MEASUREMENT

For those requiring more in depth knowledge on materials behavior, wishing to study material fracture and fatigue, crack growth can be predicted and measured by using the Kic application.



The software supports Kic crack detection under load with customized Kic result reporting. By way of one or both methods, Palmqvist or Median / Radial, fracture toughness is now a repeatable and reproducible test across multiple operators.

## 10 SNAPSHOT FUNCTION



This handy function in IMPRESSIONS™ allows you to make screen captures of the viewing area by way of objective view and/or Overview camera. It gives the opportunity to store such images with comments or to paste them into the report generator for further processing.

# MONITORING

Our world is going through processes that have influence on climate and environment. More often we see extreme heat, extreme cold and periods of extreme rain. To assure that such disturbances of nature do not coincidentally effect your measuring or testing results, we have prepared our machines to climate change and forces of nature.

## 13 VIBRATION & EARTH QUAKE MONITORING



The integrated high precision accelerometer electronics continuously monitor your tester's stability environment. While the tester has vibration isolators (machine dampers) installation environment is often not ideal. Think of heavy traffic, loaded fork lift trucks, excentre presses or other equipment making shop floor installation a base of trouble.

For certain countries/area's in the world where light earthquakes are so common that they are hardly noticed, the vibration monitoring system will give a warning message and stop the hardness testing process to avoid incorrect readings.

## 14 TEMPERATURE & HUMIDITY MONITORING



Extreme high or low temperatures might not only effect the hardness readings of your machine (think of installation in extremely warm countries or nearby furnaces) extreme humidity might even damage the sensitive electronics.

# METALLOSCOPE™

# METALLOGRAPHY

# SOFTWARE

**The objectives on the 5100G2 make the hardness tester into an excellent highly automated metallographic microscope. Metallographic studies are of key importance in the manufacturing process of metals and steel, in the aerospace and automotive industry, in mechanical engineering, construction and in the manufacturing of a vast number of industrial and consumer products.**

Microscopy is an indispensable feature of every metallographic lab, whether you investigate damages, develop novel alloy materials or perform quality control to ensure the purity of steel. The measurement of certain parameters such as volume fraction, coating thickness and grain size is specified in strict standards and norms.

Metallography is used to investigate metals from copper and titanium to iron, steel and alloys of every description. These investigations can now be performed quantitatively and reliably using the INNOVATEST Metalloscope™ 1 software module, running on most of our higher-end hardness testing machines\*. \*(features of Metalloscope™ 1 software depend on the particular tester model).

The microstructure of metals has a significant influence on properties such as strength and corrosion resistance. Therefore, a detailed investigation of the microstructure with the help of microscopy is central to metallographical disciplines as well as many industrial applications.

## GRAIN SIZE



### **Grain size;**

The grain size index can be calculated in various 1 or 2 dimensional way; using a 1-dimensional method (from the number of grain intercepts per mm) or a 2-dimensional method (from the number of grains per mm<sup>2</sup>). Line profile: 1-dimensional grain size index calculation by counting the number of grain intercepts on a line. Hexagonal grid: 2-dimensional grain size index calculation using a superimposed hexagonal grid or single grains calculation by counting the number of grains in a specific part of the image (blue box).

# AUTOMATIC IMAGE EVALUATION



## AUTO FOCUS

Fast & precise, observe how IMPRESSIONS™ finds focus from a large distance, as far as the travel of the Z-axis allows. Algorithms used for close distance autofocusing set new standards in AF speed.



## AUTOMATIC MEASUREMENT

Manual positioning of filar lines is no longer required. IMPRESSIONS™ refined measurement algorithms detect indents even on very poor or scratched surfaces and measure the relevant indent dimensions according to standards. Stay in control by switching to manual measure mode and have the option of adjusting measurements by touching the screen or using the mouse. Filar lines can be colored to give the best contrast against the specimen's surface. To assure that measurements meet relevant standards on symmetry, enable the automatic indent check. All hardness values can be converted to other scales according to ISO 18265, ISO 50150, ASTM E140.

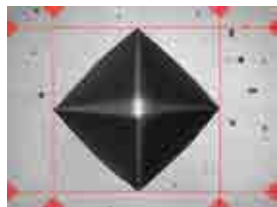

## ILLUMINATION SETTINGS

IMPRESSIONS™ software automatic illumination system adapts to the correct illumination regardless of the sample surface quality, wherever on the sample, independent from material (steel, carbide, coated or ceramic). Contrast, Brightness and program, can be set automatically for each measurement or controlled manually. Sharpness can be stored with the pre-determined test.

Too bright



OK

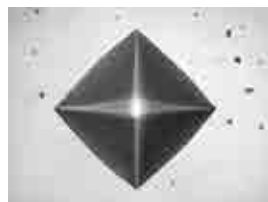

Too dark



Irregular surface



Regular surface



Poor surface

Complex, refined algorithms ensure reproducible measurements on different materials and even on scratched and damaged surfaces.



# NEMESIS 5100G2

## STEP 1: Select machine type

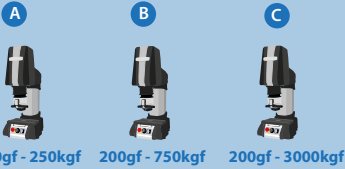

## STEP 2: Additional force range

**OPTION 1** 10gf - 200gf

**OPTION 2** 250kgf - 750kgf

## STEP 3: Indenter seats

<p><b>1 Laser &amp; touch probe</b></p> <p><b>A</b> <input checked="" type="checkbox"/> Cross laser</p> <p><b>B</b> <input checked="" type="checkbox"/> Touch probe</p> <p><b>C</b> <input checked="" type="checkbox"/> Touch probe laser</p> <p><input checked="" type="checkbox"/> = Standard included</p>	<p><b>2 Indenter seats</b></p> <p><b>A</b>  10gf - (62.5kgf) (187.5kgf)</p> <p><b>B</b>  200gf - 62.5kgf</p> <p><b>C</b>  1kgf - 250kgf</p> <p><b>D</b>  3kgf - (750kgf) (3000kgf)</p>
--	--

## STEP 4: Indenters

**3 Indenters**

**A** **Rockwell**

**B** **Brinell**

**C** **Vickers**

**D** **Knoop**

## STEP 5: Optical

**4 Overview camera**



**5 Objectives**

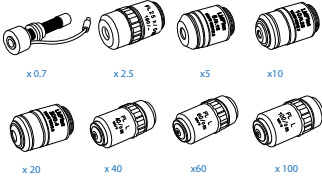

**6 Ringlights**



## STEP 6: Stages/Anvils

**7 Stages**



**8 Anvils**



## STEP 7: Sample holders

**10 Sample holders**

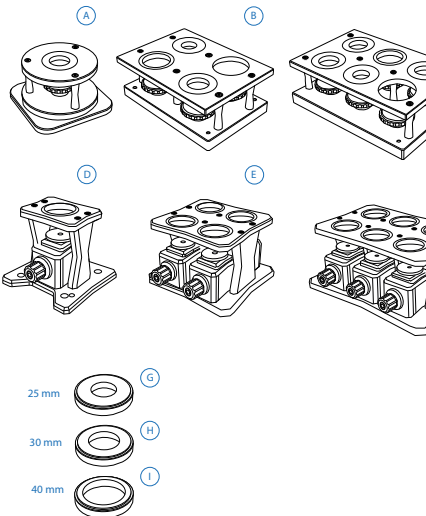

25 mm

30 mm

40 mm

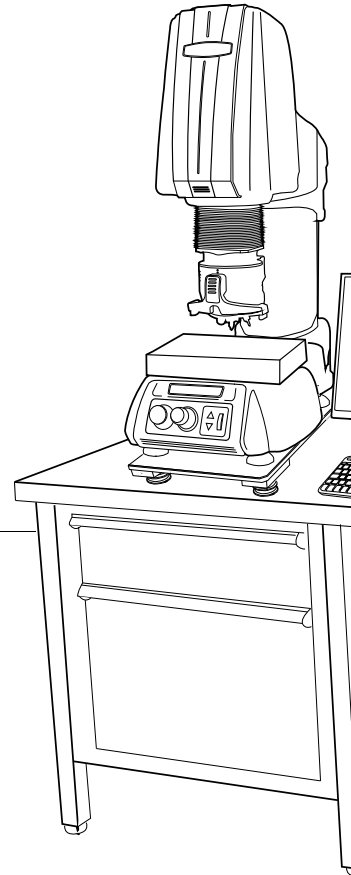

# ORDER DETAILS

## NEMESIS 5100G2



NEMESIS 5100G2/A Universal hardness tester, 200gf - 250kgf	NEMESIS 5100G2/A	
NEMESIS 5100G2/B Universal hardness tester, 200gf - 750kgf	NEMESIS 5100G2/B	
NEMESIS 5100G2/C Universal hardness tester, 200gf - 3000kgf	NEMESIS 5100G2/C	
<b>Option 1:</b> Force range extension 10gf - 200gf	F5100G2O1	
<b>Option 2:</b> Force range extension 250kgf - 750kgf, for 5100G2/A only	F5100G2O2	
Plug & Play prepared, calibration, sea & airworthy packing in "non coniferous wood" material	P&PSEAPACK130	

## ACCESSORIES

STEP 3		Indenter seats					
1	Laser & touch probe	(A)	Cross laser & touch probe base	SA-05-0027	STANDARD		
		(B)	Touch probe laser based, closed	SA-10-0036	STANDARD		
		(C)	Touch probe laser based, open	SA-10-0045	STANDARD		
2	Indenter seats	(A)	Indenter seat 3mm, 10gf - (62.5 kgf) (187.5kgf)	SA-10-0030			
		(B)	Indenter seat 6.35mm, 200gf - 62.5kgf	SA-10-0035			
		(C)	Indenter seat 6.35mm, 1kgf - 250kgf	SA-10-0034			
		(D)	Indenter seat 6.35mm, 3kgf - (750kgf) (3000kgf)	SA-10-0033			
			Indenter seat adjustment base, mounting set (1 for each SA-0030, 33, 34 & 35)	SA-10-0031			
			Fixed indenter seat base, mounting set (min. 1 required)	SA-10-0032			
STEP 4		Indenters					
3	Rockwell	(A)	Rockwell C Diamond Indenter, ISO & ASTM certified	IN/6005			
			Rockwell Ball Indenter 1/16". Includes 1 carbide ball, ISO & ASTM certified	IN/7506			
			Rockwell Ball Indenter 1/8". Includes 1 carbide ball, ISO & ASTM certified	IN/7606			
			Rockwell Ball Indenter 1/4". Includes 1 carbide ball, ISO & ASTM certified	IN/7706			
			Rockwell Ball Indenter 1/2". Includes 1 carbide ball, ISO & ASTM certified	IN/7806			
	Brinell	(B)	Brinell Indenter 1mm. Includes 1 carbide ball. Ø6.35mm. ISO & ASTM certified	IN/7000			
			Brinell Indenter 1mm. Includes 1 carbide ball. Ø3mm. ISO & ASTM certified	IN/7001			
			Brinell Indenter 2.5mm. Includes 1 carbide ball. Ø6.35mm. ISO & ASTM certified	IN/7005			
			Brinell Indenter 2.5mm. Includes 1 carbide ball. Ø3mm. ISO & ASTM certified	IN/7006			
			Brinell Indenter 5mm. Includes 1 carbide ball. Ø6.35mm. ISO & ASTM certified	IN/7010			
			Brinell Indenter 5mm. Includes 1 carbide ball. Ø3mm. ISO & ASTM certified	IN/7011			
			Brinell Indenter 10mm. Includes 1 carbide ball. Ø6.35mm. ISO & ASTM certified	IN/7015			
		Vickers	(C)	Macro Vickers Indenter Ø6.35mm, ISO & ASTM certified	IN/8010		
			Micro Vickers Indenter Ø3mm, ISO & ASTM certified	IN/8105			
	Knoop		(D)	Micro Knoop Indenter Ø3mm, ISO & ASTM certified	IN/8205		
		Macro Knoop Indenter Ø6.35mm, ISO & ASTM certified	IN/8220				
STEP 5							
4	Optical						
			5	Overview camera	Overview / Full view zoom camera + software functionality, field of view 57x60mm up to 225x180mm, Includes overview lights	CE-22-0148	
					Objectives	0.7x Objective for Brinell	AS9000-0.7OBJ
			2.5x Long Working Distance objective	ASSUN-OBJ2.5X			
			5x Long Working Distance objective	ASSUN-OBJ5X			
			10x Long Working Distance objective	ASSUN-OBJ10X			

			Motorized CNC X-Y stage, 357x208mm, total load up to 400Kgf max Displacement: 220x120mm, resolution 0.001mm, repeatability +/- 0.003mm	UN-XY572212TT	
			Motorized CNC X-Y stage, 337X238mm, total load up to 400Kgf max. Displacement: 200x150mm, resolution 0.001mm, repeatability +/- 0.003mm	UN-XY902015	
			Motorized CNC X-Y stage, 437x238mm, total load up to 450Kgf max. Displacement: 300x150mm, resolution 0.001mm, repeatability +/- 0.003mm	UN-XY903015	
			Motorized CNC X-Y stage, 630x238mm, total load up to 450Kgf max Displacement: 400x150mm, resolution 0.001mm, repeatability +/-0.003mm	UN-XY904015	
			Motorized CNC X-Y stage, 410X280mm, total load up to 4000Kgf max. Displacement: 200x150mm, resolution 0.001mm, repeatability +/- 0.008mm	UN-XY932015	
			Motorized CNC X-Y stage, 510x280mm, total load up to 4000Kgf max. Displacement: 300x150mm, resolution 0.001mm, repeatability +/- 0.008mm	UN-XY933015	
			Motorized CNC X-Y stage, 630x238mm, total load up to 4000Kgf max. Displacement: 400x150mm, resolution 0.001mm, repeatability +/- 0.008mm	UN-XY934015	
	<i>Cable sets, mounting &amp; Connectivity for motorized stage</i>		Dove tail mounting plate, for UN motorized stages	CM-08-0033	
			Cable set for connecting CNC stage to embedded driver (1 set for 2-axis) 105cm	UN-XY2CABLENBS	
8	Anvils	A	Flat anvil 60mm	AS3000-19-04	
		B	Flat anvil 80mm	UN-TESTTABLE/002	
		C	Spot anvil 5mm	UN-ANVIL/010	
		D	Spot anvil 10mm	UN-ANVIL/011	
		E	Cylindrical V anvil 6-80mm	UN-CVANVIL680	
		F	Cylindrical V anvil 50-200mm	UN-CVANVIL50200	
		G	V block with bracket 40x40x50mm (LxBxH)	UN-VBLOCK404050	
		H	Steel, cross type, (X) V-block 60x120x100mm 8-90mm pair	UN-CROSSBLOCK01	
		I	V-anvil ø40mm 6-60mm	UN-ANVIL/005	
		J	V-anvil ø63mm 10-100mm	UN-ANVIL/006	
		K	V-Anvil ø80mm 3.3-20mm	UN-ANVIL/040	
		L	V-Anvil ø80mm 12-80mm	UN-ANVIL/045	
		M	V-Anvil ø80mm 20-140mm	UN-ANVIL/050	
			Test table 100x100mm, V groove 20mm wide, 10mm deep	UN-TESTTABLE/040	
		N	Small V-Anvil 3-20mm requires base plate (Requires Manual/Autom. X-Y stage)	UN-ANVILSV/105	
		O	Large V-Anvil 20-75mm requires base plate (Requires Manual/Autom. X-Y stage)	UN-ANVILLV/106	
		P	Base plate for V-anvils, UN-ANVILSV/105 & UN-ANVILLV/106	UN-VANVILBASEPL	
		Q	Extra long V-Anvil (Ø10 - Ø100)	CM-08-0186	
	<i>Clamping, locking &amp; fixing adapters</i>		Quick change anvil base (required for mounting testing tables, anvils)	AS5000-450	
			Lock flange	AS9000-21-01	
<b>STEP 7</b>	<b>Sample holders</b>				
10	Sample holders	A	1 position sample holder, for 1 embedded sample, diameter 50mm or 2"	UN-ESH1	
		B	4 position sample holder, for max. 4 embedded samples, diameter 50mm or 2"	UN-ESH4	
		C	6 position sample holder, for max. 6 embedded samples, diameter 50mm or 2"	UN-ESH6	
		D	1 position sample holder, for 1 embedded sample, diameter 50mm or 2" with front operation elevator knob	BM-08-0052	

		ISO898-1 screw thread measurement of (de)-carbonized part. Requires UN-CSCAN	UN-ISO898/1	
		ISO-2702 tap screw thread measurement	UN-ISO2702	
		User level management	UN-LEVMAN	<b>STANDARD</b>
		CHD, SHD, NHD configurator & graphic interface for analogue and digital micro meter stage only (not including full pattern editor)	UN-MCHD	
		CHD, SHD, NHD configurator & graphic interface requires: indent pattern configurator (TESTPAT01)	UN-PATCHD	
		Q-DAS Certified connectivity protocol	UN-QDAS	
		Advanced 3-axis communication protocol for robotic systems	UN-REMC	
		ISO bullets casings pattern configurator and reporting system	UN-SHELLCONF	
		ISO 9015 Weld pattern configurator (automatic weld pattern configurator), requires overview camera or AS9000-0.7OBJ	UN-WELDPAT	
		Vibration, temperature & humidity monitoring	UN-VIBCLC	
		Artificial Intelligence Deep Learning Brinell module	UN-AIDLB01	<b>STANDARD</b>
		Barcode & QR data mapping software	UN-SCANFLOW	
		Metalloscope™ Metallogy software pack	UN-MSCPV1	
	Connectivity plus	Powerfull external intel core i7 pc, with 16gb ram, and 512gb ssd drive Windows 10 pre-installed including wiring and integration with tester.	UN-SYSPCIMP01	
		Bluetooth connectivity	UN-BTADAPT	
		Utility software; Import test results in MS applications like Excel	UN-SW/905	
		USB to USB null modem cable 2.5M	BE-99-0025	
		Wireless system Keyboard & wireless mouse	UN-SKBSET	<b>STANDARD</b>
		Virtual joystick, on screen		<b>STANDARD</b>
	<b>Additional items</b>			
	Machine stands	<b>A</b> Cabinet test table with drawer for hardness testers 71x75x80cm	UN-STAND/960	
		<b>B</b> Cabinet test table with drawer for hardness testers 150x75x80cm	UN-STAND/965	
		Seaworthy packing box for 950/960	PACK/100	
		Seaworthy packing box for 965	PACK/200	
	Vibration isolation stage	Passive vibration isolation stage, broad spectrum	UN-AVS-300	
	Printer	Laser Printer	UN-PRINT	
	Projector	On request, any brand of choice	UN-PROJECTOR	
	<b>ISO 17025 UKAS</b> ISO / ASTM Calibration	BRINELL direct and indirect calibration & certification, traceable, in compliance with ISO & ASTM, NADCAP. Includes direct force and indirect verification report (block readings), report, flat fee for selected common scales, per scale.	CCERTUKAS/1B	
	<b>ISO 17025 UKAS</b> ISO / ASTM Calibration	VICKERS direct and indirect calibration & certification, traceable, in compliance with ISO & ASTM, NADCAP. Includes direct force and indirect verification report (block readings), report, flat fee for selected common scales, per scale.	CCERTUKAS//1V	
	<b>ISO 17025 UKAS</b> ISO / ASTM Calibration	KNOOP direct and indirect calibration & certification, traceable, in compliance with ISO & ASTM, NADCAP. Includes direct force and indirect verification report (block readings), report, flat fee for selected common scales, per scale.	CCERTUKAS/1K	
	<b>ISO 17025 UKAS</b> ISO / ASTM Calibration	ROCKWELL direct and indirect calibration & certification, traceable, in compliance with ISO & ASTM, NADCAP. Includes direct force and indirect verification report (block readings), report, flat fee for selected common scales, per scale.	CCERTUKAS/1R	
	Cover	Machine cover 600x700x1000mm	UN-COVER5	
	Joystick	3-axis joystick, with fine adjustment and dynamic axis control	UN-JOYSTICK1	



## STAGES/ANVILS

### Stages



IMP-DIGMIC



BM-08-0057  
BM-08-0058  
BM-08-0059



### Wired stages

UN-XY571212TT	UN-XY904015
UN-XY571712TT	UN-XY932015
UN-XY572212TT	UN-XY933015
UN-XY902015	UN-XY934015
UN-XY903015	

### iSMART™ stages

MA-XY7575S	MA-XY3412S
MA-XY1212S	MA-XY2015S
MA-XY2212S	MA-XY3015S
	MA-XY4015S

### Anvils



AS3000-19-04



UN-TESTTABLE/002



UN-ANVIL/010



UN-ANVIL/011



UN-CVANVIL680  
UN-CVANVIL50200



UN-VBLOCK404050



UN-CROSSBLOCK01



UN-ANVIL/005



UN-ANVIL/006



UN-ANVIL/040



UN-ANVIL/045



UN-ANVIL/050



UN-ANVILSV/105



UN-ANVILSV/106



UN-VANVILBASEPL



CM-08-0186

## SAMPLE HOLDERS

### Sample holders - Regular model



A



B



C

UN-ESH1  
UN-ESH4  
UN-ESH6



G

UN-ESHI25



H

UN-ESHI30



I

UN-ESHI40

### Sample holders - Front operation



D

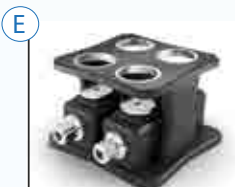

E



F

BM-08-0052  
BM-08-0054  
BM-08-0056



J

UN-ESHI1



K

UN-ESHI125



L

UN-ESHI15

# SPECIFICATIONS

## HARDNESS SCALES

	<b>ROCKWELL</b>  <b>EN-ISO 6508</b> <b>ASTM E-18</b> <b>JIS Z 2245</b>	Regular Rockwell scales; Pre Load 10kgf, Main Load 60kgf   100kgf   150kgf A   B   C   D   E   F   G   H   K   L   M   P   R   S   V Superficial Rockwell scales; Pre Load 3kgf, Main Load 15kgf   30kgf   45kgf 15N   30N   45N   15T   30T   45T   15W   30W   45W   15X   30X   45X   15Y   30Y   45Y
	<b>VICKERS</b>  <b>ISO 6507</b> <b>ASTM E384, E92</b> <b>JIS B 7725</b>	HV0.010, HV0.015, HV0.020, HV0.025, HV0.050, HV0.1, HV0.2, HV0.3, HV0.5, HV1, HV2, HV2.5, HV3, HV4, HV5, HV10, HV20, HV25, HV30, HV40, HV50, HV60, HV100, HV120, HV150
	<b>Kic Fracture toughness</b>	All Vickers forces & scales
	<b>KNOOP</b>  <b>ISO 4545</b> <b>ASTM E92</b> <b>JIS Z 2251</b>	HK0.01, HK0.02, HK0.025, HK0.05, HK0.1, HK0.2, HK0.3, HK0.5, HK1, HK2, HK5
	<b>BRINELL</b>  <b>ISO 6506,</b> <b>ASTM E10</b> <b>JIS Z 2243</b>	HBW1/1   HBW1/1.25   HBW1/2.5   HBW1/5   HBW1/10   HBW1/30 HBW2.5/6.25   HBW 2.5/7.8125   HBW2.5/15.625   HBW2.5/31.25   HBW2.5/62.5   HBW2.5/187.5 HBW5/25   HBW5/31.25   HBW5/62.5   HBW5/125   HBW5/250   HBW5/750 HBW10/100   HBW10/125   HBW10/250   HBW10/500   HBW10/1000   HBW10/1500   HBW10/3000
	<b>HVD (HVT)</b>  <b>VDI/VDE 2616-1</b>	HV5   HV10   HV20   HV30   HV50   HV100   HV120
	<b>HBD (HBT)</b>  <b>VDI/VDE 2616-1</b>	HBW1/5   HBW1/10   HBW1/30   HBW2.5/6.25   HBW2.5/15.625   HBW2.5/31.25   HBW2.5/62.5   HBW2.5/187.5   HBW5/25   HBW5/125   HBW5/250   HBW5/750   HBW10/100   HBW10/500   HBW10/1000   HBW10/1500   HBW10/3000
	<b>PLASTIC</b>  <b>ISO 2039</b>	49,03 N, 132,9 N, 357,9 N, 961 N
	<b>CARBON</b>	HR 2,5/7   HR 5/7   HR 5/15   HR 5/20   HR 5/40   HR 5/60   HR 5/100   HR 5/150   HR 10/20 HR 10/40   HR 10/60   HR10/100   HR 10/150
	<b>CONVERSIONS</b>	Conversion to other hardness scales according to ASTM E140, ISO 18265, GB/T 1172

## TEST FORCE

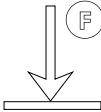
	<b>Force application</b>	Servo drive, precision gearbox, motion & torque feedback system Multi-load cell, closed loop, force feedback
	<b>Test forces</b>	10gf – 3000kgf
	<b>Force range per model</b>	<b>NEMESIS 5100G2 A</b> 200gf - 250kgf <b>NEMESIS 5100G2 B</b> 200gf - 750kgf <b>NEMESIS 5100G2 C</b> 200gf - 3000kgf
	<b>Optional force ranges</b>	<b>OPTION 1</b> 10gf - 200gf <b>OPTION 2</b> 250kg - 250kgf
	<b>Test force tolerance</b>	< 0.25% for test force 100gf to 3000kgf < 0.5% for test force below 100gf
	<b>Dwell time settings</b>	Default 10 seconds, user defined. Up to 999 seconds

# BATCH

# PRODUCTION



## Select your required test force range...

10gf	200gf	<b>NEMESIS 5100G2 / A</b>	250kgf	3000kgf
10gf	200gf	<b>NEMESIS 5100G2 / B</b>	750kgf	3000kgf
10gf	200gf	<b>NEMESIS 5100 G2 / C</b>		3000kgf

## Upgrade now, later, at any moment, during order or online!

<b>OPTION 1</b>	10gf - 200gf	<b>OPTION 2</b>	250kgf - 750kgf
-----------------	--------------	-----------------	-----------------

# HIGHLIGHTS

- 1 Multi load cell, closed loop system, custom test force configuration
- 2 Force range from 10gf up to 3000kgf
- 3 Force upgrade available also years after first installation
- 4 9 position tool changer (turret) with visual LED process indicators
- 5 Free to configure 8 objectives, 8 indenters, cross laser, touch probe, optional tools
- 6 Hardness tester & Metallurgy microscope with optional Metalloscope™ software
- 7 18 megapixel full color measurement camera, bright white LED TTL illumination
- 8 18 megapixel full color sample image & stage overview camera, anti-glare filter, motorized zoom for variable field of view and autofocus at any field of view
- 9 Adjustable & rotatable dual LED workspace illumination
- 10 iSMART™ docking station for CNC X-Y motorized or manual stage solutions
- 11 7 options for CNC X-Y high precision motorized iSMART™ stages (400kgf up to 4000kgf load)
- 12 Automatic workpiece height detection
- 13 Unique collision detection and test head retraction system
- 14 Integrated or External high performance, MS Windows based i7 system controller
- 15 IMPRESSIONS 4™ workflow and tester control system with 1 x 27" or 2 x 24" (touch) screens
- 16 Artificial Intelligence (AI) for enhanced Brinell readings
- 17 Top quality ABS replaceable body parts, no frame damage from falling objects



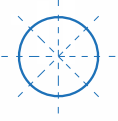

## ROCKWELL

EN-ISO 6508, ASTM E-18, JIS Z 2245

Regular Rockwell scales; Pre Load 10kgf, Main Load 60kgf | 100kgf | 150kgf

A B C D E F G H K L M P R S V

Superficial Rockwell scales; Pre Load 3kgf, Main Load 15kgf | 30kgf | 45kgf

15N 30N 45N 15T 30T 45T 15W 30W 45W 15X 30X 45X 15Y 30Y 45Y

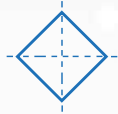

## VICKERS

DIN EN ISO 6507, ASTM E-92, ASTM E-384

HV0.010	HV0.015	HV0.020	HV0.025	HV0.050
HV0.1	HV0.2	HV0.3	HV0.5	HV1
HV2	HV2.5	HV3	HV4	HV5
HV10	HV20	HV25	HV30	HV40
HV50	HV60	HV100	HV120	HV150



## KNOOP

DIN EN ISO 4545, ASTM E-92, ASTM E-384

HK0.01	HK0.02	HK0.025	HK0.05	HK0.1
HK0.2	HK0.3	HK0.5	HK1	HK2
HK5				



## BRINELL

DIN EN ISO 6506, ASTM E-10

HBW1/1	HBW1/1.25	HBW1/2.5	HBW1/5	HBW1/10
HBW1/30	HBW2.5/6.25	HBW2.5/7.8125	HBW2.5/15.625	HBW2.5/31.25
HBW2.5/62.5	HBW2.5/187.5	HBW5/25	HBW 5/31.25	HBW 5/62.5
HBW5/125	HBW5/250	HBW5/750	HBW10/100	HBW10/125
HBW10/250	HBW10/500	HBW10/1000	HBW10/1500	HBW10/3000



## CONVERSIONS

DIN EN ISO 18265, DIN EN ISO 50150, ASTM E140



The LED bars on the front of the tool changer continuously inform you about the device status. The range of flash intervals and color codes (red, blue, green) indicate the process mode of the tester; **red**: automatic operation, (busy & hands off), **blue**: in single test procedure; or **green**: idle, ready for next task.

### CRYSTAL CLEAR™ RINGLIGHTS

Brinell ringlights optimized for each magnification in combination with Artificial Intelligence (AI see page 23).

### STAGE ILLUMINATION

Adjustable power LED banks provide excellent diffused stage illumination.

### PROTECTION SKIRT

The skirt mounted on the rotating centre of the tool changer protects each individually installed tool against accidental damage.

# MOTORIZED CNC X-Y STAGES

The new wireless (or wired) iSMART™ motorized CNC X-Y stages provide excellent specifications combined with maximum flexibility. This new technology allows you to purchase a standard machine to start with, add stages, change dimensions of motorized CNC stages according to new requirements later in the life of the tester and upgrade in just seconds!

**WIRELESS iSMART™ STAGES**



iSMART™ technology reduces possible down time on stage maintenance to seconds in case of calamities. While most automatic machines will be “out of service” if the stage is defective, a wireless iSMART™ stage can just be exchanged in seconds. No downtime!

There is a choice of 7 different type of iSMART™ stages (see table below) and if you need larger dimensions or different specifications for Custom Products, we can manufacture any possible stage to your requirements.

iSMART™ stages have onboard controllers and the EIS (electronic identification system) communicates with your hardness tester to create safety and assure no stage overload can take place.

The stages have pre-determined hole patterns on their surfaces. These patterns are in line with all INNOVATEST hardness testing stage accessories such as 1, 4, 6 or 12 position sample holders, vices and others.

**AVAILABLE DIMENSIONS**

Type	MA-XY7575S	MA-XY1212S	MA-XY2212S	MA-XY3412S	MA-XY2015S	MA-XY3015S	MA-XY4015S
Travel mm	75x75	120x120	220x120	340x120	200x150	300x150	400x150
Surface mm	215x160	260x205	360x205	490x224	410x265	510x265	560x265
Max load kg	400	400	400	400	4000	4000	4000

*Consult with our sales department for other dimensions with short lead times.*

**TECHNOLOGY HIGHLIGHTS**

- High speed positioning by motors and drivers for medical applications.
- Ball bearing spindles with overload protection clutches.
- Integrated ultra precise position reading electronics.
- Position accuracy 0.001mm, repeatability 0.0015mm.
- 7 different dimensions and travel options, see table above.
- Maximum load 400kg or 4000kg.
- Quick Change iSMART™ adapter, mount stage in seconds
- Wireless or wired connectivity.
- Replaceable, upgradeable, interchangeable.
- Matt black finish for maximum contrast with objective and overview camera's.

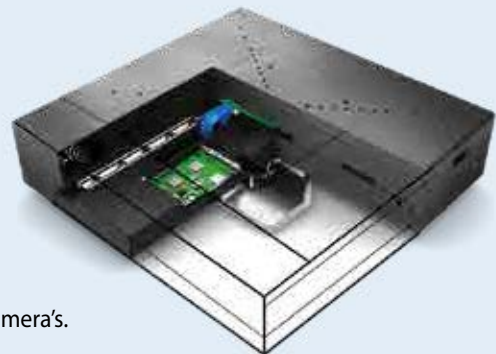



On the shopfloor the large landscape screens are often an unwanted component either requiring a table top or machine mounted bracket taking a lot of space and cables to deal with. IMPRESSIONS 4 leaves you the option to go for landscape or for portrait mode on a large selection of our machines.

For the NEMESIS 5100G2, INNOVATEST recommends the 27" industrial quality landscape screen operated by both touch as well as mouse and keyboard. One screen is standard included with the hardness tester, optional is the Dual view function, these are 2 x 24" industrial quality landscape screens. New applications are added to IMPRESSIONS™ on a regular basis; while INNOVATEST provides 10 years free updates, upgrades to more functionality or new additions can be purchased at any time.



### 3 WELD INSPECTION (ISO 9015)

This especially developed tool enables you to conduct hardness testing on welded parts or segments according to ISO standard. Setting up the pattern according to the requirements becomes "easy-to-do", due to pre-set test points in the different zones of the weld and automatic correlation between test points. The system will run a fully automatic test procedure and display and record the results accordingly. The Report Generator is enhanced with reporting features for this application.



### 4 HARDNESS OF SCREW THREAD DECARBONIZED ZONE (ISO898-1)

A specialized software tool of IMPRESSIONS™ allows you to set up and conduct fully automatic testing as per ISO898-1 for screw thread measurement of (de)-carbonized part.

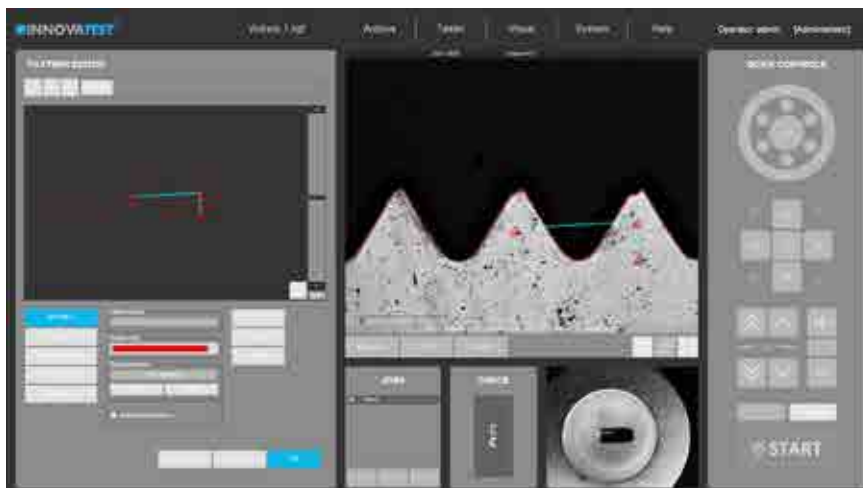

The Report Generator is enhanced with reporting features for this application.

## 7 2D HARDNESS CHART

The application „Plane hardness chart“, is also referred to as Color Mapping happens to be the perfect tool for securing the detail of the effective hardness distribution over the total sample cross section of heat treated samples. An important feature in material exploration, weld testing or in damage analysis.

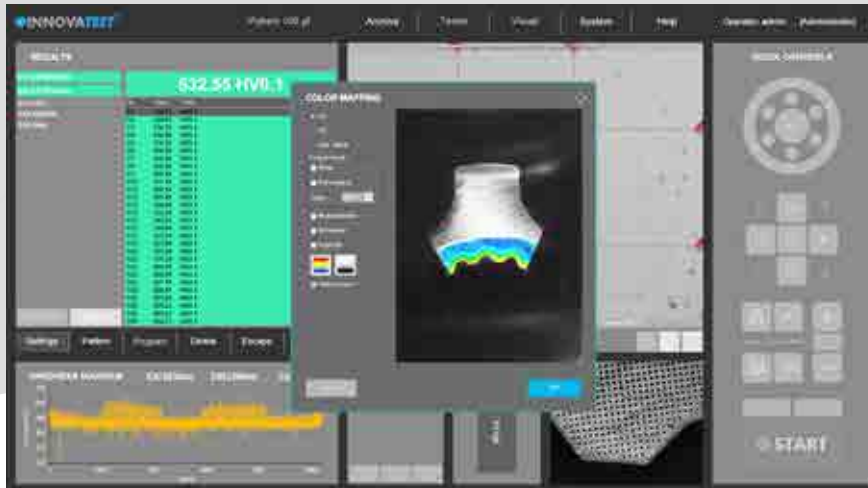

## 8 3D HARDNESS CHART

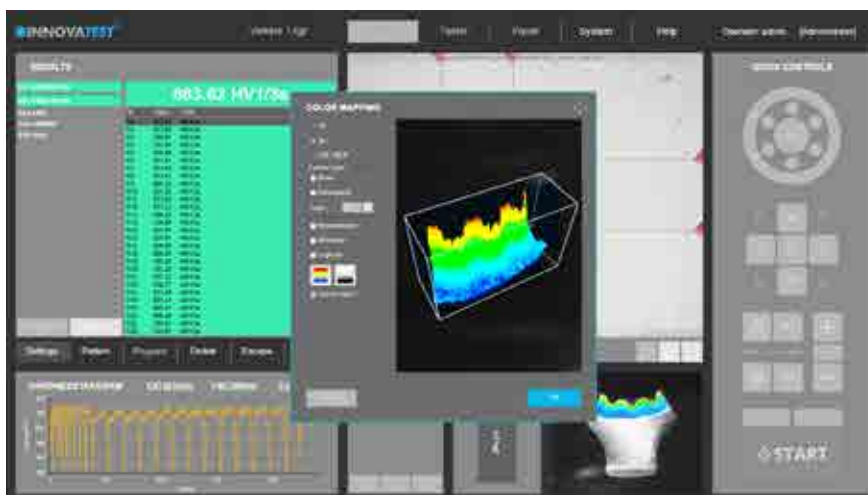

In addition to 2D graphic diagrams, the system can also automatically generate 3D diagrams. 2D and 3D hardness charts are included in one application.

## 11 USER DEFINED PROGRAMS

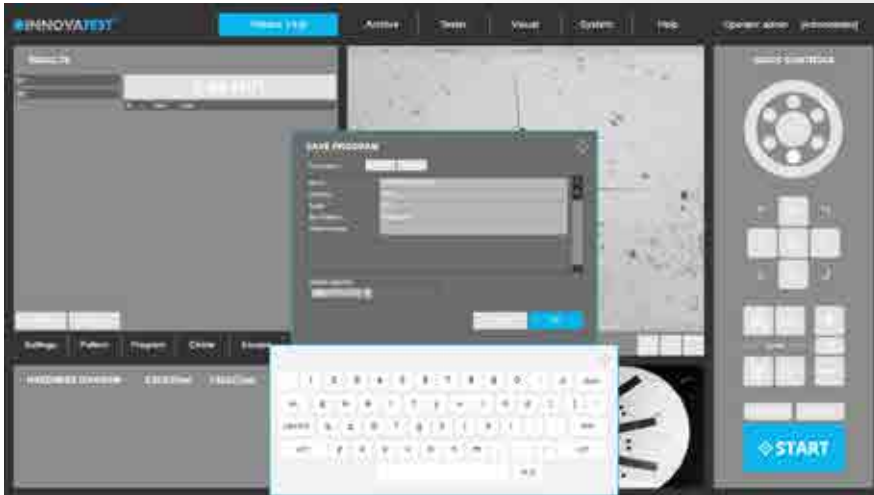

For repeating jobs, IMPRESSIONS™ utilizes the option of setting up and storing custom test programs. For each task, a “job” can be created. All application specific parameters, such as hardness scale, force, dwell-time, pattern, conversion and the report template are stored in the same program.

## 12 REPORT GENERATOR

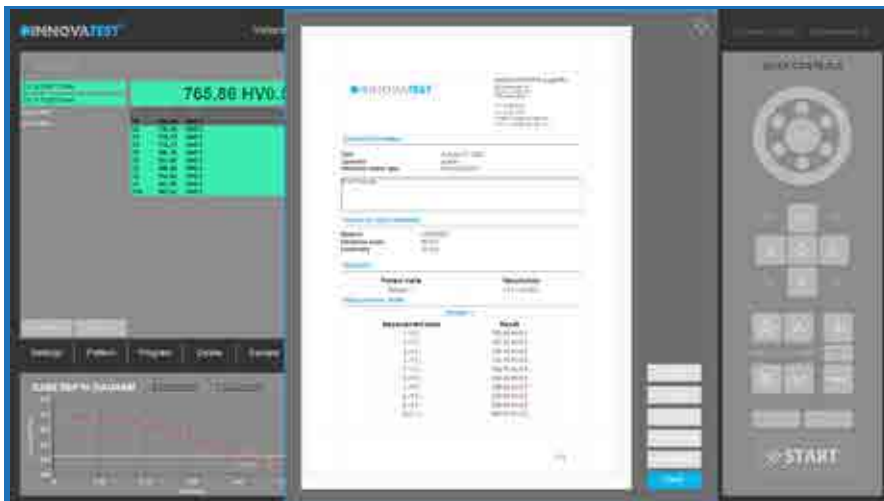

Imagine having a report created for you that includes: Your company name, address, contact information, labeled results related to patterns or sequential, pictures of your optical measurements, stitched images, notes section for each result or pictures, rendition of the pattern performed, overview picture of your pattern on your sample, full statistics, summary of your results, go no-go results, Pass or fail...

All this information or having the ability to only have what you need reported, we call this our Report Configurator. You decide how much or how little you report by PDF or laser printer. We even keep it simple by choosing export to CSV file, to a thumb drive or network file location. Data management at its best!

## BARCODE & QR SOLUTIONS

# IDENTIFICATION

- 15 The basic function of the barcode reader is to load data in to determined user fields. The BAR | QR code module of INNOVATEST connects the machine to a database or network environment loading samples and data.

Whether simply inserting header files (single or serial) or the complete integration of reading devices for the automatic selection of database templates, retrieving data from connected ERP or quality systems (optional) QR and barcode readers simplify complicated work procedures for the operator.



In the above application, a turbo part has been engraved with a QR code. Extra challenging was the fact that the QR code was engraved in a high polished part of the turbo shaft.

All data for the particular turbo part was fixed in the underlying QR code. The scanner loads all customer data in the hardness testing machine and assures that the testing outcome is included in the particular test report database, fully automatic.



## Hardness tester and metallurgical microscope.

Basic metals undergo specific treatment in order to prepare them for particular applications and to improve their characteristics, for example by adding alloying elements. In many cases, the microscopy investigation focusses on the correlation between the resulting microstructure and the material properties.

### VOLUME FRACTION

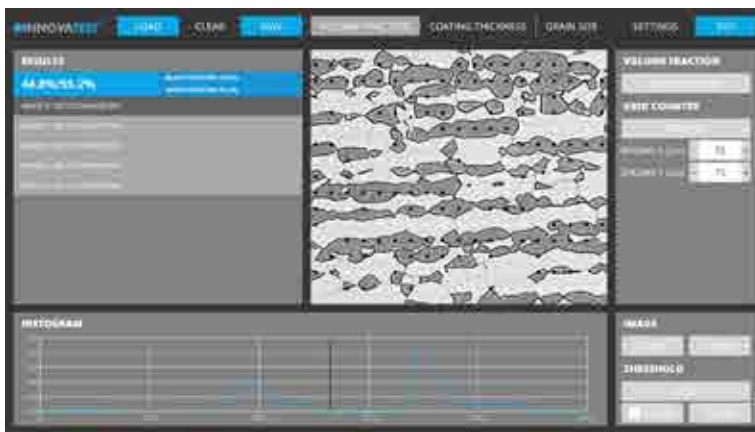

#### **Volume fraction:**

Various methods integrated; the example shows a sample consisting of ferrite (black material) and austenite (white material). Pixel counter: calculation based on histogram-guided image thresholding. Two automatic thresholding algorithms in addition to manual thresholding. Grid counter calculation using a superimposed grid. Each grid point can be assigned to the black material or white material. Initial values (black or white) are assigned automatically, but can be toggled manually. Grid positions are calculated by defining the number of grid points or the grid spacing.

### COATING THICKNESS

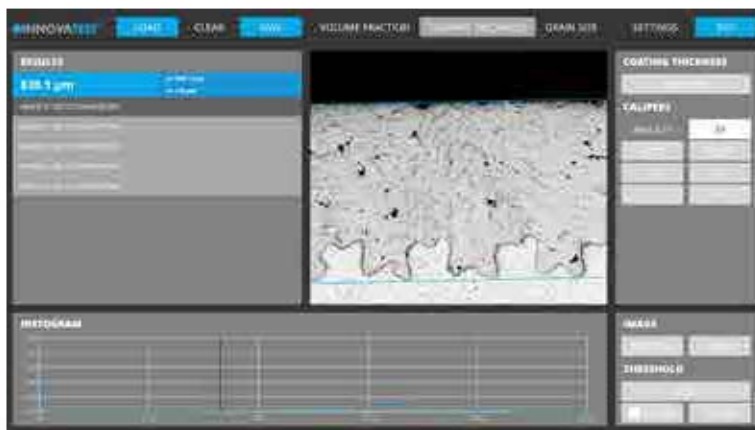

#### **Coating thickness:**

Calculate the thickness of a coating layer. This can be a single thickness or a mean thickness with standard deviation or a coating contour. Calculation using two parallel lines. The resulting coating thickness is the distance between these lines. Calipers can be rotated, automatic or manual. Coating contour: coating thickness calculation based on a number of measurement points. Contour edges are drawn semi-automatically and the number of measurement points can be selected by the user.

The NEMESIS 5100G2 is basically an upright, brightfield and darkfield microscope. Contrast methods of reflected light brightfield result are best suited to analyze the microstructures of etched surfaces. Recognizing grain boundaries, you can draw conclusions on grain sizes, phases and structural constituents. Impurities and structural constituents, such as graphite in cast iron, prior to etching are getting visible.

Reflected light darkfield shows up mechanical surface faults such as fracture sites, pores and inclusions as well as cracks, scratches and cavities. In combination with the NEMESIS 5100G2 automation, the system provides in maximum efficiency for both hardness testing and materials inspection.

# SUPERIOR ARTIFICIAL INTELLIGENCE (AI)

**We include an advanced physics development breakthrough in the image analyses of our Brinell capable hardness testing machines.**

The conventional image processing methods on hardness testing machines are fairly successful for clean images that present clear indentation boundaries. In practice, however, workpieces or samples often have rough surfaces that compromise the quality of the image processing which could potentially result in incorrect hardness values.

A human observer can easily find the indentation in both images and the exact boundaries of such indentation (see fig. 1). For a computer algorithm, finding the indentation in the right image is much more challenging due to the many gradients in this image (see fig. 2). Artificial intelligence can overcome this difficulty by training a complex computer neural network to “think” as a human observer.

The INNOVATEST Brinell AI model is trained in our research facility/R&D department using powerful supercomputers. The training phase optimizes millions and millions of weight factors in a neural network, to learn how an indent can look like, using a gradient descent approach. Weight factors have been optimized by a human observer and after optimum weigh factors where determined. Using the AI function on our hardness tester to detect new indentations is called “inference” and requires significantly less computing power. The AI model has been created.

The integrated Intel® Core™ i7 processor can easily handle this task which makes it possible to install and use the INNOVATEST Brinell AI module on the NEMESIS 5100G2 as well.

During inference , a new image (a new Brinell indent image) is entered in to the neural network with weights that where determined during training (see fig. 3).

The complex algorithm is capable to calculate a “mask” on its own, this mask is plotted on top of the indent image, exactly filling the indent and marking the edges that then can be easily detected by automatic image recognition system (see fig. 4).

This super advanced technology requires no special objectives and provides even indents with poor visibility, often the case with shallow indents in rough surface materials, to be perfectly detected and measured.

The system is far superior to special objectives and standard Brinell measuring systems.

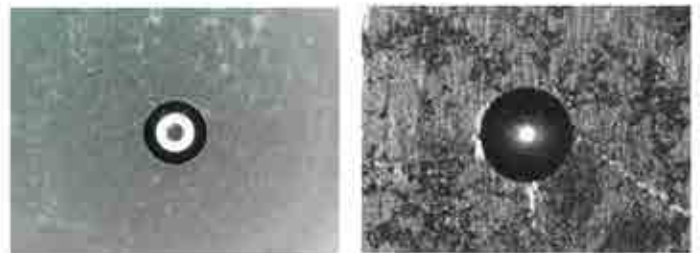

fig.1-2

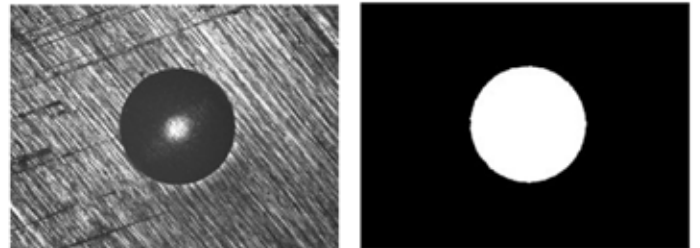

fig.3-4



# CONFIGURATION OPTIONS

Online configuration: [www.innovatest-europe.com/products/NEMESIS-5100G2](http://www.innovatest-europe.com/products/NEMESIS-5100G2)

\*Single or Dual Screen set-up

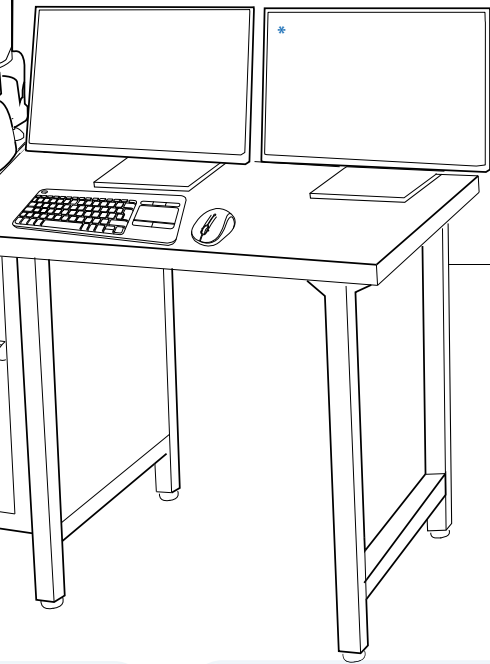

## STEP 8: Fixtures & Vices

### 9 Fixtures & Vices

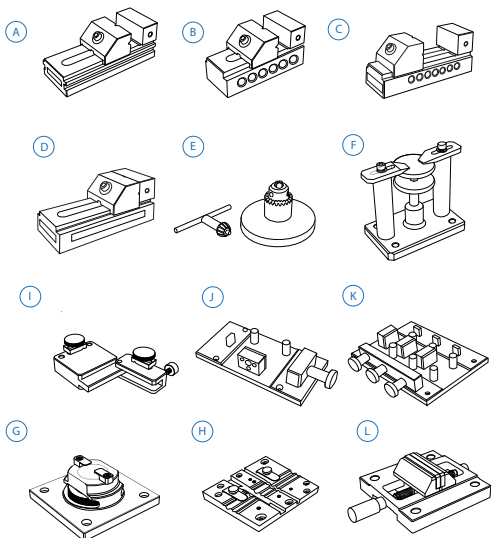

## STEP 9: Software



MANUAL ON-SCREEN MEASUREMENT



AUTOMATIC MEASUREMENT

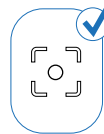

AUTOMATIC FOCUSING



REPORT GENERATOR



SNAPSHOT FUNCTION

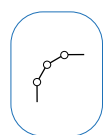

VIDEO OVERLAY PATTERN EDITOR

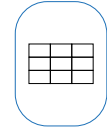
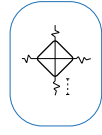
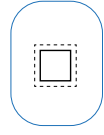

IMAGE STITCHING



KIC CRACK MEASUREMENT



AUTOMATIC CONTOUR SCANNING



2D / 3D HARDNESS CHART



DRAWING & MEASURING APPLICATION



DUALVIEW TECHNOLOGY



AUTOMATIC EDGE DETECTION



FORCE DEPTH/TIME DIAGRAM

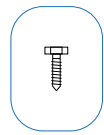

HARDNESS OF SCREW THREAD (ISO 898-1)

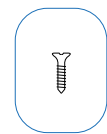

HARDNESS OF TAPPING SCREWS (ISO 2702)



USER LEVEL MANAGEMENT

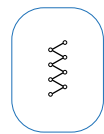

CHD, SHD, NHD CONFIGURATOR



Q-DAS

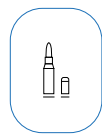

AMMUNITION TESTING PATTERN

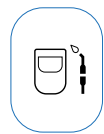

WELD INSPECTION (ISO 9015)

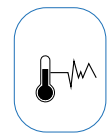

VIBRATION, TEMPERATURE & HUMIDITY MONITORING



AI SOFTWARE



BARCODE & QR SOLUTIONS



METALLOSCOPE SOFTWARE

✓ = Standard included

Not all accessories are displayed on this page. Full details can be found on the Order details page.

			20x Long Working Distance objective	ASSUN-OBJ20X	
			40x Long Working Distance objective	ASSUN-OBJ40X	
			60x Long Working Distance objective	ASSUN-OBJ60X	
			100x Long Working Distance objective	ASSUN-OBJ100X	
			Adjustable objective socket 2.5x – 100x (1x required for each objective)	SA-05-0025	
			Adjustable objective socket 0.7x ( required for 0.7 objective )	SA-05-0026	
6	Ringlights	A	Crystal™ Clear LED ring light, multi use for 0.7x objectives	SA-05-0020	
		B	Crystal™ Clear LED ring light, multi use for 2.5x objectives	SA-05-0021	
		C	Crystal™ Clear LED ring light, multi use for 5x objectives	SA-05-0022	
<b>STEP 6</b>	<b>Stages/Anvils</b>				
7	Stages	A	Manual X-Y stage with analogue metric micrometers, 180x160mm Displacement: 25x25mm, scale 0.01mm, max load 300kg	UN-TESTTABLE/030	
	<i>Clamping, locking &amp; fixing adapters</i>		Lock flange	UN-XYZ BUSH50	
			Mounting plate for lock flange	UN-XYZ30FP50-55	
			Quick change anvil base (required for mounting testing tables, anvils)	AS5000-450	
		B	Testing table flat ø200mm, screwfix	UN-TESTTABLE/010	
			Testing table flat ø235mm, screwfix	UN-TESTTABLE/012	
			Testing table Ø200mm (61 - 65HRC) requires lock flange	CM-08-0194	
		C	Manual X-Y stage with analogue metric micrometers, 100x100mm. Displacement: 25x25mm, scale 0.01mm, max load 100kg	UN-XYSTAGE-120	
		D	Large flat surface testing table 350x250mm, thickness 30mm with 2 T-slots, for large components	UN-TESTTABLE/015	
			Large flat surface testing table 450x350mm, thickness 35mm with 2 T-slots, for large components	UN-TESTTABLE/016	
		E	Digital micrometer, for manual X-Y stage, Displacement: 25mm, resolution 0.001mm	IMP-DIGMIC	
		F	Manual iSMART™ stage, 150x150mm, Displacement: 50x50mm	BM-08-0057	
			Digital control unit for Manual iSMART™ stage, 25mm travel	BM-08-0058	
			Digital control unit for Manual iSMART™ stage, 50mm travel	BM-08-0059	
		G	iSMART™ motorized CNC X-Y stage, 215x160mm, total load up to 400Kgf max. Displacement: 75x75mm, resolution 0.001mm, repeatability+/-0.015mm	MA-XY7575S	
			iSMART™ stage, 260x205mm, total load up to 400Kgf max. Displacement: 120x120mm, resolution 0.001mm, repeatability+/-0.015mm	MA-XY1212S	
			iSMART™ stage, 360x205mm, total load up to 400Kgf max. Displacement: 220x120mm, resolution 0.001mm, repeatability+/-0.015mm	MA-XY2212S	
			iSMART™ stage, 490x224mm, total load up to 400Kgf max. Displacement: 340x120mm, resolution 0.001mm, repeatability+/-0.015mm	MA-XY3412S	
			iSMART™ stage, 410x265mm, total load up to 4000Kgf max. Displacement: 200x150mm, resolution 0.001mm, repeatability+/-0.015mm	MA-XY2015S	
			iSMART™ stage, 510x265mm, total load up to 4000Kgf max. Displacement: 300x150mm, resolution 0.001mm, repeatability+/-0.015mm	MA-XY3015S	
			iSMART™ stage, 560x265mm, total load up to 4000Kgf max. Displacement: 400x150mm, resolution 0.001mm, repeatability+/-0.015mm	MA-XY4015S	
			Motorized CNC X-Y stage, 257x188mm, total load up to 400Kgf max Displacement: 120x120mm, resolution 0.001 mm, repeatability+/-0.003mm	UN-XY571212TT	
			Motorized CNC X-Y stage, 307x208mm, total load up to 400Kgf max Displacement: 170x120mm, resolution 0.001mm, repeatability+/-0.003mm	UN-XY571712TT	



		(E)	4 position sample holder, for max. 4 embedded samples, diameter 50mm or 2" with front operation elevator knob	BM-08-0053	
		(F)	6 position sample holder, for max. 6 embedded samples, diameter 50mm or 2" with front operation elevator knob	BM-08-0054	
			12 position sample holder, for max. 12 embedded samples, diameter 50mm or 2" with front operation elevator knob	BM-08-0056	
		(H)	1 insert reduction ring 25mm	UN-ESHI25	
		(I)	1 insert reduction ring 40mm	UN-ESHI40	
			1 insert reduction ring 1"	UN-ESHI1	
			1 insert reduction ring 1 1/4"	UN-ESHI125	
			1 insert reduction ring 1,5"	UN-ESHI15	
<b>STEP 8</b>	<b>Fixtures &amp; vices</b>				
(11)	Fixtures & vices	(A)	Polished precision vice with lock down system, jaw width 25mm, opens 20mm	UN-VICE/210	
		(B)	Polished precision vice with lock down system, jaw width 36mm, opens 42mm	UN-VICE/215	
		(C)	Polished precision vice with lock down system, jaw width 48mm, opens 75mm	UN-VICE/220	
		(D)	Polished precision vice with lock down system, jaw width 75mm, opens 100mm	UN-VICE/230	
		(E)	Axle chuck 500 series for cylinder parts, dia. 0.4mm to 5mm	UN-AXLECHUCK	
		(F)	Universal Clamp & Leveling Device	UN-CLAMP/105	
		(G)	Thin metal clamp	UN-CLAMP/115	
		(H)	V groove clamp for small round parts dia.0.8-5mm	UN-VGROOVE-CLAMP	
		(I)	Wire Testing Fixture for specimen dia. 0.8-3.5mm	UN-WIRE/105	
		(J)	JOMINY Fixture, for 1 quench end test sample, quick release function	UN-JOMFIX1	
		(K)	JOMINY Fixture, for 3 quench end test sample, quick release function	UN-JOMFIX3	
		(L)	Small parts vice jaw width 55mm, open 50mm, self centering	UN-VICE/115	
<b>STEP 9</b>	<b>Software</b>				
	Additional software		Manual on-screen measurement	UN-MANM	<b>STANDARD</b>
			Automatic measurement	UN-AUTOM	<b>STANDARD</b>
			Automatic focussing	UN-AUTOFOC	<b>STANDARD</b>
			Report configurator	UN-REPORTA	<b>STANDARD</b>
			Snapshot function	UN-SNAPSH	<b>STANDARD</b>
			Advanced 3 axis coordinate & free style indent pattern configurator, for motorized stage only	UN-TESTPAT01	
			Advanced 3 axis coordinate & free style indent pattern configurator, + CHD, SHD, NHD and edge detection, (supports manual & digital micrometer stages only)	UN-TESTPAT02	
			Image stitching, composes full stage overview, and detailed sample overview in high resolution. Requires a motorized stage.	UN-IMST01	
			KiC crack detection under load. Palmqvist & Median / Radial fracture toughness	UN-CRKPAP	
			Automatic Contour scanning	UN-CSCAN	
			2D / 3D hardness scanning (mapping, includes automatic contour scanning)	UN-CSCAN2D3D	
			Drawing and measuring (distance & angles) application	UN-DRMEAS	
			DualView Technology, 2 viewing screens software, screen, cables, Europe and US power cable included, 24" Industrial LCD screen included	UN-DVTECHSET24	
			Automatic edge detection	UN-EDGEDTC	
			Force depth/time diagram	UN-FDDIAGR	

# ACCESSORIES

## INDENTER SEATS

### Laser & touch probe



**A**  
SA-05-0027



**B**  
SA-10-0036



**C**  
SA-10-0045

### Indenter seats



**A**  
SA-10-0030



**B**  
SA-10-0035



**C**  
SA-10-0034



**D**  
SA-10-0033

## INDENTERS

### Indenters

**A**



Rockwell Diamond Indenter



1/16" Carbide Ball Indenter



1/8" Carbide Ball Indenter



1/4" Carbide Ball Indenter



1/2" Carbide Ball Indenter

**B**



1mm Carbide Ball Indenter Ø6.35mm



1mm Carbide Ball Indenter Ø3mm



2.5mm Carbide Ball Indenter Ø6.35mm



2.5mm Carbide Ball Indenter Ø3mm



5mm Carbide Ball Indenter Ø6.35mm



5mm Carbide Ball Indenter Ø3mm



10mm Carbide Ball Indenter Ø6.35mm

**C**



Macro Vickers Indenter Ø6.35mm



Micro Vickers Indenter Ø3mm

**D**



Micro Knoop Indenter Ø3mm



Macro Knoop Indenter Ø6.35mm

## OPTICAL

### Overview camera



CE-22-0148

### Objectives



0.7x Objective for Brinell



2.5x Long Working Distance objective



5x Long Working Distance objective



10x Long Working Distance objective



20x Long Working Distance objective



40x Long Working Distance objective



60x Long Working Distance objective



100x Long Working Distance objective

### Objectives

**A**



SA-05-0020

**B**



SA-05-0021

**C**



SA-05-0022

## STAGES/ANVILS

### Stages

**A**

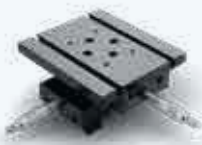

UN-TESTTABLE/030

**B**



UN-TESTTABLE/010  
UN-TESTTABLE/012  
CM-08-0194

**C**



UN-XYSTAGE-120

**D**



UN-TESTTABLE/015  
UN-TESTTABLE/016

## FIXTURES & VICES

### Fixtures & vices

A



UN-VICE/210

B



UN-VICE/215

C



UN-VICE/220

D



UN-VICE/230

E



UN-AXLECHUCK

F



UN-CLAMP/105

G



UN-CLAMP/115

H



UN-VGROOVE-CLAMP

I



UN-WIRE/105

J



UN-JOMFIX1

K



UN-JOMFIX3

L



UN-VICE/115

## ADDITIONAL ITEMS

### Machine stands

A



UN-STAND/960

B



UN-STAND/965

### Vibration isolation stage



UN-AVS-300

## MOTORIZED TOOL CHANGER

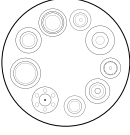
	<b>Motorized tool changer (turret)</b>	Ultra-fast, 9 position, 8 free to configure, 1 fixed
	<b>Free tool positions</b>	8 for indenters, 8 for objectives (8 max total)
	<b>Fixed tool positions</b>	1 for cross laser & touch probe
	<b>Objectives</b>	Long working distance 0.7x, 2.5x, 5x, 10x, 20x, 40x, 60x, 100x
	<b>Indenters</b>	Certified indenters (ISO/ASTM) available at choice
	<b>Camera 1 (objective)</b>	18 Mpx, HD, 4K+, Machine vision system
	<b>Camera 2 (overview)</b>	18 Mpx Full HD, Full Color, Optical zoom system, variable FOV 40 x 30mm - 140 x 110mm

## SYSTEM

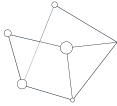
	<b>Electronic system Standard (Recommended)</b>	High performance embedded controller, i7 mSSD, 120 GB MS Windows® 10 operated , up to 8 years* INNOVATEST warranty
	<b>Electronic system (Optional)</b>	High performance external controller, i7 or i9 SSD, 1TB MS Windows® 10 operated, 1 year factory warranty
	<b>Screen(s)</b>	27" capacitive touchscreen, optional 27" or 2 x 24" (touch)screens (all landscape)
	<b>Display resolution</b>	0.01 HV, HK, HB
	<b>Statistics</b>	Total test, max, min, average, range, standard deviation, All in real time after each test
	<b>Hardness conversion</b>	Rockwell, Rockwell Superficial, Vickers, Brinell, Knoop, Leeb & Tensile
	<b>Software</b>	IMPRESSIONS™ V4, work flow system & tester control
	<b>Data storage capacity</b>	Internal and external mSSD, SSD or HDD
	<b>Data output</b>	XML, CSV, Certified for Q-DAS (optional)
	<b>Data input</b>	Keyboard, touchscreen, barcode scanner, database
	<b>Connectivity</b>	5 USB ports, RJ45 Ethernet LAN, W-LAN, RS-232, Blue Tooth, 5 Axis CNC & motorized XY-stage connector, Dual HDMI screen connectors
	<b>Printer</b>	A4, A3 full color laser printer (optional)

## GENERAL

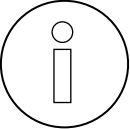
	<b>Machine dimension</b>	1100mm x 425mm x 695mm
	<b>Machine weight</b>	180 kg
	<b>Workpiece accommodation</b>	150mm (H) x 230mm (D)
	<b>Power supply</b>	100VAC to 240VAC, 50/60Hz, single phase
	<b>Operating temperature</b>	10°C to 35°C
	<b>Power consumption</b>	100W
	<b>Humidity</b>	10% to 90%, non-condensing
	<b>Noise</b>	< 70 db(A)

\* Check individual warranty conditions



# TECHNICAL DRAWINGS

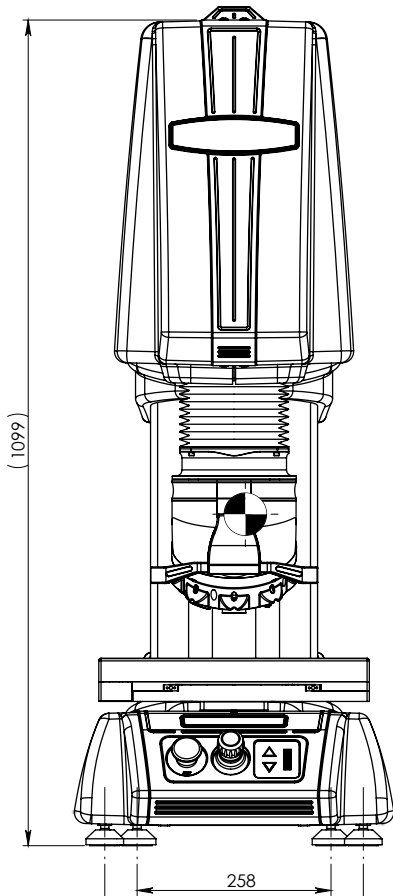

All dimensions in these drawings are in mm, approximate. Working heights and or workpiece accommodation varies depending on the stages and stage accessories used.

Please contact our sales department for more details.

