

Honeywell

Genesis™ XP 7680g

Presentation Area Imager



User Guide

Disclaimer

Honeywell International Inc. (“HII”) reserves the right to make changes in specifications and other information contained in this document without prior notice, and the reader should in all cases consult HII to determine whether any such changes have been made. HII makes no representation or warranties regarding the information provided in this publication.

HII shall not be liable for technical or editorial errors or omissions contained herein; nor for incidental or consequential damages resulting from the furnishing, performance, or use of this material. HII disclaims all responsibility for the selection and use of software and/or hardware to achieve intended results.

This document contains proprietary information that is protected by copyright. All rights are reserved. No part of this document may be photocopied, reproduced, or translated into another language without the prior written consent of HII.

Copyright © 2022 Honeywell Group of Companies. All rights reserved.

Web Address: sps.honeywell.com

Trademarks

Microsoft® Windows® and the Windows logo are trademarks or registered trademarks of the Microsoft group of companies.

The Bluetooth® word mark and logos are owned by Bluetooth SIG, Inc.

Apple is a trademark of Apple Inc., registered in the U.S. and other countries.

Other product names or marks mentioned in this document may be trademarks or registered trademarks of other companies and are the property of their respective owners.

Patents

For patent information, refer to www.hsmpats.com.

Licenses of Third-Party Software

Open source software licenses are available for download from the product page at sps.honeywell.com.

TABLE OF CONTENTS

Customer Support	xiii
Technical Assistance	xiii
Product Service and Repair	xiii
Limited Warranty	xiii
Chapter 1 - Get Started	1
About This Manual.....	1
Unpack Your Device.....	1
Scanner Features	2
Connect the Device.....	3
Connect with USB.....	3
Connect with Keyboard Wedge	4
Connect with RS232 Serial Port	5
Connect with RS485.....	6
Reading Techniques.....	6
Troubleshooting	7
Scanner Status LED Ring.....	7
Menu Barcode Security Settings	7
Set Custom Defaults	7
Reset the Custom Defaults.....	8
Chapter 2 - Program the Interface	9
Introduction.....	9
Program the Interface - Plug and Play.....	9
Keyboard Wedge.....	9

Laptop Direct Connect	10
RS232 Serial Port.....	10
RS485.....	10
USB IBM SurePos	11
USB PC or Macintosh Keyboard	12
USB HID.....	12
USB Serial.....	12
CTS/RTS Emulation.....	13
ACK/NAK Mode.....	13
Verifone® Ruby Terminal.....	13
Gilbarco® Terminal.....	14
Honeywell Bioptic Aux Port	14
Datalogic™ Magellan® Aux Port.....	14
Wincor Nixdorf Terminal.....	15
Wincor Nixdorf Beetle™ Terminal	15
Wincor Nixdorf RS232 Mode A.....	16
Keyboard Country Layout.....	16
Keyboard Wedge Modifiers	23
ALT Mode.....	23
Keyboard Style	24
Keyboard Conversion	25
Control Character Output.....	26
Keyboard Modifiers.....	26
RS232 Modifiers	28
RS232 Baud Rate	28
RS232 Word Length: Data Bits, Stop Bits, and Parity	29
RS232 Receiver Time-Out	30
RS232 Handshake	30
RS232 Timeout.....	31
XON/XOFF.....	31
ACK/NAK	32
Scanner to Bioptic Communication.....	32

Scanner-Bioptic Packet Mode.....	32
Scanner-Bioptic ACK/NAK Mode.....	33
Scanner-Bioptic ACK/NAK Timeout	33

Chapter 3 - Input/Output Settings35

Power Up Beeper	35
Beep on BEL Character	35
Trigger Click.....	36
Good Read and Error Indicators.....	36
Beeper – Good Read	36
Beeper Volume – Good Read	36
Beeper Pitch – Good Read	37
Beeper Pitch – Error	37
Beeper Duration – Good Read.....	38
LED – Good Read.....	38
Number of Beeps – Good Read.....	38
Number of Beeps – Error.....	38
Good Read Delay.....	39
User-Specified Good Read Delay	39
Object Detection Mode.....	40
Trigger Modes.....	40
Manual Trigger	40
Trigger Toggle	40
Serial Trigger.....	42
Presentation Mode	42
Triggered Presentation Mode.....	43
Presentation LED Behavior after Decode.....	43
Presentation Centering.....	43
Poor Quality Codes.....	45
Poor Quality 1D Codes	45
Poor Quality PDF Codes.....	46
Low Resolution PDF Codes	46
CodeGate™	46

Hands Free Time-Out.....	47
Reread Delay.....	47
User-Specified Reread Delay.....	48
2D Reread Delay	48
Character Activation.....	48
Activation Character	49
End Character Activation After Good Read.....	49
Character Activation Timeout	50
Character Deactivation.....	50
Deactivation Character	50
Illumination Lights.....	51
Aimer Delay	51
User-Specified Aimer Delay	52
Aimer Mode	52
Presentation Aimer Mode.....	53
Enhanced Object Detection	53
Centering	54
Single Code Centering	54
Custom Centering.....	54
Preferred Symbology.....	56
High Priority Symbology	57
Low Priority Symbology.....	57
Preferred Symbology Time-out.....	57
Preferred Symbology Default.....	57
Output Sequence Overview	58
Output Sequence Editor.....	58
To Add an Output Sequence	58
Output Sequence Editor Commands.....	59
Enter Output Sequence.....	62
Partial Sequence	62
Good Read Tone - Output Sequences.....	67
Multiple Symbols	68
No Read	68

Video Reverse.....	69
Working Orientation.....	70
Optimized Scanning for Tobacco Products.....	71

Chapter 4 - Data Edit73

Prefix/Suffix Overview	73
Points to Keep In Mind	73
Add a Prefix or Suffix:.....	74
Example: Add a Tab Suffix to All Symbologies	74
Clear One or All Prefixes or Suffixes.....	74
Add a Carriage Return Suffix to All Symbologies.....	75
Prefix Selections	75
Suffix Selections	75
Function Code Transmit.....	76
Intercharacter, Interfunction, and Intermessage Delays	76
Intercharacter Delay.....	76
User Specified Intercharacter Delay.....	77
Interfunction Delay.....	77
Intermessage Delay	78

Chapter 5 - Data Format79

Data Format Editor Introduction	79
Show Data Format	80
Add a Data Format.....	80
Other Programming Selections	81
Terminal ID Table.....	82
Data Format Editor Commands	82
Send Commands	82
Move Commands.....	88
Search Commands.....	89
Miscellaneous Commands	92
Data Formatter.....	95
Data Format Non-Match Error Tone.....	96

Primary/Alternate Data Formats	97
Single Scan Data Format Change	97

Chapter 6 - Symbologies..... 99

All Symbologies	100
Message Length Description.....	100
Codabar	100
Code 39.....	103
Interleaved 2 of 5	106
NEC 2 of 5.....	108
Code 93.....	109
Straight 2 of 5 Industrial (three-bar start/stop).....	111
Straight 2 of 5 IATA (two-bar start/stop).....	112
Matrix 2 of 5.....	113
Code 11.....	114
Code 128.....	115
ISBT 128 Concatenation	115
GS1-128	117
Telepen.....	118
UPC-A.....	119
UPC-A/EAN-13 with Extended Coupon Code.....	121
Coupon GS1 DataBar Output	122
UPC-E0	123
UPC-E1	125
EAN/JAN-13	126
ISBN Translate.....	133
EAN/JAN-8.....	133
MSI.....	135
GS1 DataBar Omnidirectional.....	137
GS1 DataBar Limited	138
GS1 DataBar Expanded	138
Trioptic Code.....	139

Codablock A.....	139
Codablock F.....	140
Label Code.....	141
PDF417.....	141
MacroPDF417.....	142
MicroPDF417.....	142
GS1 Composite Codes.....	143
GS1 Emulation.....	144
TCIF Linked Code 39 (TLC39).....	145
QR Code.....	146
DotCode.....	148
Digimarc Barcode™.....	149
Data Matrix.....	151
MaxiCode.....	152
Aztec Code.....	153
Chinese Sensible (Han Xin) Code.....	154
Postal Codes - 2D.....	155
Planet Code Check Digit.....	159
Postnet Check Digit.....	159
Australian Post Interpretation.....	159
Postal Codes - Linear.....	160
China Post (Hong Kong 2 of 5).....	160
Korea Post.....	161

Chapter 7 - Imaging Commands 163

Single-Use Basis.....	163
Command Syntax.....	163
Image Snap - IMGSNP.....	164
IMGSNP Modifiers.....	164
Image Ship - IMGSHIP.....	167
IMGSHIP Modifiers.....	168
Image Size Compatibility.....	175

Intelligent Signature Capture - IMGBOX	176
Signature Capture Optimize	176
IMGBOX Modifiers	177

Chapter 8 - Utilities.....183

To Add a Test Code I.D. Prefix to All Symbologies	183
Show Software Revision	183
Test Menu	183
TotalFreedom.....	184
Application Plug-Ins (Apps)	184
EZConfig for Scanning Introduction.....	185
Configure with EZConfig for Scanning.....	185
Reset the Factory Defaults.....	186

Chapter 9 - Serial Programming Commands.....187

Conventions	187
Menu Command Syntax	187
Query Commands.....	188
Trigger Commands.....	190
Reset the Custom Defaults	191
Menu Commands	192

Chapter 10 - Product Specifications.....217

Genesis XP 7680GSR Scanner Product Specifications	217
Depth of Field Charts	218
7680g Typical Performance.....	218
7680g Guaranteed Performance.....	219
Standard Connector Pinouts	219
Keyboard Wedge.....	219
Serial Output	220
RS485 Output.....	220
USB	221
Required Safety Labels	221

Chapter 11 - Maintenance and Troubleshooting	223
Repairs.....	223
Maintenance.....	223
Clean the Scanner.....	223
About Disinfectant-ready Models.....	224
Inspect Cords and Connectors.....	224
Replace Cable.....	224
Replace an Interface Cable.....	224
Troubleshoot.....	225
 Chapter A - Reference Charts	 227
Symbology Charts.....	227
Linear Symbologies	227
2D Symbologies	228
Postal Symbologies	229
ASCII Conversion Chart (Code Page 1252).....	230
Lower ASCII Reference Table.....	231
ISO 2022/ISO 646 Character Replacements	234
Keyboard Key References.....	237
 Sample Symbols.....	 239
 Programming Chart	 241

Customer Support

Technical Assistance

Go to sps.honeywell.com and select **Support** to search our knowledge base for a solution or to log into the Technical Support portal.

Product Service and Repair

Honeywell International Inc. provides service for all of its products through service centers throughout the world. Go to sps.honeywell.com and select **Support** to find a service center near you or to get a Return Material Authorization number (RMA #) before returning a product.

Limited Warranty

For warranty information, go to sps.honeywell.com and select **Support > Warranties**.

About This Manual

This User Guide provides installation and programming instructions for the Genesis XP 7680g hands-free area imaging scanner. Product specifications, dimensions, warranty, and customer support information are also included.

Honeywell barcode scanners are factory programmed for the most common terminal and communications settings. If you need to change these settings, programming is accomplished by scanning the barcodes in this guide.

An asterisk (*) next to an option indicates the default setting.

Unpack Your Device

After you open the shipping carton containing the product, take the following steps:

- Check for damage during shipment. Report damage immediately to the carrier who delivered the carton.
- Make sure the items in the carton match your order.
- Save the shipping container for later storage or shipping.

Scanner Features

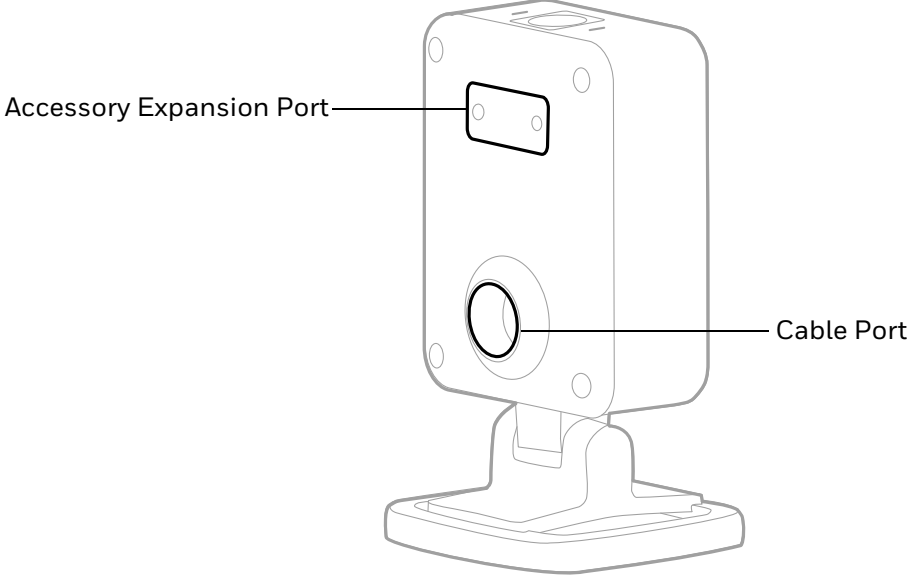
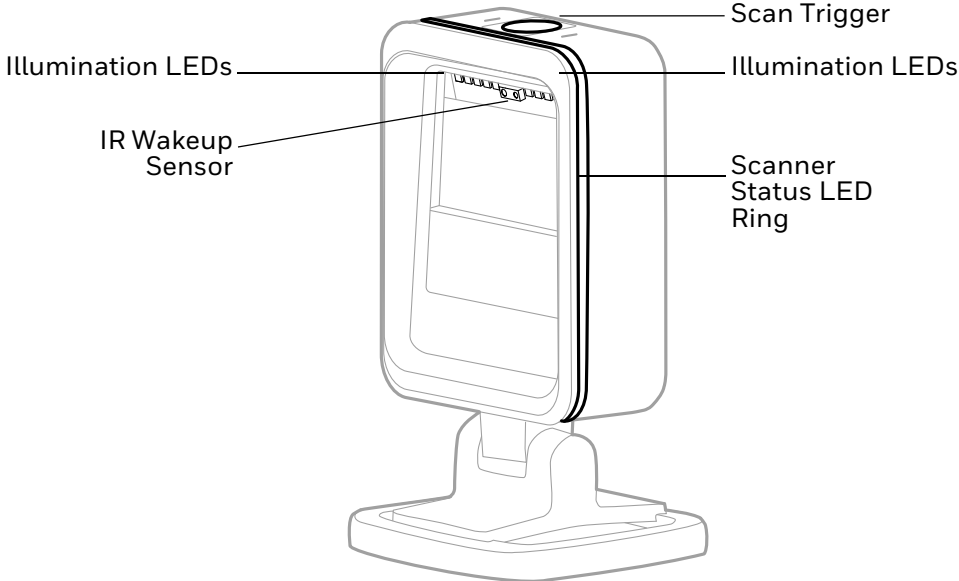

Connect the Device

Note: It is important to insert the black O-ring onto the end of the communication cable as shown, and make sure that the O-ring cannot be seen after the cable is inserted into the scanner. This ensures proper assembly and IP52 compliance function.

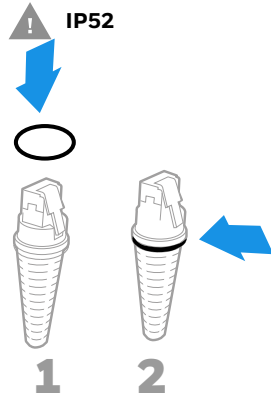

Connect with USB

A scanner can be connected to the USB port of a computer.

1. Connect the appropriate interface cable to the device first, then to the computer.

Genesis XP 7680 USB Connection:

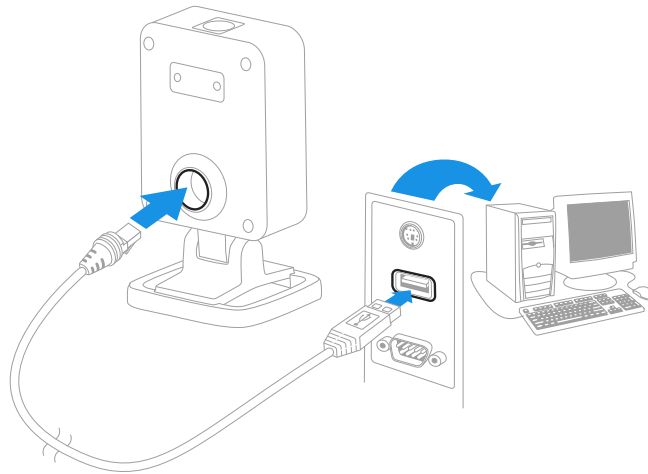

2. The scanner beeps.
3. Verify the scanner operation by scanning a barcode from the [Sample Symbols](#), beginning on page 239.

The unit defaults to a USB PC Keyboard. Refer to [page 12](#) for other USB terminal settings.

Connect with Keyboard Wedge

A scanner can be connected between the keyboard and PC as a “keyboard wedge,” where the scanner provides data output that is similar to keyboard entries. The following is an example of a keyboard wedge connection:

1. Turn off power and disconnect the keyboard cable from the back of the terminal/computer.
2. Connect the appropriate interface cable to the device and to the terminal/computer.

Genesis XP 7680 Scanner Keyboard Wedge Connection:

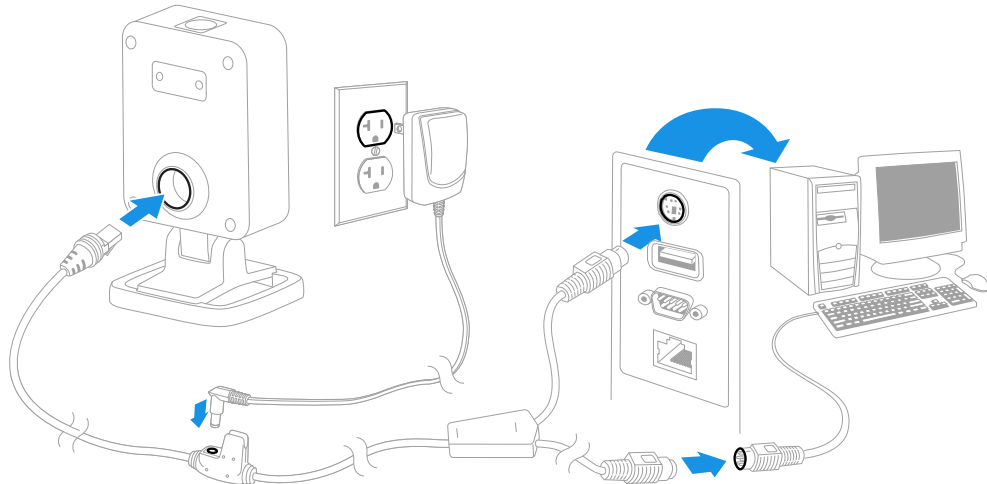

Note: The power supply must be ordered separately, if needed.

3. Turn the terminal/computer power back on. The scanner beeps.
4. Verify the scanner operation by scanning a barcode from the [Sample Symbols](#), beginning on page 239.

The unit defaults to an IBM PC AT and compatibles keyboard wedge interface with a USA keyboard. A carriage return (CR) suffix is added to barcode data.

Connect with RS232 Serial Port

1. Turn off power to the terminal/computer.
2. Connect the appropriate interface cable to the scanner.

Note: For the scanner to work properly, you must have the correct cable for your type of terminal/computer.

Genesis XP 7680 Scanner RS232 Serial Port Connection:

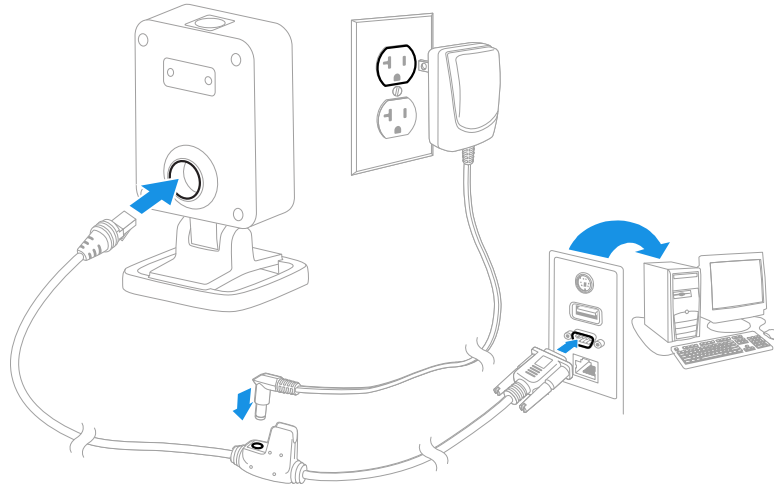

Note: The power supply must be ordered separately, if needed.

3. Plug the serial connector into the serial port on your computer. Tighten the two screws to secure the connector to the port.
4. Once the scanner has been fully connected, power up the computer.

This interface programs 115,200 baud, 8 data bits, no parity, and 1 stop bit.

Connect with RS485

A Xenon scanner can be connected for an IBM POS terminal interface.

1. Connect the appropriate interface cable to the device, then to the computer.

Genesis XP 7680 Scanner RS485 Connection:

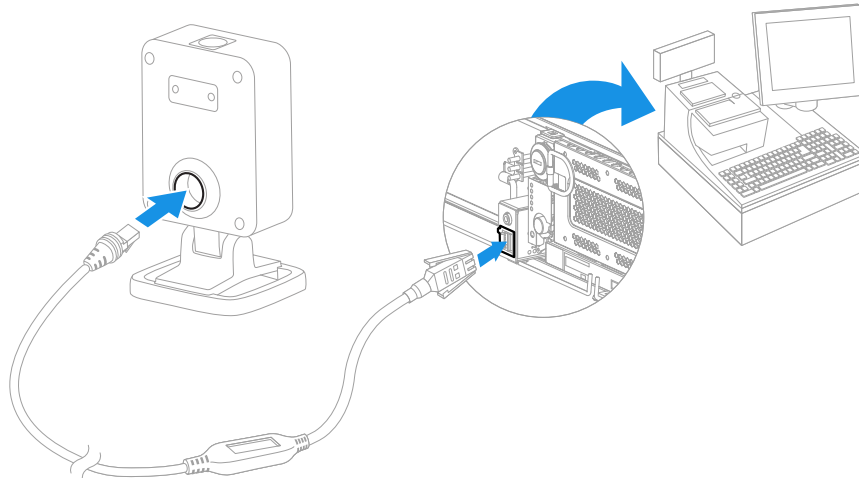

Note: The power supply must be ordered separately, if needed.

2. Turn the terminal/computer power back on. The scanner beeps.
3. Verify the scanner operation by scanning a barcode from the [Sample Symbols](#), beginning on page 239. The scanner beeps once.

For further RS485 settings, refer to [RS485](#) on page 10.

Reading Techniques

Present the barcode to the scanner. The illumination LEDs turn on.

Optional: For aiming assistance, press and hold the scan trigger button and center the aiming dot on the barcode.

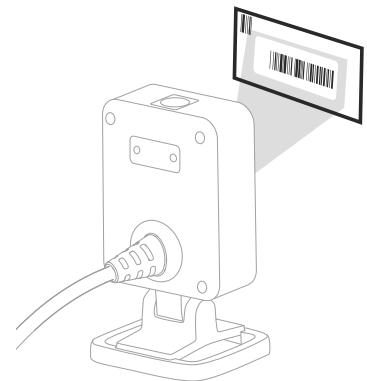
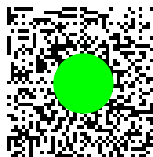

The aiming dot should be centered over the barcode, but it can be positioned in any direction for a good read. The aiming dot is smaller when the scanner is closer to the code and larger when it is farther from the code. Symbologies with smaller bars or elements (mil size) should be read closer to the unit. Symbologies with larger bars or elements (mil size) should be read farther from the unit.

Troubleshooting

- If the light level in the room is not high enough, the barcode may not be read.
- If the barcode is highly reflective (e.g., laminated), you may need to tilt the scanner at an angle so the barcode can be scanned.

Scanner Status LED Ring

The Genesis XP 7680 has a 360 degree LED ring that surrounds the scan region and provides feedback about the scanner status:

LED	Status
White	Idle: The Genesis XP is ready to scan and does not identify anything in the scan field.
Green	Good read
Red	Error

Menu Barcode Security Settings

Honeywell scanners are programmed by scanning menu barcodes or by sending serial commands to the scanner. If you want to restrict the ability to scan menu codes, you can use the Menu Barcode Security settings. Contact the nearest technical support office (see [Technical Assistance](#) on page xiii) for further information.

Set Custom Defaults

You have the ability to create a set of menu commands as your own, custom defaults. To do so, scan the **Set Custom Defaults** barcode below before scanning the menu commands for your custom defaults. If a menu command requires scanning numeric codes from the [Programming Chart](#), beginning on page 241,

then a **Save** code, that entire sequence will be saved to your custom defaults. When you have entered all the commands you want to save for your custom defaults, scan the **Save Custom Defaults** barcode.



You may have a series of custom settings and want to correct a single setting. To do so, just scan the new setting to overwrite the old one. For example, if you had previously saved the setting for Beeper Volume at Low to your custom defaults, and decide you want the beeper volume set to High, just scan the **Set Custom Defaults** barcode, then scan the Beeper Volume High menu code, and then **Save Custom Defaults**. The rest of the custom defaults will remain, but the beeper volume setting will be updated.

Reset the Custom Defaults

If you want the custom default settings restored to your scanner, scan the **Activate Custom Defaults** barcode below. This is the recommended default barcode for most users. It resets the scanner to the custom default settings. If there are no custom defaults, it will reset the scanner to the factory default settings. Any settings that have not been specified through the custom defaults will be defaulted to the factory default settings.



Introduction

This chapter describes how to program your system for the desired interface.

Program the Interface - Plug and Play

Plug and Play barcodes provide instant scanner set up for commonly used interfaces.

Note: After you scan one of the codes, power cycle the host terminal to have the interface in effect.

Keyboard Wedge

If you want your system programmed for an IBM PC AT and compatibles keyboard wedge interface with a USA keyboard, scan the barcode below. Keyboard wedge is the default interface.

Note: The following barcode also programs a carriage return (CR) suffix.



PAP_AT.

IBM PC AT and Compatibles with
CR suffix

Laptop Direct Connect

For most laptops, scanning the **Laptop Direct Connect** barcode allows operation of the scanner in parallel with the integral keyboard. The following **Laptop Direct Connect** barcode also programs a carriage return (CR) suffix and turns on Emulate External Keyboard (page 25).



RS232 Serial Port

The **RS232 Interface** barcode is used when connecting to the serial port of a PC or terminal. The following **RS232 Interface** barcode also programs a carriage return (CR) and a line feed (LF) suffix, baud rate, and data format as indicated below. It also changes the trigger mode to manual.

Option	Setting
Baud Rate	115,200 bps
Data Format	8 data bits, no parity bit, 1 stop bit



RS485

Scan one of the following “Plug and Play” codes to program the scanner for an IBM POS terminal interface.

Note: After scanning one of these codes, you must power cycle the cash register.





Each barcode above also programs the following suffixes for each symbology:

Symbology	Suffix	Symbology	Suffix
EAN 8	0C	Code 39	00 0A 0B
EAN 13	16	Interleaved 2 of 5	00 0D 0B
UPC A	0D	Code 128 *	00 0A 0B
UPC E	0A	Code 128 **	00 18 0B
		MaxiCode	00 2F 0B

* Suffixes programmed for Code 128 with IBM 4683 Port 5B, IBM 4683 Port 9B HHBCR-1, and IBM 4683 Port 17 Interfaces

** Suffixes programmed for Code 128 with IBM 4683 Port 9 HHBCR-2 Interface

USB IBM SurePos

Scan one of the following “Plug and Play” codes to program the scanner for an IBM SurePos (USB handheld scanner) or IBM SurePos (USB tabletop scanner) interface.

Note: After scanning one of these codes, you must power cycle the cash register.

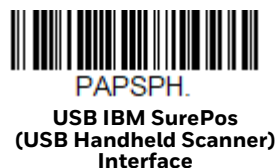

Each barcode above also programs the following suffixes for each symbology:

Symbology	Suffix	Symbology	Suffix
EAN 8	0C	Code 39	00 0A 0B
EAN 13	16	Interleaved 2 of 5	00 0D 0B
UPC A	0D	Code 128	00 18 0B
UPC E	0A	Code 39	00 0A 0B

USB PC or Macintosh Keyboard

Scan one of the following codes to program the scanner for USB PC Keyboard or USB Macintosh Keyboard. Scanning these codes also adds a CR suffix.



PAP124.
USB Keyboard (PC)



PAP125.
USB Keyboard (Mac)



TRMUSB134.
USB Japanese Keyboard (PC)

USB HID

Scan the following code to program the scanner for USB HID Barcode scanners.



PAP131.
USB HID Barcode Scanner

USB Serial

If you are using a Microsoft® Windows® PC, you will need to download the latest driver from the Honeywell website (sps.honeywell.com) and go to **Get Resources - Downloads - Software**. The driver will use the next available COM Port number. Apple® Macintosh computers recognize the scanner as a USB CDC class device and automatically use a class driver.

After the driver is downloaded, scan the following code to program the scanner to emulate a regular RS232-based COM Port.



TRMUSB130.
USB Serial

No extra configuration (e.g., baud rate) is necessary.

Note: *If you scan the USB Serial barcode either with an older Honeywell serial driver, or no driver installed, you may no longer be able to scan barcodes. If this happens, either uninstall the older driver versions and install the latest driver, or delete the specific device entry in Device Manager.*

CTS/RTS Emulation

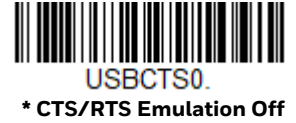

ACK/NAK Mode

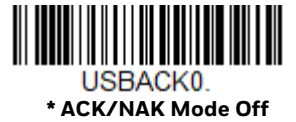

Verifone[®] Ruby Terminal

Scan the following Plug and Play code to program the scanner for a Verifone Ruby terminal. This barcode sets the baud rate to 1200 bps and the data format to 8 data bits, mark parity bit, 1 stop bit. It also adds a line feed (LF) suffix and programs the following prefixes for each symbology:

Symbology	Prefix
UPC-A	A
UPC-E	A
EAN-8	FF
EAN-13	F



Gilbarco[®] Terminal

Scan the following Plug and Play code to program the scanner for a Gilbarco terminal. This barcode sets the baud rate to 2400 bps and the data format to 7 data bits, even parity, 2 stop bits. It also adds a carriage return (CR) suffix and programs the following prefixes for each symbology:

Symbology	Prefix
UPC-A	A
UPC-E	EO
EAN-8	FF
EAN-13	F



PAPGLB.

Gilbarco Settings

Honeywell Bioptic Aux Port

Scan the following Plug and Play code to program the scanner for a Honeywell bioptic scanner auxiliary port configuration. This barcode sets the baud rate to 38400 bps and the data format to 8 data bits, no parity, 1 stop bit.



PAPBIO.

Honeywell Bioptic Settings

Datalogic[™] Magellan[®] Aux Port

Scan the following Plug and Play code to program the scanner for a Datalogic Magellan auxiliary port configuration. This barcode sets the baud rate to 9600 bps and the data format to 8 data bits, no parity, 1 stop bit.



PAPMAG.

Datalogic Magellan Settings

Wincor Nixdorf Terminal

Scan the following Plug and Play code to program the scanner for a Wincor Nixdorf terminal. This barcode sets the baud rate to 9600 bps and the data format to 8 data bits, no parity, 1 stop bit.



Wincor Nixdorf Beetle™ Terminal

Scan the following Plug and Play code to program the scanner for a Wincor Nixdorf Beetle terminal. The following prefixes are programmed for each symbology:

Symbology	Prefix	Symbology	Prefix
Aztec Code	V	Interleaved 2 of 5	I
Codabar	N	MaxiCode	T
Code 93	L	MicroPDF417	S
Code 128	K	PDF417	Q
Data Matrix	R	QR Code	U
EAN-8	B	Straight 2 of 5 IATA	H
EAN-13	A	UPC-A	AO
GS1 DataBar	E	UPC-E	C
GS1-128	P	All other barcodes	M



Wincor Nixdorf RS232 Mode A

Scan the following Plug and Play code to program the scanner for a Wincor Nixdorf RS232 Mode A terminal. This barcode sets the baud rate to 9600 bps and the data format to 8 data bits, odd parity, 1 stop bit. The following prefixes are programmed for each symbology:

Symbology	Prefix	Symbology	Prefix
Code 128	K	EAN-13	A
Code 93	L	GS1-128	K
Codabar	N	Interleaved 2 of 5	I
UPC-A	A0	Straight 2 of 5 IATA	H
UPC-E	C	GS1 DataBar	E
EAN-8	B		
All other barcodes	M		



PAPWMA.

Wincor Nixdorf RS232 Mode A
Settings

Keyboard Country Layout

If your interface is USB Keyboard or Keyboard Wedge, your keyboard layout default is a US keyboard. To change this layout, scan the appropriate Keyboard Country barcode below. By default, national character replacements are used for the following characters: # \$ @ [\] ^ ' { | } ~. Refer to the ["ISO 2022/ISO 646 Character Replacements" on page A-234](#) to view the character replacements for each country.

Keyboard Countries



KBDCTY0.

* United States



KBDCTY35.

Albania



KBDCTY81.

Azeri (Cyrillic)



KBDCTY80.

Azeri (Latin)

Keyboard Countries (Continued)



KBDCTY82.
Belarus



KBDCTY33.
Bosnia



KBDCTY59.
Brazil (MS)



KBDCTY53.
Bulgaria (Latin)



KBDCTY18.
Canada (French)



KBDCTY32.
Croatia



KBDCTY1.
Belgium



KBDCTY16.
Brazil



KBDCTY52.
Bulgaria (Cyrillic)



KBDCTY54.
Canada (French legacy)



KBDCTY55.
Canada (Multilingual)



KBDCTY15.
Czech

Keyboard Countries (Continued)



KBDCTY40.
Czech (Programmers)



KBDCTY38.
Czech (QWERTZ)



KBDCTY11.
Dutch (Netherlands)



KBDCTY83.
Faroese



KBDCTY3.
France



KBDCTY4.
Germany



KBDCTY39.
Czech (QWERTY)



KBDCTY8.
Denmark



KBDCTY41.
Estonia



KBDCTY2.
Finland



KBDCTY84.
Gaelic



KBDCTY17.
Greek

Keyboard Countries (Continued)



KBDCTY64.
Greek (220 Latin)



KBDCTY65.
Greek (319 Latin)



KBDCTY63.
Greek (Latin)



KBDCTY60.
Greek (Polytonic)



KBDCTY50.
Hungarian (101 key)



KBDCTY75.
Iceland



KBDCTY61.
Greek (220)



KBDCTY62.
Greek (319)



KBDCTY66.
Greek (MS)



KBDCTY12.
Hebrew



KBDCTY19.
Hungary



KBDCTY73.
Irish

Keyboard Countries (Continued)



KBDCTY56.
Italian (142)



KBDCTY28.
Japan ASCII



KBDCTY79.
Kyrgyz (Cyrillic)



KBDCTY42.
Latvia



KBDCTY44.
Lithuania



KBDCTY34.
Macedonia



KBDCTY5.
Italy



KBDCTY78.
Kazakh



KBDCTY14.
Latin America



KBDCTY43.
Latvia (QWERTY)



KBDCTY45.
Lithuania (IBM)



KBDCTY74.
Malta

Keyboard Countries (Continued)



KBDCTY86.
Mongolian (Cyrillic)



KBDCTY20.
Poland



KBDCTY58.
Polish (Programmers)



KBDCTY25.
Romania



KBDCTY67.
Russian (MS)



KBDCTY21.
SCS



KBDCTY9.
Norway



KBDCTY57.
Polish (214)



KBDCTY13.
Portugal



KBDCTY26.
Russia



KBDCTY68.
Russian (Typewriter)



KBDCTY37.
Serbia (Cyrillic)

Keyboard Countries (Continued)



KBDCTY36.
Serbia (Latin)



KBDCTY49.
Slovakia (QWERTY)



KBDCTY31.
Slovenia



KBDCTY51.
Spanish variation



KBDCTY29.
Switzerland (French)



KBDCTY85.
Tatar



KBDCTY22.
Slovakia



KBDCTY48.
Slovakia (QWERTZ)



KBDCTY10.
Spain



KBDCTY23.
Sweden



KBDCTY6.
Switzerland (German)



KBDCTY27.
Turkey F

Keyboard Countries (Continued)



KBDCTY24.
Turkey Q



KBDCTY76.
Ukrainian



KBDCTY7.
United Kingdom



KBDCTY87.
United States (Dvorak)



KBDCTY88.
United States (Dvorak left)



KBDCTY89.
United States (Dvorak right)



KBDCTY30.
United States (International)



KBDCTY77.
Uzbek (Cyrillic)

Keyboard Wedge Modifiers

ALT Mode

If your barcode contains special characters from the extended ASCII chart, for example, an e with an accent grave (è), you will use ALT Mode. (See [Extended ASCII Characters](#) on page 231.)

Note: Scan the ALT mode barcode after scanning the appropriate Keyboard Country code.

If your keystrokes require the ALT key and 3 or 4 characters, scan the **3 Characters** or **4 Characters** barcode. The data is then output with the special character(s) for values 00-255. *Default = Off.*



KBDALT0.

* Off



KBDALT6.

3 Characters



KBDALT7.

4 Characters

Keyboard Style

This programs keyboard styles, such as Caps Lock and Shift Lock. If you have used [Keyboard Conversion](#) settings, they will override any of the following Keyboard Style settings. *Default = Regular.*

Regular is used when you normally have the Caps Lock key off.



KBDSTY0.

* Regular

Caps Lock is used when you normally have the Caps Lock key on.



KBDSTY1.

Caps Lock

Shift Lock is used when you normally have the Shift Lock key on (not common to U.S. keyboards).



KBDSTY2.

Shift Lock

Automatic Caps Lock is used if you change the Caps Lock key on and off. The software tracks and reflects if you have Caps Lock on or off. This selection can only be used with systems that have an LED that notes the Caps Lock status (AT keyboards).

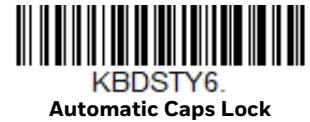

Autocaps via NumLock barcode should be scanned in countries (e.g., Germany, France) where the Caps Lock key cannot be used to toggle Caps Lock. The NumLock option works similarly to the regular Autocaps, but uses the NumLock key to retrieve the current state of the Caps Lock.

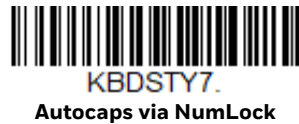

Emulate External Keyboard should be scanned if you do not have an external keyboard (IBM AT or equivalent).



Note: After scanning the Emulate External Keyboard barcode, you must power cycle your computer.

Keyboard Conversion

Alphabetic keyboard characters can be forced to be all upper case or all lowercase. So if you have the following barcode: “abc569GK,” you can make the output “ABC569GK” by scanning **Convert All Characters to Upper Case**, or to “abc569gk” by scanning **Convert All Characters to Lower Case**.

These settings override [Keyboard Style](#) selections.

Note: If your interface is a keyboard wedge, first scan the menu code for [Automatic Caps Lock](#) (page 25). Otherwise, your output may not be as expected.

Default = Keyboard Conversion Off.





Control Character Output

This selection sends a text string instead of a control character. For example, when the control character for a carriage return is expected, the output would display [CR] instead of the ASCII code of 0D. Refer to [ASCII Conversion Chart \(Code Page 1252\)](#) on page 230. Only codes 00 through 1F are converted (the first column of the chart). *Default = Off.*

Note: *Control + X (Control + ASCII) Mode overrides this mode.*



Keyboard Modifiers

This modifies special keyboard features, such as CTRL+ ASCII codes and Turbo Mode.

Control + X (Control + ASCII) Mode On: The scanner sends key combinations for ASCII control characters for values 00-1F. Windows is the preferred mode. All keyboard country codes are supported. DOS mode is a legacy mode, and it does not support all keyboard country codes. New users should use the Windows mode. Refer to [ASCII Conversion Chart \(Code Page 1252\)](#), page 230 for CTRL+ X Values.

Windows Mode Prefix/Suffix Off: The scanner sends key combinations for ASCII control characters for values 00-1F, but it does not translate prefix or suffix information.

Support ALT 3 Digit HEX Mode: The scanner sends key combinations for ASCII control characters for values 00-1F transmitted as the ALT key and 3 digits.

Default = Control + X Mode Off.

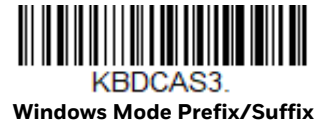

Turbo Mode: The scanner sends characters to a terminal faster. If the terminal drops characters, do not use Turbo Mode. *Default = Off.*



Numeric Keypad Mode: Sends numeric characters as if entered from a numeric keypad. *Default = Off.*

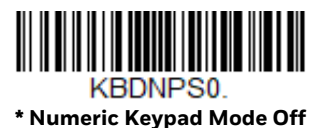
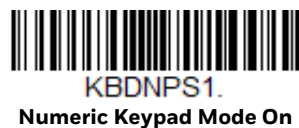

Automatic Direct Connect Mode: This selection can be used if you have an IBM AT style terminal and the system is dropping characters. *Default = Off.*



KBDADC1.

Automatic Direct Connect
Mode On



KBDADC0.

* Automatic Direct Connect
Mode Off

RS232 Modifiers

RS232 Baud Rate

Baud Rate sends the data from the scanner to the terminal at the specified rate. The host terminal must be set for the same baud rate as the scanner. *Default = 115,200.*



232BAD0.

300



232BAD1.

600



232BAD2.

1200



232BAD3.

2400



232BAD4.

4800



232BAD5.

9600



232BAD6.
19200



232BAD7.
38400



232BAD8.
57,600



232BAD9.
* 115,200

RS232 Word Length: Data Bits, Stop Bits, and Parity

Data Bits sets the word length at 7 or 8 bits of data per character. If an application requires only ASCII Hex characters 0 through 7F decimal (text, digits, and punctuation), select 7 data bits. For applications that require use of the full ASCII set, select 8 data bits per character. *Default = 8.*

Stop Bits sets the stop bits at 1 or 2. *Default = 1.*

Parity provides a means of checking character bit patterns for validity. *Default = None.*



232WRD3.
7 Data, 1 Stop, Parity Even



232WRD0.
7 Data, 1 Stop, Parity None



232WRD6.
7 Data, 1 Stop, Parity Odd



232WRD4.
7 Data, 2 Stop, Parity Even



232WRD1.
7 Data, 2 Stop, Parity None



RS232 Receiver Time-Out

The unit stays awake to receive data until the RS232 Receiver Time-Out expires. A manual or serial trigger resets the time-out. When an RS232 receiver is sleeping, a character may be sent to wake up the receiver and reset the time-out. A transaction on the CTS line will also wake up the receiver. The receiver takes 300 milliseconds to completely come up. Change the RS232 receiver time-out by scanning the barcode below, then scanning digits from the [Programming Chart](#), beginning on page 241, then scanning **Save**. The range is 0 to 300 seconds. *Default = 0 seconds (no time-out - always on).*



RS232 Handshake

RS232 Handshaking allows control of data transmission from the scanner using software commands from the host device. When RTS/CTS is turned Off, no data flow control is used.

Flow Control, No Timeout: The scanner asserts RTS when it has data to send, and will wait indefinitely for CTS to be asserted by the host.

Two-Direction Flow Control: The scanner asserts RTS when it is OK for the host to transmit. The host asserts CTS when it is OK for the device to transmit.

Flow Control with Timeout: The scanner asserts RTS when it has data to send and waits for a delay (see [RS232 Timeout](#) on page 31) for CTS to be asserted by the host. If the delay time expires and CTS is not asserted, the device transmit buffer is cleared and scanning may resume. *Default = RTS/CTS Off.*



232CTS1.

Flow Control, No Timeout



232CTS2.

Two-Direction Flow Control



232CTS3.

Flow Control with Timeout



232CTS0.

* RTS/CTS Off

RS232 Timeout

When using **Flow Control with Timeout**, you must program the length of the delay you want to wait for CTS from the host. Set the length (in milliseconds) for a timeout by scanning the barcode below, then setting the timeout (from 1-5100 milliseconds) by scanning digits from the [Programming Chart](#), beginning on page 241, then scanning **Save**.



232DEL.

RS232 Timeout

XON/XOFF

Standard ASCII control characters can be used to tell the scanner to start sending data (XON/XOFF On) or to stop sending data (XON/XOFF Off). When the host sends the XOFF character (DC3, hex 13) to the scanner, data transmission stops. To resume transmission, the host sends the XON character (DC1, hex 11). Data transmission continues where it left off when XOFF was sent. *Default = XON/XOFF Off.*



232XON1.

XON/XOFF On



232XON0.

* XON/XOFF Off

ACK/NAK

After transmitting data, the scanner waits for an ACK character (hex 06) or a NAK character (hex 15) response from the host. If ACK is received, the communications cycle is completed and the scanner looks for more barcodes. If NAK is received, the last set of barcode data is retransmitted and the scanner waits for ACK/NAK again. Turn on the ACK/NAK protocol by scanning the **ACK/NAK On** barcode below. To turn off the protocol, scan **ACK/NAK Off**. *Default = ACK/NAK Off.*



232ACK1.

ACK/NAK On



232ACK0.

* ACK/NAK Off

Scanner to Bioptic Communication

The following settings are used to set up communication between Honeywell scanners and bioptic scanners.

Note: *The scanner's baud rate must be set to 38400 and the RS232 timeout must be set to 3000 in order to communicate with a bioptic scanner. See "RS232 Modifiers" on page 28, and [RS232 Timeout](#) on page 31 for further information.*

Scanner-Bioptic Packet Mode

Packet Mode On must be scanned to set the scanner's format so it is compatible with a bioptic scanner. *Default = Packet Mode Off.*



232PKT0.

* Packet Mode Off



232PKT2.

Packet Mode On

Scanner-Biopic ACK/NAK Mode

Biopic ACK/NAK On must be scanned so the scanner will wait for an ACK or NAK from a biopic scanner after each packet is sent. The Scanner-Biopic ACK/NAK Timeout (below) controls how long the scanner will wait for a response. *Default = Biopic ACK/NAK Off.*



232NAK0.

* Biopic ACK/NAK Off



232NAK1.

Biopic ACK/NAK On

Scanner-Biopic ACK/NAK Timeout

This allows you to set the length (in milliseconds) for a timeout for a biopic scanner's ACK/NAK response. Scan the barcode below, then set the timeout (from 1-30,000 milliseconds) by scanning digits from the [Programming Chart](#), beginning on page 241, then scanning **Save**. *Default = 5100.*



232DLK.

ACK/NAK Timeout

Power Up Beeper

The scanner can be programmed to beep when it's powered up. Scan the **Off** barcode(s) if you don't want a power up beep. *Default = Power Up Beeper On - Scanner.*



BEPPWR0.

Power Up Beeper Off -
Scanner



BEPPWR1.

* Power Up Beeper On -
Scanner

Beep on BEL Character

You may wish to force the scanner to beep upon a command sent from the host. If you scan the **Beep on BEL On** barcode below, the scanner will beep every time a BEL character is received from the host. *Default = Beep on BEL Off.*



BELBEP0.

*Beep on BEL Off



BELBEP1.

Beep on BEL On

Trigger Click

To hear an audible click every time the scanner trigger is pressed, scan the **Trigger Click On** barcode below. Scan the **Trigger Click Off** code if you don't wish to hear the click. (This feature has no effect on serial or automatic triggering.) *Default = Trigger Click Off.*



Good Read and Error Indicators

Beeper – Good Read

The beeper may be programmed **On** or **Off** in response to a good read. Turning this option off only turns off the beeper response to a good read indication. All error and menu beeps are still audible. *Default = Beeper - Good Read On.*



Beeper Volume – Good Read

The beeper volume codes modify the volume of the beep the scanner emits on a good read. *Default = High for Xenon XP, Low for Xenon XP healthcare scanners.*





BEPLVL3.

* High



BEPLVL0.

Off

Beeper Pitch – Good Read

The beeper pitch codes modify the pitch (frequency) of the beep the scanner emits on a good read. *Default = Medium.*



BEPFQ11600.

Low (1600 Hz)



BEPFQ12700.

* Medium (2700 Hz)



BEPFQ14200.

High (4200 Hz)

Beeper Pitch – Error

The beeper pitch codes modify the pitch (frequency) of the sound the scanner emits when there is a bad read or error. *Default = Razz.*



BEPFQ2250.

* Razz (250 Hz)



BEPFQ23250.

Medium (3250 Hz)



BEPFQ24200.

High (4200 Hz)

Beeper Duration – Good Read

The beeper duration codes modify the length of the beep the scanner emits on a good read. *Default = Normal.*



BEPBIP0.

* Normal Beep



BEPBIP1.

Short Beep

LED – Good Read

The LED indicator can be programmed **On** or **Off** in response to a good read. *Default = On.*



BEPLED1.

* LED - Good Read On



BEPLED0.

LED - Good Read Off

Number of Beeps – Good Read

The number of beeps of a good read can be programmed from 1 - 9. The same number of beeps will be applied to the beeper and LED in response to a good read. For example, if you program this option to have five beeps, there will be five beeps and five LED flashes in response to a good read. The beeps and LED flashes are in sync with one another. To change the number of beeps, scan the barcode below and then scan a digit (1-9) barcode from the [Programming Chart](#), beginning on page 241, then **Save**. *Default = 1.*



BEPRPT.

Number of Good Read Beeps/LED Flashes

Number of Beeps – Error

The number of beeps and LED flashes emitted by the scanner for a bad read or error can be programmed from 1 - 9. For example, if you program this option to have five error beeps, there will be five error beeps and five LED flashes in response

to an error. To change the number of error beeps, scan the barcode below and then scan a digit (1-9) barcode from the [Programming Chart](#), beginning on page 241, then **Save**. *Default = 1.*



Good Read Delay

This sets the minimum amount of time before the scanner can read another barcode. *Default = 0 ms (No Delay).*



User-Specified Good Read Delay

If you want to set your own length for the good read delay, scan the barcode below, then set the delay (from 0 - 30,000 milliseconds) by scanning digits from the [Programming Chart](#), beginning on page 241, then **Save**.



Object Detection Mode

Object Detection Mode uses an infrared (IR) beam to detect when an object is in the scanner's field of view. When an object is detected, the scanner attempts to scan the barcode. Scan **Object Detection Mode** then the **Short Range** code for a target that's approximately 6 inches (15cm) away. Or, scan **Object Detection Mode** then the **Mid Range** code for a target that's approximately 9 inches (23cm) away.



PAPTIR.

Object Detection Mode



AOSRNG1.

***Object Detection - Short Range**



AOSRNG2.

Object Detection - Mid Range

Trigger Modes

Manual Trigger

Scan the Manual Trigger - Normal code to require that the scan trigger be pressed to read. When in manual trigger mode, the scanner scans until a barcode is read, or until the scan trigger is released. Two modes are available, **Normal** and **Enhanced**. Normal mode offers good scan speed and the longest working ranges (depth of field). Enhanced mode will give you the highest possible scan speed but slightly less range than Normal mode. Enhanced mode is best used when you require a very fast scan speed and don't require a long working range.



PAPHHF.

Manual Trigger - Normal



PAPHHS.

**Manual Trigger -
Enhanced**

Trigger Toggle

Trigger Toggle mode lets you quickly hit the trigger two or three times to put the scanner into either imaging mode or centering mode, then toggle back to scanning. So, like a double-click with a mouse, you can control what the next

scanner's action will be. For example, you could double-press the trigger to go into imaging mode, then the next trigger press takes the image. The scanner then reverts to scanning mode. Use the following codes to configure what action you would like the scanner to take when in Trigger Toggle mode.



TRGTGM0.

*Trigger Toggle Off



TRGTGM1.

Trigger Toggle - Image Capture



TRGTGM3.

Trigger Toggle - Centering

Trigger Number

This sets the number of trigger presses required to activate the Trigger Toggle Mode.



TRGTPC2.

2 Quick Triggers



TRGTPC3.

3 Quick Triggers



TRGTPC4.

4 Quick Triggers

Trigger Timing

This sets the timing of the trigger presses in order to qualify as a trigger toggle, rather than a regular trigger press. After scanning the **Trigger Timing** barcode, set the time-out duration (from 50-2,000 milliseconds) by scanning digits from the [Programming Chart](#), beginning on page 241, then **Save**. *Default = 400ms.*



TRGTTL.

Trigger Timing

Trigger Toggle Timeout

This sets the length of time the scanner stays in trigger toggle mode before reverting to scan mode. After scanning the **Trigger Toggle Timeout** barcode, set the time-out duration (from 0 to 65 seconds) by scanning digits from the [Programming Chart](#), beginning on page 241, then **Save**. *Default = 5 seconds.*

Note: *If this is set to 0, you must repeat the toggle sequence to return to the default scanning mode. For example, if 2 quick trigger presses puts the scanner into centering mode and the Trigger Timing is 0, you would have to do 2 quick presses again to go back to the default scanning mode.*



Serial Trigger

You can activate the scanner either by pressing the trigger, or using a serial trigger command (see [Trigger Commands](#) on page 190). You must be in a serial interface mode in order to use serial triggering. Refer to [RS232 Serial Port](#) (page 10) or [USB Serial](#) (page 12) for further information. When in serial mode, the scanner scans until a barcode has been read or until the deactivate command is sent. The scanner can also be set to turn itself off after a specified time has elapsed (see [Read Time-Out](#), which follows).

Read Time-Out

Use this selection to set a time-out (in milliseconds) of the scanner's trigger when using serial commands to trigger the scanner. Once the scanner has timed out, you can activate the scanner either by pressing the trigger or using a serial trigger command. After scanning the **Read Time-Out** barcode, set the time-out duration (from 0-300,000 milliseconds) by scanning digits from the [Programming Chart](#), beginning on page 241, then **Save**. *Default = 30,000 ms.*



Presentation Mode

Presentation Mode uses ambient light and scanner illumination to detect barcodes. When in Presentation Mode, the LEDs remain dim until a barcode is presented to the scanner, then the aimer turns on and the LEDs turn up to read the code. If the light level in the room is not high enough, Presentation Mode may not work properly.

Scan the following barcode to program your scanner for Presentation Mode.



Triggered Presentation Mode

This mode uses light to detect the presence of an object. *Default = Ambient and Scanner Light.*



Presentation LED Behavior after Decode

When a scanner is in presentation mode, the LED aimer dims 30 seconds after a barcode is decoded. If you wish to dim the LED aimer immediately after a barcode is decoded, scan the **LEDs Off** barcode, below. *Default = LEDs On.*



Presentation Centering

Use Presentation Centering to narrow the scanner's field of view when it is in the stand to make sure the scanner reads only those barcodes intended by the user. For instance, if multiple codes are placed closely together, Presentation Centering will insure that only the desired codes are read.

Note: To adjust centering when the scanner is hand-held, see [Centering](#) (page 3-54).

If a barcode is not touched by a predefined window, it will not be decoded or output by the scanner. If Presentation Centering is turned on by scanning **Presentation Centering On**, the scanner only reads codes that pass through the centering

window you specify using the **Top of Presentation Centering Window**, **Bottom of Presentation Centering Window**, **Left**, and **Right of Presentation Centering Window** barcodes.

In the example below, the white box is the centering window. The centering window has been set to 20% left, 30% right, 8% top, and 25% bottom. Since Barcode 1 passes through the centering window, it will be read. Barcode 2 does not pass through the centering window, so it will not be read.

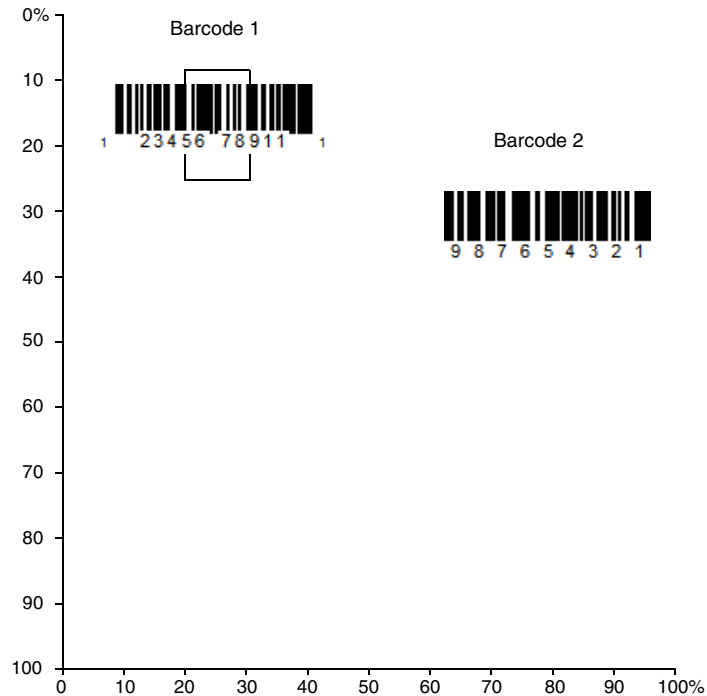

Note: A barcode needs only to be touched by the centering window in order to be read. It does not need to pass completely through the centering window.

Scan **Presentation Centering On**, then scan one of the following barcodes to change the top, bottom, left, or right of the centering window. Then scan the percent you want to shift the centering window from the [Programming Chart](#), beginning on page 241, then **Save**. Default Presentation Centering = 40% for Top and Left, 60% for Bottom and Right.





PDCTOP.
Top of Presentation
Centering Window



PDCBOT.
Bottom of Presentation
Centering Window



PDCLFT.
Left of
Presentation Centering
Window



PDCRGT.
Right of Presentation
Centering Window

Poor Quality Codes

Poor Quality 1D Codes

This setting improves the scanner's ability to read damaged or badly printed linear barcodes. When **Poor Quality 1D Reading On** is scanned, poor quality linear barcode reading is improved, but the scanner's snappiness is decreased, making it less aggressive when reading good quality barcodes. This setting does not affect 2D barcode reading. *Default = Poor Quality 1D Reading Off.*



DECLD11.
Poor Quality 1D Reading On



DECLD10.
* Poor Quality 1D Reading Off

Poor Quality PDF Codes

This setting improves the scanner's ability to read damaged or badly printed PDF codes by combining information from multiple images. It is useful when a complete barcode cannot be seen in one image. This setting does not affect 1D barcode reading. *Default = Poor Quality PDF Reading On.*



*Poor Quality PDF Reading On



Poor Quality PDF Reading Off

Low Resolution PDF Codes

This setting improves the scanner's ability to read low resolution PDF codes. When **Low Resolution PDF Codes On** is scanned, poor quality PDF code reading is improved, but the scanner's snappiness is decreased, making it less aggressive when reading good quality barcodes. This setting does not affect 1D barcode reading. *Default = Low Resolution PDF Codes Off.*



Low Resolution PDF Codes On



* Low Resolution PDF Codes Off

CodeGate™

When CodeGate is **On**, the trigger is used to allow decoded data to be transmitted to the host system. The scanner remains on, scanning and decoding barcodes, but the barcode data is not transmitted until the trigger is pressed. When CodeGate is **Off**, barcode data is transmitted when it is decoded. *Default = CodeGate Off Out-of-Stand.*



* CodeGate Off
Out-of-Stand



AOSCGD1.
CodeGate On
Out-of-Stand

Hands Free Time-Out

Presentation Mode is referred to as a “hands free” mode. If the scanner’s trigger is pulled when using a hands free mode, the scanner changes to manual trigger mode. You can set the time the scanner should remain in manual trigger mode by setting the Hands Free Time-Out. Once the time-out value is reached, (if there have been no further trigger pulls) the scanner reverts to the original hands free mode.

Scan the **Hands Free Time-Out** barcode, then scan the time-out duration (from 0-300,000 milliseconds) from the [Programming Chart](#), beginning on page 241, then **Save**. *Default = 5,000 ms.*



TRGPTO.
Hands Free Time-Out

Reread Delay

This sets the time period before the scanner can read the *same* barcode a second time. Setting a reread delay protects against accidental rereads of the same barcode. Longer delays are effective in minimizing accidental rereads. Use shorter delays in applications where repetitive barcode scanning is required. Reread Delay only works when in a [Presentation Mode](#) (see page 42). *Default = Medium.*



DLYRRD500.
Short (500 ms)



DLYRRD750.
* Medium (750 ms)



DLYRRD1000.
Long (1000 ms)



DLYRRD2000.
Extra Long (2000 ms)

User-Specified Reread Delay

If you want to set your own length for the reread delay, scan the barcode below, then set the delay (from 0-30,000 milliseconds) by scanning digits from the [Programming Chart](#), beginning on page 241, then **Save**.



2D Reread Delay

Sometimes 2D barcodes can take longer to read than other barcodes. If you wish to set a separate Reread Delay for 2D barcodes, scan one of the programming codes that follows. **2D Reread Delay Off** indicates that the time set for [Reread Delay](#) is used for both 1D and 2D barcodes. *Default = 2D Reread Delay Off.*



Character Activation

You may use a character sent from the host to trigger the scanner to begin scanning. When the activation character is received, the scanner continues scanning until either the [Character Activation Timeout](#) (page 3-50) is reached, the deactivation character is received (see [Deactivation Character](#) on page 50), or a

barcode is transmitted. Scan the **On** barcode to use character activation, then use [Activation Character](#) (page 49) to select the character you will send from the host to start scanning. *Default = Off.*



Activation Character

This sets the character used to trigger scanning when using Character Activation Mode. On the [ASCII Conversion Chart \(Code Page 1252\)](#), page 230, find the hex value that represents the character you want to use to trigger scanning. Scan the following barcode, then use the [Programming Chart](#) to read the alphanumeric combination that represents that ASCII character. Scan **Save** to finish. *Default = 12 [DC2].*



End Character Activation After Good Read

After a barcode is successfully detected and read from the scanner, the illumination can be programmed either to remain on and scanning, or to turn off. When **End Character Activation After Good Read** is enabled, the illumination turns off and stops scanning after a good read. If you scan **Do Not End Character Activation After Good Read**, the illumination remains on after a good read.



Character Activation Timeout

You can set a timeout for the length of time the illumination remains on and attempting to decode barcodes when using Character Activation Mode. Set the length (in milliseconds) for a timeout by scanning the following barcode, then setting the timeout (from 1-300,000 milliseconds) by scanning digits from the [Programming Chart](#), beginning on page 241, then **Save**. *Default = 30,000 ms.*



HSTCDT.

Character Activation Timeout

Character Deactivation

If you have sent a character from the host to trigger the scanner to begin scanning, you can also send a deactivation character to stop scanning. Scan the following **On** barcode to use character deactivation, then use **Deactivation Character** (following) to select the character you will send from the host to terminate scanning. *Default = Off.*



HSTDEN0.

* Off



HSTDEN1.

On

Deactivation Character

This sets the character used to terminate scanning when using Character Deactivation Mode. On the [ASCII Conversion Chart \(Code Page 1252\)](#), page 230, find the hex value that represents the character you want to use to terminate scanning. Scan the following barcode, then use the [Programming Chart](#), beginning on page 241 to read the alphanumeric combination that represents that ASCII character. Scan **Save** to finish. *Default = 14 [DC4].*



HSTDCH.

Deactivation Character

Illumination Lights

If you want the illumination lights on while reading a barcode, scan the **Lights On** barcode, below. However, if you want to turn just the lights off, scan the **Lights Off** barcode. *Default = Lights On.*

Note: *This setting does not affect the aimer light. The aiming light can be set using [Aimer Mode](#) (page 52).*



SCNLED1.
* Lights On



SCNLED0.
Lights Off

Aimer Delay

The aimer delay allows a delay time for the operator to aim the scanner before the picture is taken. Use these codes to set the time between when the trigger is pulled and when the picture is taken. During the delay time, the aiming light will appear, but the LEDs won't turn on until the delay time is over. *Default = Off.*



SCNDLY1.
1 millisecond



SCNDLY250.
250 milliseconds



SCNDLY500.
500 milliseconds



SCNDLY0.
* Off (no)

User-Specified Aimer Delay

If you want to set your own length for the duration of the delay, scan the barcode below, then set the time-out by scanning digits (0 - 4,000 ms) from the [Programming Chart](#), beginning on page 241, then **Save**.



Aimer Mode

This feature allows you to turn the aimer on and off. When the **Interlaced** barcode is scanned, the aimer is interlaced with the illumination LEDs. *Default = Interlaced*



Presentation Aimer Mode

This feature allows you to turn the aimer on and off while the scanner is in Presentation Mode, Presentation - Mobile Phone, Streaming Presentation Mode, or Streaming Presentation - Mobile Phone. When the Interlaced bar code is scanned, the aimer is interlaced with the illumination LEDs. *Default = Aimer Off.*



Enhanced Object Detection

When in Enhanced Object Detection mode, the scan illumination remains on all the time to continuously search for bar codes. When in Normal Object Detection mode, the scan illumination turns on while reading a bar code and is off when idle. Enhanced mode offers better object detection sensitivity. *Default = Normal Object Detection.*

Note: Note: Enhanced Object Detection only works while in Presentation Mode (TRGMOD3) ([page 42](#)).



Centering

Use Centering to narrow the scanner's field of view to make sure that when the scanner is hand-held, it reads only those barcodes intended by the user. For instance, if multiple codes are placed closely together, centering will insure that only the desired codes are read. (Centering can be used in conjunction with [Aimer Delay](#), page 51, for the most error-free operation in applications where multiple codes are spaced closely together. Using the Aimer Delay and Centering features, the scanner can emulate the operation of older systems, such as linear laser barcode scanners.)

Note: *To adjust centering when the scanner is in a stand, see [Presentation Centering](#) (page 3-43).*

Single Code Centering

Scan **Single Code Centering** to target the barcode closest to the center of the image. Singling out a barcode in this manner increases scanning accuracy when there are multiple barcodes close together.



Single Code Centering

Custom Centering

Use the following settings to customize your centering window. If a barcode is not touched by a predefined window, it will not be decoded or output by the scanner. If centering is turned on by scanning **Centering On**, the scanner only reads codes that pass through the centering window you specify using the **Top of Centering Window**, **Bottom of Centering Window**, **Left**, and **Right of Centering Window** barcodes.

Example: In the example below, the white box is the centering window. The centering window has been set to 20% left, 30% right, 8% top, and 25% bottom. Since Barcode 1 passes through the centering window, it will be read. Barcode 2 does not pass through the centering window, so it will not be read.

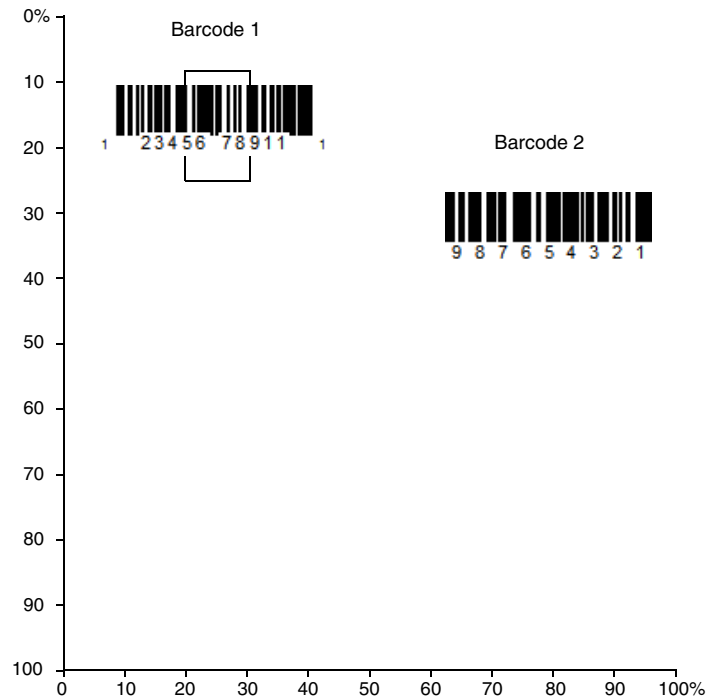

Note: A barcode needs only to be touched by the centering window in order to be read. It does not need to pass completely through the centering window.

Scan **Centering On**, then scan one of the following barcodes to change the top, bottom, left, or right of the centering window. Then scan the percent you want to shift the centering window using digits from the [Programming Chart](#), beginning on page 241, then **Save**. Default Centering = 40% for Top and Left, 60% for Bottom and Right.





DECBOT.

Bottom of Centering Window



DECLFT.

Left of Centering Window



DECRGT.

Right of Centering Window

Preferred Symbology

The scanner can be programmed to specify one symbology as a higher priority over other symbologies in situations where both barcode symbologies appear on the same label, but the lower priority symbology cannot be disabled.

For example, you may be using the scanner in a retail setting to read U.P.C. symbols, but have occasional need to read a code on a drivers license. Since some licenses have a Code 39 symbol as well as the PDF417 symbol, you can use Preferred Symbology to specify that the PDF417 symbol be read instead of the Code 39.

Preferred Symbology classifies each symbology as high priority, low priority, or as an unspecified type. When a low priority symbology is presented, the scanner ignores it for a set period of time (see [Preferred Symbology Time-out](#) on page 57) while it searches for the high priority symbology. If a high priority symbology is located during this period, then that data is read immediately.

If the time-out period expires before a high priority symbology is read, the scanner will read any barcode in its view (low priority or unspecified). If there is no barcode in the scanner's view after the time-out period expires, then no data is reported.

Note: A low priority symbol must be centered on the aiming pattern to be read.

Scan a barcode below to enable or disable Preferred Symbology. *Default = Preferred Symbology Off.*



PRFENA1.

Preferred Symbology On



PRFENA0.

* Preferred Symbology Off

High Priority Symbology

To specify the high priority symbology, scan the **High Priority Symbology** barcode below. On the [Symbology Charts](#) on page 227, find the symbology you want to set as high priority. Locate the Hex value for that symbology and scan the 2 digit hex value from the [Programming Chart](#), beginning on page 241, then **Save**. *Default = None.*



Low Priority Symbology

To specify the low priority symbology, scan the **Low Priority Symbology** barcode below. On the [Symbology Charts](#) on page 227, find the symbology you want to set as low priority. Locate the Hex value for that symbology and scan the 2 digit hex value from the [Programming Chart](#), beginning on page 241.

If you want to set additional low priority symbologies, scan **FF**, then scan the 2 digit hex value from the [Programming Chart](#), beginning on page 241, for the next symbology. You can program up to 5 low priority symbologies. Scan **Save** to save your selection. *Default = None.*



Preferred Symbology Time-out

Once you have enabled Preferred Symbology and entered the high and low priority symbologies, you must set the time-out period. This is the period of time the scanner will search for a high priority barcode after a low priority barcode has been encountered. Scan the barcode below, then set the delay (from 1-3,000 milliseconds) by scanning digits from the [Programming Chart](#), beginning on page 241, then **Save**. *Default = 500 ms.*



Preferred Symbology Default

Scan the barcode below to set all Preferred Symbology entries to their default values.



Output Sequence Overview

Output Sequence Editor

This programming selection allows you to program the scanner to output data (when scanning more than one symbol) in whatever order your application requires, regardless of the order in which the barcodes are scanned. You can define up to 15 barcodes in an output sequence.

Note: To make Output Sequence Editor selections, you'll need to know the code I.D., code length, and character match(es) your application requires. Use the alphanumeric symbols from the [Programming Chart](#), beginning on page 241. You must hold the trigger while reading each barcode in the sequence.

To Add an Output Sequence

An output sequence is created using a string of serial commands that is sent to the scanner. This string is most easily sent to the scanner using the EZConfig software tool (see [EZConfig for Scanning Introduction](#) on page 185). You can also accomplish this by scanning alphanumeric barcodes (see the [Programming Chart](#), beginning on page 241).

1. If you are using barcodes to create your output sequence, scan [Enter Output Sequence](#) on page 62.
2. **Code I.D.**
On the [Symbology Charts](#) on page 227, find the symbology to which you want to apply the output sequence format. Make a note of the hex value for that symbology. If you are using barcodes to create your output sequence, scan the 2 digit hex value from the [Programming Chart](#), beginning on page 241.
3. **Length**
Specify what length (up to 9999 characters) of data output will be acceptable for this symbology. Make a note of the length. If you are using barcodes to create your output sequence, scan the 4 digit data length [Programming Chart](#), beginning on page 241. (Note: 50 characters is entered as **0050**. 9999 is a universal number, indicating all lengths.) When calculating the length, you must count any programmed prefixes, suffixes, or formatted characters as part of the length (unless using 9999).
4. **Character Match Sequences**
On the [ASCII Conversion Chart \(Code Page 1252\)](#), page 230, find the hex value that represents the character(s) you want to match. Make a note of the hex value for the character(s). If you are using barcodes to create your output sequence, use the [Programming Chart](#), beginning on page 241 to read the alphanumeric combination that represents the ASCII characters. (99 is the universal number, indicating all characters.)

5. End Output Sequence Editor

Use **FF** to terminate this string or to begin another output sequence. If you are using barcodes, scan **F F**. Scan **Save** to save your entries.

Other Programming Selections

If you are creating an output sequence using barcodes, scan **Discard** ([page 242](#)) to exit without saving any output sequence changes.

Output Sequence Editor Commands

SEQBLK	Sequence editor start command.
SEQPRE	Add prefix to complete output sequences.
SEQSUF	Add suffix to complete output sequences.
SEQSEP	Add separators to complete output sequences.
SEQTTS1	Transmit partial sequence.
SEQSAT	Define satisfactory subsets of full output sequence.
SEQTIM	Timeout for sequence members when using SEQSAT.
SEQIPR	Add prefix to partial output sequences.
SEQISU	Add suffix to partial output sequences.
SEQISE	Add separators to partial output sequences.
TRGSTO	Timeout for partial output sequences.
FF	Termination string.
SEQ_EN1	Require output sequence on/not required.
SEQ_EN2	Require output sequence required.
BEPSINO	Good read beep - each code in sequence.
BEPSIN1	Good read click - each code in sequence.
BEPISE0	Good read beep - partial sequence output.
BEPISE1	Error tone - partial sequence output.

Examples outlining how to use these commands are shown below:

Output Sequence Example 1 - Three Symbologies



In this example, you are scanning PDF417, Code 128, and Code 39 barcodes, but you want the scanner to output Code 39 first, Code 128 second, and PDF417 third.

Set up the sequence editor with the following command line:

SEQBLK	sequence editor start command
62	code identifier for Code 39
9999	code length that must match for Code 39, 9999 = all lengths
43	start character match for Code 39, 43h = "C"
FF	termination string for first code
6A	code identifier for Code 128
9999	code length that must match for Code 128, 9999 = all lengths
54	start character match for Code 128, 54h = "T"
FF	termination string for first code
72	code identifier for PDF417
9999	code length that must match for PDF417, 9999 = all lengths
4D	start character match for PDF417, 4Dh = "M"
FF	termination string for third code

The whole command line would look like this:

SEQBLK62999943FF6A999954FF7299994DFF.



SEQDFT;SEQ_EN1;SEQBLK6299...

SEQDFT;SEQ_EN1;SEQBLK62999943FF6A999954FF7299994DFF.

The data is output as:

CODE39SMPLTSTMSGCODE128MSGPDF417

Output Sequence Example 2 - Three Symbologies with <> Separators

In this example, you are scanning the same three barcodes, but you want <> brackets and a carriage return and line feed to separate your output.



The sequence editor would use the same command line as shown in [Output Sequence Example 1 - Three Symbologies](#) (page 60):

SEQBLK	sequence editor start command
62	code identifier for Code 39
9999	code length that must match for Code 39, 9999 = all lengths
43	start character match for Code 39, 43h = "C"
FF	termination string for first code
6A	code identifier for Code 128
9999	code length that must match for Code 128, 9999 = all lengths
54	start character match for Code 128, 54h = "T"
FF	termination string for first code
72	code identifier for PDF417
9999	code length that must match for PDF417, 9999 = all lengths
4D	start character match for PDF417, 4Dh = "M"
FF	termination string for third code

But you would add your <> separators for each sequence:

SEQSEP99	separator for each sequence, 99 = all symbologies
3C	left bracket (<)
3E	right bracket (>)

And add the carriage return and line feed as a suffix:

SEQSUF99	separator for suffixes, 99 = all symbologies
OD	carriage return
OA	line feed

The whole command line would look like this:

**SEQBLK62999943FF6A999954FF7299994DFF;SEQSEP993C3E;SEQSUF990D
OA.**



SEQDFT;SEQ_EN1;SEQBLK6299...

SEQDFT;SEQ_EN1;SEQBLK62999943FF6A999954FF7299994DFF;SEQSEP993C3E;SEQSUF990D0A.

The data is output as:

CODE39SMPL<>TSTMSGCODE128<>MSGPDF417 [CR] [LF]

Enter Output Sequence

If you are using barcodes to create your output sequence, scan **Enter Output Sequence** to begin scanning your string.



SEQBLK.

Enter Output Sequence

Partial Sequence

If an output sequence operation is terminated before all your output sequence criteria are met, the barcode data acquired to that point is a “partial sequence.” You can define how partial sequences are output using the same types of command strings you used to create output sequences.

Partial Sequence Example - Three Symbologies with <> Separators, but with a Damaged Code

In this example, you are scanning PDF417, Code 128, and Code 39 barcodes, and you want the scanner to output Code 39 first, Code 128 second, and PDF417 third, in brackets, as shown below, but the Code 39 barcode has been damaged and cannot be output.



MSGPDF417



TSTMSGCODE128



CODE39SMPL

You would use the same command line as shown in [Output Sequence Example 2 - Three Symbolologies with <> Separators](#) (page 61):

SEQBLK	sequence editor start command
62	code identifier for Code 39
9999	code length that must match for Code 39, 9999 = all lengths
43	start character match for Code 39, 43h = "C"
FF	termination string for first code
6A	code identifier for Code 128
9999	code length that must match for Code 128, 9999 = all lengths
54	start character match for Code 128, 54h = "T"
FF	termination string for first code
72	code identifier for PDF417
9999	code length that must match for PDF417, 9999 = all lengths
4D	start character match for PDF417, 4Dh = "M"
FF	termination string for third code

But you would add your <> separators for each sequence:

SEQISE99	separator for each sequence, 99 = all symbolologies
3C	left bracket (<)
3E	right bracket (>)

And add the carriage return and line feed as a suffix:

SEQISU99	separator for suffixes, 99 = all symbolologies
0D	carriage return
0A	line feed

And you would add >**PARTIAL**< as the prefix to note the partial sequence:

SEQTTS1	transmit partial sequence
SEQIPR99	add partial sequence prefix, 99 = all symbologies
3E	right bracket (>)
50	P
41	A
52	R
54	T
49	I
41	A
4C	L
3C	left bracket (<)

The whole command line would look like this:

SEQBLK62999943FF6A999954FF7299994DFF;SEQISE993C3E;SEQISU990DOA;SEQTTS1;SEQIPR993E5041525449414C3C.



SEQDFT;SEQ_EN1;SEQBLK6299...

SEQDFT;SEQ_EN1;SEQBLK62999943FF6A999954FF7299994DFF;SEQISE993C3E;SEQISU990DOA;SEQTTS1;SEQIPR993E5041525449414C3C.

The data is output as:

>PARTIAL<TSTMSGCODE128<>MSGPDF417 [CR] [LF]

Discard Partial Output Sequence

If you want to discard partial sequences when the output sequence operation is terminated before completion, scan **Discard Partial Sequence**.



SEQTTS0.

* Discard Partial Sequence

Output Sequence Timeouts

You can set a timeout for every code in the output sequence defined by the SEQBLK command. The scanner applies the shortest timeout corresponding to any of the codes that have been read during the current trigger session. When the timeout expires, the scanner sends all codes that it has been read in the order they appear in the sequence defined by SEQBLK.

To specify the timeout, use the SEQTIM command followed by a list of timeouts in milliseconds. Each timeout is specified as a 4-decimal digit terminated by FF. The timeout value 9999 is special and indicates that the timeout for that code is “infinite”.

The number of timeouts specified should correspond to the number of codes in the sequence defined by SEQBLK. You can specify one additional timeout, which will apply to codes not matching any member of the sequence. This can be useful if Require Output Sequence is **On/Not Required**. If you do not specify an additional timeout for codes not in the defined sequence, the last timeout specified by SEQTIM will apply.

Output Sequence Timeout Example

For example, if SEQBLK defines a 4-code sequence, you can specify timeouts of 5, 6, 7, and 8 seconds for codes 1-4 respectively using the command **SEQTIM5000FF6000FF7000FF8000FF**. Codes that are not part of the defined sequence would have an implied timeout of 8 seconds in this case (the final timeout in the list). To explicitly specify a timeout for such codes, you can include one more timeout at the end of the list. For example, to include a timeout of 1 second for non-sequence codes, use the command **SEQTIM5000FF6000FF7000FF8000FF1000FF**.

Satisfactory Subset of Full Sequence

You can define one or more subsets of barcodes from the complete sequence specified by SEQBLK. When you scan all the codes from one of these subsets, the scanner will transmit all the codes it has read in the sequence. The scanner sends the codes in the order defined by SEQBLK.

Note: *To use the satisfactory subset feature, you must supply a timeout for each code in the sequence using SEQTIM.*

Satisfactory Subset of Full Sequence Timeout Example

To specify a subset, list its members using the SEQSAT command and terminate each subset with FF. The members of each subset are specified as single hex digits corresponding to their index within the full sequence, 1 being the first. For example, to specify two subsets, the first consisting of the first and second code in the sequence and the second subset consisting of the second and third code, use the command **SEQSAT12FF23FF**.

To define a subset with an odd number of codes, insert a 0 before the final code index. For example, to define a 3-code subset consisting of the first, second, and third codes, use the command **SEQSAT1203FF**.

In this example command **SEQBLK62999943FF6A999954FF7299994DFF** will set the first code in the sequence to Code 39 “C”, second code to Code 128 “T”, and third code to PDF417 “M”.

The command **SEQSAT01FF23FF** will satisfy the sequence if either Position 1 is scanned or Position 2 and 3 are scanned, it will send out the position 1 barcode or Position 2 and 3 barcode right away.



SEQDFT;SEQ_EN1;SEQBLK6299...

SEQDFT;SEQ_EN1;SEQBLK62999943FF6A999954FF7299994DFF;SEQSEP993D3E;SEQSUF990D0A;
SEQSAT01FF23FF;SEQTIM5000FF6000FF7000FF8000FF.

Verify the below combination output sequence:

1. Scan Code 39. Output **CODE39SMPL**
2. Scan Code 128, and then scan Code 39 and wait for timeout. Output **CODE39SMPLTSTMSGCODE128**
3. Scan PDF417, and then scan Code 39 and wait for timeout. Output **CODE39SMPLMSGPDF417**
4. Scan Code 128, and then scan PDF417. Output **TSTMSGCODE128MSGPDF417**
5. Scan PDF417, and then scan Code 128. Output **TSTMSGCODE128MSGPDF417**



SEQDFT;SEQ_EN1;SEQBLK6299...

SEQDFT;SEQ_EN1;SEQBLK62999943FF6A999954FF7299994DFF;SEQSEP993D3E;SEQSUF990D0A;
SEQSAT01FF23FF;SEQTIM5000FF6000FF7000FF8000FF;SEQTTS1.

Verify the combination with SEQTTS1:

1. First scan Code 39. Output **CODE39SMPL**
2. First scan Code 128, and then scan Code 39 and wait for timeout. Output **CODE39SMPLTSTMSGCODE128**
3. First scan PDF417, and then scan Code 39 and wait for timeout. Output **CODE39SMPLMSGPDF417**
4. First scan Code 128, and then scan PDF417. Output **TSTMSGCODE128MSGPDF417**
5. First scan PDF417, and then scan Code 128. Output **TSTMSGCODE128MSGPDF417**

Default Output Sequence

Default Sequence programs the scanner to all universal values. Be certain you want to delete or clear all formats before you read the **Default Sequence** symbol.



Require Output Sequence

When an output sequence is **Required**, all output data must conform to an edited sequence or the scanner will not transmit the output data to the host device. When it's **On/Not Required**, the scanner will attempt to get the output data to conform to an edited sequence but, if it cannot, the scanner transmits all output data to the host device as is, or formatted according to the partial sequence output format (see [Partial Sequence](#) on page 62).

When the output sequence is **Off**, the barcode data is output to the host as the scanner decodes it. *Default = Off.*

Note: *This selection is unavailable when the Multiple Symbols Selection is turned on.*



Good Read Tone - Output Sequences

The scanner may be programmed to either beep or click in response to a good read of each barcode in an output sequence, or to emit a beep or error tone for a partial sequence. *Default = Good Read Click - Each Code in Sequence and Error Tone - Partial Sequence Output.*





BEPISE0.
Good Read Beep - Partial
Sequence Output



BEPSIN1.
* Good Read Click - Each
Code in Sequence



BEPISE1.
* Error Tone - Partial
Sequence Output

Multiple Symbols

When this programming selection is turned **On**, it allows you to read multiple symbols with a single pull of the scanner’s trigger. If you press and hold the trigger, aiming the scanner at a series of symbols, it reads unique symbols once, beeping and or vibrating (if turned on) for each read. The scanner attempts to find and decode new symbols as long as the trigger is pulled. The maximum number of barcodes read is 21. When this programming selection is turned **Off**, the scanner will only read the symbol closest to the aiming beam. *Default = Off.*



SHOTGN1.
On



SHOTGN0.
* Off

No Read

With No Read turned **On**, the scanner notifies you if a code cannot be read. If using an EZConfig-Scanning Tool Scan Data Window (see page 185), an “NR” appears when a code cannot be read. If No Read is turned **Off**, the “NR” will not appear. *Default = Off.*



SHWNRD1.
On



SHWNRD0.
* Off

If you want a different notation than “NR,” for example, “Error,” or “Bad Code,” you can edit the output message (see [Data Format](#) beginning on page 79). The hex code for the No Read symbol is **9C**.

Video Reverse

Video Reverse is used to allow the scanner to read barcodes that are inverted. The **Video Reverse Off** barcode below is an example of this type of barcode. Scan **Video Reverse Only** to read *only* inverted barcodes. Scan **Video Reverse and Standard Barcodes** to read both types of codes.

Note: After scanning **Video Reverse Only**, menu barcodes cannot be read. You must scan **Video Reverse Off** or **Video Reverse and Standard Barcodes** in order to read menu barcodes.

Note: Images downloaded from the unit are not reversed. This is a setting for decoding only.



Working Orientation

Some barcodes are direction-sensitive. For example, KIX codes and OCR can misread when scanned sideways or upside down. Use the working orientation settings if your direction-sensitive codes will not usually be presented upright to the scanner. *Default = Upright.*

Upright:



Upside Down:



Vertical, Top to Bottom:
(Rotate CW 90°)

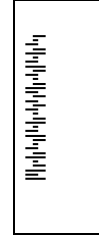

Vertical, Bottom to Top:
(Rotate CCW 90°)



ROTATN0.

* Upright



ROTATN1.

Vertical, Bottom to Top



ROTATN2.

Upside Down



ROTATN3.

Vertical, Top to Bottom

Optimized Scanning for Tobacco Products

Tobacco codes are specialized Dot Code barcodes used on tobacco products in most of Europe and Data Matrix codes used on tobacco products in Russia. The following plug and play commands improve the scanning of these tobacco barcodes.



PAPTBR.

**Optimized Scanning for
Russian Tobacco Products**



PAPTBE.

**Optimized Scanning for
European Tobacco Products**



PAPTBC.

**Optimized Scanning for both
European and Russian
Tobacco Products**

Prefix/Suffix Overview

When a barcode is scanned, additional information is sent to the host computer along with the barcode data. This group of barcode data and additional, user-defined data is called a “message string.” The selections in this section are used to build the user-defined data into the message string.

Prefix and Suffix characters are data characters that can be sent before and after scanned data. You can specify if they should be sent with all symbologies, or only with specific symbologies. The following illustration shows the breakdown of a message string:

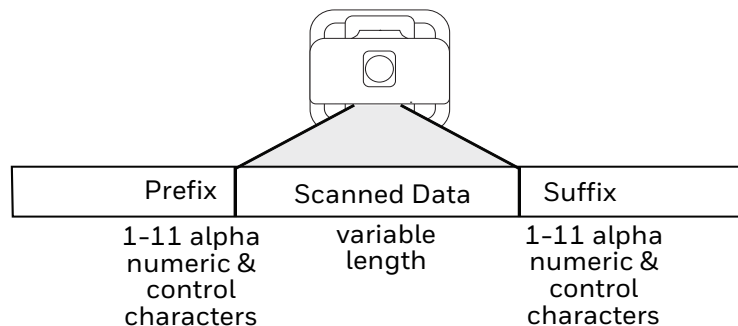

Points to Keep In Mind

- It is not necessary to build a message string. The selections in this chapter are only used if you wish to alter the default settings. *Default prefix = None. Default suffix = None.*
- A prefix or suffix may be added or cleared from one symbology or all symbologies.
- You can add any prefix or suffix from the [ASCII Conversion Chart \(Code Page 1252\)](#), beginning on page 230, plus Code I.D. and AIM I.D.
- You can string together several entries for several symbologies at one time.

- Enter prefixes and suffixes in the order in which you want them to appear on the output.
- When setting up for specific symbologies (as opposed to all symbologies), the specific symbology ID value counts as an added prefix or suffix character.
- The maximum size of a prefix or suffix configuration is 200 characters, which includes header information.

Add a Prefix or Suffix:

- Step 1. Scan the **Add Prefix** or **Add Suffix** symbol ([page 75](#)).
- Step 2. Determine the 2 digit hex value from the [Symbology Charts](#) (beginning on page 227) for the symbology to which you want to apply the prefix or suffix. For example, for Code 128, Code ID is “j” and Hex ID is “6A”.
- Step 3. Scan the 2 hex digits from the [Programming Chart](#), beginning on page 241, or scan **9, 9** for all symbologies.

To add the Code I.D., scan **5, C, 8, 0**.

To add the AIM I.D., scan **5, C, 8, 1**.

To add the serial number, scan **5, C, 8, 8**.

To add a backslash (\), scan **5, C, 5, C**.

Note: *When adding a backslash (\), you must scan 5C twice – once to create the leading backslash and then to create the backslash itself.*

Step 4. Repeat Steps 2 and 3 for every prefix or suffix character.

Step 5. Scan **Save** to exit and save, or scan **Discard** to exit without saving.

Repeat the steps above to add a prefix or suffix for another symbology.

Example: Add a Tab Suffix to All Symbologies

- Step 1. Scan **Add Suffix**.
- Step 2. Scan **9, 9** from the [Programming Chart](#), beginning on page 241 to apply this suffix to all symbologies.
- Step 3. Scan **0, 9** from the [Programming Chart](#), beginning on page 241. This corresponds with the hex value for a horizontal tab, shown in the [ASCII Conversion Chart \(Code Page 1252\)](#), beginning on page 230.
- Step 4. Scan **Save**, or scan **Discard** to exit without saving.

Clear One or All Prefixes or Suffixes

You can clear a single prefix or suffix, or clear all prefixes/suffixes for a symbology. If you have been entering prefixes and suffixes for single symbologies, you can use **Clear One Prefix (Suffix)** to delete a specific character from a symbology. When you **Clear All Prefixes (Suffixes)**, all the prefixes or suffixes for a symbology are deleted.

- Step 1. Scan the **Clear One Prefix** or **Clear One Suffix** symbol.
- Step 2. Determine the 2 digit hex value from the Symbology Chart (included in the [Symbology Charts](#), beginning on page 227) for the symbology from which you want to clear the prefix or suffix.
- Step 3. Scan the 2 digit hex value from the [Programming Chart](#), beginning on page 241 or scan **9, 9** for all symbologies.

Your change is automatically saved.

Add a Carriage Return Suffix to All Symbologies

Scan the following barcode if you wish to add a carriage return suffix to all symbologies at once. This action first clears all current suffixes, then programs a carriage return suffix for all symbologies.



Prefix Selections

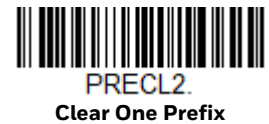

Suffix Selections

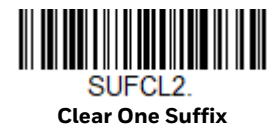



Function Code Transmit

By default, all ASCII control characters are transmitted with barcode data. These non-printable characters are translated into predefined key strokes, or CTRL+X functions (see [ASCII Conversion Chart \(Code Page 1252\)](#), beginning on page 230). If these key strokes interfere with your host's software application, scan **Disable** to keep these ASCII control characters from being transmitted. *Default = Enable.*



Note: You can also use a custom data format (see [Data Format](#) beginning on page 79) to translate these characters into a more meaningful output.

Intercharacter, Interfunction, and Intermessage Delays

Some terminals drop information (characters) if data comes through too quickly. Intercharacter, interfunction, and intermessage delays slow the transmission of data, increasing data integrity.

Intercharacter Delay

An intercharacter delay of up to 5000 milliseconds (in 5ms increments) may be placed between the transmission of each character of scanned data. Scan the **Intercharacter Delay** barcode below, then scan the number of 5ms delays from the [Programming Chart](#), beginning on page 241, then **Save**.

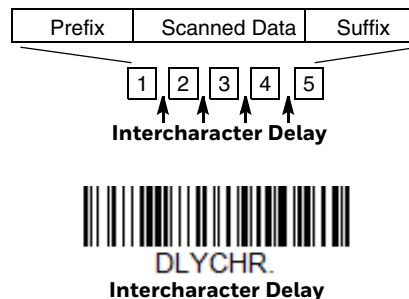

To remove this delay, scan the **Intercharacter Delay** barcode, then set the number of delays to 0. Scan the **Save** barcode from the [Programming Chart](#), beginning on page 241.

Note: *Intercharacter delays are not supported in USB serial emulation.*

User Specified Intercharacter Delay

An intercharacter delay of up to 5000 milliseconds (in 5ms increments) may be placed after the transmission of a particular character of scanned data. Scan the **Delay Length** barcode below, then scan the number of 5ms delays from the [Programming Chart](#), beginning on page 241, then **Save**.

Next, scan the **Character to Trigger Delay** barcode, then the 2-digit hex value for a printable character to trigger the delay (see [Lower ASCII Reference Table](#), page 231.)



To remove this delay, scan the **Delay Length** barcode, and set the number of delays to **0**. Scan the **Save** barcode from the [Programming Chart](#), beginning on page 241.

Interfunction Delay

An interfunction delay of up to 5000 milliseconds (in 5ms increments) may be placed between the transmission of each control character in the message string. Scan the **Interfunction Delay** barcode below, then scan the number of 5ms delays, and the **Save** barcode from the [Programming Chart](#), beginning on page 241.

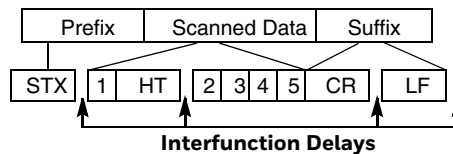

To remove this delay, scan the **Interfunction Delay** barcode, then set the number of delays to 0. Scan the **Save** barcode from the [Programming Chart](#), beginning on page 241.

Intermessage Delay

An intermessage delay of up to 5000 milliseconds (in 5ms increments) may be placed between each scan transmission. Scan the **Intermessage Delay** barcode below, then scan the number of 5ms delays, and the **Save** barcode from the [Programming Chart](#), beginning on page 241.

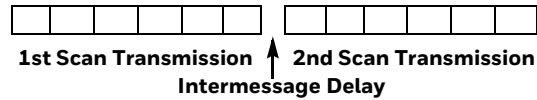

To remove this delay, scan the **Intermessage Delay** barcode, then set the number of delays to **0**. Scan the **Save** barcode from the [Programming Chart](#), beginning on page 241.

Data Format Editor Introduction

You may use the Data Format Editor to change the scanner's output. For example, you can use the Data Format Editor to insert characters at certain points in barcode data as it is scanned. The selections in the following pages are used only if you wish to alter the output. *Default Data Format setting = None.*

Normally, when you scan a barcode, it is output automatically. However, when you create a format, you must use a "send" command (see [Send Commands](#) on page 82) within the format program to output data.

Multiple formats may be programmed into the scanner. They are stacked in the order in which they are entered. However, the following list presents the order in which formats are applied:

1. Specific Terminal ID, Actual Code ID, Actual Length
2. Specific Terminal ID, Actual Code ID, Universal Length
3. Specific Terminal ID, Universal Code ID, Actual Length
4. Specific Terminal ID, Universal Code ID, Universal Length
5. Universal Terminal ID, Actual Code ID, Actual Length
6. Universal Terminal ID, Actual Code ID, Universal Length
7. Universal Terminal ID, Universal Code ID, Actual Length
8. Universal Terminal ID, Universal Code ID, Universal Length

The maximum size of a data format configuration is 2000 bytes, which includes header information.

If a barcode is read that fails the first data format, the next data format, if there is one, will be used on the barcode data. If there is no other data format, the raw data is output.

If you have changed data format settings, and wish to clear all formats and return to the factory defaults, scan the **Default Data Format** code below.



Show Data Format

Scan the barcode below to show current data format settings.



Add a Data Format

- Step 1. Scan the **Enter Data Format** symbol ([page 81](#)).
- Step 2. Select **Primary/Alternate Format**
Determine if this will be your primary data format, or one of 3 alternate formats. This allows you to save a total of 4 different data formats. To program your primary format, scan **0** from the [Programming Chart](#), beginning on page 241. If you are programming an alternate format, scan **1, 2, or 3**, depending on which alternate format you are programming. (See [Primary/Alternate Data Formats](#) on page 97 for further information.)
- Step 3. **Terminal Type**
Refer to [Terminal ID Table](#) (page 82) and locate the Terminal ID number for your PC. Scan three numeric barcodes from the [Programming Chart](#), beginning on page 241, to program the scanner for your terminal ID (you must enter 3 digits). For example, scan **0 0 3** for an AT wedge.

Note: **099** indicates all terminal types.

- Step 4. **Code I.D.**
In the [Symbology Charts](#), beginning on page 227, find the symbology to which you want to apply the data format. Locate the Hex value for that symbology and scan the 2 digit hex value from the [Programming Chart](#), beginning on page 241.

If you wish to create a data format for all symbologies, with the exception of some specific symbologies, refer to B8 ([page 95](#)).

If you are creating a data format for Batch Mode Quantity, use **35** for the Code I.D.

Note: **99** indicates all symbologies.

- Step 5. **Length**
Specify what length (up to 9999 characters) of data will be acceptable for this symbology. Scan the four digit data length from the [Programming](#)

[Chart](#), beginning on page 241. For example, 50 characters is entered as **0050**.

Note: **9999** indicates all lengths.

Step 6. **Editor Commands**

Refer to [Data Format Editor Commands](#) (page 82). Scan the symbols that represent the command you want to enter.

Step 7. Scan **Save** to save your data format, or **Discard** to exit without saving your changes.



Other Programming Selections

- **Clear One Data Format**

This deletes one data format for one symbology. If you are clearing the primary format, scan **0** from the [Programming Chart](#), beginning on page 241. If you are clearing an alternate format, scan **1**, **2**, or **3**, depending on the format you are clearing. Scan the Terminal Type and Code I.D. (see [Symbology Charts](#) on page 227), and the barcode data length for the specific data format that you want to delete. All other formats remain unaffected.

- **Clear all Data Formats**

This clears all data formats.

- **Save**

Exit and save your data format changes.

- **Discard**

Exit without saving any data format changes.





Terminal ID Table

Terminal	Model(s)	Terminal ID
USB	PC keyboard (HID)	124
	Mac Keyboard	125
	PC Keyboard (Japanese)	134
	Serial (COM driver required)	130
	HID POS	131
	USB SurePOS Handheld	128
	USB SurePOS Tabletop	129
	Serial	RS232 TTL
RS232 True		000
RS485 (IBM-HHBCR 1+2, 46xx)		051
Keyboard	PS2 compatibles	003
	AT compatibles	002

Data Format Editor Commands

When working with the Data Format Editor, a virtual cursor is moved along your input data string. The following commands are used to both move this cursor to different positions, and to select, replace, and insert data into the final output.

Send Commands

Send all characters

- F1** Include in the output message all of the characters from the input message, starting from current cursor position, followed by an insert character. *Syntax = F1xx* where xx stands for the insert character's hex value for its ASCII code. Refer to the [ASCII Conversion Chart \(Code Page 1252\)](#), beginning on page 230 for decimal, hex and character codes.

Send a number of characters

F2 Include in the output message a number of characters followed by an insert character. Start from the current cursor position and continue for “nn” characters or through the last character in the input message, followed by character “xx.” Syntax = *F2nnxx* where nn stands for the numeric value (00-99) for the number of characters, and xx stands for the insert character’s hex value for its ASCII code. Refer to the [ASCII Conversion Chart \(Code Page 1252\)](#), beginning on page 230 for decimal, hex and character codes.

F2 Example: Send a number of characters



Send the first 10 characters from the barcode above, followed by a carriage return.
Command string: F2100D

F2 is the “Send a number of characters” command

10 is the number of characters to send

0D is the hex value for a CR

The data is output as: **1234567890**

F2 and F1 Example: Split characters into 2 lines

Send the first 10 characters from the barcode above, followed by a carriage return, followed by the rest of the characters.

Command string: **F2100DF10D**

F2 is the “Send a number of characters” command

10 is the number of characters to send for the first line

0D is the hex value for a CR

F1 is the “Send all characters” command

0D is the hex value for a CR

The data is output as:

1234567890
ABCDEFGHIJ
<CR>

Send all characters up to a particular character

F3 Include in the output message all characters from the input message, starting with the character at the current cursor position and continuing to, but not including, the search character “ss,” followed by an insert character. The cursor is moved forward to the “ss” character. *Syntax = F3ssxx* where ss stands for the search character’s hex value for its ASCII code, and xx stands for the insert character’s hex value for its ASCII code.

Refer to the [ASCII Conversion Chart \(Code Page 1252\)](#), beginning on page 230 for decimal, hex and character codes.

F3 Example: Send all characters up to a particular character



Using the barcode above, send all characters up to but not including “D,” followed by a carriage return.

Command string: **F3440D**

F3 is the “Send all characters up to a particular character” command

44 is the hex value for a 'D’

0D is the hex value for a CR

The data is output as:

**1234567890ABC
<CR>**

Send all characters up to a string

B9 Include in the output message all characters from the input message, starting with the character at the current cursor position and continuing to, but not including, the search string “s...s.” The cursor is moved forward to the beginning of the “s...s” string. *Syntax = B9nnns...s* where nnnn stands for the length of the string, and s...s stands for the string to be matched. The string is made up of hex values for the characters in the string. Refer to the [ASCII Conversion Chart \(Code Page 1252\)](#), beginning on page 230 for decimal, hex and character codes.

B9 Example: Send all characters up to a defined string



Using the barcode above, send all characters up to but not including “AB.”

Command string: **B90024142**

B9 is the “Send all characters up to a string” command

0002 is the length of the string (2 characters)

41 is the hex value for A

42 is the hex value for B

The data is output as: **1234567890**

Send all but the last characters

E9 Include in the output message all but the last “nn” characters, starting from the current cursor position. The cursor is moved forward to one position past the last input message character included. *Syntax = E9nn* where nn stands for the numeric value (00-99) for the number of characters that will not be sent at the end of the message.

Insert a character multiple times

F4 Send “xx” character “nn” times in the output message, leaving the cursor in the current position. *Syntax = F4xxnn* where xx stands for the insert character’s hex value for its ASCII code, and nn is the numeric value (00-99) for the number of times it should be sent. Refer to the [ASCII Conversion Chart \(Code Page 1252\)](#), beginning on page 230 for decimal, hex and character codes.

E9 and F4 Example: Send all but the last characters, followed by 2 tabs



Send all characters except for the last 8 from the barcode above, followed by 2 tabs.

Command string: **E908F40902**

E9 is the “Send all but the last characters” command

08 is the number of characters at the end to ignore

F4 is the “Insert a character multiple times” command

09 is the hex value for a horizontal tab

02 is the number of times the tab character is sent

The data is output as: **1234567890AB <tab><tab>**

Insert a string

BA Send “ss” string of “nn” length in the output message, leaving the cursor in the current position. *Syntax = BAnnnns...s* where nnnn stands for the length of the string, and s...s stands for the string. The string is made up of hex values for the characters in the string. Refer to the [ASCII Conversion Chart \(Code Page 1252\)](#), beginning on page 230 for decimal, hex and character codes.

B9 and BA Example: Look for the string “AB” and insert 2 asterisks ()**



Using the barcode above, send all characters up to but not including “AB.” Insert 2 asterisks at that point, and send the rest of the data with a carriage return after.

Command string: **B900024142BA00022A2AF10D**

B9 is the “Send all characters up to a string” command

0002 is the length of the string (2 characters)

41 is the hex value for A

42 is the hex value for B

BA is the “Insert a string” command

0002 is the length of the string to be added (2 characters)

2A is the hex value for an asterisk (*)

2A is the hex value for an asterisk (*)

F1 is the “Send all characters” command

0D is the hex value for a CR

The data is output as:

1234567890ABCDEFGHIJ**
<CR>

Insert symbology name

- B3** Insert the name of the barcode’s symbology in the output message, without moving the cursor. Only symbologies with a Honeywell ID are included (see [Symbology Charts](#) on page 227). Refer to the [ASCII Conversion Chart \(Code Page 1252\)](#), beginning on page 230 for decimal, hex and character codes.

Insert barcode length

- B4** Insert the barcode’s length in the output message, without moving the cursor. The length is expressed as a numeric string and does not include leading zeros.

B3 and B4 Example: Insert the symbology name and length



Send the symbology name and length before the barcode data from the barcode above. Break up these insertions with spaces. End with a carriage return.

Command string: **B3F42001B4F42001F10D**

B3 is the “Insert symbology name” command
 F4 is the “Insert a character multiple times” command
 20 is the hex value for a space
 01 is the number of times the space character is sent
 B4 is the “Insert barcode length” command
 F4 is the “Insert a character multiple times” command
 20 is the hex value for a space
 01 is the number of times the space character is sent
 F1 is the “Send all characters” command
 0D is the hex value for a CR

The data is output as:
Code128 20 1234567890ABCDEFGHIJ
<CR>

Insert key strokes

B5 Insert a key stroke or combination of key strokes. Key strokes are dependent on your keyboard (see [Keyboard Key References](#) on page 237). Any key can be inserted, including arrows and functions. *Syntax* = 5CB5xxssnn where xx is the number of keys pressed (without key modifiers), ss is the key modifier from the table below, and nn is the key number from the [Keyboard Key References](#), page 237.

Key Modifiers	Hex
No Key Modifier	00
Shift Left	01
Shift Right	02
Alt Left	04
Alt Right	08
Control Left	10
Control Right	20

For example, B501021F inserts an “A” on a 104 key, U.S. style keyboard. B5 = the command, 01 = number of key press events (without the key modifier), 02 is the key modifier for Shift Right, and 1F is the “a” key. If a lower case “a” were to be inserted, B501001F would be entered.

If there are three keystrokes, the syntax would change from B5xxssnn for one keystroke to B5xxssnnssnnssnn. An example that would insert "abc" is as follows: B503001F00320030F833.

Note: Key modifiers can be added together when needed. The sum is converted to hexadecimals.

Example: Control Left+Shift Left = 17, converted to hexadecimal = 11.

Move Commands

Move the cursor forward a number of characters

F5 Move the cursor ahead “nn” characters from current cursor position.
Syntax = F5nn where nn is the numeric value (00-99) for the number of characters the cursor should be moved ahead.

F5 Example: Move the cursor forward and send the data



Move the cursor forward 3 characters, then send the rest of the barcode data from the barcode above. End with a carriage return.

Command string: **F503F10D**

F5 is the “Move the cursor forward a number of characters” command

03 is the number of characters to move the cursor

F1 is the “Send all characters” command

0D is the hex value for a CR

The data is output as:

4567890ABCDEFGHIJ
<CR>

Move the cursor backward a number of characters

F6 Move the cursor back “nn” characters from current cursor position.
Syntax = F6nn where nn is the numeric value (00-99) for the number of characters the cursor should be moved back.

Move the cursor to the beginning

F7 Move the cursor to the first character in the input message. *Syntax = F7.*

FE and F7 Example: Manipulate barcodes that begin with a 1



Search for barcodes that begin with a 1. If a barcode matches, move the cursor back to the beginning of the data and send 6 characters followed by a carriage return. Using the barcode above:

Command string: **FE31F7F2060D**

FE is the “Compare characters” command

31 is the hex value for 1

F7 is the “Move the cursor to the beginning” command

F2 is the “Send a number of characters” command

06 is the number of characters to send

0D is the hex value for a CR

The data is output as:

123456

<CR>

Move the cursor to the end

EA Move the cursor to the last character in the input message. *Syntax = EA.*

Search Commands

Search forward for a character

F8 Search the input message forward for “xx” character from the current cursor position, leaving the cursor pointing to the “xx” character. *Syntax = F8xx* where xx stands for the search character’s hex value for its ASCII code. Refer to the [ASCII Conversion Chart \(Code Page 1252\)](#), beginning on page 230 for decimal, hex and character codes.

F8 Example: Send barcode data that starts after a particular character



Search for the letter “D” in barcodes and send all the data that follows, including the “D.” Using the barcode above:

Command string: **F844F10D**

F8 is the “Search forward for a character” command

44 is the hex value for “D”

F1 is the “Send all characters” command

0D is the hex value for a CR

The data is output as:

DEFGHIJ
<CR>

Search backward for a character

- F9** Search the input message backward for “xx” character from the current cursor position, leaving the cursor pointing to the “xx” character. *Syntax = F9xx* where xx stands for the search character’s hex value for its ASCII code. Refer to the [ASCII Conversion Chart \(Code Page 1252\)](#), beginning on page 230 for decimal, hex and character codes.

Search forward for a string

- B0** Search forward for “s” string from the current cursor position, leaving cursor pointing to “s” string. *Syntax = B0nnnnS* where nnnn is the string length (up to 9999), and S consists of the ASCII hex value of each character in the match string. For example, B0000454657374 will search forward for the first occurrence of the 4 character string “Test.” Refer to the [ASCII Conversion Chart \(Code Page 1252\)](#), beginning on page 230 for decimal, hex and character codes.

B0 Example: Send barcode data that starts after a string of characters



Search for the letters “FGH” in barcodes and send all the data that follows, including “FGH.” Using the barcode above:

Command string: **B00003464748F10D**

B0 is the “Search forward for a string” command

0003 is the string length (3 characters)

46 is the hex value for “F”

47 is the hex value for “G”

48 is the hex value for “H”

F1 is the “Send all characters” command

0D is the hex value for a CR

The data is output as:

FGHIJ
<CR>

Search backward for a string

B1 Search backward for “s” string from the current cursor position, leaving cursor pointing to “s” string. Syntax = B1nnnnS where nnnn is the string length (up to 9999), and S consists of the ASCII hex value of each character in the match string. For example, B1000454657374 will search backward for the first occurrence of the 4 character string “Test.”

Refer to the [ASCII Conversion Chart \(Code Page 1252\)](#), beginning on page 230 for decimal, hex and character codes.

Search forward for a non-matching character

E6 Search the input message forward for the first non-“xx” character from the current cursor position, leaving the cursor pointing to the non-“xx” character. Syntax = E6xx where xx stands for the search character’s hex value for its ASCII code. Refer to the [ASCII Conversion Chart \(Code Page 1252\)](#), beginning on page 230 for decimal, hex and character codes.

E6 Example: Remove zeros at the beginning of barcode data



This example shows a barcode that has been zero filled. You may want to ignore the zeros and send all the data that follows. E6 searches forward for the first character that is not zero, then sends all the data after, followed by a carriage return. Using the barcode above:

Command string: **E630F10D**

E6 is the “Search forward for a non-matching character” command

30 is the hex value for 0

F1 is the “Send all characters” command

0D is the hex value for a CR

The data is output as:

37692

<CR>

Search backward for a non-matching character

E7 Search the input message backward for the first non-“xx” character from the current cursor position, leaving the cursor pointing to the non-“xx” character. Syntax = E7xx where xx stands for the search character’s hex value for its ASCII code. Refer to the [ASCII Conversion Chart \(Code Page 1252\)](#), beginning on page 230 for decimal, hex and character codes.

Miscellaneous Commands

Suppress characters

FB Suppress all occurrences of up to 15 different characters, starting at the current cursor position, as the cursor is advanced by other commands. When the FC command is encountered, the suppress function is terminated. The cursor is not moved by the FB command.

Syntax = FBnnxxyy ..zz where nn is a count of the number of suppressed characters in the list, and xxyy ..zz is the list of characters to be suppressed.

FB Example: Remove spaces in barcode data



This example shows a barcode that has spaces in the data. You may want to remove the spaces before sending the data. Using the barcode above:

Command string: **FB0120F10D**

FB is the “Suppress characters” command

01 is the number of character types to be suppressed

20 is the hex value for a space

F1 is the “Send all characters” command

0D is the hex value for a CR

The data is output as:

34567890

<CR>

Stop suppressing characters

FC Disables suppress filter and clear all suppressed characters. *Syntax = FC.*

Replace characters

E4 Replaces up to 15 characters in the output message, without moving the cursor. Replacement continues until the E5 command is encountered. *Syntax = E4nnxx₁xx₂yy₁yy₂...zz₁zz₂* where nn is the total count of the number of characters in the list (characters to be replaced plus replacement characters); xx₁ defines characters to be replaced and xx₂ defines replacement characters, continuing through zz₁ and zz₂.

E4 Example: Replace zeros with CRs in barcode data



If the barcode has characters that the host application does not want included, you can use the E4 command to replace those characters with something else. In this example, you will replace the zeros in the barcode above with carriage returns.

Command string: **E402300DF10D**

E4 is the “Replace characters” command

02 is the total count of characters to be replaced, plus the replacement characters (0 is replaced by CR, so total characters = 2)

30 is the hex value for 0

0D is the hex value for a CR (the character that will replace the 0)

F1 is the “Send all characters” command

0D is the hex value for a CR

The data is output as:

1234

5678

ABC

<CR>

Stop replacing characters

E5 Terminates character replacement. *Syntax = E5.*

Compare characters

FE Compare the character in the current cursor position to the character “xx.” If characters are equal, move the cursor forward one position. *Syntax = FExx* where xx stands for the comparison character’s hex value for its ASCII code.

Refer to the [ASCII Conversion Chart \(Code Page 1252\)](#), beginning on page 230 for decimal, hex and character codes.

Compare string

B2 Compare the string in the input message to the string “s.” If the strings are equal, move the cursor forward past the end of the string. *Syntax = B2nnnnS* where nnnn is the string length (up to 9999), and S consists of the ASCII hex value of each character in the match string. For example, B2000454657374 will compare the string at the current cursor position with the 4 character string “Test.”

Refer to the [ASCII Conversion Chart \(Code Page 1252\)](#), beginning on page 230 for decimal, hex and character codes.

Check for a number

EC Check to make sure there is an ASCII number at the current cursor position. The format is aborted if the character is not numeric.

EC Example: Only output the data if the barcode begins with a number

If you want only data from barcodes that begin with a number, you can use EC to check for the number.

Command string: **ECF10D**

EC is the “Check for a number” command

F1 is the “Send all characters” command

0D is the hex value for a CR

If this barcode is read,  the next data format, if there is one, will be used on the data. If there is no other format, the format fails and the raw data is output as **AB1234**.

If this barcode is read:  the data is output as:

1234AB
<CR>

Check for non-numeric character

ED Check to make sure there is a non-numeric ASCII character at the current cursor position. The format is aborted if the character is numeric.

ED Example: Only output the data if the barcode begins with a letter

If you want only data from barcodes that begin with a letter, you can use ED to check for the letter.

Command string: **EDF10D**

ED is the “Check for a non-numeric character” command

F1 is the “Send all characters” command

0D is the hex value for a CR

If this barcode is read,  the next data format, if there is one, will be used on this data. If there is no other format, the format fails and the raw data is output as **1234AB**.

If this barcode is read:  the data is output as:

AB1234
<CR>

Insert a delay

EF Inserts a delay of up to 49,995 milliseconds (in multiples of 5), starting from the current cursor position. Syntax = EFnnnn where nnnn stands for the delay in 5ms increments, up to 9999. This command can only be used with keyboard emulation.

Discard Data

B8 Discards types of data. For example, you may want to discard Code 128 barcodes that begin with the letter A. In step 4 ([page 80](#)), select 6A (for Code 128), and in step 5, select 9999 (for all lengths). Enter FE41B8 to compare and discard Code 128 barcodes that begin with the letter A. Syntax = B8.

Note: The B8 command must be entered after all other commands.

The Data Format must be **Required** (see [page 95](#)) in order for the B8 command to work.

If Data Format is On, but Not Required ([page 96](#)), barcode data that meets the B8 format is scanned and output as usual.

Because the data format needs to be **On** and **Required** ([page 96](#)) for the B8 command, you must input data formats for all barcodes you wish to discard as well as all barcodes you wish to output.

Other data format settings impact the B8 command. If Data Format Non-Match Error Tone is On ([page 96](#)), the scanner emits an error tone. If Data format Non-Match Error Tone is Off, the code is disabled for reading and no tone is sounded.

Data Formatter

When Data Formatter is turned Off, the barcode data is output to the host as read, including prefixes and suffixes.



You may wish to require the data to conform to a data format you have created and saved. The following settings can be applied to your data format:

- **Data Formatter On, Not Required, Keep Prefix/Suffix**
Scanned data is modified according to your data format, and prefixes and suffixes are transmitted.
- **Data Formatter On, Not Required, Drop Prefix/Suffix**
Scanned data is modified according to your data format. If a data format is found for a particular symbol, those prefixes and suffixes are not transmitted. If a data format is *not* found for that symbol, the prefixes and suffixes are transmitted.
- **Data Format Required, Keep Prefix/Suffix**
Scanned data is modified according to your data format, and prefixes and suffixes are transmitted. Any data that does not match your data format

requirements generates an error tone and the data in that barcode is not transmitted. If you wish to process this type of barcode without generating an error tone, see [Data Format Non-Match Error Tone](#).

- **Data Format Required, Drop Prefix/Suffix**
Scanned data is modified according to your data format. If a data format is found for a particular symbol, those prefixes and suffixes are not transmitted. Any data that does not match your data format requirements generates an error tone. If you wish to process this type of barcode without generating an error tone, see [Data Format Non-Match Error Tone](#).

Choose one of the following options. *Default = Data Formatter On, Not Required, Keep Prefix/Suffix.*



DFM_EN1.

* Data Formatter On,
Not Required,
Keep Prefix/Suffix



DFM_EN3.

Data Formatter On,
Not Required,
Drop Prefix/Suffix



DFM_EN2.

Data Format Required,
Keep Prefix/Suffix



DFM_EN4.

Data Format Required,
Drop Prefix/Suffix

Data Format Non-Match Error Tone

When a barcode is encountered that doesn't match your required data format, the scanner normally generates an error tone. However, you may want to continue scanning barcodes without hearing the error tone. If you scan the **Data Format Non-Match Error Tone Off** barcode, data that doesn't conform to your data format is not transmitted, and no error tone will sound. If you wish to hear the error tone when a non-matching barcode is found, scan the **Data Format Non-Match Error Tone On** barcode. *Default = Data Format Non-Match Error Tone On.*



DFMDEC0.

* Data Format Non-Match Error
Tone On



Primary/Alternate Data Formats

You can save up to four data formats, and switch between these formats. Your primary data format is saved under **0**. Your other three formats are saved under **1**, **2**, and **3**. To set your device to use one of these formats, scan one of the barcodes below.



Single Scan Data Format Change

You can also switch between data formats for a single scan. The next barcode is scanned using an alternate data format, then reverts to the format you have selected above (either Primary, 1, 2, or 3).

For example, you may have set your device to the data format you saved as Data Format 3. You can switch to Data Format 1 for a single trigger pull by scanning the **Single Scan-Data Format 1** barcode below. The next barcode that is scanned uses Data Format 1, then reverts back to Data Format 3.

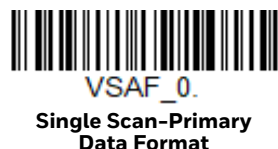



VSAF_2.

Single Scan-Data Format 2



VSAF_1.

Single Scan-Data Format 1



VSAF_3.

Single Scan-Data Format 3

SYMBOLOLOGIES

This programming section contains the following menu selections. Refer to [Chapter 9](#) for settings and defaults.

- All Symbolologies
- Aztec Code
- China Post (Hong Kong 2 of 5)
- Chinese Sensible (Han Xin) Code
- Codabar
- Codablock A
- Codablock F
- Code 11
- Code 128
- Code 32 Pharmaceutical (PARAF)
- Code 39
- Code 93
- Data Matrix
- Digimarc Barcode™
- DotCode
- EAN/JAN-13
- EAN/JAN-8
- GS1 Composite Codes
- GS1 DataBar Expanded
- GS1 DataBar Limited
- GS1 DataBar Omnidirectional
- GS1 Emulation
- GS1-128
- Interleaved 2 of 5
- Korea Post
- Label Code
- Matrix 2 of 5
- MaxiCode
- MicroPDF417
- MSI
- NEC 2 of 5
- Postal Codes - 2D
- Postal Codes - Linear
- PDF417
- QR Code
- Straight 2 of 5 IATA (two-bar start/stop)
- Straight 2 of 5 Industrial (three-bar start/stop)
- TCIF Linked Code 39 (TLC39)
- Telepen
- Trioptic Code
- UPC-A
- UPC-A/EAN-13 with Extended Coupon Code
- UPC-E0
- UPC-E1

All Symbologies

For best scanner performance, you should only enable the symbologies that you need. Scan **All Symbologies Off** to disable all symbologies, then enable the symbologies you need by scanning the **On** barcode for each symbology.



Message Length Description

You are able to set the valid reading length of some of the barcode symbologies. You may wish to set the same value for minimum and maximum length to force the scanner to read fixed length barcode data. This helps reduce the chances of a misread.

Example: Decode only those barcodes with a count of 9-20 characters.
Min. length = 09
Max. length = 20

Example: Decode only those barcodes with a count of 15 characters.
Min. length = 15
Max. length = 15

For a value other than the minimum and maximum message length defaults, scan the barcodes included in the explanation of the symbology, then scan the digit value of the message length and **Save** barcodes from the [Programming Chart](#), beginning on page 241. The minimum and maximum lengths and the defaults are included with the respective symbologies.

Codabar

<Default All Codabar Settings>



Codabar On/Off

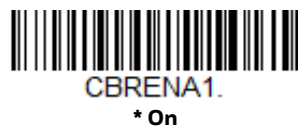



Codabar Start / Stop Characters

Start/Stop characters identify the leading and trailing ends of the barcode. You may either transmit, or not transmit Start/Stop characters. *Default = Don't Transmit.*



Codabar Check Character

Codabar check characters are created using different “modulos.” You can program the scanner to read only Codabar barcodes with Modulo 16 check characters. *Default = No Check Character.*

No Check Character indicates that the scanner reads and transmits barcode data with or without a check character.

When Check Character is set to **Validate and Transmit**, the scanner will only read Codabar barcodes printed with a check character, and will transmit this character at the end of the scanned data.

When Check Character is set to **Validate, but Don't Transmit**, the unit will only read Codabar barcodes printed *with* a check character, but will not transmit the check character with the scanned data.



Codabar Concatenation

Codabar supports symbol concatenation. When you enable concatenation, the scanner looks for a Codabar symbol having a “D” start character, adjacent to a symbol having a “D” stop character. In this case the two messages are concatenated into one with the “D” characters omitted.



Select **Require** to prevent the scanner from decoding a single “D” Codabar symbol without its companion. This selection has no effect on Codabar symbols without Stop/Start D characters.



Codabar Message Length

Scan the barcodes below to change the message length. Refer to [Message Length Description](#) (page 100) for additional information. Minimum and Maximum lengths = 2-60. Minimum Default = 4, Maximum Default = 60.



Code 39

< Default All Code 39 Settings >



Code 39 On/Off



If you are reading Code 39 barcodes, Codablock A should remain disabled. If you are enabling Codablock A (see [Codablock A](#) on page 139), you should disable Code 39.

Code 39 Start/Stop Characters

Start/Stop characters identify the leading and trailing ends of the barcode. You may either transmit, or not transmit Start/Stop characters. *Default = Don't Transmit.*



Code 39 Check Character

No Check Character indicates that the scanner reads and transmits barcode data with or without a check character.

When Check Character is set to **Validate, but Don't Transmit**, the unit only reads Code 39 barcodes printed with a check character, but will not transmit the check character with the scanned data.

When Check Character is set to **Validate and Transmit**, the scanner only reads Code 39 barcodes printed with a check character, and will transmit this character at the end of the scanned data. *Default = No Check Character.*



C39CK20.
* No Check Character



C39CK21.
Validate, but Don't Transmit



C39CK22.
Validate and Transmit

Code 39 Message Length

Scan the barcodes below to change the message length. Refer to [Message Length Description](#) (page 100) for additional information. Minimum and Maximum lengths = 0-48. Minimum Default = 0, Maximum Default = 48.



C39MIN.
Minimum Message Length



C39MAX.
Maximum Message Length

Code 39 Append

This function allows the scanner to append the data from several Code 39 barcodes together before transmitting them to the host computer. When the scanner encounters a Code 39 barcode with the append trigger character(s), it buffers Code 39 barcodes until it reads a Code 39 barcode that does not have the append trigger. The data is then transmitted in the order in which the barcodes were read (FIFO). *Default = Off.*



C39APP1.
On



C39APP0.
* Off

Code 32 Pharmaceutical (PARAF)

Code 32 Pharmaceutical is a form of the Code 39 symbology used by Italian pharmacies. This symbology is also known as PARAF.

Note: *Trioptic Code (page 139) must be turned off while scanning Code 32 Pharmaceutical codes.*



Full ASCII

If Full ASCII Code 39 decoding is enabled, certain character pairs within the barcode symbol will be interpreted as a single character. For example: \$V will be decoded as the ASCII character SYN, and /C will be decoded as the ASCII character #. *Default = Off.*

Full ASCII Table											
NUL %U	DLE \$P	SP SPACE	0 0	@ %V	P P	' %W	p +P				
SOH \$A	DC1 \$Q	! /A	1 1	A A	Q Q	a +A	q +Q				
STX \$B	DC2 \$R	" /B	2 2	B B	R R	b +B	r +R				
ETX \$C	DC3 \$S	# /C	3 3	C C	S S	c +C	s +S				
EOT \$D	DC4 \$T	\$ /D	4 4	D D	T T	d +D	t +T				
ENQ \$E	NAK \$U	% /E	5 5	E E	U U	e +E	u +U				
ACK \$F	SYN \$V	& /F	6 6	F F	V V	f +F	v +V				
BEL \$G	ETB \$W	' /G	7 7	G G	W W	g +G	w +W				
BS \$H	CAN \$X	(/H	8 8	H H	X X	h +H	x +X				
HT \$I	EM \$Y) /I	9 9	I I	Y Y	i +I	y +Y				
LF \$J	SUB \$Z	* /J	:	/Z	J J	Z Z	j +J	z +Z			
VT \$K	ESC %A	+ /K	;	%F	K K	[%K	k +K	{ %P			
FF \$L	FS %B	, /L	<	%G	L L	\ %L	l +L	%Q			
CR \$M	GS %C	- -	=	%H	M M] %M	m +M	} %R			
SO \$N	RS %D	. .	>	%I	N N	^ %N	n +N	~ %S			
SI \$O	US %E	/ /O	?	%J	O O	_ %O	o +O	DEL %T			

Character pairs /M and /N decode as a minus sign and period respectively.
Character pairs /P through /Y decode as 0 through 9.





Code 39 Code Page

Code pages define the mapping of character codes to characters. If the data received does not display with the proper characters, it may be because the barcode being scanned was created using a code page that is different from the one the host program is expecting. If this is the case, scan the barcode below, select the code page with which the barcodes were created (see [ISO 2022/ISO 646 Character Replacements](#) on page 234), and scan the value and the **Save** barcode from the [Programming Chart](#), beginning on page 241. The data characters should then appear properly.



Interleaved 2 of 5

< Default All Interleaved 2 of 5 Settings >



Interleaved 2 of 5 On/Off



Check Digit

No Check Digit indicates that the scanner reads and transmits barcode data with or without a check digit.

When Check Digit is set to **Validate, but Don't Transmit**, the unit only reads Interleaved 2 of 5 barcodes printed with a check digit, but will not transmit the check digit with the scanned data.

When Check Digit is set to **Validate and Transmit**, the scanner only reads Interleaved 2 of 5 barcodes printed with a check digit, and will transmit this digit at the end of the scanned data. *Default = No Check Digit.*



Interleaved 2 of 5 Message Length

Scan the barcodes below to change the message length. Refer to [Message Length Description](#) (page 100) for additional information. Minimum and Maximum lengths = 2-80. Minimum Default = 6, Maximum Default = 80.



FEBRABAN Decode

Scan the barcodes below to turn FEBRABAN Boleto decoding on or off. *Default = Off.*



NEC 2 of 5

< Default All NEC 2 of 5 Settings >



NEC 2 of 5 On/Off



Check Digit

No Check Digit indicates that the scanner reads and transmits barcode data with or without a check digit.

When Check Digit is set to **Validate, but Don't Transmit**, the unit only reads NEC 2 of 5 barcodes printed with a check digit, but will not transmit the check digit with the scanned data.

When Check Digit is set to **Validate and Transmit**, the scanner only reads NEC 2 of 5 barcodes printed with a check digit, and will transmit this digit at the end of the scanned data. *Default = No Check Digit.*



NEC 2 of 5 Message Length

Scan the barcodes below to change the message length. Refer to [Message Length Description](#) (page 100) for additional information. Minimum and Maximum lengths = 2-80. Minimum Default = 4, Maximum Default = 80.



Code 93

< Default All Code 93 Settings >



Code 93 On/Off



Code 93 Message Length

Scan the barcodes below to change the message length. Refer to [Message Length Description](#) (page 100) for additional information. Minimum and Maximum lengths = 0-80. Minimum Default = 0, Maximum Default = 80.



Code 93 Append

This function allows the scanner to append the data from several Code 93 barcodes together before transmitting them to the host computer. When this function is enabled, the scanner stores those Code 93 barcodes that start with a space (excluding the start and stop symbols), and does not immediately transmit the data. The scanner stores the data in the order in which the barcodes are read, deleting the first space from each. The scanner transmits the appended data when it reads a Code 93 barcode that starts with a character other than a space. *Default = Off.*



C93APP1.

On



C93APP0.

* Off

Code 93 Code Page

Code pages define the mapping of character codes to characters. If the data received does not display with the proper characters, it may be because the barcode being scanned was created using a code page that is different from the one the host program is expecting. If this is the case, scan the barcode below, select the code page with which the barcodes were created (see [ISO 2022/ISO 646 Character Replacements](#) on page 234), and scan the value and the **Save** barcode from the [Programming Chart](#), beginning on page 241. The data characters should then appear properly.



C93DCP.

Code 93 Code Page

Straight 2 of 5 Industrial (three-bar start/stop)

<Default All Straight 2 of 5 Industrial Settings>



R25DFT.

Straight 2 of 5 Industrial On/Off



R25ENA1.

On



R25ENA0.

* Off

Straight 2 of 5 Industrial Message Length

Scan the barcodes below to change the message length. Refer to [Message Length Description](#) (page 100) for additional information. Minimum and Maximum lengths = 1-48. Minimum Default = 4, Maximum Default = 48.



R25MIN.

Minimum Message Length



R25MAX.

Maximum Message Length

Straight 2 of 5 IATA (two-bar start/stop)

<Default All Straight 2 of 5 IATA Settings>



Straight 2 of 5 IATA On/Off



Straight 2 of 5 IATA Redundancy

If you are encountering errors when reading Straight 2 of 5 IATA barcodes, you may want to adjust the redundancy count. Redundancy adjusts the number of times a barcode is decoded before transmission, which may reduce the number of errors. Note that the higher the redundancy count, the longer it will take to decode the barcode. To adjust the redundancy, scan the Straight 2 of 5 IATA Redundancy barcode below, then scan a redundancy count between 0 and 10 on the [Programming Chart](#), beginning on page 241. Then scan the **Save** barcode. *Default = 0.*



Straight 2 of 5 IATA Message Length

Scan the barcodes below to change the message length. Refer to [Message Length Description](#) (page 100) for additional information. Minimum and Maximum lengths = 1-48. Minimum Default = 4, Maximum Default = 48.





Matrix 2 of 5

<Default All Matrix 2 of 5 Settings>



Matrix 2 of 5 On/Off



Matrix 2 of 5 Message Length

Scan the barcodes below to change the message length. Refer to [Message Length Description](#) (page 100) for additional information. Minimum and Maximum lengths = 1-80. Minimum Default = 4, Maximum Default = 80.



Code 11

<Default All Code 11 Settings>



Code 11 On/Off



Check Digits Required

This option sets whether 1 or 2 check digits are required with Code 11 barcodes.
Default = Two Check Digits.



Code 11 Message Length

Scan the barcodes below to change the message length. Refer to [Message Length Description](#) (page 100) for additional information. Minimum and Maximum lengths = 1-80. Minimum Default = 4, Maximum Default = 80.



Code 128

<Default All Code 128 Settings>



Code 128 On/Off



If you are reading Code 128 barcodes, Codablock F should remain disabled. If you are enabling Codablock F (see [Codablock F](#) on page 140), you should disable Code 128.

ISBT 128 Concatenation

In 1994 the International Society of Blood Transfusion (ISBT) ratified a standard for communicating critical blood information in a uniform manner. The use of ISBT formats requires a paid license. The ISBT 128 Application Specification describes 1) the critical data elements for labeling blood products, 2) the current recommendation to use Code 128 due to its high degree of security and its space-efficient design, 3) a variation of Code 128 that supports concatenation of neighboring symbols, and 4) the standard layout for barcodes on a blood product label. Use the barcodes below to turn concatenation on or off. *Default =Off.*



Code 128 Redundancy

If you are encountering errors when reading Code 128 barcodes, you may want to adjust the redundancy count. Redundancy adjusts the number of times a barcode is decoded before transmission, which may reduce the number of errors. Note that

the higher the redundancy count, the longer it will take to decode the barcode. To adjust the redundancy, scan the Code 128 Redundancy barcode below, then scan a redundancy count between 0 and 10 on the [Programming Chart](#), beginning on page 241. Then scan the **Save** barcode. *Default = 0.*



128VOT.

Code 128 Redundancy

Code 128 Message Length

Scan the barcodes below to change the message length. Refer to [Message Length Description](#) (page 100) for additional information. Minimum and Maximum lengths = 0-80. Minimum Default = 0, Maximum Default = 80.



128MIN.

Minimum Message Length



128MAX.

Maximum Message Length

Code 128 Append

This function allows the scanner to append the data from several Code 128 barcodes together before transmitting them to the host computer. When the scanner encounters a Code 128 barcode with the append trigger character(s), it buffers Code 128 barcodes until it reads a Code 128 barcode that does not have the append trigger. The data is then transmitted in the order in which the barcodes were read (FIFO). *Default = Off.*



128APP1.

On



128APP0.

*** Off**

Code 128 Code Page

Code pages define the mapping of character codes to characters. If the data received does not display with the proper characters, it may be because the barcode being scanned was created using a code page that is different from the one the host program is expecting. If this is the case, scan the barcode below, select the code page with which the barcodes were created (see [ISO 2022/ISO 646](#)

Character Replacements on page 234), and scan the value and the **Save** barcode from the [Programming Chart](#), beginning on page 241. The data characters should then appear properly.



GS1-128

<Default All GS1-128 Settings>



GS1-128 On/Off



GS1-128 Message Length

Scan the barcodes below to change the message length. Refer to [Message Length Description](#) (page 100) for additional information. Minimum and Maximum lengths = 1-80. Minimum Default = 1, Maximum Default = 80.



Telepen

<Default All Telepen Settings>



Telepen On/Off



Telepen Output

Using **AIM Telepen Output**, the scanner reads symbols with start/stop pattern 1 and decodes them as standard full ASCII (start/stop pattern 1). When **Original Telepen Output** is selected, the scanner reads symbols with start/stop pattern 1 and decodes them as compressed numeric with optional full ASCII (start/stop pattern 2). *Default = AIM Telepen Output.*



Telepen Message Length

Scan the barcodes below to change the message length. Refer to [Message Length Description](#) (page 100) for additional information. Minimum and Maximum lengths = 1-60. Minimum Default = 1, Maximum Default = 60.



UPC-A

<Default All UPC-A Settings>



UPC-A On/Off

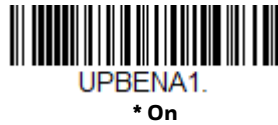

Note: To convert UPC-A barcodes to EAN-13, see [Convert UPC-A to EAN-13](#) on page 126.

UPC-A Check Digit

This selection allows you to specify whether the check digit should be transmitted at the end of the scanned data or not. *Default = On.*



UPC-A Number System

The numeric system digit of a U.P.C. symbol is normally transmitted at the beginning of the scanned data, but can be programmed so it is not transmitted (**Off**). *Default = On.*



UPC-A Addenda

This selection adds 2 or 5 digits to the end of all scanned UPC-A data. *Default = Off for both 2 Digit and 5 Digit Addenda.*



UPC-A Addenda Required

When **Required** is scanned, the scanner will only read UPC-A barcodes that have addenda. You must then turn on a 2 or 5 digit addenda listed on [page 120](#). *Default = Not Required.*





UPAARQ0.
* Not Required

Addenda Timeout

You can set a time during which the scanner looks for an addenda. If an addenda is not found within this time period, the data can be either transmitted or discarded, based on the setting you are using for [UPC-A Addenda Required](#). Set the length (in milliseconds) for this timeout by scanning the barcode below, then setting the timeout (from 0-500 milliseconds) by scanning digits from the [Programming Chart](#), beginning on page 241 of this manual, then **Save**. *Default = 120.*

Note: *The Addenda Timeout setting is applied to all addenda and coupon code searches.*



DLYADD.
Addenda Timeout

UPC-A Addenda Separator

When this feature is **On**, there is a space between the data from the barcode and the data from the addenda. When turned **Off**, there is no space. *Default = On.*



UPAADS1.
* On



UPAADS0.
Off

UPC-A/EAN-13 with Extended Coupon Code

Use the following codes to enable or disable UPC-A and EAN-13 with Extended Coupon Code. When left on the default setting (**Off**), the scanner treats Coupon Codes and Extended Coupon Codes as single barcodes.

If you scan the **Allow Concatenation** code, when the scanner sees the coupon code and the extended coupon code in a single scan, it transmits both as one symbologies. Otherwise, it transmits the first coupon code it reads.

If you scan the **Require Concatenation** code, the scanner must see and read the coupon code and extended coupon code in a single read to transmit the data. No data is output unless both codes are read. *Default = Off.*



Addenda Timeout

You can set a time during which the scanner looks for an addenda. If an addenda is not found within this time period, the data can be either transmitted or discarded, based on the setting you are using for [UPC-A/EAN-13 with Extended Coupon Code](#). Set the length (in milliseconds) for this timeout by scanning the barcode below, then setting the timeout (from 0-500 milliseconds) by scanning digits from the [Programming Chart](#), beginning on page 241 of this manual, then **Save**. *Default = 120.*

Note: *The Addenda Timeout setting is applied to all addenda and coupon code searches.*



Coupon GS1 DataBar Output

If you scan coupons that have both UPC and GS1 Databar codes, you may wish to scan and output only the data from the GS1 Databar code. Scan the **GS1 Output On** code below to scan and output only the GS1 Databar code data. *Default = GS1 Output Off.*



UPC-E0

<Default All UPC-E Settings>



UPC-E0 On/Off

Most U.P.C. barcodes lead with the 0 number system. To read these codes, use the **UPC-E0 On** selection. If you need to read codes that lead with the 1 number system, use **UPC-E1** (page 125). *Default = On.*



UPC-E0 Expand

UPC-E Expand expands the UPC-E code to the 12 digit, UPC-A format. *Default = Off.*



UPC-E0 Addenda Required

When **Required** is scanned, the scanner will only read UPC-E barcodes that have addenda. *Default = Not Required.*



Addenda Timeout

You can set a time during which the scanner looks for an addenda. If an addenda is not found within this time period, the data can be either transmitted or discarded, based on the setting you are using for [UPC-E0 Addenda Required](#). Set the length (in milliseconds) for this timeout by scanning the barcode below, then setting the timeout (from 0-500 milliseconds) by scanning digits from the [Programming Chart](#), beginning on page 241 of this manual, then **Save**. *Default = 120.*

Note: *The Addenda Timeout setting is applied to all addenda and coupon code searches.*



DLYADD.
Addenda Timeout

UPC-E0 Addenda Separator

When this feature is **On**, there is a space between the data from the barcode and the data from the addenda. When turned **Off**, there is no space. *Default = On.*



UPEADS1.
* On



UPEADS0.
Off

UPC-E0 Check Digit

Check Digit specifies whether the check digit should be transmitted at the end of the scanned data or not. *Default = On.*



UPECKX1.
* On



UPECKX0.
Off

UPC-E0 Leading Zero

This feature allows the transmission of a leading zero (0) at the beginning of scanned data. To prevent transmission, scan **Off**. *Default = On.*



UPENSX1.

* On



UPENSX0.

Off

UPC-E0 Addenda

This selection adds 2 or 5 digits to the end of all scanned UPC-E data. *Default = Off for both 2 Digit and 5 Digit Addenda.*



UPEAD21.

2 Digit Addenda On



UPEAD20.

* 2 Digit Addenda Off



UPEAD51.

5 Digit Addenda On



UPEAD50.

* 5 Digit Addenda Off

UPC-E1

Most U.P.C. barcodes lead with the 0 number system. For these codes, use [UPC-E0](#) (page 123). If you need to read codes that lead with the 1 number system, use the **UPC-E1 On** selection. *Default = Off.*



UPEEN11.

UPC-E1 On



EAN/JAN-13

<Default All EAN/JAN Settings>



EAN/JAN-13 On/Off



Convert UPC-A to EAN-13

When **UPC-A Converted to EAN-13** is selected, UPC-A barcodes are converted to 13 digit EAN-13 codes by adding a zero to the front. When **Do not Convert UPC-A** is selected, UPC-A codes are read as UPC-A.



EAN/JAN-13 Check Digit

This selection allows you to specify whether the check digit should be transmitted at the end of the scanned data or not. *Default = On.*



E13CKX1.

* On



E13CKX0.

Off

EAN/JAN-13 Addenda

This selection adds 2 or 5 digits to the end of all scanned EAN/JAN-13 data. *Default = Off for both 2 Digit and 5 Digit Addenda.*



E13AD21.

2 Digit Addenda On



E13AD20.

* 2 Digit Addenda Off



E13AD51.

5 Digit Addenda On



E13AD50.

* 5 Digit Addenda Off

EAN/JAN-13 Addenda Required

When **Required** is scanned, the scanner will only read EAN/JAN-13 barcodes that have addenda. *Default = Not Required.*



E13ARQ1.

Required



E13ARQ0.

* Not Required

EAN-13 Beginning with 290 Addenda Required

This setting programs the scanner to require a 5 digit addenda only on EAN-13 barcodes that begin with “290.” The following settings can be programmed:

Require 5 Digit Addenda: All EAN-13 barcodes that begin with “290” must have a 5 digit addendum. The EAN-13 barcode with the 5 digit addendum is then transmitted as a single, concatenated barcode. If a 5 digit addendum is not found within the [Addenda Timeout](#) period, the EAN-13 barcode is discarded.

Note: *If you are using [EAN-13 Beginning with 290 Addenda Required](#) (page 128), this setting will take precedence.*

Don’t Require 5 Digit Addenda: If you have selected Require 5 Digit Addenda, and you want to disable this feature, scan **Don’t Require 5 Digit Addenda**. EAN-13 barcodes are transmitted, depending on the setting you are using for [EAN/JAN-13 Addenda Required](#).

Default = Don’t Require 5 Digit Addenda.



ARQ2900.

* Don’t Require 5 Digit Addenda



ARQ2901.

Require 5 Digit Addenda

EAN-13 Beginning with 378/379 Addenda Required

This setting programs the scanner to require any combination of a 2 digit addenda or a 5 digit addenda on EAN-13 barcodes that begin with a “378” or “379.” The following settings can be programmed:

Require Addenda: All EAN-13 barcodes that begin with a “378” or “379” must have a 2 digit addenda, a 5 digit addenda, or a combination of these addenda. The EAN-13 barcode with the addenda is then transmitted as a single, concatenated barcode. If the required addenda is not found within the [Addenda Timeout](#) period, the EAN-13 barcode is discarded.

Don’t Require Addenda: If you have selected Require Addenda, and you want to disable this feature, scan **Don’t Require Addenda**. EAN-13 barcodes are transmitted, depending on the setting you are using for [EAN/JAN-13 Addenda Required](#).

Default = Don't Require Addenda.



ARQ3780.

* Don't Require Addenda



ARQ3781.

Require 2 Digit Addenda



ARQ3782.

Require 5 Digit Addenda



ARQ3783.

Require 2 or 5 Digit Addenda

EAN-13 Beginning with 414/419 Addenda Required

This setting programs the scanner to require any combination of a 2 digit addenda or a 5 digit addenda on EAN-13 barcodes that begin with a "414" or "419." The following settings can be programmed:

Require Addenda: All EAN-13 barcodes that begin with a "414" or "419" must have a 2 digit addenda, a 5 digit addenda, or a combination of these addenda. The EAN-13 barcode with the addenda is then transmitted as a single, concatenated barcode. If the required addenda is not found within the [Addenda Timeout](#) period, the EAN-13 barcode is discarded.

Don't Require Addenda: If you have selected Require Addenda, and you want to disable this feature, scan **Don't Require Addenda**. EAN-13 barcodes are transmitted, depending on the setting you are using for [EAN/JAN-13 Addenda Required](#).

Default = Don't Require Addenda.



ARQ4140.

* Don't Require Addenda



ARQ4141.

Require 2 Digit Addenda



ARQ4142.

Require 5 Digit Addenda



ARQ4143.

Require 2 or 5 Digit Addenda

EAN-13 Beginning with 434/439 Addenda Required

This setting programs the scanner to require any combination of a 2 digit addenda or a 5 digit addenda on EAN-13 barcodes that begin with a “434” or “439.” The following settings can be programmed:

Require Addenda: All EAN-13 barcodes that begin with a “434” or “439” must have a 2 digit addenda, a 5 digit addenda, or a combination of these addenda. The EAN-13 barcode with the addenda is then transmitted as a single, concatenated barcode. If the required addenda is not found within the [Addenda Timeout](#) period, the EAN-13 barcode is discarded.

Don't Require Addenda: If you have selected Require Addenda, and you want to disable this feature, scan **Don't Require Addenda**. EAN-13 barcodes are transmitted, depending on the setting you are using for [EAN/JAN-13 Addenda Required](#).

Default = Don't Require Addenda.



ARQ4340.

* Don't Require Addenda



ARQ4341.

Require 2 Digit Addenda



ARQ4342.

Require 5 Digit Addenda



ARQ4343.

Require 2 or 5 Digit Addenda

EAN-13 Beginning with 977 Addenda Required

This setting programs the scanner to require a 2 digit addenda only on EAN-13 barcodes that begin with “977.” The following settings can be programmed:

Require 2 Digit Addenda: All EAN-13 barcodes that begin with “977” must have a 2 digit addendum. The EAN-13 barcode with the 2 digit addendum is then transmitted as a single, concatenated barcode. If a 2 digit addendum is not found within the [Addenda Timeout](#) period, the EAN-13 barcode is discarded.

Don't Require 2 Digit Addenda: If you have selected Require 2 Digit Addenda, and you want to disable this feature, scan **Don't Require 2 Digit Addenda**. EAN-13 barcodes are transmitted, depending on the setting you are using for [EAN/JAN-13 Addenda Required](#).

Default = Don't Require 2 Digit Addenda.



* Don't Require 2 Digit Addenda



Require 2 Digit Addenda

EAN-13 Beginning with 978 Addenda Required

These settings program the scanner to require a 5 digit addenda only on EAN-13 barcodes that begin with “978.” The following settings can be programmed:

Require 5 Digit Addenda: All EAN-13 barcodes that begin with “978” must have a 5 digit addendum. The EAN-13 barcode with the 5 digit addendum is then transmitted as a single, concatenated barcode. If a 5 digit addendum is not found within the [Addenda Timeout](#) period, the EAN-13 barcode is discarded.

Don't Require 5 Digit Addenda: If you have selected Require 5 Digit Addenda, and you want to disable this feature, scan **Don't Require 5 Digit Addenda**. EAN-13 barcodes are transmitted, depending on the setting you are using for [EAN/JAN-13 Addenda Required](#).

Default = Don't Require 5 Digit Addenda.



* Don't Require 5 Digit Addenda



Require 5 Digit Addenda

EAN-13 Beginning with 979 Addenda Required

These settings program the scanner to require a 5 digit addenda only on EAN-13 barcodes that begin with “979.” The following settings can be programmed:

Require 5 Digit Addenda: All EAN-13 barcodes that begin with “979” must have a 5 digit addendum. The EAN-13 barcode with the 5 digit addendum is then transmitted as a single, concatenated barcode. If a 5 digit addendum is not found within the [Addenda Timeout](#) period, the EAN-13 barcode is discarded.

Don't Require 5 Digit Addenda: If you have selected Require 5 Digit Addenda, and you want to disable this feature, scan **Don't Require 5 Digit Addenda**. EAN-13 barcodes are transmitted, depending on the setting you are using for [EAN/JAN-13 Addenda Required](#).

Default = Don't Require 5 Digit Addenda.



* Don't Require 5 Digit Addenda



Addenda Timeout

You can set a time during which the scanner looks for an addenda. If an addenda is not found within this time period, the data can be either transmitted or discarded, based on the setting you are using for [EAN/JAN-13 Addenda Required](#). Set the length (in milliseconds) for this timeout by scanning the barcode below, then setting the timeout (from 0-500 milliseconds) by scanning digits from the [Programming Chart](#), beginning on page 241 of this manual, then **Save**. *Default = 120.*

Note: *The Addenda Timeout setting is applied to all addenda and coupon code searches.*



EAN/JAN-13 Addenda Separator

When this feature is On, there is a space between the data from the barcode and the data from the addenda. When turned Off, there is no space. *Default = On.*



Note: *If you want to enable or disable EAN13 with Extended Coupon Code, refer to [UPC-A/ EAN-13 with Extended Coupon Code](#) (page 121).*

ISBN Translate

When **On** is scanned, EAN-13 Bookland symbols are translated into their equivalent ISBN number format. *Default = Off.*



E13ISB1.

On



E13ISB0.

*** Off**

EAN/JAN-8

<Default All EAN/JAN-8 Settings>



EA8DFT.

EAN/JAN-8 On/Off



EA8ENA1.

*** On**



EA8ENA0.

Off

EAN/JAN-8 Check Digit

This selection allows you to specify whether or not the check digit should be transmitted at the end of the scanned data. *Default = On.*



EA8CKX1.

*** On**



EA8CKX0.

Off

EAN/JAN-8 Addenda

This selection adds 2 or 5 digits to the end of all scanned EAN/JAN-8 data.
Default = Off for both 2 Digit and 5 Digit Addenda.



EA8AD21.
2 Digit Addenda On



EA8AD20.
* 2 Digit Addenda Off



EA8AD51.
5 Digit Addenda On



EA8AD50.
* 5 Digit Addenda Off

EAN/JAN-8 Addenda Required

When **Required** is scanned, the scanner will only read EAN/JAN-8 barcodes that have addenda. *Default = Not Required.*



EA8ARQ1.
Required



EA8ARQ0.
* Not Required

Addenda Timeout

You can set a time during which the scanner looks for an addenda. If an addenda is not found within this time period, the data can be either transmitted or discarded, based on the setting you are using for [EAN/JAN-8 Addenda Required](#). Set the length (in milliseconds) for this timeout by scanning the barcode below, then

setting the timeout (from 0-500 milliseconds) by scanning digits from the [Programming Chart](#), beginning on page 241 of this manual, then **Save**. *Default = 120.*

Note: *The Addenda Timeout setting is applied to all addenda and coupon code searches.*



EAN/JAN-8 Addenda Separator

When this feature is **On**, there is a space between the data from the barcode and the data from the addenda. When turned **Off**, there is no space. *Default = On.*



MSI

<Default All MSI Settings>



MSI On/Off



MSI Check Character

Different types of check characters are used with MSI barcodes. You can program the scanner to read MSI barcodes with Type 10 check characters. *Default = Validate Type 10, but Don't Transmit.*

When Check Character is set to **Validate Type 10/11 and Transmit**, the scanner will only read MSI barcodes printed with the specified type check character(s), and will transmit the character(s) at the end of the scanned data.

When Check Character is set to **Validate Type 10/11, but Don't Transmit**, the unit will only read MSI barcodes printed with the specified type check character(s), but will not transmit the check character(s) with the scanned data.



MSICK0.

* Validate Type 10, but Don't Transmit



MSICK1.

Validate Type 10 and Transmit



MSICK2.

Validate 2 Type 10 Characters, but Don't Transmit



MSICK3.

Validate 2 Type 10 Characters and Transmit



MSICK4.

Validate Type 11 then Type 10 Character, but Don't Transmit



MSICK5.

Validate Type 11 then Type 10 Character and Transmit



MSICK6.

Disable MSI Check Characters

MSI Message Length

Scan the barcodes below to change the message length. Refer to [Message Length Description](#) (page 100) for additional information. Minimum and Maximum lengths = 4-48. Minimum Default = 4, Maximum Default = 48.



MSIMIN.

Minimum Message Length



MSIMAX.

Maximum Message Length

GS1 DataBar Omnidirectional

< Default All GS1 DataBar Omnidirectional Settings >



RSSDFT.

GS1 DataBar Omnidirectional On/Off



RSENA1.

* On



RSENA0.

Off

GS1 DataBar Limited

< Default All GS1 DataBar Limited Settings >



GS1 DataBar Limited On/Off



GS1 DataBar Expanded

< Default All GS1 DataBar Expanded Settings >



GS1 DataBar Expanded On/Off



GS1 DataBar Expanded Message Length

Scan the barcodes below to change the message length. Refer to [Message Length Description](#) (page 100) for additional information. Minimum and Maximum lengths = 4-74. Minimum Default = 4, Maximum Default = 74.





Trioptic Code

Note: If you are going to scan Code 32 Pharmaceutical codes ([page 105](#)), Trioptic Code must be off.

Trioptic Code is used for labeling magnetic storage media.



Codablock A

<Default All Codablock A Settings>



Codablock A On/Off

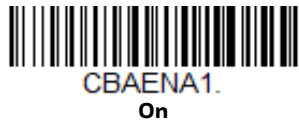

If you are reading Code 39 barcodes, Codablock A should remain disabled. If you are enabling Codablock A, you should disable Code 39 (see [Code 39](#) on page 103).

Codablock A Message Length

Scan the barcodes below to change the message length. Refer to [Message Length Description](#) (page 100) for additional information. Minimum and Maximum lengths = 1-600. Minimum Default = 1, Maximum Default = 600.



CBAMIN.

Minimum Message Length



CBAMAX.

Maximum Message Length

Codablock F

<Default All Codablock F Settings>



CBFDF.

Codablock F On/Off



CBFENA1.

On



CBFENA0.

*** Off**

If you are reading Code 128 barcodes, Codablock F should remain disabled. If you are enabling Codablock F, you should disable Code 128 (see [Code 128](#) on page 115).

Codablock F Message Length

Scan the barcodes below to change the message length. Refer to [Message Length Description](#) (page 100) for additional information. Minimum and Maximum lengths = 1-2048. Minimum Default = 1, Maximum Default = 2048.



CBFMIN.

Minimum Message Length



Label Code

The standard Label Code is used in libraries. *Default = Off.*



PDF417

< *Default All PDF417 Settings* >



PDF417 On/Off



PDF417 Message Length

Scan the barcodes below to change the message length. Refer to [Message Length Description](#) (page 100) for additional information. Minimum and Maximum lengths = 1-2750. Minimum Default = 1, Maximum Default = 2750.



MacroPDF417

MacroPDF417 is an implementation of PDF417 capable of encoding very large amounts of data into multiple PDF417 barcodes. When this selection is enabled, these multiple barcodes are assembled into a single data string. *Default = On.*



MicroPDF417

< Default All MicroPDF417 Settings >



MicroPDF417 On/Off





MicroPDF417 Message Length

Scan the barcodes below to change the message length. Refer to [Message Length Description](#) (page 100) for additional information. Minimum and Maximum lengths = 1-366. Minimum Default = 1, Maximum Default = 366.



GS1 Composite Codes

Linear codes are combined with a unique 2D composite component to form a new class called GS1 Composite symbology. GS1 Composite symbologies allow for the co-existence of symbologies already in use. *Default = Off.*



UPC/EAN Version

Scan the **UPC/EAN Version On** barcode to decode GS1 Composite symbols that have a U.P.C. or an EAN linear component. (This does not affect GS1 Composite symbols with a GS1-128 or GS1 linear component.) *Default = UPC/EAN Version Off.*



Note: *If you scan coupons that have both UPC and GS1 Databar codes, you may wish to scan and output only the data from the GS1 Databar code. See [Coupon GS1 DataBar Output](#) (page 122) for further information.*

GS1 Composite Code Message Length

Scan the barcodes below to change the message length. Refer to [Message Length Description](#) (page 100) for additional information. Minimum and Maximum lengths = 1-2435. Minimum Default = 1, Maximum Default = 2435.



GS1 Emulation

The scanner can automatically format the output from any GS1 data carrier to emulate what would be encoded in an equivalent GS1-128 or GS1 DataBar symbol. GS1 data carriers include UPC-A and UPC-E, EAN-13 and EAN-8, ITF-14, GS1-128, and GS1 DataBar and GS1 Composites. (Any application that accepts GS1 data can be simplified since it only needs to recognize one data carrier type.)

If **GS1-128 Emulation** is scanned, all retail codes (U.P.C., UPC-E, EAN8, EAN13) are expanded out to 16 digits. If the **AIM ID** is enabled, the value will be the GS1-128 AIM ID,]C1 (see [Symbology Charts](#) on page 227).

If **GS1 DataBar Emulation** is scanned, all retail codes (U.P.C., UPC-E, EAN8, EAN13) are expanded out to 16 digits. If the AIM ID is enabled, the value will be the GS1-DataBar AIM ID,]em (see [Symbology Charts](#) on page 227).

If **GS1 Code Expansion Off** is scanned, retail code expansion is disabled, and UPC-E expansion is controlled by the [UPC-E0 Expand](#) (page 123) setting. If the AIM ID is enabled, the value will be the GS1-128 AIM ID,]C1 (see [Symbology Charts](#) on page 227).

If **EAN8 to EAN13 Conversion** is scanned, all EAN8 barcodes are converted to EAN13 format.

Default = GS1 Emulation Off.



EANEMU1.
GS1-128 Emulation



EANEMU2.
GS1 DataBar Emulation



EANEMU3.
GS1 Code Expansion Off



EANEMU4.
EAN8 to EAN13 Conversion



EANEMU0.
* GS1 Emulation Off

TCIF Linked Code 39 (TLC39)

This code is a composite code since it has a Code 39 linear component and a MicroPDF417 stacked code component. All barcode readers are capable of reading the Code 39 linear component. The MicroPDF417 component can only be decoded if TLC39 **On** is selected. The linear component may be decoded as Code 39 even if TLC39 is off. *Default = Off.*



T39ENA1.
On



T39ENA0.
* Off

QR Code

< Default All QR Code Settings >



QR Code On/Off

This selection applies to both QR Code and Micro QR Code.



QR Code Message Length

Scan the barcodes below to change the message length. Refer to [Message Length Description](#) (page 100) for additional information. Minimum and Maximum lengths = 1-7089. Minimum Default = 1, Maximum Default = 7089.



QR Code Append

This function allows the scanner to append the data from several QR Code barcodes together before transmitting them to the host computer. When the scanner encounters an QR Code barcode with the append trigger character(s), it buffers the number of QR Code barcodes determined by information encoded in those barcodes. Once the proper number of codes is reached, the data is output in the order specified in the barcodes. There are 3 ways to scan appended QR Code:

One Scan: Pull the trigger one time and all appended QR Codes in the same image are decoded.

Swipe: Pull and hold down the trigger and scan all appended QR Codes while keeping the trigger pressed. The scanner emits short beeps for each partial QR Code that is scanned and buffered. One long beep is emitted after the last QR Code is scanned and the data is complete. Not compatible with Presentation mode.

Point and Shoot: Pull the trigger one time for each image. The scanner emits a short beep for each partial QR Code that is scanned and buffered. One long beep is emitted after the last QR Code is scanned and the data is complete. Not compatible with Presentation mode.

Default = One Scan.



QRCAPP1.
* One Scan



QRCAPP2.
Swipe



QRCAPP3.
Point and Shoot



QRCAPP0.
Off

QR Code Page

QR Code pages define the mapping of character codes to characters. If the data received does not display with the proper characters, it may be because the barcode being scanned was created using a code page that is different from the one the host program is expecting. If this is the case, scan the barcode below, select the code page with which the barcodes were created (see [ISO 2022/ISO 646 Character Replacements](#) on page 234), and scan the value and the **Save** barcode from the [Programming Chart](#), beginning on page 241. The data characters should then appear properly.



QRCDP.
QR Code Page

Prohibit QR Code with Web Link

Use this function to disable or enable the scanning of QR codes that contain “http” or “https”.



QRCWEB1.
*On
(Prohibit QR codes with
web links)



QRCWEB0.
Off
(Allow QR codes with web links)

DotCode

< Default All DotCode Settings >



DOTDFT.

DotCode On/Off



DOTENA1.
On



DOTENA0.
* Off

Poor Quality DotCodes

This setting improves the scanner’s ability to read damaged or badly printed DotCodes. *Default = Poor Quality DotCodes Off.*



DOTXS1.
Poor Quality DotCodes On



DOTEXS0.

* Poor Quality DotCodes Off

DotCode Message Length

Scan the barcodes below to change the message length. Refer to [Message Length Description](#) (page 100) for additional information. Minimum and Maximum lengths = 1-2400. Minimum Default = 1, Maximum Default = 2400.



DOTMIN.

Minimum Message Length



DOTMAX.

Maximum Message Length

Digimarc Barcode™

Digimarc Decoder Attempts

Set the number of attempts by scanning the barcode below, then setting the number of attempts (0-10) by scanning digits from the [Programming Chart](#) beginning on page 241 of this manual, the **Save**. *Minimum to Maximum attempts = 0-10. Default = 3.*



DIGSTR.

Digimarc Decoder Attempts

Digimarc Barcode

This setting programs the scanner to decode Digimarc Barcode using Digimarc and ID decoders. When Digimarc Barcode is set to **On**, the Digimarc decoder is used on most frames and the ID decoder will read every fifth frame.

When Digimarc Barcode is set to **Uses ID Decoder then Both Decoders**, the ID decoder will read the number of attempts set by the Digimarc Decoder Attempts and then will use both ID and Digimarc decoders. When Digimarc Barcode is set to **Uses Digimarc Decoder then Both Decoders**, the Digimarc decoder will read the number of attempts set by the Digimarc Decoder Attempts and then will use both ID and Digimarc decoders.

When Digimarc Barcode is set to **Uses ID Decoder then Alternates Decoders**, the ID decoder will read the number of attempts set by the Digimarc Decoder Attempts and then will alternate between ID and Digimarc decoders. When Digimarc Barcode is set to **Uses Digimarc Decoder then Alternates Decoders**, the Digimarc decoder will read the number of attempts set by the Digimarc Decoder Attempts and then will alternate between ID and Digimarc decoders.

Default = Uses Digimarc Decoder then Both Decoders.



DIGENA0.

Off



DIGENA1.

On



DIGENA2.

Uses ID Decoder then Both Decoders



DIGENA3.

*** Uses Digimarc Decoder then Both Decoders**



DIGENA4.

Uses ID Decoder then Alternates Decoders



DIGENA5.

Uses Digimarc Decoder then Alternates Decoders

Data Matrix

< Default All Data Matrix Settings >



Data Matrix On/Off



Direct Part Marking Decoding

If you are having trouble reading Direct Part Marking (DPM) barcodes, scan **Dotpeen DPM Decoding** for Dotpeen codes or scan **Reflective (Etched) DPM Decoding** for reflective (etched) codes. *Default = Disable DPM Decoding.*



Data Matrix Message Length

Scan the barcodes below to change the message length. Refer to [Message Length Description](#) (page 100) for additional information. Minimum and Maximum lengths = 1-3116. Minimum Default = 1, Maximum Default = 3116.



Data Matrix Code Page

Data Matrix Code pages define the mapping of character codes to characters. If the data received does not display with the proper characters, it may be because the barcode being scanned was created using a code page that is different from the one the host program is expecting. If this is the case, scan the barcode below, select the code page with which the barcodes were created (see [ISO 2022/ISO 646 Character Replacements](#) on page 234), and scan the value and the **Save** barcode from the [Programming Chart](#), beginning on page 241. The data characters should then appear properly.



MaxiCode

< Default All MaxiCode Settings >



MaxiCode On/Off



MaxiCode Message Length

Scan the barcodes below to change the message length. Refer to [Message Length Description](#) (page 100) for additional information. Minimum and Maximum lengths = 1-150. Minimum Default = 1, Maximum Default = 150.



Aztec Code

< [Default All Aztec Code Settings](#) >



Aztec Code On/Off



Aztec Code Message Length

Scan the barcodes below to change the message length. Refer to [Message Length Description](#) (page 100) for additional information. Minimum and Maximum lengths = 1-3832. Minimum Default = 1, Maximum Default = 3832.



Aztec Append

This function allows the scanner to append the data from several Aztec barcodes together before transmitting them to the host computer. When the scanner encounters an Aztec barcode with the append trigger character(s), it buffers the number of Aztec barcodes determined by information encoded in those barcodes. Once the proper number of codes is reached, the data is output in the order specified in the barcodes. *Default = On.*



Aztec Code Page

Aztec Code pages define the mapping of character codes to characters. If the data received does not display with the proper characters, it may be because the barcode being scanned was created using a code page that is different from the one the host program is expecting. If this is the case, scan the barcode below, select the code page with which the barcodes were created (see [ISO 2022/ISO 646 Character Replacements](#) on page 234), and scan the value and the **Save** barcode from the [Programming Chart](#), beginning on page 241. The data characters should then appear properly.



Chinese Sensible (Han Xin) Code

< Default All Han Xin Settings >



Han Xin Code On/Off

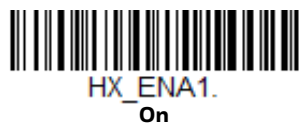



HX_ENA0.

* Off

Han Xin Code Message Length

Scan the barcodes below to change the message length. Refer to [Message Length Description](#) (page 100) for additional information. Minimum and Maximum lengths = 1-7833. Minimum Default = 1, Maximum Default = 7833.



HX_MIN.

Minimum Message Length



HX_MAX.

Maximum Message Length

Postal Codes - 2D

The following lists the possible 2D postal codes, and 2D postal code combinations that are allowed. Only one 2D postal code selection can be active at a time. If you scan a second 2D postal code selection, the first selection is overwritten. *Default = 2D Postal Codes Off.*



POSTAL0.

* 2D Postal Codes Off

Single 2D Postal Codes:



POSTAL1.

Australian Post On



POSTAL7.

British Post On



POSTAL30.

Canadian Post On



POSTAL3.
Japanese Post On



POSTAL5.
Planet Code On

Also see [Planet Code Check Digit](#), page 159.



POSTAL6.
Postnet On

Also see [Postnet Check Digit](#), page 159.



POSTAL2.
InfoMail On



POSTAL10.
Intelligent Mail Barcode On



POSTAL4.
KIX Post On



POSTAL9.
Postal-4i On



POSTAL11.
Postnet with B and B' Fields On

Combination 2D Postal Codes:



POSTAL8.
InfoMail and British
Post On



POSTAL14.
Postnet and
Postal-4i On



POSTAL17.
Postal-4i and
Intelligent Mail Barcode On



POSTAL12.
Planet Code and
Postnet On



POSTAL13.
Planet Code and
Postal-4i On



POSTAL21.
Planet Code,
Postnet, and
Postal-4i On



POSTAL20.
Intelligent Mail Barcode and
Postnet with B and B' Fields On



POSTAL16.
Postnet and
Intelligent Mail Barcode On



POSTAL19.
Postal-4i and
Postnet with B and B' Fields On



POSTAL18.
Planet Code and
Postnet with B and B' Fields On



POSTAL15.
Planet Code and
Intelligent Mail Barcode



POSTAL23.
Planet Code,
Postal-4i, and
Intelligent Mail Barcode On



POSTAL25.
Planet Code,
Postal-4i, and
Postnet with B and B' Fields On



POSTAL27.
Postal-4i,
Intelligent Mail Barcode, and
Postnet with B and B' Fields On



POSTAL29.
Planet Code,
Postal-4i,
Intelligent Mail Barcode, and
Postnet with B and B' Fields On



POSTAL22.
Planet Code,
Postnet, and
Intelligent Mail Barcode On



POSTAL24.
Postnet,
Postal-4i, and
Intelligent Mail Barcode On



POSTAL26.
Planet Code,
Intelligent Mail Barcode, and
Postnet with B and B' Fields On



POSTAL28.
Planet Code,
Postal-4i,
Intelligent Mail Barcode, and
Postnet On

Planet Code Check Digit

This selection allows you to specify whether the check digit should be transmitted at the end of Planet Code data. *Default = Don't Transmit.*



PLNCKX1.

Transmit Check Digit



PLNCKX0.

* Don't Transmit Check Digit

Postnet Check Digit

This selection allows you to specify whether the check digit should be transmitted at the end of Postnet data. *Default = Don't Transmit.*



NETCKX1.

Transmit Check Digit



NETCKX0.

* Don't Transmit Check Digit

Australian Post Interpretation

This option controls what interpretation is applied to customer fields in Australian 4-State symbols.

Bar Output lists the bar patterns in “0123” format.

Numeric N Table causes that field to be interpreted as numeric data using the N Table.

Alphanumeric C Table causes the field to be interpreted as alphanumeric data using the C Table. Refer to the Australian Post Specification Tables.

Combination C and N Tables causes the field to be interpreted using either the C or N Tables.



AUSINT0.

* Bar Output



AUSINT1.
Numeric N Table



AUSINT2.
Alphanumeric C Table



AUSINT3.
Combination C and N Tables

Postal Codes - Linear

The following lists linear postal codes. Any combination of linear postal code selections can be active at a time.

China Post (Hong Kong 2 of 5)

<Default All China Post (Hong Kong 2 of 5) Settings>



CPCDFT.

China Post (Hong Kong 2 of 5) On/Off



CPCENA1.
On



CPCENA0.
* Off

China Post (Hong Kong 2 of 5) Message Length

Scan the barcodes below to change the message length. Refer to [Message Length Description](#) (page 100) for additional information. Minimum and Maximum lengths = 2-80. Minimum Default = 4, Maximum Default = 80.



CPCMIN.
Minimum Message Length



Korea Post

<Default All Korea Post Settings>



Korea Post



Korea Post Message Length

Scan the barcodes below to change the message length. Refer to [Message Length Description](#) (page 100) for additional information. Minimum and Maximum lengths = 2-80. Minimum Default = 4, Maximum Default = 48.



Korea Post Check Digit

This selection allows you to specify whether the check digit should be transmitted or not. *Default = Don't Transmit.*





KPCCHK0.

* Don't Transmit Check Digit

The scanner is like a digital camera in the way it captures, manipulates, and transfers images. The following commands allow you to alter the way the scanner performs these functions.

Single-Use Basis

Imaging Commands with their modifiers send instructions to the scanner on a single-use basis, and take effect for a single image capture. Once that capture is complete, the scanner reverts to its imaging default settings. If you want to permanently change a setting, you must use the serial default commands (see [Chapter 9](#)). When the serial default command is used, that selection becomes the new, permanent setting for the scanner.

Command Syntax

Multiple modifiers and commands can be issued within one sequence. If additional modifiers are to be applied to the same command, just add the modifiers to that command. For example, to add 2 modifiers to the Image Snap command, such as setting the Imaging Style to 1P and the Wait for Trigger to 1T, you would enter **IMG SNP1P1T**.

Note: After processing an image capture command (*IMG SNP* or *IMG BOX*), you must follow it with an *IMG SHP* command if you want to see it on your terminal.

To add a command to a sequence, each new command is separated with a semicolon. For example, to add the Image Ship command to the above sequence, you would enter *IMG SNP1P1T;IMG SHP*.

The imaging commands are:

[Image Snap - IMG SNP](#) (page 164)

[Image Ship - IMG SHP](#) (page 167)

[Intelligent Signature Capture - IMG BOX](#) (page 176)

The modifiers for each of these commands follow the command description.

Note: *The images included with each command description are examples only. The results you achieve may be different from those included in this manual. The quality of the output you receive will vary depending on lighting, quality of the initial image/object being captured, and distance of the scanner from the image/object. To achieve a high quality image, it is recommended that you position your scanner 4-6" (10.2-15.2 cm) away from the image/object you are capturing.*

Step 1 - Take a Picture Using IMGSNP

Image Snap - IMGSNP

An image is taken whenever the hardware trigger is pressed, or when the Image Snap (IMGSNP) command is processed.

The image snap command has many different modifiers that can be used to change the look of the image in memory. Any number of modifiers may be appended to the IMGSNP command.

Example: You can use the following command to snap an image, increase the gain, and have the beeper sound once the snap is complete: **IMGSNP2G1B**

IMGSNP Modifiers

P - Imaging Style

This sets the Image Snap style.

- 0P **Decoding Style.** This processing allows a few frames to be taken until the exposure parameters are met. The last frame is then available for further use.
- 1P **Photo Style (default).** This mimics a simple digital camera, and results in a visually optimized image.
- 2P **Manual Style.** This is an advanced style that should only be used by an experienced user. It allows you the most freedom to set up the scanner, and has no auto-exposure.

B - Beeper

Causes a beep to sound after an image is snapped.

- 0B No beep (default)
- 1B Sounds a beep when the image is captured

T - Wait for Trigger

Waits for a hardware trigger press before taking the image. This is only available when using Photo Style (1P).

- 0T Takes image immediately (*default*)
- 1T Waits for a trigger press, then takes the image

L - LED State

Determines if the LEDs should be on or off, and when. Ambient illumination (0L) is preferred for taking pictures of color documents, such as ID cards, especially when the scanner is in a stand. LED illumination (1L) is preferred when the scanner is handheld. LED State is not available when using Decoding Style (0P).

- 0L LEDs off (*default*)
- 1L LEDs on

E - Exposure

Exposure is used in Manual Style only (2P), and allows you to set the exposure time. This is similar to setting a shutter speed on a camera. The exposure time determines how long the scanner takes to record an image. On a bright day, exposure times can be very short because plenty of light is available to help record an image. At nighttime, exposure time can increase dramatically due to the near absence of light. Units are 127 microseconds. (*Default = 7874*)

- nE Range: 1 - 7874

Example:

Exposure at 7874E with fluorescent lighting:

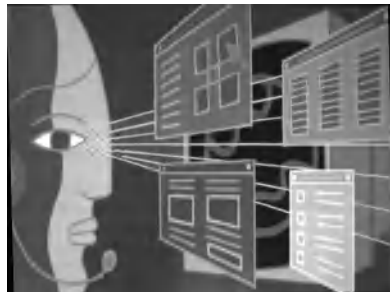

Exposure at 100E with fluorescent lighting:



G - Gain

Gain is used in Manual Style only (2P). Like a volume control, the gain modifier boosts the signal and multiplies the pixel value. As you increase the gain, the noise in an image is also amplified.

1G No gain (*default*)

2G Medium gain

4G Heavy gain

8G Maximum gain

Example:

Gain at 1G:



Gain at 4G:



Gain at 8G:



W - Target White Value

Sets the target for the median grayscale value in the captured image. For capturing close-up images of high contrast documents, a lower setting, such as 75, is recommended. Higher settings result in longer exposure times and brighter images, but if the setting is too high, the image may be overexposed. Target White Value is only available when using Photo Style (1P). (*Default = 125*)

nW Range: 0 - 255

Example:

White Value at 75W:



White Value at 125W:



White Value at 200W:



D - Delta for Acceptance

This sets the allowable range for the white value setting ([see W - Target White Value](#)). Delta is only available when using Photo Style (1P). (*Default = 25*)

nD Range: 0 - 255

U - Update Tries

This sets the maximum number of frames the scanner should take to reach the [D - Delta for Acceptance](#). Update Tries is only available when using Photo Style (1P). (Default = 6)

nU Range: 0 - 10

% - Target Set Point Percentage

Sets the target point for the light and dark values in the captured image. A setting of 75% means 75% of the pixels are at or below the target white value, and 25% of the pixels are above the target white value. Altering this setting from the default is not recommended under normal circumstances. To alter grayscale values, [W - Target White Value](#) should be used. (Default = 50)

n% Range: 1 - 99

Example:

Target Set Point Percentage at 97%:

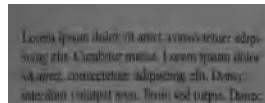

Target Set Point Percentage at 50%:

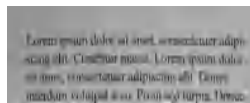

Target Set Point Percentage at 40%:

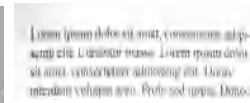

Step 2 - Ship a Picture Using IMGSHIP

Image Ship - IMGSHIP

An image is taken whenever the trigger is pressed or when the Image Snap (IMGSNP) command is processed. The last image is always stored in memory. You can “ship” the image by using the IMGSHIP command.

The image ship commands have many different modifiers that can be used to change the look of the image output. Modifiers affect the image that is transmitted, but do not affect the image in memory. Any number of modifiers may be appended to the IMGSHIP command.

Example: You can use the following command to snap and ship a bitmap image with gamma correction and document image filtering: `IMGSNP;IMGSHIP8F75K26U`.

IMGSHHP Modifiers

A - Infinity Filter

Enhances pictures taken from very long distances (greater than 10 feet or 3m). The Infinity Filter should not be used with [IMGSNP Modifiers](#) (page 164).

0A Infinity filter off (*default*)

1A Infinity filter on

Example:

Infinity Filter off (0A)
from approximately 12 feet
(3.66m) away:

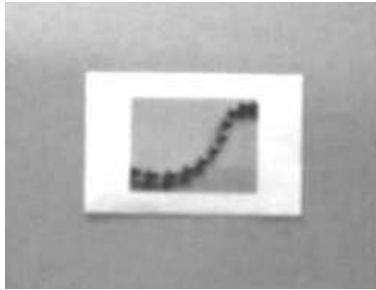

Infinity Filter on (1A)
from approximately 12 feet (3.66m)
away:

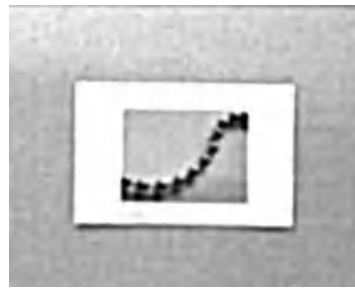

C - Compensation

Flattens the image to account for variations in illumination across the image.

0C Compensation disabled (*default*)

1C Compensation enabled

Example:

Compensation at 0C:



Compensation at 1C:



D - Pixel Depth

Indicates the number of bits per pixel in the transmitted image (KIM or BMP format only).

8D 8 bits per pixel, grayscale image (*default*)

1D 1 bit per pixel, black and white image

E - Edge Sharpen

An edge sharpen filter cleans up the edges of an image, making it look cleaner and sharper. While edge sharpening does make the image look cleaner, it also removes some fine detail from the original image. The strength of the edge sharpen filter can be entered from 1 to 24. Entering a **23E** gives the sharpest edges, but also increases noise in the image.

- 0E Don't sharpen image (*default*)
- 14E Apply edge sharpen for typical image
- ne* Apply edge sharpen using strength *n* ($n = 1-24$)

Example:

Edge Sharpen at 0E:



Edge Sharpen at 24E:



F - File Format

Indicates the desired format for the image.

- 0F KIM format
- 1F TIFF binary
- 2F TIFF binary group 4, compressed
- 3F TIFF grayscale
- 4F Uncompressed binary (upper left to lower right, 1 pixel/bit, 0 padded end of line)
- 5F Uncompressed grayscale (upper left to lower right, bitmap format)
- 6F JPEG image (*default*)
- 8F BMP format (lower right to upper left, uncompressed)
- 15F BMP Uncompressed raw image

H - Histogram Stretch

Increases the contrast of the transmitted image. Not available with some image formats.

0H No stretch (*default*)

1H Histogram stretch

Example:

Histogram Stretch at 0H:



Histogram Stretch at 1H:



I - Invert Image

Invert image is used to rotate the image around the X or Y axis.

1ix Invert around the X axis (flips picture upside down)

1iy Invert around the Y axis (flips picture left to right)

Example:

Image not inverted:



Image with Invert Image set to 1ix:



Image with Invert Image set to 1iy:



IF- Noise Reduction

Used to reduce the salt and pepper noise in an image.

0if No salt and pepper noise reduction (default)

1if Salt and pepper noise reduction

Example:

Noise Reduction Off (0if):



Noise Reduction On (1if):



IR - Image Rotate

0ir Image as snapped (rightside up) (default)

1ir Rotate image 90 degrees to the right

2ir Rotate image 180 degrees (upside down)

3ir Rotate image 90 degrees to the left

Example:

Image Rotate set to 0ir:



Image Rotate set to 2ir:



Image Rotate set to 1ir:



Image Rotate set to 3ir:



J - JPEG Image Quality

Sets the desired quality when the JPEG image format is selected. Higher numbers result in higher quality, but larger files. Smaller numbers result in greater amounts of lossy compression, faster transmission times, lower quality, but smaller files.

(Default = 50)

- nJ Image is compressed as much as possible while preserving quality factor of n ($n = 0 - 100$)
- 0J worst quality (smallest file)
- 100J best quality (largest file)

K - Gamma Correction

Gamma measures the brightness of midtone values produced by the image. You can brighten or darken an image using gamma correction. A higher gamma correction yields an overall brighter image. The lower the setting, the darker the image. The optimal setting for text images is 50K.

- OK Gamma correction off (default)
- 50K Apply gamma correction for brightening typical document image
- nK Apply gamma correction factor n ($n = 0-1,000$)

Example:

Gamma Correction set to 0K:



Gamma Correction set to 50K:



Gamma Correction set to 255K:



L, R, T, B, M - Image Cropping

Ships a window of the image by specifying the left, right, top, and bottom pixel coordinates. Device columns are numbered 0 through 1279, and device rows are numbered 0 through 959.

- nL The left edge of the shipped image corresponds to column n of the image in memory. Range: 000 - 843. (Default = 0)
- nR The right edge of the shipped image corresponds to column $n - 1$ of the image in memory. Range: 000 - 843. (Default = all columns)
- nT The top edge of the shipped image corresponds to row n of the image in memory. Range: 000 - 639. (Default = 0)

nB The bottom edge of the shipped image corresponds to row $n - 1$ of the image in memory. Range: 000 - 639. (*Default = all rows*)

Example:

Uncropped Image:



Image Crop set to 300R:



Image Crop set to 300L:



Image Crop set to 200B:



Image Crop set to 200T:



Alternately, specify the number of pixels to cut from the outside margin of the image; thus only the center pixels are transmitted.

nM Margin: cut n columns from the left, $n + 1$ columns from the right, n rows from the top, and $n + 1$ rows from the bottom of the image. Ship the remaining center pixels. Range: 0 - 238. (*Default = 0, or full image*)

Example:

Image Crop set to 238M:



P - Protocol

Used for shipping an image. Protocol covers two features of the image data being sent to the host. It addresses the protocol used to send the data (Hmodem, which is an Xmodem 1K variant that has additional header information), and the format of the image data that is sent.

- 0P None (raw data)
- 2P None (*default for USB*)
- 3P Hmodem compressed (*default for RS232*)
- 4P Hmodem

S - Pixel Ship

Pixel Ship sizes an image in proportion to its original size. It decimates the image by shipping only certain, regularly spaced pixels.

Example: 4S would transmit every fourth pixel from every fourth line.

The smaller number of pixels shipped, the smaller the image, however, after a certain point the image becomes unusable.

- 1S ship every pixel (*default*)
- 2S ship every 2nd pixel, both horizontally and vertically
- 3S ship every 3rd pixel, both horizontally and vertically

Example:

Pixel Ship set to 1S:



Pixel Ship set to 2S:



Pixel Ship set to 3S:



Pixel Ship set to 4S:



U - Document Image Filter

Allows you to input parameters to sharpen the edges and smooth the area between the edges of text in an image. This filter should be used with gamma correction (see [page 172](#)), with the scanner in a stand, and the image captured using the command:

IMGSP1POL168W90%32D

This filter typically provides better JPEG compression than the standard E - Edge Sharpen command (see [page 175](#)). This filter also works well when shipping pure black and white images (1 bit per pixel). The optimal setting is 26U.

- 0U Document image filter off (*default*)
- 26U Apply document image filter for typical document image
- nU Apply document image filter using grayscale threshold n. Use lower numbers when the image contrast is lower. 1U will have a similar effect to setting [E - Edge Sharpen](#) (page 169) to 22e. Range: 0-255.

Example:

Document Image Filter set to 0U:



Document Image Filter set to 26U:



V - Blur Image

Smooths transitions by averaging the pixels next to the hard edges of defined lines and shaded areas in an image.

0V Don't blur (*default*)

1V Blur

Example:

Blur Image Off (0V):

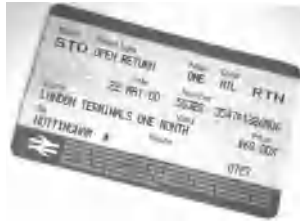

Blur Image On (1V):



W - Histogram Ship

A histogram gives a quick picture of the tonal range of an image, or key type. A low-key image has detail concentrated in the shadows; a high-key image has detail concentrated in the highlights; and an average-key image has detail concentrated in the midtones. This modifier ships the histogram for an image.

0W Don't ship histogram (*default*)

1W Ship histogram

Example:

Image used for histogram:



Histogram of image:



Image Size Compatibility

If you have applications that expect an image ship to return exactly 640x480 pixels, scan the Force VGA Resolution barcode. *Default = Native Resolution.*





Intelligent Signature Capture - IMGBOX

IMGBOX allows you to configure the size and location of a signature capture area relative to its proximity to a barcode. This allows you to tailor a signature capture area to a specific form. In order to use IMGBOX, you need a set form where the signature box location is in a known location relative to a barcode. You can input the overall size of the signature area, as well as specify how far the signature area is from the barcode, vertically and horizontally. You can also set the resolution and file format for the final output of the signature capture image.

Note: *IMGBOX commands can only be triggered by one of the following types of barcodes: PDF417, Code 39, Code 128, Aztec, Codabar, and Interleaved 2 of 5. Once one of these symbologies has been read, the image is retained for a possible IMGBOX command.*

Signature Capture Optimize

If you will be using your scanner to capture signatures frequently, you should optimize it for this purpose. However, the speed of scanning barcodes may be slowed when this mode is enabled. *Default = Off.*



Below is an example of a signature capture application. In this example, the aimer is centered over the signature capture area and the trigger is pressed. A single beep is emitted, indicating that the scanner has read a Code 128 barcode and the data has been transferred to the host. An IMGBOX command may now be sent from the host to specify the coordinates of the signature capture area below that code, and indicating that only that area containing the signature should be transferred as an image to the host.

To see this example, align the aimer with the signature area (not with the barcode), then press the trigger.



Send the following IMGBOX command string after the trigger press:

Example: IMGBOX245w37h55y.

Note: Case is not important in the command string. It is used here only for clarity.

The following image is captured:



The IMGBOX commands have many different modifiers that can be used to change the size and appearance of the signature image output by the scanner. Modifiers affect the image that is transmitted, but do not affect the image in memory. Any number of modifiers may be appended to the IMGBOX command.

Note: The IMGBOX command will return a NAK unless a window size (width and height) are specified. See [H - Height of Signature Capture Area](#) (page 179) and [W - Width of Signature Capture Area](#) (page 180).

IMGBOX Modifiers

A - Output Image Width

This option is used to size the image horizontally. If using this option, set the resolution (R) to zero.

Example: Image Width set to 200A:

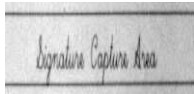
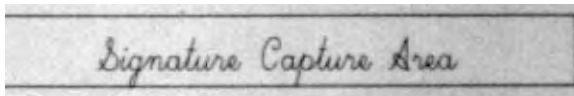

Image Width set to 600A:



B - Output Image Height

This option is used to size the image vertically. If using this option, set the resolution (R) to zero.

Example:

Image Height set to 50B:

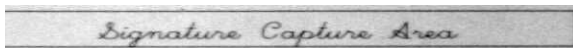
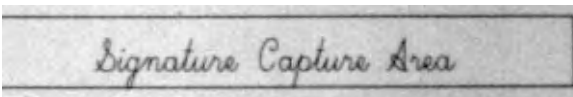

Image Height set to 100B:



D - Pixel Depth

This indicates the number of bits per pixel in the transmitted image, which defines whether it will be grayscale or black and white.

8D 8 bits per pixel, grayscale image (*default*)

1D 1 bit per pixel, black and white image

F - File Format

This option indicates the type of file format in which to save the image.

0F KIM format

1F TIFF binary

2F TIFF binary group 4, compressed

3F TIFF grayscale

4F Uncompressed Binary

5F Uncompressed grayscale

6F JPEG image (*default*)

7F Outlined image

8F BMP format

H - Height of Signature Capture Area

The height of the signature capture area must be measured in inches divided by .01. In the example, the height of the area to be captured is 3/8 inch, resulting in a value of $H = .375/0.01 = 37.5$.

Example: **IMGBOX245w37h55y**.

K - Gamma Correction

Gamma measures the brightness of midtone values produced by the image. You can brighten or darken an image using gamma correction. A higher gamma correction yields an overall brighter image. The lower the setting, the darker the image. The optimal setting for text images is 50K.

0K Gamma correction off (*default*)

50K Apply gamma correction for brightening typical document image

nK Apply gamma correction factor n ($n = 1-255$)

Example:

Gamma Correction set to 0K:



Gamma Correction set to 50K:



Gamma Correction set to 255K:

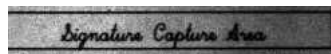

R - Resolution of Signature Capture Area

The resolution is the number of pixels that the scanner outputs per each minimum bar width. The higher the value for R, the higher the quality of the image, but also the larger the file size. Values begin at 1000. The scanner automatically inserts a

decimal point between the first and second digit. For example, use 2500 to specify a resolution of 2.5. Set to zero when using the A and B modifiers (see [A - Output Image Width](#) and [B - Output Image Height](#) on page 178).

Example: Resolution set to 0R:

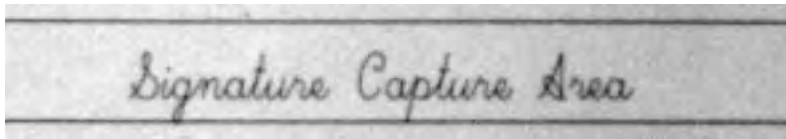

Resolution set to 100R:



Resolution set to 200R:

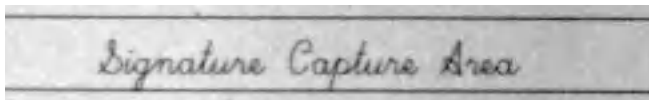

S - Barcode Aspect Ratio

All dimensions used in IMGBOX are measured as multiples of the minimum element size of the barcode. The barcode aspect ratio allows you to set the ratio of the barcode height to the narrow element width. In the example, the narrow element width is .010 inches and the barcode height is 0.400 inches, resulting in a value of $S = 0.4/0.01 = 40$.

W - Width of Signature Capture Area

The width of the signature capture area must be measured in inches divided by .01. In the example, the width of the area to be captured is 2.4 inches, resulting in a value of $W = 2.4/0.01 = 240$. (A value of 245 was used in the example to accommodate a slightly wider image area.)

Example: *IMGBOX245w37h55y*.

X - Horizontal Barcode Offset

The horizontal barcode offset allows you to offset the horizontal center of the signature capture area. Positive values move the horizontal center to the right and negative values to the left. Measurements are in multiples of the minimum bar width.

Example:

Horizontal Offset set to 75X:



Horizontal Offset set to -75X:

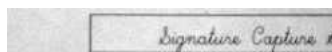

Y - Vertical Barcode Offset

The vertical barcode offset allows you to offset the vertical center of the signature capture area. Negative numbers indicate that the signature capture is above the barcode, and positive numbers indicate that the area is below the barcode. Measurements are in multiples of the minimum bar width.

Example:

Vertical Offset set to -7Y:



Vertical Offset set to 65Y:

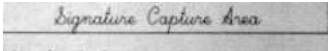

To Add a Test Code I.D. Prefix to All Symbologies

This selection allows you to turn on transmission of a Code I.D. before the decoded symbology. (See the [Symbology Charts](#), beginning on page 227 for the single character code that identifies each symbology.) This action first clears all current prefixes, then programs a Code I.D. prefix for all symbologies. This is a temporary setting that will be removed when the unit is power cycled.



PRECA2,BK2995C80!

Add Code I.D. Prefix to
All Symbologies (Temporary)

Show Software Revision

Scan the barcode below to output the current software revision, unit serial number, and other product information for both the scanner and base.



REVINF.

Show Software Revision

Test Menu

When you scan the **Test Menu On** code, then scan a programming code in this manual, the scanner displays the content of a programming code. The programming function will still occur, but in addition, the content of that programming code is output to the terminal.

Note: This feature should not be used during normal scanner operation.



TotalFreedom

TotalFreedom is an open system architecture that makes it possible for you create applications that reside on your scanner. Decoding apps and Data Formatting apps can be created using TotalFreedom. For further information about TotalFreedom, go to our website at sps.honeywell.com.

Application Plug-Ins (Apps)

Any apps that you are using can be turned off or on by scanning the following barcodes. Apps are stored in groups: Decoding, and Formatting. You can enable and disable these groups of apps by scanning that group's On or Off barcode below. You can also scan the List Apps barcode to output a list of all your apps.



Note: You must reset your device in order for the apps setting to take effect.

EZConfig for Scanning Introduction

EZConfig for Scanning provides a wide range of PC-based programming functions that can be performed on the scanner connected to your PC. EZConfig for Scanning allows you to download upgrades to the scanner's firmware, change programmed parameters, and create and print programming barcodes. Using EZConfig for Scanning, you can even save/open the programming parameters. This saved file can be e-mailed or, if required, you can create a single barcode that contains all the customized programming parameters and mail or fax that barcode to any location. Users in other locations can scan the barcode to load in the customized programming.

Configure with EZConfig for Scanning

Use the EZConfig for Scanning tool to configure your scanner online:

1. Access the Honeywell Technical Support Downloads Portal at <https://hsmftp.honeywell.com>.
2. Go to **Software > Barcode Scanners > Software > Tools and Utilities > EZConfig for Scanning > Current**.

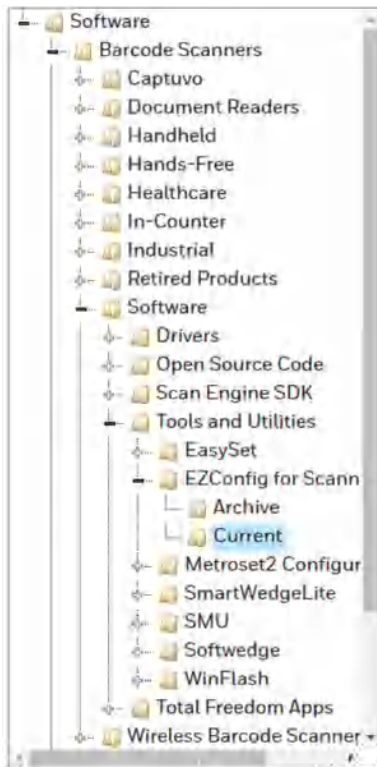

3. Download the **Setup** version of EZConfig for Scanning.
4. Open EZConfig to configure your scanner.

Reset the Factory Defaults



Caution: *This selection erases all your settings and resets the scanner to the original factory defaults. It also disables all plugins.*

If you aren't sure what programming options are in your scanner, or you've changed some options and want to restore the scanner to factory default settings, first scan the **Remove Custom Defaults** barcode, then scan **Activate Defaults**. This resets the scanner to the factory default settings.



DEFOVR.

Remove Custom Defaults



DEFAULT.

Activate Defaults

The [Menu Commands](#), beginning on page 192, list the factory default settings for each of the commands (indicated by an asterisk (*) on the programming pages).

SERIAL PROGRAMMING COMMANDS

The serial programming commands can be used in place of the programming barcodes. Both the serial commands and the programming barcodes will program the scanner. For complete descriptions and examples of each serial programming command, refer to the corresponding programming barcode in this manual.

The device must be set to an RS232 interface (see [page 10](#)). The following commands can be sent via a PC COM port using terminal emulation software.

Conventions

The following conventions are used for menu and query command descriptions:

<i>parameter</i>	A label representing the actual value you should send as part of a command.
[<i>option</i>]	An optional part of a command.
{Data}	Alternatives in a command.
bold	Names of menus, menu commands, buttons, dialog boxes, and windows that appear on the screen.

Menu Command Syntax

Menu commands have the following syntax (spaces have been used for clarity only):

Prefix [:Name:] *Tag* *SubTag* {Data} [, *SubTag* {Data}] [; *Tag* *SubTag* {Data}] [...] *Storage*

Prefix Three ASCII characters: SYN M CR (ASCII 22,77,13).

Tag A 3 character case-insensitive field that identifies the desired menu command group. For example, all RS232 configuration settings are identified with a Tag of **232**.

SubTag	A 3 character case-insensitive field that identifies the desired menu command within the tag group. For example, the SubTag for the RS232 baud rate is BAD .
Data	The new value for a menu setting, identified by the Tag and SubTag.
Storage	A single character that specifies the storage table to which the command is applied. An exclamation point (!) performs the command's operation on the device's volatile menu configuration table. A period (.) performs the command's operation on the device's non-volatile menu configuration table. Use the non-volatile table only for semi-permanent changes you want saved through a power cycle.

Query Commands

Several special characters can be used to query the device about its settings.

^ What is the default value for the setting(s).

> What is the PAP sub command.

Note: When using the **>**, all other commands will return NAK.

? What is the device's current value for the setting(s).

***** What is the range of possible values for the setting(s). (The device's response uses a dash (-) to indicate a continuous range of values. A pipe (|) separates items in a list of non-continuous values.)

:Name: Field Usage (Optional)

This command returns the query information from the scanner.

Tag Field Usage

When a query is used in place of a Tag field, the query applies to the *entire* set of commands available for the particular storage table indicated by the Storage field of the command. In this case, the SubTag and Data fields should not be used because they are ignored by the device.

SubTag Field Usage

When a query is used in place of a SubTag field, the query applies only to the subset of commands available that match the Tag field. In this case, the Data field should not be used because it is ignored by the device.

Data Field Usage

When a query is used in place of the Data field, the query applies only to the specific command identified by the Tag and SubTag fields.

Concatenation of Multiple Commands

Multiple commands can be issued within one Prefix/Storage sequence. Only the Tag, SubTag, and Data fields must be repeated for each command in the sequence. If additional commands are to be applied to the same Tag, then the new command sequence is separated with a comma (,) and only the SubTag and Data fields of the additional command are issued. If the additional command requires a different Tag field, the command is separated from previous commands by a semicolon (;).

Responses

The device responds to serial commands with one of three responses:

ACK	Indicates a good command which has been processed.
ENQ	Indicates an invalid Tag or SubTag command.
NAK	Indicates the command was good, but the Data field entry was out of the allowable range for this Tag and SubTag combination, e.g., an entry for a minimum message length of 100 when the field will only accept 2 characters.

When responding, the device echoes back the command sequence with the status character inserted directly before each of the punctuation marks (the period, exclamation point, comma, or semicolon) in the command.

Examples of Query Commands

In the following examples, a bracketed notation [] depicts a non-displayable response.

Example: What is the range of possible values for Codabar Coding Enable?

Enter: **cbrena*.**

Response: **CBRENA0-1[ACK]**

This response indicates that Codabar Coding Enable (CBRENA) has a range of values from 0 to 1 (off and on).

Example: What is the default value for Codabar Coding Enable?

Enter: **cbrena^.**

Response: **CBRENA1[ACK]**

This response indicates that the default setting for Codabar Coding Enable (CBRENA) is 1, or on.

Example: What is the device's current setting for Codabar Coding Enable?

Enter: **cbrena?.**

Response: CBRENA1[ACK]

This response indicates that the device's Codabar Coding Enable (CBRENA) is set to 1, or on.

Example: What are the device's settings for all Codabar selections?

Enter: cbr?.

**Response: CBRENA1[ACK],
SSX0[ACK],
CK20[ACK],
CCT1[ACK],
MIN2[ACK],
MAX60[ACK],
DFT[ACK].**

This response indicates that the device's Codabar Coding Enable (CBRENA) is set to 1, or on;
the Start/Stop Character (SSX) is set to 0, or Don't Transmit;
the Check Character (CK2) is set to 0, or Not Required;
concatenation (CCT) is set to 1, or Enabled;
the Minimum Message Length (MIN) is set to 2 characters;
the Maximum Message Length (MAX) is set to 60 characters;
and the Default setting (DFT) has no value.

Trigger Commands

You can activate and deactivate the scanner with serial trigger commands. First, the scanner must be put in Manual Trigger Mode by scanning a Manual Trigger Mode barcode ([page 40](#)), or by sending a serial menu command for triggering ([page 42](#)). Once the scanner is in serial trigger mode, the trigger is activated and deactivated by sending the following commands:

Activate: **SYN T CR**

Deactivate: **SYN U CR**

The scanner scans until a barcode has been read, until the deactivate command is sent, or until the serial time-out has been reached (see [Read Time-Out](#) on page 42 for a description, and the serial command on [page 198](#)).

Reset the Custom Defaults

If you want the custom default settings restored to your scanner, scan the **Activate Custom Defaults** barcode below. This resets the scanner to the custom default settings. If there are no custom defaults, it will reset the scanner to the factory default settings. Any settings that have not been specified through the custom defaults will be defaulted to the factory default settings.



DEFAULT.

Activate Custom Defaults

The charts on the following pages list the factory default settings for each of the commands (indicated by an asterisk (*) on the programming pages).

Menu Commands

Selection	Setting * Indicates default	Serial Command # Indicates a numeric entry	Page
Product Default Settings			
Set Custom Defaults	Set Custom Defaults	MNUCDP	8
	Save Custom Defaults	MNUCDS	8
Reset the Custom Defaults	Activate Custom Defaults	DEFAULT	8
Program the Interface			
Plug and Play Codes	Keyboard Wedge: IBM PC AT and Compatibles with CR suffix	PAP_AT	9
	Laptop Direct Connect with CR suffix	PAPLTD	10
	RS232 Serial Port	PAP232	10
Plug and Play Codes: RS485	IBM Port 5B Interface	PAPP5B	10
	IBM Port 9B HHBCR-1 Interface	PAP9B1	10
	IBM Port 17 Interface	PAPP17	11
	IBM Port 9B HHBCR-2 Interface	PAP9B2	11
Plug and Play Codes: IBM SurePos	USB IBM SurePos Handheld	PAPSPH	11
	USB IBM SurePos Tabletop	PAPSPT	11
Plug and Play Codes: USB	USB Keyboard (PC)	PAP124	12
	USB Keyboard (Mac)	PAP125	12
	USB Japanese Keyboard (PC)	TRMUSB134	12
	USB HID	PAP131	12
	USB Serial	TRMUSB130	12
	CTS/RTS Emulation On	USBCTS1	13
	*CTS/RTS Emulation Off	USBCTS0	13
	ACK/NAK Mode On	USBACK1	13
*ACK/NAK Mode Off	USBACK0	13	
Plug and Play Codes	Verifone Ruby Terminal	PAPRBY	13
	Gilbarco Terminal	PAPGLB	14
	Honeywell Bioptic Aux Port	PAPBIO	14
	Datalogic Magellan Aux Port	PAPMAG	14
	Wincor Nixdorf Terminal	PAPWNX	15
	Wincor Nixdorf Beetle	PAPBTL	15
	Wincor Nixdorf RS232 Mode A	PAPWMA	16

Selection	Setting * Indicates default	Serial Command # Indicates a numeric entry	Page
Program Keyboard Country	*U.S.A.	KBDCTY0	16
	Albania	KBDCTY35	16
	Azeri (Cyrillic)	KBDCTY81	16
	Azeri (Latin)	KBDCTY80	16
	Belarus	KBDCTY82	17
	Belgium	KBDCTY1	17
	Bosnia	KBDCTY33	17
	Brazil	KBDCTY16	17
	Brazil (MS)	KBDCTY59	17
	Bulgaria (Cyrillic)	KBDCTY52	17
	Bulgaria (Latin)	KBDCTY53	17
	Canada (French legacy)	KBDCTY54	17
	Canada (French)	KBDCTY18	17
	Canada (Multilingual)	KBDCTY55	17
	Croatia	KBDCTY32	17
	Czech	KBDCTY15	17
	Czech (Programmers)	KBDCTY40	18
	Czech (QWERTY)	KBDCTY39	18
	Czech (QWERTZ)	KBDCTY38	18
	Denmark	KBDCTY8	18
	Dutch (Netherlands)	KBDCTY11	18
	Estonia	KBDCTY41	18
	Faroese	KBDCTY83	18
	Finland	KBDCTY2	18
	France	KBDCTY3	18
	Gaelic	KBDCTY84	18
	Germany	KBDCTY4	18
	Greek	KBDCTY17	18
	Greek (220 Latin)	KBDCTY64	19
	Greek (220)	KBDCTY61	19
	Greek (319 Latin)	KBDCTY65	19
	Greek (319)	KBDCTY62	19
	Greek (Latin)	KBDCTY63	19
	Greek (MS)	KBDCTY66	19
	Greek (Polytonic)	KBDCTY60	19
	Hebrew	KBDCTY12	19
Hungarian (101 key)	KBDCTY50	19	

Selection	Setting * Indicates default	Serial Command # Indicates a numeric entry	Page
	Hungary	KBDCTY19	19
	Iceland	KBDCTY75	19
	Irish	KBDCTY73	19
	Italian (142)	KBDCTY56	20
	Italy	KBDCTY5	20
	Japan ASCII	KBDCTY28	20
	Kazakh	KBDCTY78	20
	Kyrgyz (Cyrillic)	KBDCTY79	20
	Latin America	KBDCTY14	20
	Latvia	KBDCTY42	20
	Latvia (QWERTY)	KBDCTY43	20
	Lithuania	KBDCTY44	20
	Lithuania (IBM)	KBDCTY45	20
	Macedonia	KBDCTY34	20
	Malta	KBDCTY74	20
	Mongolian (Cyrillic)	KBDCTY86	21
	Norway	KBDCTY9	21
	Poland	KBDCTY20	21
	Polish (214)	KBDCTY57	21
	Polish (Programmers)	KBDCTY58	21
	Portugal	KBDCTY13	21
	Romania	KBDCTY25	21
	Russia	KBDCTY26	21
	Russian (MS)	KBDCTY67	21
	Russian (Typewriter)	KBDCTY68	21
	SCS	KBDCTY21	21
	Serbia (Cyrillic)	KBDCTY37	21
	Serbia (Latin)	KBDCTY36	22
	Slovakia	KBDCTY22	22
	Slovakia (QWERTY)	KBDCTY49	22
	Slovakia (QWERTZ)	KBDCTY48	22
	Slovenia	KBDCTY31	22
	Spain	KBDCTY10	22
	Spanish variation	KBDCTY51	22
	Sweden	KBDCTY23	22
	Switzerland (French)	KBDCTY29	22
	Switzerland (German)	KBDCTY6	22

Selection	Setting * Indicates default	Serial Command # Indicates a numeric entry	Page
	Tatar	KBDCTY85	22
	Turkey F	KBDCTY27	22
	Turkey Q	KBDCTY24	23
	Ukrainian	KBDCTY76	23
	United Kingdom	KBDCTY7	23
	United Stated (Dvorak right)	KBDCTY89	23
	United States (Dvorak left)	KBDCTY88	23
	United States (Dvorak)	KBDCTY87	23
	United States (International)	KBDCTY30	23
	Uzbek (Cyrillic)	KBDCTY77	23
ALT Mode	* Off	KBDALTO	24
	3 Characters	KBDALT6	24
	4 Characters	KBDALT7	24
Keyboard Style	*Regular	KBDSTY0	24
	Caps Lock	KBDSTY1	24
	Shift Lock	KBDSTY2	24
	Automatic Caps Lock	KBDSTY6	25
	Autocaps via Num Lock	KBDSTY7	25
	Emulate External Keyboard	KBDSTY5	25
Keyboard Conversion	*Keyboard Conversion Off	KBDCNV0	25
	Convert all Characters to Upper Case	KBDCNV1	26
	Convert all Characters to Lower Case	KBDCNV2	26
Control Character Output	*Control Character Output Off	KBDNPE0	26
	Control Character Output On	KBDNPE1	26

Selection	Setting * Indicates default	Serial Command # Indicates a numeric entry	Page
Keyboard Modifiers	*Control + X Off	KBDCAS0	27
	DOS Mode Control + X	KBDCAS1	27
	Windows Mode Control + X	KBDCAS2	27
	Windows Mode Prefix/Suffix Off	KBDCAS3	27
	DOS Mode Control + X Mode On with Windows Mode Prefix/Suffix	KBDCAS4	27
	Supports ALT 3 Digit HEX Mode	KBDCAS5	27
	*Turbo Mode Off	KBDTMD0	27
	Turbo Mode On	KBDTMD1	27
	*Numeric Keypad Off	KBDNPS0	27
	Numeric Keypad On	KBDNPS1	27
	*Auto Direct Connect Off	KBDADC0	28
	Auto Direct Connect On	KBDADC1	28
Baud Rate	300 BPS	232BAD0	28
	600 BPS	232BAD1	28
	1200 BPS	232BAD2	28
	2400 BPS	232BAD3	28
	4800 BPS	232BAD4	28
	9600 BPS	232BAD5	29
	19200 BPS	232BAD6	29
	38400 BPS	232BAD7	29
	57600 BPS	232BAD8	29
	*115200 BPS	232BAD9	29
Word Length: Data Bits, Stop Bits, and Parity	7 Data, 1 Stop, Parity Even	232WRD3	29
	7 Data, 1 Stop, Parity None	232WRD0	29
	7 Data, 1 Stop, Parity Odd	232WRD6	29
	7 Data, 2 Stop, Parity Even	232WRD4	29
	7 Data, 2 Stop, Parity None	232WRD1	29
	7 Data, 2 Stop, Parity Odd	232WRD7	30
	8 Data, 1 Stop, Parity Even	232WRD5	30
	*8 Data, 1 Stop, Parity None	232WRD2	30
	8 Data, 1 Stop, Parity Odd	232WRD8	30
	8 Data, 1 Stop, Parity Mark	232WRD14	30
RS232 Receiver Time-out	Range 0 - 300 seconds *0	232LPT###	30

Selection	Setting * Indicates default	Serial Command # Indicates a numeric entry	Page
RS232 Handshaking	*RTS/CTS Off	232CTS0	31
	Flow Control, No Timeout	232CTS1	31
	Two-Direction Flow Control	232CTS2	31
	Flow Control with Timeout	232CTS3	31
	RS232 Timeout (1-5100 milliseconds)	232DEL####	31
	*XON/XOFF Off	232XON0	32
	XON/XOFF On	232XON1	31
	*ACK/NAK Off	232ACK0	32
	ACK/NAK On	232ACK1	32
Scanner-Bioptic Packet Mode	*Packet Mode Off	232PKT0	32
	Packet Mode On	232PKT2	32
Scanner-Bioptic ACK/NAK Mode	*Bioptic ACK/NAK Off	232NAK0	33
	Bioptic ACK/NAK On	232NAK1	33
Scanner-Bioptic ACK/NAK Timeout	ACK/NAK Timeout (1-30000 milliseconds) *5100	232DLK#####	33
Input/Output Selections			
Power Up Beeper	Power Up Beeper Off - Scanner	BEPPWR0	35
	*Power Up Beeper On - Scanner	BEPPWR1	35
Beep on BEL Character	Beep on BEL On	BELBEP1	35
	*Beep on BEL Off	BELBEP0	35
Trigger Click	On	BEPTRG1	36
	*Off	BEPTRG0	36
Beeper - Good Read	Off	BEPBEP0	36
	*On	BEPBEP1	36
Beeper Volume - Good Read	Off	BEPLVL0	36
	*Low (Default-Xenon XP healthcare)	BEPLVL1	36
	Medium	BEPLVL2	36
	*High (Default - Xenon XP)	BEPLVL3	37
Beeper Pitch - Good Read (Frequency)	Low (1600 Hz) (min 400 Hz)	BEPFQ11600	37
	*Medium (2700 Hz)	BEPFQ12700	37
	High (4200 Hz) (max 9000 Hz)	BEPFQ14200	37
Beeper Pitch - Error (Frequency)	*Razz (250 Hz) (min 200 Hz)	BEPFQ2800	37
	Medium (3250 Hz)	BEPFQ23250	37
	High (4200 Hz) (max 9000 Hz)	BEPFQ24200	37
Beeper Duration - Good Read	*Normal Beep	BEPBIP0	38
	Short Beep	BEPBIP1	38

Selection	Setting * Indicates default	Serial Command # Indicates a numeric entry	Page
LED - Good Read	Off	BEPLED0	38
	*On	BEPLED1	38
Number of Beeps - Good Read	(Range 1 - 9) *1	BEPRPT#	38
Number of Beeps - Error	(Range 1 - 9) *1	BEPERR#	38
Good Read Delay	*No Delay	DLYGRD0	39
	Short Delay (500 ms)	DLYGRD500	39
	Medium Delay (1000 ms)	DLYGRD1000	39
	Long Delay (1500 ms)	DLYGRD1500	39
User-Specified Good Read Delay	Range 0 - 30,000 ms	DLYGRD#####	39
Object Detection Mode	Object Detection Mode	PAPTIR	40
	*Short Range	AOSRNG1	40
	Mid Range	AOSRNG2	40
Trigger Modes	*Manual Trigger - Normal	PAPHHF	40
	Manual Trigger - Enhanced	PAPHHS	40
Trigger Toggle	*Trigger Toggle Off	TRGTGM0	41
	Trigger Toggle - Image Capture	TRGTGM1	41
	Trigger Toggle Off - Centering	TRGTGM3	41
Trigger Number	2 Quick Triggers	TRGTPC2	41
	3 Quick Triggers	TRGTPC3	41
	4 Quick Triggers	TRGTPC4	41
Trigger Timing	Trigger Timing (Range 50 - 2000) *400	TRGTTI####	41
Trigger Toggle Timeout	Trigger Toggle Timeout (Range 0 - 65) *5	TRGTGT##	42
Serial Trigger Mode	Read Time-Out (0 - 300,000 ms) *30,000	TRGSTO####	42
Presentation Mode	Presentation Mode	PAPTPR	42
Triggered Presentation Mode	Ambient Light Only	PDCLED0	43
	*Ambient and Scanner Light	PDCLED1	43
Presentation LED Behavior After Decode	*LEDs On	TRGPCK1	43
	LEDs Off	TRGPCK0	43

Selection	Setting * Indicates default	Serial Command # Indicates a numeric entry	Page
Presentation Centering	Presentation Centering On	PDCWIN1	44
	*Presentation Centering Off	PDCWIN0	44
	Left of Presentation Centering Window (*40%)	PDCLFT###	45
	Right of Presentation Centering Window (*60%)	PDCRGT###	45
	Top of Presentation Centering Window (*40%)	PDCTOP###	45
	Bottom of Presentation Centering Window (*60%)	PDCBOT###	45
Poor Quality Codes	Poor Quality 1D Reading On	DECLDI1	45
	*Poor Quality 1D Reading Off	DECLDIO	45
	*Poor Quality PDF Reading On	PDFXPR10	45
	Poor Quality PDF Reading Off	PDFXPRO	46
	Low Resolution PDF Codes On	PDFDMI1	46
	*Low Resolution PDF Codes Off	PDFDMIO	46
CodeGate	*CodeGate Off Out-of-Stand	AOSCGD0.	46
	CodeGate On Out-of-Stand	AOSCGD1.	47
Hands Free Time-Out	Range (0 - 300,000 ms) 5000 ms	TRGPTO#####	47
Reread Delay	Short (500 ms)	DLYRRD500	47
	*Medium (750 ms)	DLYRRD750	47
	Long (1000 ms)	DLYRRD1000	47
	Extra Long (2000 ms)	DLYRRD2000	47
User-Specified Reread Delay	Range 0 - 30,000 ms	DLYRRD#####	48
2D Reread Delay	*2D Reread Delay Off	DLY2RRO	48
	Short (1000ms)	DLY2RR1000	48
	Medium (2000ms)	DLY2RR2000	48
	Long (3000ms)	DLY2RR3000	48
	Extra Long (4000ms)	DLY2RR4000	48
Character Activation Mode	*Off	HSTCEN0	48
	On	HSTCEN1	48
	Activation Character (Range 0-255) *12 [DC2]	HSTACH###	49
	Do Not End Character Activation After Good Read	HSTCGD0	49
	End Character Activation After Good Read	HSTCGD1	49
	Character Activation Timeout (Range 1 - 300,000) *30,000 ms	HSTCDT#####	50

Selection	Setting * Indicates default	Serial Command # Indicates a numeric entry	Page
Character Deactivation Mode	*Off	HSTDENO	50
	On	HSTDEN1	50
	Deactivation Character (Range 0-255) *14 [DC4]	HSTDCH###	50
Illumination Lights	*Lights On	SCNLED1	51
	Lights Off	SCNLED0	51
Aimer Delay	1 millisecond	SCNDLY1	51
	250 milliseconds	SCNDLY250	51
	500 milliseconds	SCNDLY500	51
	*Off (no delay)	SCNDLY0	51
User-Specified Aimer Delay	Range 0 - 4,000 ms	SCNDLY####	52
Aimer Mode	Off	SCNAIM0	52
	*Interlaced	SCNAIM2	52
Presentation Aimer Mode	Interlaced	PDCAIM2	53
	*Off	PDCAIM0	53
Enhanced Object Detection	*Normal Object Detection	TRGOPE0	53
	Enhanced Object Detection	TRGOPE1	53
Single Code Centering	Single Code Centering	DECWIN1;DECTOP49;DECBOT51;DECRGT51;DECLFT49	54
Centering Window	Centering On	DECWIN1	55
	*Centering Off	DECWIN0	55
	Left of Centering Window (*40%)	DECLFT###	56
	Right of Centering Window (*60%)	DECRGT###	56
	Top of Centering Window (*40%)	DECTOP###	55
	Bottom of Centering Window (*60%)	DECBOT###	56
Preferred Symbology	On	PRFENA1	56
	*Off	PRFENA0	56
	High Priority Symbology	PRFCOD##	57
	Low Priority Symbology	PRFBLK##	57
	Preferred Symbology Timeout (Range 100-3000) *500	PRFPTO####	57
	Preferred Symbology Default	PRFDFT	57
Output Sequence Editor	Enter Output Sequence	SEQBLK	59
	Add Prefix to Complete Output Sequences	SEQPRE	59
	Add Suffix to Complete Output Sequences	SEQSUF	59
	Add Separators to Complete Output Sequences	SEQSEP	59

Selection	Setting * Indicates default	Serial Command # Indicates a numeric entry	Page
	Terminate String	FF	59
Partial Sequence	Transmit Partial Output Sequence	SEQTTS1	59
	Add Prefix to Partial Output Sequences	SEQIPR	59
	Add Suffix to Partial Output Sequences	SEQISU	59
	Add Separators to Partial Output Sequences	SEQISE	59
	Terminate String	FF	59
	Define Satisfactory Subsets	SEQSAT	59
	Timeout for SEQSAT	SEQTIM	59
	*Discard Partial Output Sequence	SEQTTS0	64
	Default Output Sequence	SEQDFT	67
Require Output Sequence	Required	SEQ_EN2	67
	On/Not Required	SEQ_EN1	67
	*Off	SEQ_EN0	67
Good Read Tone - Output Sequences	Good Read Beep - Each Code in Sequence	BEPSIN0	67
	*Good Read Click - Each Code in Sequence	BEPSIN1	68
	Good Read Beep - Partial Sequence Output	BEPISE0	68
	*Error Tone - Partial Sequence Output	BEPISE1	68
Multiple Symbols	On	SHOTGN1	67
	*Off	SHOTGN0	67
No Read	On	SHWNRD1	68
	*Off	SHWNRD0	68
Video Reverse	Video Reverse Only	VIDREV1	69
	Video Reverse and Standard Barcodes	VIDREV2	69
	*Video Reverse Off	VIDREV0	69
Working Orientation	*Upright	ROTATN0	70
	Vertical, Bottom to Top (Rotate CCW 90°)	ROTATN1	70
	Upside Down	ROTATN2	70
	Vertical, Top to Bottom (Rotate CW 90°)	ROTATN3	70
Optimized Scanning for Tobacco Products	European Tobacco Products	PAPTBE	71
	Russian Tobacco Products	PAPTBR	71
	European & Tobacco Products	PAPTBC	71

Selection	Setting * Indicates default	Serial Command # Indicates a numeric entry	Page
Prefix/Suffix Selections			
Add CR Suffix to All Symbologies		VSUF <code>CR</code>	75
Prefix	Add Prefix	PREBK2##	75
	Clear One Prefix	PRECL2	75
	Clear All Prefixes	PRECA2	75
Suffix	Add Suffix	SUFBK2##	75
	Clear One Suffix	SUFCL2	75
	Clear All Suffixes	SUFCA2	75
Function Code Transmit	*Enable	RMVFNC0	76
	Disable	RMVFNC1	76
Intercharacter Delay	Range 0 - 5000 (5ms increments)	DLYCHR####	76
User Specified Intercharacter Delay	Delay Length 0 - 5000 (5ms increments)	DLYCRX####	77
	Character to Trigger Delay	DLY_XX##	77
Interfunction Delay	Range 0 - 5000 (5ms increments)	DLYFNC####	77
Intermessage Delay	Range 0 - 5000 (5ms increments)	DLYMSG####	78
Data Formatter Selections			
Data Format Editor	*Default Data Format (None)	DFMDF3	80
	Show Data Format Settings	DFMBK3?	80
	Enter Data Format	DFMBK3##	81
	Clear One Data Format	DFMCL3	81
	Clear All Data Formats	DFMCA3	81
Data Formatter	Data Formatter Off	DFM_EN0	95
	*Data Formatter On, Not Required, Keep Prefix/Suffix	DFM_EN1	96
	Data Format Required, Keep Prefix/Suffix	DFM_EN2	96
	Data Formatter On, Not Required, Drop Prefix/Suffix	DFM_EN3	96
	Data Format Required, Drop Prefix/Suffix	DFM_EN4	96
Data Format Non-Match Error Tone	*Data Format Non-Match Error Tone On	DFMDECO	96
	Data Format Non-Match Error Tone Off	DFMDEC1	97

Selection	Setting * Indicates default	Serial Command # Indicates a numeric entry	Page
Primary/Alternate Data Formats	Primary Data Format	ALTFNM0	97
	Data Format 1	ALTFNM1	97
	Data Format 2	ALTFNM2	97
	Data Format 3	ALTFNM3	97
Single Scan Data Format Change	Single Scan-Primary Data Format	VSAF_0	97
	Single Scan-Data Format 1	VSAF_1	98
	Single Scan-Data Format 2	VSAF_2	98
	Single Scan-Data Format 3	VSAF_3	98
Symbologies			
All Symbologies	All Symbologies Off	ALLENA0	100
Codabar	Default All Codabar Settings	CBRDFT	100
	Off	CBRENA0	100
	*On	CBRENA1	100
Codabar Start/Stop Char.	*Don't Transmit	CBRSSX0	101
	Transmit	CBRSSX1	101
Codabar Check Char.	*No Check Char.	CBRCK20	101
	Validate, But Don't Transmit	CBRCK21	101
	Validate, and Transmit	CBRCK22	101
Codabar Concatenation	*Off	CBRCCT0	102
	On	CBRCCT1	102
	Require	CBRCCT2	102
Codabar Message Length	Minimum (2 - 60) *4	CBRMIN##	102
	Maximum (2 - 60) *60	CBRMAX##	102
Code 39	Default All Code 39 Settings	C39DFT	103
	Off	C39ENA0	103
	*On	C39ENA1	103
Code 39 Start/Stop Char.	*Don't Transmit	C39SSX0	103
	Transmit	C39SSX1	103
Code 39 Check Char.	*No Check Char.	C39CK20	103
	Validate, But Don't Transmit	C39CK21	103
	Validate, and Transmit	C39CK22	103
Code 39 Message Length	Minimum (0 - 48) *0	C39MIN##	104
	Maximum (0 - 48) *48	C39MAX##	104

Selection	Setting * Indicates default	Serial Command # Indicates a numeric entry	Page
Code 39 Append	*Off	C39APPO	104
	On	C39APP1	104
Code 32 Pharmaceutical (PARAF)	*Off	C39B320	105
	On	C39B321	105
Code 39 Full ASCII	*Off	C39ASCO	105
	On	C39ASC1	105
	Code 39 Code Page	C39DCP	105
Interleaved 2 of 5	Default All Interleaved 2 of 5 Settings	I25DFT	106
	Off	I25ENAO	106
	*On	I25ENA1	106
Interleaved 2 of 5 Check Digit	*No Check Digit	I25CK20	106
	Validate, But Don't Transmit	I25CK21	106
	Validate and Transmit	I25CK22	106
Interleaved 2 of 5 Message Length	Minimum (2 - 80) *4	I25MIN##	107
	Maximum (2 - 80) *80	I25MAX##	107
	*FEBRABAN Decode Off	I25PAY0	107
	FEBRABAN Decode On	I25PAY1	107
NEC 2 of 5	Default All NEC 2 of 5 Settings	N25DFT	108
	Off	N25ENAO	108
	*On	N25ENA1	108
NEC 2 of 5 Check Digit	*No Check Digit	N25CK20	108
	Validate, But Don't Transmit	N25CK21	108
	Validate and Transmit	N25CK22	108
NEC 2 of 5 Message Length	Minimum (2 - 80) *4	N25MIN##	109
	Maximum (2 - 80) *80	N25MAX##	109
Code 93	Default All Code 93 Settings	C93DFT	109
	Off	C93ENAO	109
	*On	C93ENA1	109
Code 93 Message Length	Minimum (0 - 80) *0	C93MIN##	109
	Maximum (0 - 80) *80	C93MAX##	109
Code 93 Append	On	C93APP1	110
	*Off	C93APPO	110
Code 93 Code Page	Code 93 Code Page	C93DCP	110

Selection	Setting * Indicates default	Serial Command # Indicates a numeric entry	Page
Straight 2 of 5 Industrial	Default All Straight 2 of 5 Industrial Settings	R25DFT	111
	*Off	R25ENAO	111
	On	R25ENA1	111
Straight 2 of 5 Industrial Message Length	Minimum (1 - 48) *4	R25MIN##	111
	Maximum (1 - 48) *48	R25MAX##	111
Straight 2 of 5 IATA	Default All Straight 2 of 5 IATA Settings	A25DFT	112
	*Off	A25ENAO	112
	On	A25ENA1	112
Straight 2 of 5 IATA Redundancy	Range (0 - 10) *0	A25VOT##	112
Straight 2 of 5 IATA Message Length	Minimum (1 - 48) *4	A25MIN##	112
	Maximum (1 - 48) *48	A25MAX##	112
Matrix 2 of 5	Default All Matrix 2 of 5 Settings	X25DFT	113
	*Off	X25ENAO	113
	On	X25ENA1	113
Matrix 2 of 5 Message Length	Minimum (1 - 80) *4	X25MIN##	113
	Maximum (1 - 80) *80	X25MAX##	113
Code 11	Default All Code 11 Settings	C11DFT	114
	*Off	C11ENAO	114
	On	C11ENA1	114
Code 11 Check Digits Required	1 Check Digit	C11CK20	114
	*2 Check Digits	C11CK21	114
Code 11 Message Length	Minimum (1 - 80) *4	C11MIN##	114
	Maximum (1 - 80) *80	C11MAX##	114
Code 128	Default All Code 128 Settings	128DFT	115
	Off	128ENAO	115
	*On	128ENA1	115
ISBT Concatenation	*Off	ISBENAO	115
	On	ISBENA1	115
Code 128 Redundancy	Range (0 - 10) *0	128VOT##	115
Code 128 Message Length	Minimum (0 - 80) *0	128MIN##	116
	Maximum (0 - 80) *80	128MAX##	116
Code 128 Append	On	128APP1	116
	*Off	128APPO	116
Code 128 Code Page	Code 128 Code Page (*2)	128DCP##	116

Selection	Setting * Indicates default	Serial Command # Indicates a numeric entry	Page
GS1-128	Default All GS1-128 Settings	GS1DFT	117
	*On	GS1ENA1	117
	Off	GS1ENA0	117
GS1-128 Message Length	Minimum (1 - 80) *1	GS1MIN##	117
	Maximum (0 - 80) *80	GS1MAX##	117
Telepen	Default All Telepen Settings	TELDFT	118
	*Off	TELENA0	118
	On	TELENA1	118
Telepen Output	*AIM Telepen Output	TELOLD0	118
	Original Telepen Output	TELOLD1	118
Telepen Message Length	Minimum (1 - 60) *1	TELMIN##	118
	Maximum (1 - 60) *60	TELMAX##	118
UPC-A	Default All UPC-A Settings	UPADFT	119
	Off	UPBENA0	119
	*On	UPBENA1	119
UPC-A Check Digit	Off	UPACKX0	119
	*On	UPACKX1	119
UPC-A Number System	Off	UPANSX0	120
	*On	UPANSX1	120
UPC-A 2 Digit Addenda	*Off	UPAAD20	120
	On	UPAAD21	120
UPC-A 5 Digit Addenda	*Off	UPAAD50	120
	On	UPAAD51	120
UPC-A Addenda Required	*Not Required	UPAARQ0	120
	Required	UPAARQ1	120
Addenda Timeout	Range (0 - 500) *120	DLYADD#####	121
UPC-A Addenda Separator	Off	UPAADS0	121
	*On	UPAADS1	121
UPC-A/EAN-13 with Extended Coupon Code	*Off	CPNENA0	121
	Allow Concatenation	CPNENA1	121
	Require Concatenation	CPNENA2	121
Addenda Timeout	Range (0 - 500) *120	DLYADD#####	122
Coupon GS1 DataBar Output	*GS1 Output Off	CPNGS10	122
	GS1 Output On	CPNGS11	122

Selection	Setting * Indicates default	Serial Command # Indicates a numeric entry	Page
UPC-E0	Default All UPC-E Settings	UPEDFT	123
	Off	UPEEN00	123
	*On	UPEEN01	123
UPC-E0 Expand	*Off	UPEEXP0	123
	On	UPEEXP1	123
UPC-E0 Addenda Required	Required	UPEARQ1	123
	*Not Required	UPEARQ0	123
Addenda Timeout	Range (0 - 500) *120	DLYADD#####	124
UPC-E0 Addenda Separator	*On	UPEADS1	124
	Off	UPEADS0	124
UPC-E0 Check Digit	Off	UPECKX0	124
	*On	UPECKX1	124
UPC-E0 Leading Zero	Off	UPENSX0	125
	*On	UPENSX1	125
UPC-E0 Addenda	2 Digit Addenda On	UPEAD21	125
	*2 Digit Addenda Off	UPEAD20	125
	5 Digit Addenda On	UPEAD51	125
	*5 Digit Addenda Off	UPEAD50	125
UPC-E1	*Off	UPEEN10	125
	On	UPEEN11	125
EAN/JAN-13	Default All EAN/ JAN Settings	E13DFT	126
	Off	E13ENAO	126
	*On	E13ENA1	126
Convert UPC-A to EAN-13	UPC-A Converted to EAN-13	UPAENAO	126
	*Do not Convert UPC-A	UPAENA1	126
EAN/JAN-13 Check Digit	Off	E13CKX0	127
	*On	E13CKX1	127
EAN/JAN-13 Addenda	2 Digit Addenda On	E13AD21	127
	*2 Digit Addenda Off	E13AD20	127
	5 Digit Addenda On	E13AD51	127
	*5 Digit Addenda Off	E13AD50	127
EAN/JAN-13 Addenda Required	*Not Required	E13ARQ0	127
	Required	E13ARQ1	127
EAN-13 Beginning with 290 Addenda Required	*Don't Require 5 Digit Addenda	ARQ2900	128
	Require 5 Digit Addenda	ARQ2901	128

Selection	Setting * Indicates default	Serial Command # Indicates a numeric entry	Page
EAN-13 Beginning with 378/379 Addenda Required	*Don't Require Addenda	ARQ3780	128
	Require 2 Digit Addenda	ARQ3781	128
	Require 5 Digit Addenda	ARQ3782	128
	Require 2 or 5 Digit Addenda	ARQ3783	128
EAN-13 Beginning with 414/419 Addenda Required	*Don't Require Addenda	ARQ4140	129
	Require 2 Digit Addenda	ARQ4141	129
	Require 5 Digit Addenda	ARQ4142	129
	Require 2 or 5 Digit Addenda	ARQ4143	129
EAN-13 Beginning with 434/439 Addenda Required	*Don't Require Addenda	ARQ4340	130
	Require 2 Digit Addenda	ARQ4341	130
	Require 5 Digit Addenda	ARQ4342	130
	Require 2 or 5 Digit Addenda	ARQ4343	130
EAN-13 Beginning with 977 Addenda Required	*Don't Require 2 Digit Addenda	ARQ9770	130
	Require 2 Digit Addenda	ARQ9771	130
EAN-13 Beginning with 978 Addenda Required	*Don't Require 5 Digit Addenda	ARQ9780	131
	Require 5 Digit Addenda	ARQ9781	131
EAN-13 Beginning with 979 Addenda Required	*Don't Require 5 Digit Addenda	ARQ9790	131
	Require 5 Digit Addenda	ARQ9791	131
Addenda Timeout	Range (0 - 500) *120	DLYADD#####	132
EAN/JAN-13 Addenda Separator	Off	E13ADS0	132
	*On	E13ADS1	132
ISBN Translate	*Off	E13ISB0	133
	On	E13ISB1	133
EAN/JAN-8	Default All EAN/ JAN-8 Settings	EA8DFT	133
	Off	EA8ENAO	133
	*On	EA8ENA1	133
EAN/JAN-8 Check Digit	Off	EA8CKX0	133
	*On	EA8CKX1	133
EAN/JAN-8 Addenda	*2 Digit Addenda Off	EA8AD20	134
	2 Digit Addenda On	EA8AD21	134
	*5 Digit Addenda Off	EA8AD50	134
	5 Digit Addenda On	EA8AD51	134
EAN/JAN-8 Addenda Required	*Not Required	EA8ARQ0	134
	Required	EA8ARQ1	134
Addenda Timeout	Range (0 - 500) *120	DLYADD#####	134
EAN/JAN-8 Addenda Separator	Off	EA8ADS0	135
	*On	EA8ADS1	135

Selection	Setting * Indicates default	Serial Command # Indicates a numeric entry	Page
MSI	Default All MSI Settings	MSIDFT	135
	*Off	MSIENAO	135
	On	MSIENA1	135
MSI Check Character	*Validate Type 10, but Don't Transmit	MSICHK0	136
	Validate Type 10 and Transmit	MSICHK1	136
	Validate 2 Type 10 Chars, but Don't Transmit	MSICHK2	136
	Validate 2 Type 10 Chars and Transmit	MSICHK3	136
	Validate Type 11 then Type 10 Char, but Don't Transmit	MSICHK4	136
	Validate Type 11 then Type 10 Char and Transmit	MSICHK5	136
	Disable MSI Check Characters	MSICHK6	136
MSI Message Length	Minimum (4 - 48) *4	MSIMIN##	137
	Maximum (4 - 48) *48	MSIMAX##	137
GS1 DataBar Omnidirectional	Default All GS1 DataBar Omnidirectional Settings	RSSDFT	137
	Off	RSENAO	137
	*On	RSENA1	137
GS1 DataBar Limited	Default All GS1 DataBar Limited Settings	RSLDFT	138
	Off	RSENAO	138
	*On	RSENA1	138
GS1 DataBar Expanded	Default All GS1 DataBar Expanded Settings	RSEDFT	138
	Off	RSENAO	138
	*On	RSENA1	138
GS1 DataBar Expanded Msg. Length	Minimum (4 - 74) *4	RSEMIN##	138
	Maximum (4 - 74) *74	RSEMAX##	138
Trioptic Code	*Off	TRIENAO	139
	On	TRIENA1	139
Codablock A	Default All Codablock A Settings	CBADFT	139
	*Off	CBAENAO	139
	On	CBAENA1	139
Codablock A Msg. Length	Minimum (1 - 600) *1	CBAMIN###	140
	Maximum (1 - 600) *600	CBAMAX###	140

Selection	Setting * Indicates default	Serial Command # Indicates a numeric entry	Page
Codablock F	Default All Codablock F Settings	CBFDFT	140
	*Off	CBFENA0	140
	On	CBFENA1	140
Codablock F Msg. Length	Minimum (1 - 2048) *1	CBFMIN####	140
	Maximum (1 - 2048) *2048	CBFMAX####	140
Label Code	On	LBLENA1	141
	*Off	LBLENA0	141
PDF417	Default All PDF417 Settings	PDFDFT	141
	*On	PDFENA1	141
	Off	PDFENA0	141
PDF417 Msg. Length	Minimum (1-2750) *1	PDFMIN####	142
	Maximum (1-2750) *2750	PDFMAX####	142
MacroPDF417	*On	PDFMAC1	142
	Off	PDFMAC0	142
MicroPDF417	Default All Micro PDF417 Settings	MPDDFT	142
	On	MPDENA1	142
	*Off	MPDENA0	142
MicroPDF417 Msg. Length	Minimum (1-366) *1	MPDMIN###	143
	Maximum (1-366) *366	MPDMAX###	143
GS1 Composite Codes	On	COMENA1	143
	*Off	COMENA0	143
UPC/EAN Version	On	COMUPC1	144
	*Off	COMUPC0	144
GS1 Composite Codes Msg. Length	Minimum (1-2435) *1	COMMIN####	144
	Maximum (1-2435) *2435	COMMAX####	144
GS1 Emulation	GS1-128 Emulation	EANEMU1	144
	GS1 DataBar Emulation	EANEMU2	143
	GS1 Code Expansion Off	EANEMU3	145
	EAN8 to EAN13 Conversion	EANEMU4	145
	*GS1 Emulation Off	EANEMU0	145
TCIF Linked Code 39	On	T39ENA1	145
	*Off	T39ENA0	145
QR Code	Default All QR Code Settings	QRCDFT	146
	*On	QRCENA1	146
	Off	QRCENA0	146
QR Code Msg. Length	Minimum (1-7089) *1	QRCMIN####	146
	Maximum (1-7089) *7089	QRCMAX####	146

Selection	Setting * Indicates default	Serial Command # Indicates a numeric entry	Page
QR Code Append	*One Scan	QRCAPP1	146
	Swipe	QRCAPP2	146
	Point & Shoot	QRCAPP3	146
	Off	QRCAPP0	146
QR Code Page	QR Code Page (*3)	QRCDCP##	147
Prohibit QR Code with Web Link	*On	QRCWEB1	148
	Off	QRCWEB0	148
DotCode	Default All DotCode Settings	DOTDFT	148
	On	DOTENA1	148
	*Off	DOTENA0	148
Poor Quality DotCodes	Poor Quality DotCodes On	DOTEXS1	148
	*Poor Quality DotCodes Off	DOTEXS0	148
DotCode Msg. Length	Minimum (1- 2400) *1	DOTMIN####	149
	Maximum (1- 2400) *2400	DOTMAX####	149
Digimarc Barcode	Decoder Attempts (0-10) *3	DIGSTR##	149
	Off	DIGENA0	149
	On	DIGENA1	149
	Uses ID Decoder then Both Decoders	DIGENA2	149
	*Uses Digimarc Decoder then Both Decoders	DIGENA3	149
	Uses ID Decoder then Alternates Decoders	DIGENA4	149
	Uses Digimarc Decoder then Alternates Decoders	DIGENA5	149
Data Matrix	Default All Data Matrix Settings	IDMDFT	149
	*On	IDMENA1	149
	Off	IDMENA0	149
Direct Part Marking (DPM) Decoding	Dotpeen DPM Decoding	DPMENA1	151
	*Disable DPM Decoding	DPMENA0	151
	Reflective (Etched) DPM Decoding	DPMENA2	151
Data Matrix Msg. Length	Minimum (1-3116) *1	IDMMIN####	152
	Maximum (1-3116) *3116	IDMMAX####	152
Data Matrix Code Page	Data Matrix Code Page (*51)	IDMDCP##	152
MaxiCode	Default All MaxiCode Settings	MAXDFT	152
	On	MAXENA1	152
	*Off	MAXENA0	152

Selection	Setting * Indicates default	Serial Command # Indicates a numeric entry	Page
MaxiCode Msg. Length	Minimum (1-150) *1	MAXMIN###	153
	Maximum (1-150) *150	MAXMAX###	153
Aztec Code	Default All Aztec Code Settings	AZTDFT	153
	*On	AZTENA1	153
	Off	AZTENA0	153
Aztec Code Msg. Length	Minimum (1-3832) *1	AZTMIN####	153
	Maximum (1-3832) *3832	AZTMAX####	153
Aztec Append	*On	AZTAPP1	154
	Off	AZTAPP0	154
Aztec Code Page	Aztec Code Page (*51)	AZTDCP##	154
Chinese Sensible (Han Xin) Code	Default All Han Xin Code Settings	HX_DFT	154
	On	HX_ENA1	154
	*Off	HX_ENA0	154
Chinese Sensible (Han Xin) Code Msg. Length	Minimum (1-7833) *1	HX_MIN####	155
	Maximum (1-7833) *7833	HX_MAX####	155
Postal Codes - 2D			
2D Postal Codes	*Off	POSTAL0	155
Single 2D Postal Codes	Australian Post On	POSTAL1	155
	British Post On	POSTAL7	155
	Canadian Post On	POSTAL30	155
	Intelligent Mail Barcode On	POSTAL10	156
	Japanese Post On	POSTAL3	156
	KIX Post On	POSTAL4	156
	Planet Code On	POSTAL5	156
	Postal-4i On	POSTAL9	156
	Postnet On	POSTAL6	156
	Postnet with B and B' Fields On	POSTAL11	156
InfoMail On	POSTAL2	156	
Combination 2D Postal Codes	InfoMail and British Post On	POSTAL8	156
	Intelligent Mail Barcode and Postnet with B and B' Fields On	POSTAL20	157
	Postnet and Postal-4i On	POSTAL14	157
	Postnet and Intelligent Mail Barcode On	POSTAL16	157
	Postal-4i and Intelligent Mail Barcode On	POSTAL17	157
	Postal-4i and Postnet with B and B' Fields On	POSTAL19	157
Planet and Postnet On	POSTAL12	157	

Selection	Setting * Indicates default	Serial Command # Indicates a numeric entry	Page
	Planet and Postnet with B and B' Fields On	POSTAL18	157
	Planet and Postal-4i On	POSTAL13	157
	Planet and Intelligent Mail Barcode On	POSTAL15	157
	Planet, Postnet, and Postal-4i On	POSTAL21	157
	Planet, Postnet, and Intelligent Mail Barcode On	POSTAL22	158
	Planet, Postal-4i, and Intelligent Mail Barcode On	POSTAL23	158
	Postnet, Postal-4i, and Intelligent Mail Barcode On	POSTAL24	158
	Planet, Postal-4i, and Postnet with B and B' Fields On	POSTAL25	158
	Planet, Intelligent Mail Barcode, and Postnet with B and B' Fields On	POSTAL26	158
	Postal-4i, Intelligent Mail Barcode, and Postnet with B and B' Fields On	POSTAL27	158
	Planet, Postal-4i, Intelligent Mail Barcode, and Postnet On	POSTAL28	158
	Planet, Postal-4i, Intelligent Mail Barcode, and Postnet with B and B' Fields On	POSTAL29	158
Planet Code Check Digit	Transmit	PLNCKX1	159
	*Don't Transmit	PLNCKX0	159
Postnet Check Digit	Transmit	NETCKX1	159
	*Don't Transmit	NETCKX0	159
Australian Post Interpretation	*Bar Output	AUSINT0	159
	Numeric N Table	AUSINT1	160
	Alphanumeric C Table	AUSINT2	160
	Combination N and C Tables	AUSINT3	160
Postal Codes - Linear			
China Post (Hong Kong 2 of 5)	Default All China Post (Hong Kong 2 of 5) Settings	CPCDFT	160
	*Off	CPCENA0	160
	On	CPCENA1	160
China Post (Hong Kong 2 of 5) Msg. Length	Minimum (2 - 80) *4	CPCMIN##	160
	Maximum (2 - 80) *80	CPCMAX##	160

Selection	Setting * Indicates default	Serial Command # Indicates a numeric entry	Page
Korea Post	Default All Korea Post Settings	KPCDFT	161
	*Off	KPCENA0	161
	On	KPCENA1	161
Korea Post Msg. Length	Minimum (2 - 80) *4	KPCMIN##	161
	Maximum (2 - 80) *48	KPCMAX##	161
Korea Post Check Digit	Transmit Check Digit	KPCCHK1	161
	*Don't Transmit Check Digit	KPCCHK0	161
Imaging Default Commands			
Image Snap	Default all Imaging Commands	IMGDFT	163
	Imaging Style - Decoding	SNPSTY0	164
	*Imaging Style - Photo	SNPSTY1	164
	Imaging Style - Manual	SNPSTY2	164
	Beeper On	SNPBEP1	164
	*Beeper Off	SNPBEP0	164
	*Wait for Trigger Off	SNPTRG0	165
	Wait for Trigger On	SNPTRG1	165
	*LED State - Off	SNPLED0	165
	LED State - On	SNPLED1	165
	Exposure (1-7874 microseconds) *7874	SNPEXP	165
	*Gain - None	SNPGAN1	166
	Gain - Medium	SNPGAN2	166
	Gain - Heavy	SNPGAN4	166
	Gain - Maximum	SNPGAN8	166
	Target White Value (0-255) *125	SNPWHT###	166
	Delta for Acceptance (0-255) *25	SNPDEL###	166
	Update Tries (0-10) *6	SNPTRY##	167
Target Set Point Percentage (1-99) *50	SNPPCT##	167	
Image Ship	*Infinity Filter - Off	IMGINFO	168
	Infinity Filter - On	IMGINF1	168
	*Compensation Off	IMGCOR0	168
	Compensation On	IMGCOR1	168
	*Pixel Depth - 8 bits/pixel (grayscale)	IMGBPP8	168
	Pixel Depth - 1 bit/pixel (B&W)	IMGBPP1	168
	*Don't Sharpen Edges	IMGEDG0	169
	Sharpen Edges (0-23)	IMGEDG##	169

Selection	Setting * Indicates default	Serial Command # Indicates a numeric entry	Page
	*File Format - JPEG	IMGFMT6	169
	File Format - KIM	IMGFMT0	169
	File Format - TIFF binary	IMGFMT1	169
	File Format - TIFF binary group 4, compressed	IMGFMT2	169
	File Format - TIFF grayscale	IMGFMT3	169
	File Format - Uncompressed binary	IMGFMT4	169
	File Format - Uncompressed grayscale	IMGFMT5	169
	File Format - BMP	IMGFMT8	169
	*Histogram Stretch Off	IMGHIS0	170
	Histogram Stretch On	IMGHIS1	170
	*Noise Reduction Off	IMGFSP0	171
	Noise Reduction On	IMGFSP1	171
	Invert Image around X axis	IMGNVX1	170
	Invert Image around Y axis	IMGNVY1	170
	Rotate Image none	IMGROTO	171
	Rotate Image 90° right	IMGROT1	171
	Rotate Image 180° right	IMGROT2	171
	Rotate Image 90° left	IMGROT3	171
	JPEG Image Quality (0-100) *50	IMGJQF###	172
	*Gamma Correction Off	IMGGAM0	172
	Gamma Correction On (0-1000)	IMGGAM###	172
	Image Crop - Left (0-843) *0	IMGWNL###	172
	Image Crop - Right (0-843) *843	IMGWNR###	172
	Image Crop - Top (0-639) *0	IMGWNT###	172
	Image Crop - Bottom (0-639) *639	IMGWNB###	173
	Image Crop - Margin (1-238) *0	IMGMAR###	173
	Protocol - None (raw)	IMGXFR0	173
	Protocol - None (default USB)	IMGXFR2	173
	Protocol - Hmodem Compressed (default RS232)	IMGXFR3	173
	Protocol - Hmodem	IMGXFR4	173
	*Ship Every Pixel	IMGSUB1	174
	Ship Every 2nd Pixel	IMGSUB2	174
	Ship Every 3rd Pixel	IMGSUB3	174
	*Document Image Filter Off	IMGUSH0	174

Selection	Setting * Indicates default	Serial Command # Indicates a numeric entry	Page
	Document Image Filter On (0-255)	IMGUSH###	174
	*Don't Ship Histogram	IMGHST0	175
	Ship Histogram	IMGHST1	175
Image Size Compatibility	Force VGA Resolution	IMGVGA1	175
	*Native Resolution	IMGVGA0	176
Intelligent Signature Capture	Optimize On	DECBND1	176
	*Optimize Off	DECBND0	176
Utilities			
Add Code I.D. Prefix to All Symbologies (Temporary)		PRECA2,BK2995C80!	183
Show Software Revision		REVINF	183
Test Menu	On	TSTMNU1	184
	*Off	TSTMNU0	184
Application Plug-Ins (Apps)	*Decoding Apps On	PLGDCE1	184
	Decoding Apps Off	PLGDCE0	184
	*Formatting Apps On	PLGFOE1	184
	Formatting Apps Off	PLGFOE0	184
	List Apps	PLGINF	184
Reset the Factory Defaults	Remove Custom Defaults	DEFOVR	186
	Activate Defaults	DEFALT	186

Genesis XP 7680GSR Scanner Product Specifications

Parameter	Specification
Mechanical	
Height	4.1 inches (105mm) / 5.7 inches (145mm) with stand
Length	3.2 inches (80mm)
Width	1.6 inches (40mm)
Weight	12 ounces (340g) with stand 7.1 ounces (200g) without stand
Electrical	
Voltage Requirements	5.0 VDC \pm 0.25V
Current Draw	400mA @ 5VDC, 2.0W
Illumination LED: Peak Wavelength	660nm \pm 10nm (Digimarc SKU only) (red LED) IEC 62471: "Exempt Risk Group" 2700K (white LED) IEC 62471: "Exempt Risk Group"
Aiming: Peak Wavelength LED	520nm \pm 18nm (green LED) IEC 62471: "Exempt Risk Group"
Environmental	
Temperature Ranges: Operating Storage	32°F to 122°F (0°C to 50°C) -40°F to 158°F (-40°C to 70°C)
Humidity	0 to 95% non-condensing
Mechanical Drop	Operational after 50 drops from 5 feet (1.5m) to concrete
ESD Tolerance	Up to \pm 15kV direct air Up to \pm 8 kV indirect coupling plane

Parameter (Continued)	Specification
Sealant Rating	IP52
Image	
Image Size	1280 x 800 pixels
Scan Performance	
Skew Angle	65°
Pitch Angle	65°
Motion Tolerance	Up to 400 cm/s (158 in/s) for 13 mil UPC at optimal focus
Symbol Contrast	20%

Depth of Field Charts

7680g Typical Performance

Focus		Standard Range	
Symbology		Near Distance	Far Distance
3 mil Cod 39	mm	0	98
	in.	0	3.9
5 mil Code 39	mm	0	151
	in.	0	6.0
6.7 mil PDF417	mm	0	138
	in.	0	5.4
10 mil Data Matrix	mm	0	129
	in.	0	5.1
13 mil UPC	mm	0	250
	in.	0	9.9
20 mil QR Code	mm	0	212
	in.	0	8.3
Resolution (1D)		3 mil (.076mm)	
Resolution (2D)		5 mil (.127mm)	

7680g Guaranteed Performance

Focus		Standard Range	
Symbology		Near Distance	Far Distance
3 mil Cod 39	mm	0	88
	in.	0	3.5
5 mil Code 39	mm	0	126
	in.	0	4.9
6.7 mil PDF417	mm	0	124
	in.	0	4.9
10 mil Data Matrix	mm	0	112
	in.	0	4.4
13 mil UPC	mm	0	210
	in.	0	8.3
20 mil QR Code	mm	0	175
	in.	0	6.9

Standard Connector Pinouts

Note: The following pin assignments are not compatible with some Honeywell legacy products. Use of a cable with improper pin assignments may lead to damage to the unit. Use of any cables not provided by the manufacturer may result in damage not covered by your warranty.

Keyboard Wedge

10 Pin RJ41 Modular Plug - connects to the base

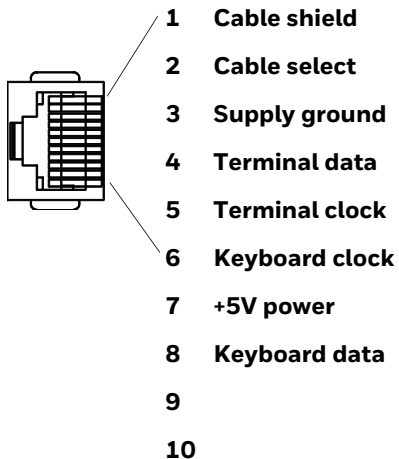

Serial Output

10 Pin RJ41 Modular Plug - connects to the base

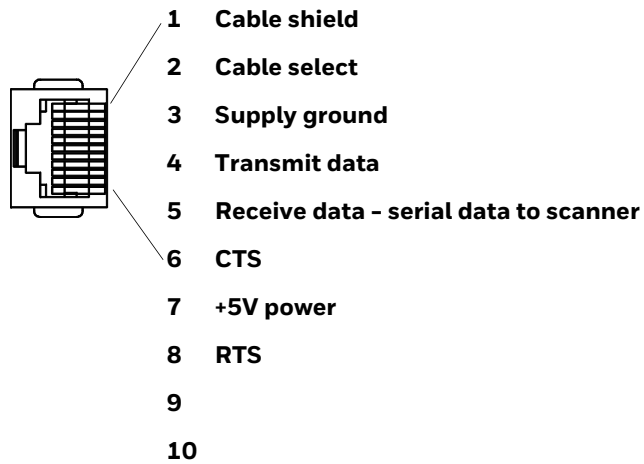

RS485 Output

10 Pin RJ41 Modular Plug - connects to the base

Note: RS485 signal conversion is performed in the cable.

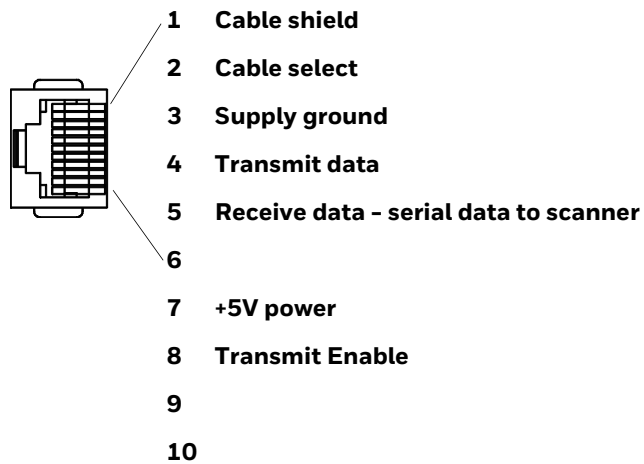

USB

10 Pin Modular Plug - connects to the base

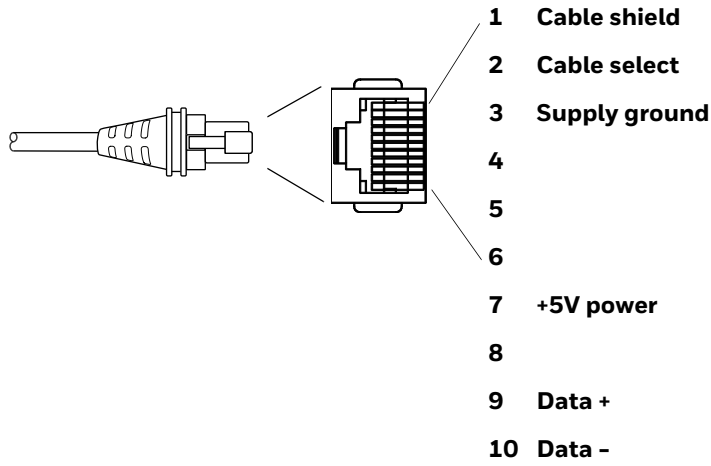

Required Safety Labels

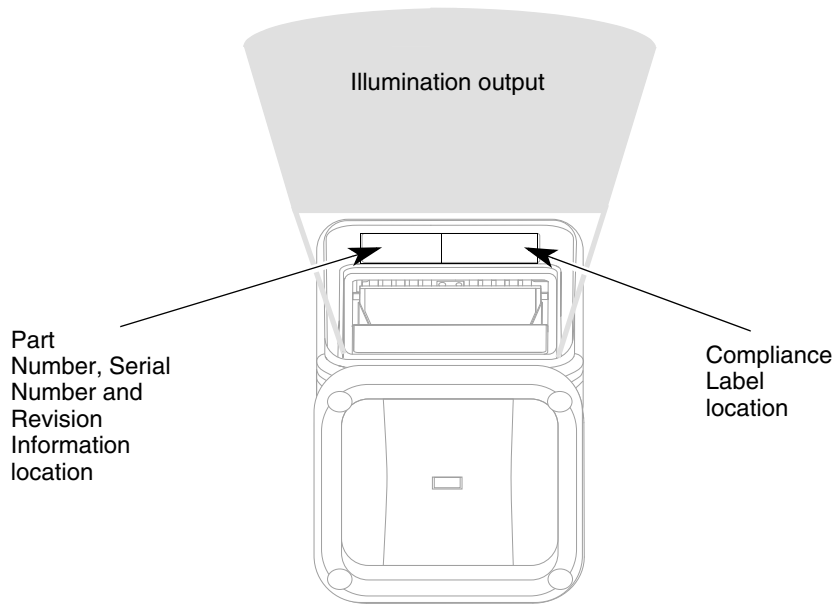

MAINTENANCE AND TROUBLESHOOTING

Repairs

Repairs and/or upgrades are not to be performed on this product. These services are to be performed only by an authorized service center (see [Customer Support](#) on page xiii).

Maintenance

Your device provides reliable and efficient operation with a minimum of care. Although specific maintenance is not required, the following sections describe periodic checks to ensure dependable operation.

Clean the Scanner

The scanner and scanner window may be cleaned with a soft cloth dampened with water or a mild detergent-water solution. If a mild detergent solution is used, wipe the scanner with a clean cloth dampened only with water to remove any detergent residue.

Note: *Reading performance may degrade if the scanner's window is not clean. If the window is visibly dirty, or if the scanner isn't operating well, clean the window.*



Caution: **Do not submerge the scanner in water or cleaning solution. Do not use abrasive wipes or cloths on the scanner's window. Abrasive wipes may scratch the window. Never use solvents (e.g., acetone) on the housing or window. Solvents may damage the finish or the window.**

Caution: **Ensure all components are dry prior to mating the scanner with charging accessories or other peripheral devices. Mating wet components may cause damage not covered by the warranty.**

About Disinfectant-ready Models

Genesis XP scanners have an external plastic housing that is designed to resist the effects of harsh chemicals. These scanners are equipped with disinfectant-ready housings (DRH) for the general-purpose market. Please refer to the General Purpose Disinfectant-Ready Housing Cleaning Guide located on your device's product page at sps.honeywell.com.

Inspect Cords and Connectors

Inspect the interface cable and connector for wear or other signs of damage. A badly worn cable or damaged connector may interfere with scanner operation. Contact your distributor for information about cable replacement. Cable replacement instructions are on [page 224](#).

Replace Cable

The standard interface cable is attached to the scanner with an 10-pin modular connector. When properly seated, the connector is held in the scanner's handle by a flexible retention tab. The interface cable is designed to be field replaceable.

- Order replacement cables from Honeywell or from an authorized distributor.
- When ordering a replacement cable, specify the cable part number of the original interface cable.

Replace an Interface Cable

1. Turn off the power to the host system.
2. Disconnect the scanner's cable from the terminal or computer.
3. Locate the small hole on the back of the scanner's handle. This is the cable release.
4. Straighten one end of a paper clip.
5. Insert the end of the paper clip into the small hole and press in. This depresses the retention tab, releasing the connector. Pull the connector out while maintaining pressure on the paper clip, then remove the paper clip.
6. Replace with the new cable.
Insert the connector into the opening and press firmly. The connector is keyed to go in only one way, and will click into place.

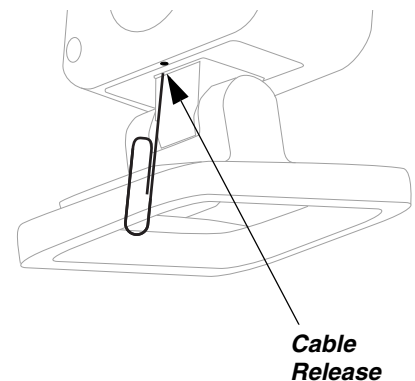

Troubleshoot

The scanner automatically performs self-tests whenever you turn it on. If your scanner is not functioning properly, review the following Troubleshooting Guide to try to isolate the problem.

Is the power on? Is the aimer on?

If the aimer isn't illuminated, check that:

- The cable is connected properly.
- The host system power is on (if external power isn't used).
- The trigger works.

Is the scanner having trouble reading your symbols?

If the scanner isn't reading symbols well, check that the symbols:

- Aren't smeared, rough, scratched, or exhibiting voids.
- Aren't coated with frost or water droplets on the surface.
- Are enabled in the scanner or in the decoder to which the scanner connects.

Is the barcode displayed but not entered?

The barcode is displayed on the host device correctly, but you still have to press a key to enter it (the Enter/Return key or the Tab key, for example).

- You need to program a suffix. Programming a suffix enables the scanner to output the barcode data plus the key you need (such as "CR") to enter the data into your application. Refer to [Prefix/Suffix Overview](#) on page 73 for further information.

If you aren't sure what programming options have been set in the scanner, or if you want the factory default settings restored, refer to [Reset the Factory Defaults](#) on page 186.

Symbology Charts

Note: “m” represents the AIM modifier character. Refer to *International Technical Specification, Symbology Identifiers*, for AIM modifier character details.

Prefix/Suffix entries for specific symbologies override the universal (*All Symbologies, 99*) entry.

Refer to [Data Edit](#) beginning on page 73 and [Data Format](#) beginning on page 79 for information about using Code ID and AIM ID.

Linear Symbologies

Linear Symbology	AIM		Honeywell	
	ID	Possible modifiers (m)	ID	Hex
<i>All Symbologies</i>				99
Codabar	JFm	0-1	a	61
Code 11	JH3		h	68
Code 128	JCm	0, 1, 2, 4	j	6A
Code 32 Pharmaceutical (PARAF)	JX0		<	3C
Code 39 (supports Full ASCII mode)	JAm	0, 1, 3, 4, 5, 7	b	62
TCIF Linked Code 39 (TLC39)	JL2		T	54
Code 93 and 93i	JGm	0-9, A-Z, a-m	i	69
EAN	JEm	0, 1, 3, 4	d	64
EAN-13 (including Bookland EAN)	JE0		d	64
EAN-13 with Add-On	JE3		d	64
EAN-13 with Extended Coupon Code	JE3		d	64
EAN-8	JE4		D	44

Linear Symbology	AIM		Honeywell	
	ID	Possible modifiers (m)	ID	Hex
EAN-8 with Add-On	JE3		D	44
GS1				
GS1 DataBar	jem	0	y	79
GS1 DataBar Limited	jem		{	7B
GS1 DataBar Expanded	jem		}	7D
GS1-128	JC1		l	49
2 of 5				
China Post (Hong Kong 2 of 5)	JX0		Q	51
Interleaved 2 of 5	Jlm	0, 1, 3	e	65
Matrix 2 of 5	JX0		m	6D
NEC 2 of 5	JX0		Y	59
Straight 2 of 5 IATA	JRm	0, 1, 3	f	66
Straight 2 of 5 Industrial	JS0		f	66
MSI	JMm	0, 1	g	67
Telepen	JBm		t	74
UPC		0, 1, 2, 3, 8, 9, A, B, C		
UPC-A	JE0		c	63
UPC-A with Add-On	JE3		c	63
UPC-A with Extended Coupon Code	JE3		c	63
UPC-E	JE0		E	45
UPC-E with Add-On	JE3		E	45
UPC-E1	JX0		E	45

Add Honeywell Code ID				5C80
Add AIM Code ID				5C81
Add Backslash				5C5C
Batch mode quantity			5	35

2D Symbologies

2D Symbology	AIM		Honeywell	
	ID	Possible modifiers (m)	ID	Hex
All Symbologies				99
Aztec Code]zm	0-9, A-C	z	7A

2D Symbology	AIM		Honeywell	
	ID	Possible modifiers (m)	ID	Hex
Chinese Sensible Code (Han Xin Code)]X0		H	48
Codablock A]06	0, 1, 4, 5, 6	V	56
Codablock F]0m	0, 1, 4, 5, 6	q	71
Code 49]Tm	0, 1, 2, 4	l	6C
Data Matrix]dm	0-6	w	77
Dot Code]J0		.	2E
GS1]em	0-3	y	79
GS1 Composite]em	0-3	y	79
GS1 DataBar Omnidirectional]em	0-3	y	79
MaxiCode]Um	0-3	x	78
PDF417]Lm	0-2	r	72
MicroPDF417]Lm	0-5	R	52
QR Code]Qm	0-6	s	73
Micro QR Code]Qm		s	73

Postal Symbologies

Postal Symbology	AIM		Honeywell	
	ID	Possible modifiers (m)	ID	Hex
All Symbologies				99
Australian Post]X0		A	41
British Post]X0		B	42
Canadian Post]X0		C	43
China Post]X0		Q	51
InfoMail]X0		,	2c
Intelligent Mail Barcode]X0		M	4D
Japanese Post]X0		J	4A
KIX (Netherlands) Post]X0		K	4B
Korea Post]X0		?	3F
Planet Code]X0		L	4C
Postal-4i]X0		N	4E
Postnet]X0		P	50

ASCII Conversion Chart (Code Page 1252)

In keyboard applications, ASCII Control Characters can be represented in 3 different ways, as shown below. The CTRL+X function is OS and application dependent. The following table lists some commonly used Microsoft functionality. This table applies to U.S. style keyboards. Certain characters may differ depending on your Country Code/PC regional settings.

Non-printable ASCII control characters			Keyboard Control + ASCII (CTRL+X) Mode		
DEC	HEX	Char	Control + X Mode Off (KBDCAS0)	Windows Mode Control + X Mode On (KBDCAS2)	
				CTRL + X	CTRL + X function
0	00	NUL	Reserved	CTRL+ @	
1	01	SOH	NP Enter	CTRL+ A	Select all
2	02	STX	Caps Lock	CTRL+ B	Bold
3	03	ETX	ALT Make	CTRL+ C	Copy
4	04	EOT	ALT Break	CTRL+ D	Bookmark
5	05	ENQ	CTRL Make	CTRL+ E	Center
6	06	ACK	CTRL Break	CTRL+ F	Find
7	07	BEL	Enter / Ret	CTRL+ G	
8	08	BS	<i>(Apple Make)</i>	CTRL+ H	History
9	09	HT	Tab	CTRL+ I	Italic
10	0A	LF	<i>(Apple Break)</i>	CTRL+ J	Justify
11	0B	VT	Tab	CTRL+ K	hyperlink
12	0C	FF	Delete	CTRL+ L	list, left align
13	0D	CR	Enter / Ret	CTRL+ M	
14	0E	SO	Insert	CTRL+ N	New
15	0F	SI	ESC	CTRL+ O	Open
16	10	DLE	F11	CTRL+ P	Print
17	11	DC1	Home	CTRL+ Q	Quit
18	12	DC2	PrtScn	CTRL+ R	
19	13	DC3	Backspace	CTRL+ S	Save
20	14	DC4	Back Tab	CTRL+ T	
21	15	NAK	F12	CTRL+ U	
22	16	SYN	F1	CTRL+ V	Paste
23	17	ETB	F2	CTRL+ W	
24	18	CAN	F3	CTRL+ X	
25	19	EM	F4	CTRL+ Y	
26	1A	SUB	F5	CTRL+ Z	
27	1B	ESC	F6	CTRL+ [
28	1C	FS	F7	CTRL+ \	
29	1D	GS	F8	CTRL+]	
30	1E	RS	F9	CTRL+ ^	
31	1F	US	F10	CTRL+ -	
127	7F	△	NP Enter		

Lower ASCII Reference Table

Note: Windows Code page 1252 and lower ASCII use the same characters.

Printable Characters								
DEC	HEX	Character	DEC	HEX	Character	DEC	HEX	Character
32	20	<SPACE>	64	40	@	96	60	`
33	21	!	65	41	A	97	61	a
34	22	"	66	42	B	98	62	b
35	23	#	67	43	C	99	63	c
36	24	\$	68	44	D	100	64	d
37	25	%	69	45	E	101	65	e
38	26	&	70	46	F	102	66	f
39	27	'	71	47	G	103	67	g
40	28	(72	48	H	104	68	h
41	29)	73	49	I	105	69	i
42	2A	*	74	4A	J	106	6A	j
43	2B	+	75	4B	K	107	6B	k
44	2C	,	76	4C	L	108	6C	l
45	2D	-	77	4D	M	109	6D	m
46	2E	.	78	4E	N	110	6E	n
47	2F	/	79	4F	O	111	6F	o
48	30	0	80	50	P	112	70	p
49	31	1	81	51	Q	113	71	q
50	32	2	82	52	R	114	72	r
51	33	3	83	53	S	115	73	s
52	34	4	84	54	T	116	74	t
53	35	5	85	55	U	117	75	u
54	36	6	86	56	V	118	76	v
55	37	7	87	57	W	119	77	w
56	38	8	88	58	X	120	78	x
57	39	9	89	59	Y	121	79	y
58	3A	:	90	5A	Z	122	7A	z
59	3B	;	91	5B	[123	7B	{
60	3C	<	92	5C	\	124	7C	
61	3D	=	93	5D]	125	7D	}
62	3E	>	94	5E	^	126	7E	~
63	3F	?	95	5F	_	127	7F	△

Extended ASCII Characters					
DEC	HEX	CP 1252	ASCII	Alternate Extended	PS2 Scan Code
128	80	€	Ç	up arrow ↑	0x48
129	81		ü	down arrow ↓	0x50
130	82	,	é	right arrow →	0x4B
131	83	f	â	left arrow ←	0x4D
132	84	„	ä	Insert	0x52
133	85	…	à	Delete	0x53
134	86	†	å	Home	0x47
135	87	‡	ç	End	0x4F
136	88	^	ê	Page Up	0x49
137	89	‰	ë	Page Down	0x51
138	8A	Š	è	Right ALT	0x38
139	8B	<	ï	Right CTRL	0x1D

Extended ASCII Characters (Continued)

DEC	HEX	CP 1252	ASCII	Alternate Extended	PS2 Scan Code
140	8C	Œ	î	Reserved	n/a
141	8D		ï	Reserved	n/a
142	8E	Ž	Ā	Numeric Keypad Enter	0x1C
143	8F		Ă	Numeric Keypad /	0x35
144	90		É	F1	0x3B
145	91	‘	æ	F2	0x3C
146	92	’	Æ	F3	0x3D
147	93	“	ô	F4	0x3E
148	94	”	ö	F5	0x3F
149	95	•	ò	F6	0x40
150	96	–	û	F7	0x41
151	97	—	ù	F8	0x42
152	98	˜	ÿ	F9	0x43
153	99	™	Ö	F10	0x44
154	9A	š	Ü	F11	0x57
155	9B	›	ç	F12	0x58
156	9C	œ	£	Numeric Keypad +	0x4E
157	9D		¥	Numeric Keypad -	0x4A
158	9E	ž	Ps	Numeric Keypad *	0x37
159	9F	ÿ	f	Caps Lock	0x3A
160	A0		á	Num Lock	0x45
161	A1	ı	í	Left Alt	0x38
162	A2	ç	ó	Left Ctrl	0x1D
163	A3	£	ú	Left Shift	0x2A
164	A4	¤	ñ	Right Shift	0x36
165	A5	¥	Ñ	Print Screen	n/a
166	A6	ı	ª	Tab	0x0F
167	A7	§	º	Shift Tab	0x8F
168	A8	¨	¿	Enter	0x1C
169	A9	©	ƒ	Esc	0x01
170	AA	ª	¬	Alt Make	0x36
171	AB	«	½	Alt Break	0xB6
172	AC	¬	¼	Control Make	0x1D
173	AD		ı	Control Break	0x9D
174	AE	®	«	Alt Sequence with 1 Character	0x36
175	AF	™	»	Ctrl Sequence with 1 Character	0x1D
176	B0	°	␣		
177	B1	±	␣		
178	B2	²	␣		
179	B3	³	␣		
180	B4	´	␣		
181	B5	µ	␣		
182	B6	¶	␣		
183	B7	·	␣		
184	B8	¸	␣		
185	B9	¹	␣		
186	BA	º	␣		
187	BB	»	␣		
188	BC	¼	␣		
189	BD	½	␣		
190	BE	¾	␣		
191	BF	¿	␣		
192	C0	À	␣		
193	C1	Á	␣		

Extended ASCII Characters (Continued)					
DEC	HEX	CP 1252	ASCII	Alternate Extended	PS2 Scan Code
194	C2	Â	Ɔ		
195	C3	Ã	Ɔ		
196	C4	Ä	—		
197	C5	Å	ı		
198	C6	Æ	Ɔ		
199	C7	Ç	Ɔ		
200	C8	È	Ɔ		
201	C9	É	Ɔ		
202	CA	Ê	Ɔ		
203	CB	Ë	Ɔ		
204	CC	Ì	Ɔ		
205	CD	Í	=		
206	CE	Î	Ɔ		
207	CF	Ï	Ɔ		
208	D0	Ð	Ɔ		
209	D1	Ñ	Ɔ		
210	D2	Ò	Ɔ		
211	D3	Ó	Ɔ		
212	D4	Ô	Ɔ		
213	D5	Õ	F		
214	D6	Ö	Ɔ		
215	D7	×	Ɔ		
216	D8	Ø	Ɔ		
217	D9	Ù	J		
218	DA	Ú	Ɔ		
219	DB	Û	■		
220	DC	Ü	■		
221	DD	Ý	■		
222	DE	Þ	■		
223	DF	ß	■		
224	E0	à	α		
225	E1	á	β		
226	E2	â	Γ		
227	E3	ã	π		
228	E4	ä	Σ		
229	E5	å	σ		
230	E6	æ	μ		
231	E7	ç	τ		
232	E8	è	Φ		
233	E9	é	Θ		
234	EA	ê	Ω		
235	EB	ë	δ		
236	EC	ì	∞		
237	ED	í	φ		
238	EE	î	ε		
239	EF	ï	∩		
240	F0	ð	≡		
241	F1	ñ	±		
242	F2	ò	≥		
243	F3	ó	≤		
244	F4	ô			
245	F5	õ]		
246	F6	ö	+		
247	F7	÷	≈		

Extended ASCII Characters (Continued)					
DEC	HEX	CP 1252	ASCII	Alternate Extended	PS2 Scan Code
248	F8	ø	°		
249	F9	ù	·		
250	FA	ú	·		
251	FB	û	√		
252	FC	ü	n		
253	FD	ý	²		
254	FE	þ	■		
255	FF	ÿ			

ISO 2022/ISO 646 Character Replacements

Code pages define the mapping of character codes to characters. If the data received does not display with the proper characters, it may be because the barcode being scanned was created using a code page that is different from the one the host program is expecting. If this is the case, select the code page with which the barcodes were created. The data characters should then appear properly.

Code Page Selection Method/ Country	Standard	Keyboard Country	Honeywell Code Page Option
United States (standard ASCII)	ISO/IEC 646-IRV	n/a	1
Automatic National Character Replacement	ISO/IEC 2022	n/a	2 (default)
Binary Code page	n/a	n/a	3
Default "Automatic National Character replacement" will select the below Honeywell Code Page options for Code128, Code 39 and Code 93.			
United States	ISO/IEC 646-06	0	1
Canada	ISO /IEC 646-121	54	95
Canada	ISO /IEC 646-122	18	96
Japan	ISO/IEC 646-14	28	98
China	ISO/IEC 646-57	92	99
Great Britain (UK)	ISO /IEC 646-04	7	87
France	ISO /IEC 646-69	3	83
Germany	ISO/IEC646-21	4	84
Switzerland	ISO /IEC 646-CH	6	86
Sweden / Finland (extended Annex C)	ISO/IEC 646-11	2	82
Ireland	ISO /IEC 646-207	73	97
Denmark	ISO/IEC 646-08	8	88
Norway	ISO/IEC 646-60	9	94
Italy	ISO/IEC 646-15	5	85
Portugal	ISO/IEC 646-16	13	92

Code Page Selection Method/ Country	Standard	Keyboard Country	Honeywell Code Page Option
Spain	ISO/IEC 646-17	10	90
Spain	ISO/IEC 646-85	51	91

Dec			35	36	64	91	92	93	94	96	123	124	125	126
Hex			23	24	40	5B	5C	5D	5E	60	7B	7C	7D	7E
US	0	1	#	\$	@	[\]	^	`	{		}	~
CA	54	95	#	\$	à	â	ç	ê	î	ô	é	ù	è	û
CA	18	96	#	\$	à	â	ç	ê	É	ô	é	ù	è	û
JP	28	98	#	\$	@	[¥]	^	`	{		}	-
CN	92	99	#	¥	@	[\]	^	`	{		}	-
GB	7	87	£	\$	@	[\]	^	`	{		}	~
FR	3	83	£	\$	à	°	ç	§	^	μ	é	ù	è	¨
DE	4	84	#	\$	§	Ä	Ö	Ü	^	`	ä	ö	ü	ß
CH	6	86	ù	\$	à	é	ç	ê	î	ô	ä	ö	ü	û
SE/FI	2	82	#	¤	É	Ä	Ö	Å	Ü	é	ä	ö	å	ü
DK	8	88	#	\$	@	Æ	Ø	Å	^	`	æ	ø	å	~
NO	9	94	#	\$	@	Æ	Ø	Å	^	`	æ	ø	å	-
IE	73	97	£	\$	Ó	É	Í	Ú	Á	ó	é	í	ú	á
IT	5	85	£	\$	§	°	ç	é	^	ù	à	ò	è	ì
PT	13	92	#	\$	§	Ã	Ç	Õ	^	`	ã	ç	õ	°
ES	10	90	#	\$	§	í	Ñ	¿	^	`	°	ñ	ç	~
ES	51	91	#	\$	·	í	Ñ	Ç	¿	`	´	ñ	ç	¨
COUNTRY	Country Keyboard	Honeywell CodePage	ISO / IEC 646 National Character Replacements											

Keyboard Key References

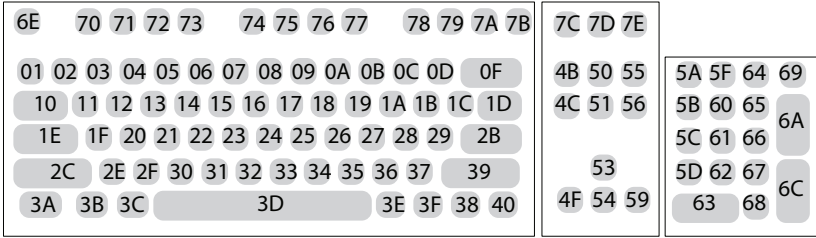

104 Key U.S. Style Keyboard

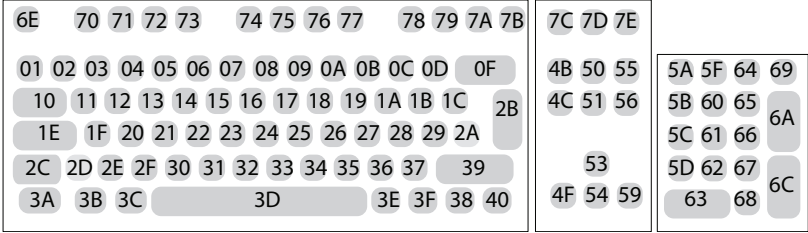

105 Key European Style Keyboard

SAMPLE SYMBOLS

UPC-A



0 123456 7890

Interleaved 2 of 5



01234567890

EAN-13

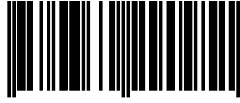

9 780330 290951

Code 128

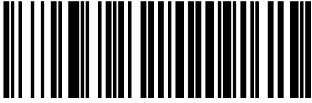

Code 128

Code 39

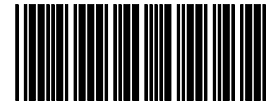

BC321

Codabar

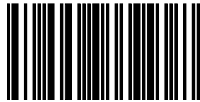

A13579B

Code 93

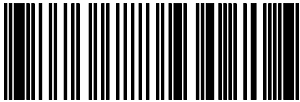

123456-9\$

Straight 2 of 5 Industrial

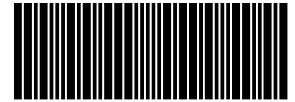

123456

Matrix 2 of 5



6543210

RSS-14



(01) 00123456789012

PDF417



Car Registration

Code 49

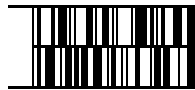

1234567890

SAMPLE SYMBOLS (CONTINUED)

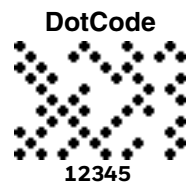
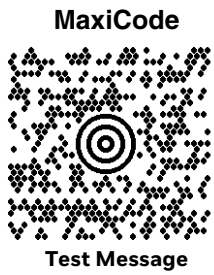

PROGRAMMING CHART



K0K
0



K2K
2



K4K
4



K6K
6



K8K
8



K1K
1



K3K
3



K5K
5



K7K
7



K9K
9

PROGRAMMING CHART (CONTINUED)



KAK
A



KBK
B



KCK
C



KDK
D



KEK
E



KFK
F



MNUSAV.
Save



MNUABT.
Discard



RESET_
Reset

Note: If you make an error while scanning the letters or digits (before scanning **Save**), scan **Discard**, scan the correct letters or digits, and **Save** again.

Honeywell
855 S. Mint Street
Charlotte, NC 28202

sps.honeywell.com