

Honeywell

Vuquest™ 3320g

Area-Imaging Scanner

User Guide

Disclaimer

Honeywell International Inc. (“HII”) reserves the right to make changes in specifications and other information contained in this document without prior notice, and the reader should in all cases consult HII to determine whether any such changes have been made. HII makes no representation or warranties regarding the information provided in this publication.

HII shall not be liable for technical or editorial errors or omissions contained herein; nor for incidental or consequential damages resulting from the furnishing, performance, or use of this material. HII disclaims all responsibility for the selection and use of software and/or hardware to achieve intended results.

This document contains proprietary information that is protected by copyright. All rights are reserved. No part of this document may be photocopied, reproduced, or translated into another language without the prior written consent of HII.

Copyright © 2023 Honeywell Group of Companies. All rights reserved.

Web Address: sps.honeywell.com

Other product names or marks mentioned in this document may be trademarks or registered trademarks of other companies and are the property of their respective owners.

For patent information, refer to www.hsmpats.com.

TABLE OF CONTENTS

Customer Support	xiii
Technical Assistance	xiii
Product Service and Repair	xiii
Limited Warranty	xiii
Chapter 1 - Getting Started.....	1
About This Manual.....	1
Unpacking Your Device.....	1
Connecting the Device.....	2
Connecting with USB.....	2
Connecting with Keyboard Wedge.....	3
Connecting with RS232 Serial Port.....	4
Reading Techniques.....	5
Menu Barcode Security Settings	5
Setting Custom Defaults.....	5
Resetting the Custom Defaults	6
About Software Revisions	6
Chapter 2 - Programming the Interface.....	7
Introduction.....	7
Programming the Interface - Plug and Play	7
Keyboard Wedge	7
Laptop Direct Connect	8
RS232 Serial Port.....	8
USB IBM SurePos	8

USB PC or Macintosh Keyboard.....	9
USB HID	9
USB Serial.....	10
Remote MasterMind™ for USB	10
Verifone® Ruby Terminal Default Settings.....	11
Gilbarco® Terminal Default Settings	11
Honeywell Bioptic Aux Port Configuration	12
Datalogic™ Magellan© Aux Port Configuration	12
NCR Bioptic Aux Port Configuration	12
Wincor Nixdorf Terminal Default Settings	13
Wincor Nixdorf Beetle™ Terminal Default Settings	13
Keyboard Country Layout.....	14
Keyboard Style	21
Keyboard Conversion	22
Control Character Output.....	23
Keyboard Modifiers.....	23
RS232 Modifiers	25
RS232 Baud Rate	25
RS232 Word Length: Data Bits, Stop Bits, and Parity	27
RS232 Receiver Time-Out	28
RS232 Handshaking.....	28
RS232 Timeout.....	29
XON/XOFF.....	29
ACK/NAK	29
Scanner to Bioptic Communication.....	30
Scanner-Bioptic Packet Mode	30
Scanner-Bioptic ACK/NAK Mode	30
Scanner-Bioptic ACK/NAK Timeout.....	31

Chapter 3 - Input/Output Settings..... 33

Power Up Beeper.....	33
Beep on BEL Character	33
Trigger Click	34

Good Read and Error Indicators.....	34
Beeper – Good Read	34
Beeper Volume – Good Read	34
Beeper Pitch – Good Read	35
Beeper Pitch – Error	35
Beeper Duration – Good Read.....	36
LED – Good Read.....	36
Number of Beeps – Good Read	36
Number of Beeps – Error	36
Good Read Delay.....	37
User-Specified Good Read Delay	37
Manual Trigger Modes	37
LED Illumination - Manual Trigger.....	38
Serial Trigger Mode	39
Read Time-Out.....	40
Presentation Mode	40
LED Illumination - Presentation Mode.....	41
Presentation LED Behavior after Decode.....	41
Presentation Sensitivity	42
Presentation Centering	42
CodeGate®	44
Streaming Presentation™ Mode.....	44
Mobile Phone Read Mode	45
Hands-Free Time-Out	45
Character Activation Mode.....	46
Activation Character.....	46
Character Activation Laser Timeout	46
Character Deactivation Mode	47
End Character Activation After Good Read	47
Character Activation Timeout.....	47
Deactivation Character	48
Reread Delay	48
User-Specified Reread Delay.....	48

2D Reread Delay.....	49
Illumination Lights.....	49
Aimer Delay.....	50
User-Specified Aimer Delay.....	50
Aimer Mode.....	50
Centering.....	51
Preferred Symbology.....	52
High Priority Symbology.....	53
Low Priority Symbology.....	53
Preferred Symbology Time-out.....	54
Preferred Symbology Default.....	54
Output Sequence Overview.....	54
Output Sequence Editor.....	54
To Add an Output Sequence.....	54
Other Programming Selections.....	55
Output Sequence Example.....	55
Output Sequence Editor.....	57
Partial Sequence.....	57
Require Output Sequence.....	57
Multiple Symbols.....	58
No Read.....	58
Video Reverse.....	59
Working Orientation.....	60

Chapter 4 - Data Editing 61

Prefix/Suffix Overview.....	61
Points to Keep In Mind.....	61
To Add a Prefix or Suffix:.....	62
Example: Add a Tab Suffix to All Symbologies.....	62
To Clear One or All Prefixes or Suffixes.....	62
To Add a Carriage Return Suffix to All Symbologies.....	63
Prefix Selections.....	64
Suffix Selections.....	64

Function Code Transmit.....	64
Intercharacter, Interfunction, and Intermessage Delays	65
Intercharacter Delay.....	65
User Specified Intercharacter Delay.....	65
Interfunction Delay.....	66
Intermessage Delay	66

Chapter 5 - Data Formatting.....67

Data Format Editor Introduction	67
Add a Data Format.....	68
Other Programming Selections	69
Terminal ID Table.....	70
Data Format Editor Commands	70
Send Commands	70
Move Commands.....	75
Search Commands.....	77
Miscellaneous Commands	79
Data Formatter.....	83
Data Format Non-Match Error Tone.....	84
Primary/Alternate Data Formats	85
Single Scan Data Format Change.....	85

Chapter 6 - External Input / Output87

External Input.....	87
External Trigger Control.....	87
External Trigger Polarity	88
External Trigger Parameters	88
External Trigger Schematic	89
External Output	89
External Illumination Control.....	89
External Illumination Parameters.....	90
External Illumination Schematic.....	91

Chapter 7 - Symbologies..... 93

- All Symbologies 94
- Message Length Description..... 94
- Codabar 95
 - Codabar On/Off..... 95
 - Codabar Start/Stop Characters..... 95
 - Codabar Check Character..... 95
 - Codabar Concatenation 96
 - Codabar Message Length 97
- Code 39..... 97
 - Code 39 On/Off 97
 - Code 39 Start/Stop Characters 97
 - Code 39 Check Character 98
 - Code 39 Message Length..... 98
 - Code 39 Append 99
 - Code 32 Pharmaceutical (PARAF)..... 99
 - Full ASCII 100
 - Code 39 Code Page 101
- Interleaved 2 of 5 101
 - Interleaved 2 of 5 On/Off..... 101
 - Check Digit..... 101
 - Interleaved 2 of 5 Message Length 102
- NEC 2 of 5..... 103
 - NEC 2 of 5 On/Off..... 103
 - Check Digit..... 103
 - NEC 2 of 5 Message Length..... 104
- Code 93..... 104
 - Code 93 On/Off 104
 - Code 93 Message Length..... 104
 - Code 93 Append 105
 - Code 93 Code Page 105
- Straight 2 of 5 Industrial (three-bar start/stop)..... 106
 - Straight 2 of 5 Industrial On/Off 106

Straight 2 of 5 Industrial Message Length	106
Straight 2 of 5 IATA (two-bar start/stop)	107
Straight 2 of 5 IATA On/Off.....	107
Straight 2 of 5 IATA Message Length	107
Matrix 2 of 5	108
Matrix 2 of 5 On/Off.....	108
Matrix 2 of 5 Message Length.....	108
Code 11	109
Code 11 On/Off.....	109
Check Digits Required	109
Code 11 Message Length	109
Code 128	110
Code 128 On/Off.....	110
ISBT 128 Concatenation.....	110
Code 128 Message Length.....	110
Code 128 Append	111
Code 128 Code Page.....	111
GS1-128	112
GS1-128 On/Off.....	112
GS1-128 Message Length.....	112
Telepen	113
Telepen On/Off.....	113
Telepen Output	113
Telepen Message Length	113
UPC-A	114
UPC-A On/Off	114
UPC-A Check Digit	114
UPC-A Number System.....	115
UPC-A Addenda.....	115
UPC-A Addenda Required.....	115
UPC-A Addenda Separator	116
UPC-A/EAN-13 with Extended Coupon Code	116
Coupon GS1 DataBar Output.....	117

UPC-E0	117
UPC-E0 On/Off.....	117
UPC-E0 Expand.....	117
UPC-E0 Addenda Required.....	118
UPC-E0 Addenda Separator	118
UPC-E0 Check Digit.....	118
UPC-E0 Leading Zero.....	119
UPC-E0 Addenda	119
UPC-E1	119
EAN/JAN-13	120
EAN/JAN-13 On/Off.....	120
Convert UPC-A to EAN-13.....	120
EAN/JAN-13 Check Digit	120
EAN/JAN-13 Addenda	121
EAN/JAN-13 Addenda Required.....	121
EAN/JAN-13 Addenda Separator	121
ISBN Translate.....	122
EAN/JAN-8	122
EAN/JAN-8 On/Off.....	122
EAN/JAN-8 Check Digit.....	123
EAN/JAN-8 Addenda	123
EAN/JAN-8 Addenda Required.....	123
EAN/JAN-8 Addenda Separator	124
MSI.....	124
MSI On/Off	124
MSI Check Character.....	124
MSI Message Length.....	125
GS1 DataBar Omnidirectional.....	126
GS1 DataBar Omnidirectional On/Off	126
GS1 DataBar Limited	126
GS1 DataBar Limited On/Off.....	126
GS1 DataBar Expanded	126
GS1 DataBar Expanded On/Off	127
GS1 DataBar Expanded Message Length.....	127

Trioptic Code	127
Codablock A.....	128
Codablock A On/Off	128
Codablock A Message Length.....	128
Codablock F.....	129
Codablock F On/Off	129
Codablock F Message Length.....	129
PDF417	130
PDF417 On/Off.....	130
PDF417 Message Length	130
MacroPDF417	130
MicroPDF417	131
MicroPDF417 On/Off.....	131
MicroPDF417 Message Length.....	131
GS1 Composite Codes	131
UPC/EAN Version.....	132
GS1 Composite Code Message Length.....	132
GS1 Emulation.....	132
TCIF Linked Code 39 (TLC39).....	133
QR Code	134
QR Code On/Off.....	134
QR Code Message Length	134
QR Code Append.....	134
QR Code Page	135
Data Matrix	135
Data Matrix On/Off.....	135
Data Matrix Message Length	136
Data Matrix Code Page.....	136
MaxiCode.....	137
MaxiCode On/Off	137
MaxiCode Message Length.....	137
Aztec Code	138
Aztec Code On/Off	138

Aztec Code Message Length	138
Aztec Append	138
Aztec Code Page	139
Chinese Sensible (Han Xin) Code	139
Han Xin Code On/Off	139
Han Xin Code Message Length	139
Postal Codes - 2D	140
Single 2D Postal Codes:.....	141
Combination 2D Postal Codes:.....	143
Planet Code Check Digit.....	145
Postnet Check Digit.....	145
Australian Post Interpretation.....	145
Postal Codes - Linear	146
China Post (Hong Kong 2 of 5)	146
China Post (Hong Kong 2 of 5) On/Off	146
China Post (Hong Kong 2 of 5) Message Length	147
Korea Post	147
Korea Post Message Length	147

Chapter 8 - Imaging Commands149

Single-Use Basis	149
Command Syntax	149
Image Snap - IMGSNP.....	150
IMGSNP Modifiers	150
Image Ship - IMGSHIP	153
IMGSHIP Modifiers	154
Image Size Compatibility	162
Intelligent Signature Capture - IMGBOX	162
Signature Capture Optimize.....	163
IMGBOX Modifiers.....	164

Chapter 9 - Utilities.....169

To Add a Test Code I.D. Prefix to All Symbologies	169
---	-----

Show Decoder Revision	169
Show Scan Driver Revision.....	170
Show Software Revision	170
Show Data Format	170
Test Menu.....	170
TotalFreedom.....	171
Application Plug-Ins (Apps).....	171
EZConfig for Scanning Introduction	172
Configure with EZConfig for Scanning.....	172
Resetting the Factory Defaults	173

Chapter 10 - Serial Programming Commands..... 175

Conventions	175
Menu Command Syntax.....	175
Query Commands	176
Trigger Commands.....	178
Resetting the Custom Defaults	179
Menu Commands	180
Product Default Settings	180
Programming the Interface.....	180
Input/Output Selections	184
Prefix/Suffix Selections	188
Data Formatter Selections	188
External Input/Output.....	189
Symbologies	189
Postal Codes - 2D.....	196
Postal Codes - Linear.....	197
Imaging Default Commands.....	198
Utilities.....	200

Chapter 11 - Product Specifications..... 201

3320 Scanner Product Specifications.....	201
Depth of Field	202

Typical Performance	202
Guaranteed Performance	202
Mounting General Guidelines	203
Standard Cable Pinouts	204
Keyboard Wedge	204
Serial Output	205
USB	205
Scanner	206

Chapter 12 - Maintenance and Troubleshooting207

Repairs	207
Maintenance.....	207
Cleaning the Scanner.....	207
Cleaning the Window.....	207
Inspecting Cords and Connectors.....	208
Replacing Cables	208
Replacing an Interface Cable.....	209
Troubleshooting a Corded Scanner.....	209

Appendix A - Reference Charts.....211

Symbology Charts	211
Linear Symbologies.....	211
2D Symbologies.....	212
Postal Symbologies	213
ASCII Conversion Chart (Code Page 1252).....	214
Lower ASCII Reference Table	215
ISO 2022/ISO 646 Character Replacements.....	218
Keyboard Key References	220
Sample Symbols.....	220
Programming Chart.....	222

Customer Support

Technical Assistance

To search our knowledge base for a solution or to log in to the Technical Support portal and report a problem, go to honeywell.com/PSStechnicalsupport.

For our latest contact information, see honeywell.com/PSSlocations.

Product Service and Repair

Honeywell International Inc. provides service for all of its products through service centers throughout the world. Go to sps.honeywell.com and select **Support** > **Productivity** to find a service center near you or to get a Return Material Authorization number (RMA #) before returning a product.

Limited Warranty

For warranty information, go to sps.honeywell.com and select **Support** > **Productivity** > **Warranties**.

GETTING STARTED

About This Manual

This User's Guide provides installation and programming instructions for the Vuquest™ 3320 area-imaging scanner. Product specifications, dimensions, warranty, and customer support information are also included.

Honeywell barcode scanners are factory programmed for the most common terminal and communications settings. If you need to change these settings, programming is accomplished by scanning the barcodes in this guide.

An asterisk (*) next to an option indicates the default setting.

Note: *This User Guide includes commands and defaults that are affected by the software revision on your scanner. For more information about determining the software revision on your scanner, see [About Software Revisions](#) on page 6.*

Unpacking Your Device

After you open the shipping carton containing the product, take the following steps:

- Check for damage during shipment. Report damage immediately to the carrier who delivered the carton.
- Make sure the items in the carton match your order.
- Save the shipping container for later storage or shipping.

Connecting the Device

Connecting with USB

A scanner can be connected to the USB port of a computer.

1. Connect the appropriate interface cable to the device first, then to the computer.

Scanner USB Connection:

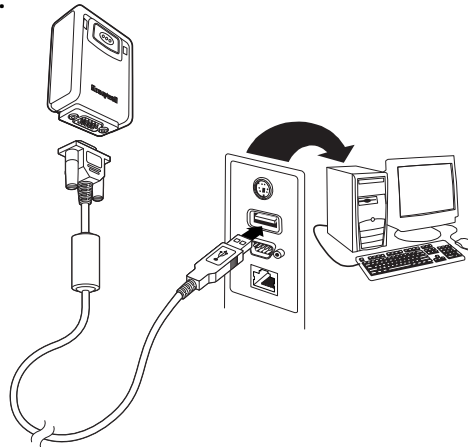

2. The scanner beeps.
3. Verify the scanner operation by scanning a barcode from the [Sample Symbols](#), beginning on page 220.

The unit defaults to a USB PC Keyboard. Refer to [page 9](#) for other USB terminal settings.

For additional USB programming and technical information, refer to “USB Application Note,” available at sps.honeywell.com.

Connecting with Keyboard Wedge

A scanner can be connected between the keyboard and PC as a “keyboard wedge,” where the scanner provides data output that is similar to keyboard entries. The following is an example of a keyboard wedge connection:

1. Turn Off power and disconnect the keyboard cable from the back of the terminal/computer.
2. Connect the appropriate interface cable to the device and to the terminal/computer.

**Scanner
Keyboard Wedge
Connection:**

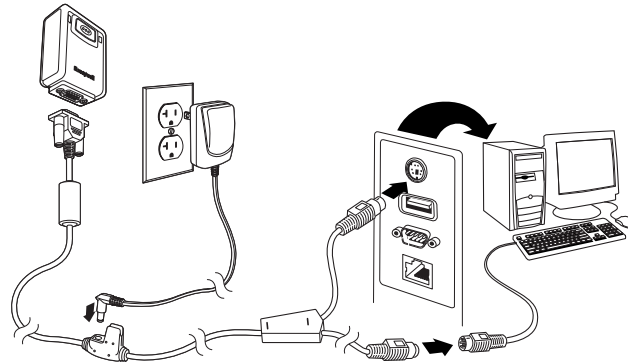

3. Turn the terminal/computer power back On. The scanner beeps.
4. Verify the scanner operation by scanning a barcode from the [Sample Symbols](#), beginning on page 220. The scanner beeps once.

The unit defaults to an IBM PC AT and compatibles keyboard wedge interface with a USA keyboard. A carriage return (CR) suffix is added to barcode data.

Connecting with RS232 Serial Port

1. Turn Off power to the terminal/computer.
2. Connect the appropriate interface cable to the scanner.

Note: For the scanner to work properly, you must have the correct cable for your type of terminal/computer.

Scanner RS232 Serial Port Connection:

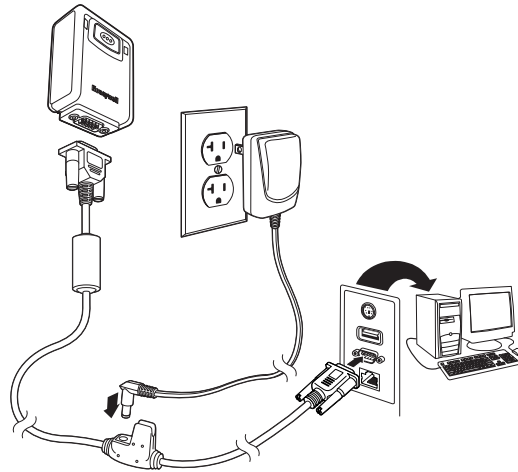

3. Plug the serial connector into the serial port on your computer. Tighten the two screws to secure the connector to the port.
4. Once the scanner has been fully connected, power up the computer.

This interface programs 115,200 baud, 8 data bits, no parity, and 1 stop bit.

Note: Please note, the end of the cable with the ferrite plugs into the scanner. The end of the cable with the label "DO NOT connect this end to the barcode scanner" plugs into the computer.

Reading Techniques

The scanner has a view finder that projects a bright green aiming beam that corresponds to the scanner's horizontal field of view. The aiming beam should be centered over the barcode, but it can be positioned in any direction for a good read.

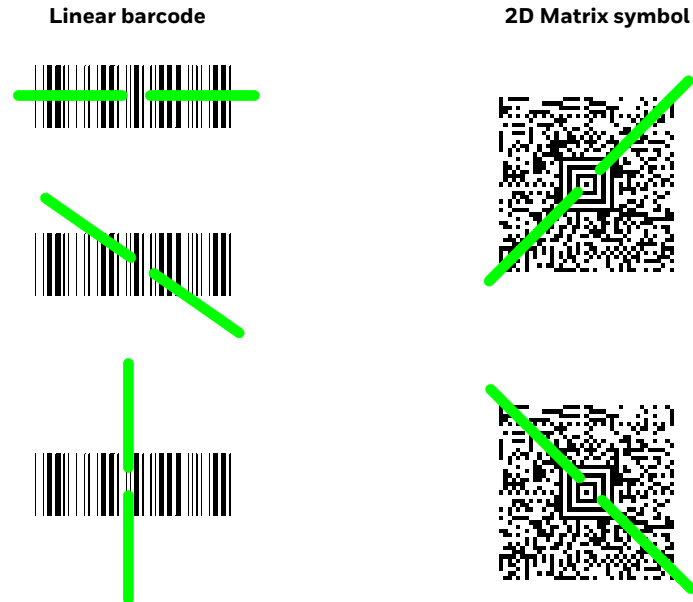

The aiming beam is smaller when the scanner is closer to the code and larger when it is farther from the code. Symbologies with smaller bars or elements (mil size) should be read closer to the unit. Symbologies with larger bars or elements (mil size) should be read farther from the unit. To read single or multiple symbols (on a page or on an object), hold the scanner at an appropriate distance from the target, push the button, and center the aiming beam on the symbol. If the code being scanned is highly reflective (e.g., laminated), it may be necessary to tilt the code up 15° to 18° to prevent unwanted reflection.

Menu Barcode Security Settings

Honeywell scanners are programmed by scanning menu barcodes or by sending serial commands to the scanner. If you want to restrict the ability to scan menu codes, you can use the Menu Barcode Security settings. Please contact the nearest technical support office (see [Technical Assistance](#) on page xiii) for further information.

Setting Custom Defaults

You have the ability to create a set of menu commands as your own, custom defaults. To do so, scan the Set Custom Defaults barcode below before scanning the menu commands for your custom defaults. If a menu command requires

scanning numeric codes from the [Programming Chart](#), beginning on page 222, and then a Save code, that entire sequence will be saved to your custom defaults. When you have entered all the commands you want to save for your custom defaults, scan the Set Custom Defaults barcode.



MNUCDF.

Set Custom Defaults



MNUCDS.

Save Custom Defaults

You may have a series of custom settings and want to correct a single setting. To do so, just scan the new setting to overwrite the old one. For example, if you had previously saved the setting for Beeper Volume at Low to your custom defaults, and decide you want the beeper volume set to High, just scan the Set Custom Defaults barcode, then scan the Beeper Volume High menu code, and then scan Save Custom Defaults. The rest of the custom defaults will remain, but the beeper volume setting will be updated.

Resetting the Custom Defaults

If you want the custom default settings restored to your scanner, scan the Activate Custom Defaults barcode below. This is the recommended default barcode for most users. It resets the scanner to the custom default settings. If there are no custom defaults, it will reset the scanner to the factory default settings. Any settings that have not been specified through the custom defaults will be defaulted to the factory default settings.



DEFAULT.

Activate Custom Defaults

About Software Revisions

This User Guide includes commands and defaults that are affected by the software revision on your scanner. The revisions are referred to as Gen 6 and Gen 7.

To determine the software revision on your scanner, use the Show Software Revision barcode (REVINF command) on [page 170](#).

The response for this command includes a Software Part Number field that displays the software revision in the following formats:

- Gen 6 uses the format BYxxxxxxBAA
- Gen 7 uses the format GNxxxxxxBAA

Introduction

This chapter describes how to program your system for the desired interface.

Programming the Interface - Plug and Play

Plug and Play barcodes provide instant scanner set up for commonly used interfaces.

Note: After you scan one of the codes, power cycle the host terminal to have the interface in effect.

Keyboard Wedge

If you want your system programmed for an IBM PC AT and compatibles keyboard wedge interface with a USA keyboard, scan the barcode below. Keyboard wedge is the default interface.

Note: The following barcode also programs a carriage return (CR) suffix.



PAP_AT.

IBM PC AT and Compatibles with
CR suffix

Laptop Direct Connect

For most laptops, scanning the Laptop Direct Connect barcode allows operation of the scanner in parallel with the integral keyboard. The following Laptop Direct Connect barcode also programs a carriage return (CR) suffix and turns on Emulate External Keyboard (see [page 22](#)).



RS232 Serial Port

The RS232 Interface barcode is used when connecting to the serial port of a PC or terminal. The following RS232 Interface barcode also programs a carriage return (CR) and a line feed (LF) suffix, baud rate, and data format as indicated below. It also changes the trigger mode to manual.

Option	Setting
Baud Rate	115,200 bps
Data Format	8 data bits, no parity bit, 1 stop bit



USB IBM SurePos

Scan one of the following “Plug and Play” codes to program the scanner for an IBM SurePos (USB handheld scanner) or IBM SurePos (USB tabletop scanner) interface.

Note: After scanning one of these codes, you must power cycle the cash register.



Each barcode above also programs the following suffixes for each symbology:

Symbology	Suffix	Symbology	Suffix
EAN 8	0C	Code 39	00 0A 0B
EAN 13	16	Interleaved 2 of 5	00 0D 0B
UPC A	0D	Code 128	00 18 0B
UPC E	0A	Code 39	00 0A 0B

USB PC or Macintosh Keyboard

Scan one of the following codes to program the scanner for USB PC Keyboard or USB Macintosh Keyboard. Scanning these codes also adds a CR and LF.



PAF124.

USB Keyboard (PC)



PAF125.

USB Keyboard (Mac)



TRMUSB134.

USB Japanese Keyboard (PC)

USB HID

Scan the following code to program the scanner for USB HID barcode scanners.



PAF131.

USB HID Barcode Scanner

USB Serial

Scan the following code to program the scanner to emulate a regular RS232-based COM Port. If you are using a Microsoft® Windows® PC, you will need to download a driver from the Honeywell website (sps.honeywell.com). The driver will use the next available COM Port number. Apple® Macintosh computers recognize the scanner as a USB CDC class device and automatically use a class driver.



Note: No extra configuration (e.g., baud rate) is necessary.

CTS/RTS Emulation



ACK/NAK Mode



Remote MasterMind™ for USB

When using a USB interface, you may wish to configure your scanner to communicate with Remote MasterMind Scanner Management Software (ReM). Scan the ReM On barcode to communicate with ReM. To disable this capability, scan ReM Off. *Default = ReM On.*





REMIFC1.
* ReM On

Verifone[®] Ruby Terminal Default Settings

Scan the following Plug and Play code to program the scanner for a Verifone Ruby terminal. This barcode sets the baud rate to 1200 bps and the data format to 8 data bits, Mark parity bit, 1 stop bit. It also adds a line feed (LF) suffix and programs the following prefixes for each symbology:

Symbology	Prefix
UPC-A	A
UPC-E	A
EAN-8	FF
EAN-13	F



PAPRBY.

Verifone Ruby Settings

Note: If you are having unexpected results with this programming code, scan the Activate Defaults barcode on [page 6](#) first, then scan the programming code above.

Gilbarco[®] Terminal Default Settings

Scan the following Plug and Play code to program the scanner for a Gilbarco terminal. This barcode sets the baud rate to 2400 bps and the data format to 7 data bits, even parity, 2 stop bits. It also adds a carriage return (CR) suffix and programs the following prefixes for each symbology:

Symbology	Prefix
UPC-A	A
UPC-E	EO
EAN-8	FF
EAN-13	F



PAPGLB.

Gilbarco Settings

Note: If you are having unexpected results with this programming code, scan the Activate Defaults barcode on [page 6](#) first, then scan the programming code above.

Honeywell Bioptic Aux Port Configuration

Scan the following Plug and Play code to program the scanner for a Honeywell bioptic scanner auxiliary port configuration. This barcode sets the baud rate to 38400 bps and the data format to 8 data bits, no parity, 1 stop bit.



Note: If you are having unexpected results with this programming code, scan the Activate Defaults barcode on [page 6](#) first, then scan the programming code above.

Datalogic™ Magellan® Aux Port Configuration

Scan the following Plug and Play code to program the scanner for a Datalogic Magellan auxiliary port configuration. This barcode sets the baud rate to 9600 bps and the data format to 8 data bits, no parity, 1 stop bit.



Note: If you are having unexpected results with this programming code, scan the Activate Defaults barcode on [page 6](#) first, then scan the programming code above.

NCR Bioptic Aux Port Configuration

Scan the following Plug and Play code to program the scanner for an NCR bioptic scanner auxiliary port configuration. The communication should be set at 9600bps baud rate, 7 data bit data format, even parity, and 1 stop bit. The following prefixes are programmed for each symbology:

Symbology	Prefix	Symbology	Prefix
UPC-A	A	Interleaved 2 of 5	b
UPC-E	E0	Code 128	f
		GS1 DataBar Omnidirectional	r
EAN-8	FF	GS1 DataBar Expanded	r
EAN-13	F	Codabar	N
Code 39	a	Code 32 Pharmaceutical (PARAF)	a



PAPNCR.

NCR Bioptic Settings

Note: If you are having unexpected results with this programming code, scan the Activate Defaults barcode on [page 6](#) first, then scan the programming code above.

Wincor Nixdorf Terminal Default Settings

Scan the following Plug and Play code to program the scanner for a Wincor Nixdorf terminal. This barcode sets the baud rate to 9600 bps and the data format to 8 data bits, no parity, 1 stop bit.



PAPWNX.

Wincor Nixdorf Terminal Settings

Note: If you are having unexpected results with this programming code, scan the Activate Defaults barcode on [page 6](#) first, then scan the programming code above.

Wincor Nixdorf Beetle™ Terminal Default Settings

Scan the following Plug and Play code to program the scanner for a Wincor Nixdorf Beetle terminal. The following prefixes are programmed for each symbology:

Symbology	Prefix	Symbology	Prefix
Aztec Code	V	Interleaved 2 of 5	I
Codabar	N	MaxiCode	T
Code 93	L	MicroPDF417	S
Code 128	K	PDF417	Q
Data Matrix	R	QR Code	U
EAN-8	B	Straight 2 of 5 IATA	H
EAN-13	A	UPC-A	A0
GS1 DataBar	E	UPC-E	C
GS1-128	P	All other barcodes	M



PAPBTL.

Wincor Nixdorf Beetle Settings

Note: If you are having unexpected results with this programming code, scan the Activate Defaults barcode on [page 6](#) first, then scan the programming code above.

Keyboard Country Layout

If your interface is USB Keyboard or Keyboard Wedge, your keyboard layout default is a US keyboard. To change this layout, refer to the chart below for your keyboard country. Scan the appropriate barcode below to change the layout.

By default, national character replacements are used for the following characters: # \$ @ [\] ^ { | } ~ See the [Symbology Charts](#), beginning on page 211, to view the character replacements for each country. ,

Keyboard Countries



KBDCTY0.
*** United States**



KBDCTY35.
Albania



KBDCTY81.
Azeri (Cyrillic)



KBDCTY80.
Azeri (Latin)



KBDCTY82.
Belarus



KBDCTY1.
Belgium



KBDCTY33.
Bosnia



KBDCTY16.
Brazil



KBDCTY59.
Brazil (MS)

Keyboard Countries (Continued)



KBDCTY53.
Bulgaria (Latin)



KBDCTY18.
Canada (French)



KBDCTY32.
Croatia



KBDCTY40.
Czech (Programmers)



KBDCTY38.
Czech (QWERTZ)



KBDCTY11.
Dutch (Netherlands)



KBDCTY52.
Bulgaria (Cyrillic)



KBDCTY54.
Canada (French legacy)



KBDCTY55.
Canada (Multilingual)



KBDCTY15.
Czech



KBDCTY39.
Czech (QWERTY)



KBDCTY8.
Denmark

Keyboard Countries (Continued)



KBDCTY83.
Faroese



KBDCTY3.
France



KBDCTY4.
Germany



KBDCTY64.
Greek (220 Latin)



KBDCTY65.
Greek (319 Latin)



KBDCTY63.
Greek (Latin)



KBDCTY41.
Estonia



KBDCTY2.
Finland



KBDCTY84.
Gaelic



KBDCTY17.
Greek



KBDCTY61.
Greek (220)



KBDCTY62.
Greek (319)

Keyboard Countries (Continued)



KBDCTY60.
Greek (Polytonic)



KBDCTY50.
Hungarian (101 key)



KBDCTY75.
Iceland



KBDCTY56.
Italian (142)



KBDCTY28.
Japan ASCII



KBDCTY79.
Kyrgyz (Cyrillic)



KBDCTY66.
Greek (MS)



KBDCTY12.
Hebrew



KBDCTY19.
Hungary



KBDCTY73.
Irish



KBDCTY5.
Italy



KBDCTY78.
Kazakh

Keyboard Countries (Continued)



KBDCTY42.
Latvia



KBDCTY44.
Lithuania



KBDCTY34.
Macedonia



KBDCTY86.
Mongolian (Cyrillic)



KBDCTY20.
Poland



KBDCTY58.
Polish (Programmers)



KBDCTY14.
Latin America



KBDCTY43.
Latvia (QWERTY)



KBDCTY45.
Lithuania (IBM)



KBDCTY74.
Malta



KBDCTY9.
Norway



KBDCTY57.
Polish (214)

Keyboard Countries (Continued)



KBDCTY25.
Romania



KBDCTY67.
Russian (MS)



KBDCTY21.
SCS



KBDCTY36.
Serbia (Latin)



KBDCTY49.
Slovakia (QWERTY)



KBDCTY31.
Slovenia



KBDCTY13.
Portugal



KBDCTY26.
Russia



KBDCTY68.
Russian (Typewriter)



KBDCTY37.
Serbia (Cyrillic)



KBDCTY22.
Slovakia



KBDCTY48.
Slovakia (QWERTZ)

Keyboard Countries (Continued)



KBDCTY51.
Spanish variation



KBDCTY29.
Switzerland (French)



KBDCTY85.
Tatar



KBDCTY24.
Turkey Q



KBDCTY7.
United Kingdom



KBDCTY88.
United States (Dvorak left)



KBDCTY10.
Spain



KBDCTY23.
Sweden



KBDCTY6.
Switzerland (German)



KBDCTY27.
Turkey F



KBDCTY76.
Ukrainian



KBDCTY87.
United States (Dvorak)

Keyboard Countries (Continued)



KBDCTY30.

United States (International)



KBDCTY89.

United States (Dvorak)



KBDCTY77.

Uzbek (Cyrillic)

Keyboard Style

This programs keyboard styles, such as Caps Lock and Shift Lock. If you have used [Keyboard Conversion](#) settings, they will override any of the following Keyboard Style settings. *Default = Regular.*

Regular is used when you normally have the Caps Lock key Off.



KBDSTY0.

*** Regular**

Caps Lock is used when you normally have the Caps Lock key On.



KBDSTY1.

Caps Lock

Shift Lock is used when you normally have the Shift Lock key On (not common to U.S. keyboards).



KBDSTY2.

Shift Lock

Automatic Caps Lock is used if you change the Caps Lock key On and Off. The software tracks and reflects if you have Caps Lock On or Off. This selection can only be used with systems that have an LED that notes the Caps Lock status (AT keyboards).



KBDSTY6.

Automatic Caps Lock

Autocaps via NumLock barcode should be scanned in countries (e.g., Germany, France) where the Caps Lock key cannot be used to toggle Caps Lock. The NumLock option works similarly to the regular Autocaps, but uses the NumLock key to retrieve the current state of the Caps Lock.



KBDSTY7.

Autocaps via NumLock

Emulate External Keyboard should be scanned if you do not have an external keyboard (IBM AT or equivalent).



KBDSTY5.

Emulate External Keyboard

Note: After scanning the Emulate External Keyboard barcode, you must power cycle your computer.

Keyboard Conversion

Alphabetic keyboard characters can be forced to be all upper case or all lower case. So if you have the following barcode: “abc569GK,” you can make the output “ABC569GK” by scanning Convert All Characters to Upper Case, or to “abc569gk” by scanning Convert All Characters to Lower Case.

These settings override [Keyboard Style](#) selections.

Note: If your interface is a keyboard wedge, first scan the menu code for [Automatic Caps Lock](#) on page 21. Otherwise, your output may not be as expected.

Default = Keyboard Conversion Off.



KBDCNV0.

*** Keyboard Conversion Off**



KBDCNV1.

**Convert All Characters
to Upper Case**



KBDCNV2.

**Convert All Characters
to Lower Case**

Control Character Output

This selection sends a text string instead of a control character. For example, when the control character for a carriage return is expected, the output would display [CR] instead of the ASCII code of 0D. Refer to [ASCII Conversion Chart \(Code Page 1252\)](#) on page 214. Only codes 00 through 1F are converted (the first column of the chart).

Note: *Control + X (Control + ASCII) Mode overrides this mode.*

Default = Off.



KBDNPE1.

Control Character Output On



KBDNPE0.

*** Control Character Output Off**

Keyboard Modifiers

This modifies special keyboard features, such as CTRL+ ASCII codes and Turbo Mode.

Control + X (Control + ASCII) Mode On

The scanner sends key combinations for ASCII control characters for values 00-1F. Windows is the preferred mode. All keyboard country codes are supported. DOS mode is a legacy mode, and it does not support all keyboard country codes. New users should use the Windows mode. Refer to [ASCII Conversion Chart \(Code Page 1252\)](#) on page 214 for CTRL+ X Values.

Windows Mode Prefix/Suffix Off: The scanner sends key combinations for ASCII control characters for values 00-1F, but it does not translate any prefix or suffix information.

Default = Control + X Mode Off.



KBDCAS2.

**Windows Mode Control + X
Mode On**



KBDCAS0.

*** Control + X Mode Off**



KBDCAS1.

DOS Mode Control + X Mode On



KBDCAS3.

Windows Mode Prefix/Suffix

Turbo Mode: The scanner sends characters to a terminal faster. If the terminal drops characters, do not use Turbo Mode. *Default = Off.*



KBDTMD1.

Turbo Mode On



KBDTMD0.

*** Turbo Mode Off**

Numeric Keypad Mode: Sends numeric characters as if entered from a numeric keypad. *Default = Off.*



KBDNPS1.

Numeric Keypad Mode On



KBDNPS0.

*** Numeric Keypad Mode Off**

Automatic Direct Connect Mode: This selection can be used if you have an IBM AT style terminal and the system is dropping characters. *Default = Off.*



KBDADC1.

**Automatic Direct Connect
Mode On**



KBDADC0.

*** Automatic Direct Connect
Mode Off**

RS232 Modifiers

RS232 Baud Rate

Baud Rate sends the data from the scanner to the terminal at the specified rate. The host terminal must be set for the same baud rate as the scanner. *Default = 115,200.*





232BAD0.

300



232BAD2.

1200



232BAD4.

4800



232BAD6.

19200



232BAD8.

57,600



232BAD9.

*** 115,200**



232BAD1.

600



232BAD3.

2400



232BAD5.

9600



232BAD7.

38400



232BAD9.

*** 115,200**

RS232 Word Length: Data Bits, Stop Bits, and Parity

Data Bits sets the word length at 7 or 8 bits of data per character. If an application requires only ASCII Hex characters 0 through 7F decimal (text, digits, and punctuation), select 7 data bits. For applications that require use of the full ASCII set, select 8 data bits per character. *Default = 8.*

Stop Bits sets the stop bits at 1 or 2. *Default = 1.*

Parity provides a means of checking character bit patterns for validity. *Default = None.*



232WRD3.

7 Data, 1 Stop, Parity Even



232WRD0.

7 Data, 1 Stop, Parity None



232WRD6.

7 Data, 1 Stop, Parity Odd



232WRD4.

7 Data, 2 Stop, Parity Even



232WRD1.

7 Data, 2 Stop Parity None



232WRD7.

7 Data, 2 Stop, Parity Odd



232WRD5.

8 Data, 1 Stop, Parity Even



232WRD2.

*** 8 Data, 1 Stop, Parity None**



232WRD8.

8 Data, 1 Stop, Parity Odd



232WRD14.

8 Data, 1 Stop, Parity Mark

RS232 Receiver Time-Out

The unit stays awake to receive data until the RS232 Receiver Time-Out expires. A manual or serial trigger resets the time-out. When an RS232 receiver is sleeping, a character may be sent to wake up the receiver and reset the time-out. A transaction on the CTS line will also wake up the receiver. The receiver takes 300 milliseconds to completely come up. Change the RS232 receiver time-out by scanning the barcode below, then scanning digits from the [Programming Chart](#), beginning on page 222, then scanning **Save**. The range is 0 to 300 seconds. *Default = 0 seconds (no time-out - always on).*



232LPT.

RS232 Receiver Time-Out

RS232 Handshaking

RS232 Handshaking allows control of data transmission from the scanner using software commands from the host device. When RTS/CTS is turned Off, no data flow control is used.

Flow Control, No Timeout: The scanner asserts RTS when it has data to send, and will wait indefinitely for CTS to be asserted by the host.

Two-Direction Flow Control: The scanner asserts RTS when it is OK for the host to transmit. The host asserts CTS when it is OK for the device to transmit.

Flow Control with Timeout: The scanner asserts RTS when it has data to send and waits for a delay (see [RS232 Timeout](#) on page 29) for CTS to be asserted by the host. If the delay time expires and CTS is not asserted, the device transmit buffer is cleared and scanning may resume.

Default = RTS/CTS Off.



232CTS1.

Flow Control, No Timeout



232CTS2.

Two-Direction Flow Control



232CTS3.

Flow Control with Timeout



232CTS0.

* RTS/CTS Off

RS232 Timeout

When using Flow Control with Timeout, you must program the length of the delay you want to wait for CTS from the host. Set the length (in milliseconds) for a timeout by scanning the barcode below, then setting the timeout (from 1-5100 milliseconds) by scanning digits from the [Programming Chart](#), beginning on page 222, then scanning **Save**.



232DEL.

RS232 Timeout

XON/XOFF

Standard ASCII control characters can be used to tell the scanner to start sending data (XON/XOFF On) or to stop sending data (XON/XOFF Off). When the host sends the XOFF character (DC3, hex 13) to the scanner, data transmission stops. To resume transmission, the host sends the XON character (DC1, hex 11). Data transmission continues where it left off when XOFF was sent. *Default = XON/XOFF Off.*



232XON1.

XON/XOFF On



232XOND.

* XON/XOFF Off

ACK/NAK

After transmitting data, the scanner waits for an ACK character (hex 06) or a NAK character (hex 15) response from the host. If ACK is received, the communications cycle is completed and the scanner looks for more barcodes. If NAK is received, the

last set of barcode data is retransmitted and the scanner waits for ACK/NAK again. Turn On the ACK/NAK protocol by scanning the ACK/NAK On barcode below. To turn Off the protocol, scan ACK/NAK Off. *Default = ACK/NAK Off.*



Scanner to Bioptic Communication

The following settings are used to set up communication between Honeywell scanners and bioptic scanners.

Note: *The scanner's baud rate must be set to 38400 and the RS232 timeout must be set to 3000 in order to communicate with a bioptic scanner. See [RS232 Modifiers](#) on page 25 and [RS232 Timeout](#) on page 29 for further information.*

Scanner-Bioptic Packet Mode

Packet Mode On must be scanned to set the scanner's format so it is compatible with a bioptic scanner. *Default = Packet Mode Off.*



Scanner-Bioptic ACK/NAK Mode

Bioptic ACK/NAK On must be scanned so the scanner will wait for an ACK or NAK from a bioptic scanner after each packet is sent. The Scanner-Bioptic ACK/NAK Timeout (below) controls how long the scanner will wait for a response. *Default = Bioptic ACK/NAK Off.*





232NAK1.
Bioptic ACK/NAK On

Scanner-Bioptic ACK/NAK Timeout

This allows you to set the length (in milliseconds) for a timeout for a bioptic scanner's ACK/NAK response. Scan the barcode below, then set the timeout (from 1-30,000 milliseconds) by scanning digits from the [Programming Chart](#), beginning on page 222, then scanning **Save**. *Default = 5100.*



232DLK.
ACK/NAK Timeout

Power Up Beeper

The scanner can be programmed to beep when it's powered up. Scan the Off barcode(s) if you don't want a power up beep. *Default = Power Up Beeper On - Scanner.*



BEPPWR0.

**Power Up Beeper Off -
Scanner**



BEPPWR1.

*** Power Up Beeper On -
Scanner**

Beep on BEL Character

You may wish to force the scanner to beep upon a command sent from the host. If you scan the Beep on BEL On barcode below, the scanner will beep every time a BEL character is received from the host. *Default = Beep on BEL Off.*



BELBEP0.

***Beep on BEL Off**



BELBEP1.

Beep on BEL On

Trigger Click

To hear an audible click every time the scanner button is pushed, scan the Trigger Click On barcode below. Scan the Trigger Click Off code if you don't wish to hear the click. (This feature has no effect on serial or automatic triggering.) *Default = Trigger Click Off.*



BEPTRG0.
***Trigger Click Off**



BEPTRG1.
Trigger Click On

Good Read and Error Indicators

Beeper – Good Read

The beeper may be programmed On or Off in response to a good read. Turning this option Off only turns Off the beeper response to a good read indication. All error and menu beeps are still audible. *Default = Beeper - Good Read On.*



BEPBEP0.
Beeper - Good Read Off



BEPBEP1.
*** Beeper - Good Read On**

Beeper Volume – Good Read

The beeper volume codes modify the volume of the beep the scanner emits on a good read. *Default = High.*



BEPLVL1.
Low



BEPLVL2.
Medium



BEPLVL3.
* High



BEPLVL0.
Off

Beeper Pitch – Good Read

The beeper pitch codes modify the pitch (frequency) of the beep the scanner emits on a good read. *Default = Medium.*



BEPFQ11600.
Low (1600 Hz)



BEPFQ12700.
* Medium (2700 Hz)



BEPFQ14200.
High (4200 Hz)

Beeper Pitch – Error

The beeper pitch codes modify the pitch (frequency) of the sound the scanner emits when there is a bad read or error. *Default = Razz.*



BEPFQ2250.
* Razz (250 Hz)



BEPFQ23250.
Medium (3250 Hz)



BEPFQ24200.
High (4200 Hz)

Beeper Duration – Good Read

The beeper duration codes modify the length of the beep the scanner emits on a good read. *Default = Normal.*



BEPBIP0.

* Normal Beep



BEPBIP1.

Short Beep

LED – Good Read

The LED indicator can be programmed On or Off in response to a good read. *Default = On.*



BEPLED1.

* LED - Good Read On



BEPLED0.

LED - Good Read Off

Number of Beeps – Good Read

The number of beeps of a good read can be programmed from 1 - 9. The same number of beeps will be applied to the beeper and LED in response to a good read. For example, if you program this option to have five beeps, there will be five beeps and five LED flashes in response to a good read. The beeps and LED flashes are in sync with one another. To change the number of beeps, scan the barcode below and then scan a digit (1-9) barcode and the **Save** barcode from the [Programming Chart](#), beginning on page 222. *Default = 1.*



BEPRPT.

Number of Good Read Beeps/LED Flashes

Number of Beeps – Error

The number of beeps and LED flashes emitted by the scanner for a bad read or error can be programmed from 1 - 9. For example, if you program this option to have five error beeps, there will be five error beeps and five LED flashes in response

to an error. To change the number of error beeps, scan the barcode below and then scan a digit (1-9) barcode and the **Save** barcode from the [Programming Chart](#), beginning on page 222. *Default = 1.*



Good Read Delay

This sets the minimum amount of time before the scanner can read another barcode. *Default = 0 ms (No Delay).*



User-Specified Good Read Delay

If you want to set your own length for the good read delay, scan the barcode below, then set the delay (from 0 - 30,000 milliseconds) by scanning digits from the [Programming Chart](#), beginning on page 222, then scanning **Save**.



Manual Trigger Modes

When in manual trigger mode, the scanner scans until a barcode is read, or until the button is released. Two modes are available, Normal and Enhanced. Normal mode offers good scan speed and the longest working ranges (depth of field). Enhanced mode will give you the highest possible scan speed but slightly less

range than Normal mode. Enhanced mode is best used when you require a very fast scan speed and don't require a long working range. *Default = Manual Trigger - Normal.*



PAPHHF.

* Manual Trigger - Normal



PAPHHS.

Manual Trigger -

LED Illumination - Manual Trigger

If you want to set the LED illumination brightness, scan one of the barcodes below. This sets the LED illumination for the scanner when the button is pushed. *Default = High.*

Note: *The LEDs are like a flash on a camera. The lower the ambient light in the room, the brighter the LEDs need to be so the scanner can “see” the barcodes.*

Note: *For scanners with the Gen 7 software revision, this setting applies to both Manual Mode and Presentation Mode.*

For Manual Mode with Gen 7, you must first scan the Set Exposure Mode - Manual Trigger Mode barcode before setting the LED illumination brightness. See [LED Illumination Exposure Mode - Manual Trigger](#) on page 39.

For Presentation Mode with Gen 7, you must first use the Set Exposure Mode - Presentation Mode barcode before setting the LED illumination brightness. See [LED Illumination Exposure Mode - Presentation Mode](#) on page 39.

For information about software revisions, see [About Software Revisions](#) on page 6.



PWRNOLD.

Off



PWRNOL100.

Low



PWRNOL150.

* High

LED Illumination Exposure Mode - Manual Trigger

For scanners with the Gen 7 software revision that are using Manual Trigger Mode, you must first scan the Set Exposure Mode - Manual Trigger Mode barcode before scanning one of the [LED Illumination - Manual Trigger](#) barcodes.

Default = Automatic Exposure - Manual Trigger Mode.

Note: For information about software revisions, see [About Software Revisions](#) on page 6.



* Automatic Exposure - Manual Trigger Mode



Set Exposure Mode - Manual Trigger Mode

LED Illumination Exposure Mode - Presentation Mode

For scanners with the Gen 7 software revision that are using Presentation Mode, you must first scan the Set Exposure Mode - Presentation Mode barcode before scanning one of the [LED Illumination - Manual Trigger](#) barcodes.

Default = Automatic Exposure - Presentation Mode.

Note: For information about software revisions, see [About Software Revisions](#) on page 6.



* Automatic Exposure - Presentation Mode



Set Exposure Mode - Presentation Mode

Serial Trigger Mode

You can activate the scanner either by pushing the button, or using a serial trigger command (see [Trigger Commands](#) on page 178). When in serial mode, the scanner scans until a barcode has been read or until the deactivate command is sent. The scanner can also be set to turn itself Off after a specified time has elapsed (see [Read Time-Out](#), which follows).

Read Time-Out

Use this selection to set a time-out (in milliseconds) of the scanner's button when using serial commands to trigger the scanner. Once the scanner has timed out, you can activate the scanner either by pushing the button or using a serial trigger command. After scanning the Read Time-Out barcode, set the time-out duration (from 0-300,000 milliseconds) by scanning digits from the [Programming Chart](#), beginning on page 222, then scanning **Save**. *Default = 30,000 ms.*



Presentation Mode

Presentation Mode uses ambient light and scanner illumination to detect barcodes. When in Presentation Mode, the LEDs remain dim until a barcode is presented to the scanner, then the aimer turns On and the LEDs turn up to read the code. If the light level in the room is not high enough, Presentation Mode may not work properly.

Scan the following barcode to program your scanner for Presentation Mode.



LED Illumination - Presentation Mode

If you wish to set the LED illumination brightness, scan one of the barcodes below. This sets the LED illumination for the scanner when it is in Presentation Mode. If the scanner is triggered manually, the LED illumination will switch to the setting for a manual trigger. (See [LED Illumination - Manual Trigger](#) on page 38.)
Default = High.

Note: This command is not supported by the Gen 7 software revision. For scanners with the Gen 7 revision, use [LED Illumination - Manual Trigger](#) on page 38 for both Presentation Mode and Manual Mode. For information about software revisions, see [About Software Revisions](#) on page 6.

Note: The LEDs are like a flash on a camera. The lower the ambient light in the room, the brighter the LEDs need to be so the scanner can “see” the barcodes.



Note: LED Illumination - Presentation Mode does not apply to [Streaming Presentation™ Mode](#) or [Mobile Phone Read Mode](#).

Presentation LED Behavior after Decode

When a scanner is in presentation mode, the LEDs dim 30 seconds after a barcode is decoded. If you wish to dim the LEDs immediately after a barcode is decoded, scan the LEDs Off barcode, below. *Default = LEDs On.*



Presentation Sensitivity

Presentation Sensitivity is a numeric range that increases or decreases the scanner's reaction time to barcode presentation. To set the sensitivity, scan the Sensitivity barcode, then scan the degree of sensitivity (from 0-20) from the [Programming Chart](#), beginning on page 222, and **Save**. 0 is the most sensitive setting, and 20 is the least sensitive. *Default = 1.*

Note: *This command is not supported with the Gen 7 software revision. For information about software revisions, see [About Software Revisions](#) on page 6.*



Presentation Centering

Use Presentation Centering to narrow the scanner's field of view when it is in Presentation Mode to make sure the scanner reads only those barcodes intended by the user. For instance, if multiple codes are placed closely together, Presentation Centering will insure that only the desired codes are read.

Note: *To adjust centering when the scanner is hand-held, see [Centering](#) on page 51.*

If a barcode is not touched by a predefined window, it will not be decoded or output by the scanner. If Presentation Centering is turned On by scanning Presentation Centering On, the scanner only reads codes that pass through the centering window you specify using the Top of Presentation Centering Window, Bottom of Presentation Centering Window, Left, and Right of Presentation Centering Window barcodes.

In the example below, the white box is the centering window. The centering window has been set to 20% left, 30% right, 8% top, and 25% bottom. Since Barcode 1 passes through the centering window, it will be read. Barcode 2 does not pass through the centering window, so it will not be read.

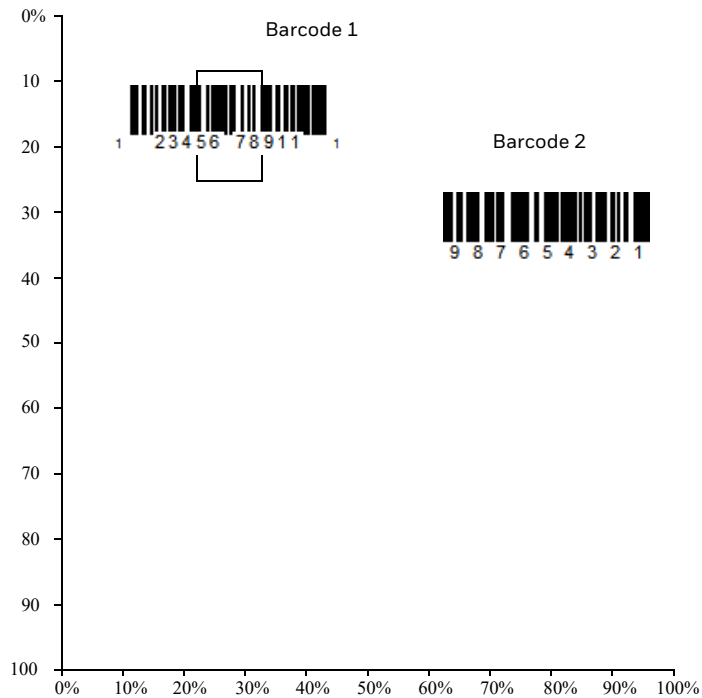

Note: A barcode needs only to be touched by the centering window in order to be read. It does not need to pass completely through the centering window.

Scan Presentation Centering On, then scan one of the following barcodes to change the top, bottom, left, or right of the centering window. Then scan the percent you want to shift the centering window using digits from the [Programming Chart](#), beginning on page 222, and then scan **Save**. Default Presentation Centering = 40% for Top and Left, 60% for Bottom and Right.





PDCLFT.
**Left of
 Presentation Centering
 Window**



PDCBOT.
**Bottom of Presentation
 Centering Window**



PDCRGT.
**Right of Presentation
 Centering Window**

CodeGate[®]

When CodeGate is On, the button is used to allow decoded data to be transmitted to the host system. The scanner remains On, scanning and decoding barcodes, but the barcode data is not transmitted until the button is pushed. When CodeGate is Off, barcode data is transmitted when it is decoded. *Default = CodeGate Off Out-of-Stand.*



AOSCGDO.
*** CodeGate Off
 Out-of-Stand**



AOSCGD1.
**CodeGate On
 Out-of-Stand**

Streaming Presentation™ Mode

When in Streaming Presentation mode, the scanner's aimer goes out after a short time, but the scan illumination remains On all the time to continuously search for barcodes. Two modes are available, Normal and Enhanced. Normal mode offers good scan speed and the longest working ranges (depth of field). Enhanced mode will give you the highest possible scan speed but slightly less range than Normal mode. Enhanced mode is best used when you require a very fast scan speed and don't require a long working range.



PAPS PN.
**Streaming Presentation
 Mode - Normal**



When using [Preferred Symbology](#) on page 52, a lower priority symbol must be centered on the aiming pattern to be read in Streaming Presentation Mode.

Mobile Phone Read Mode

When this mode is selected, your scanner is optimized to read barcodes from mobile phone or other LED displays. However, the speed of scanning printed barcodes may be slightly lower when this mode is enabled. You can enable Mobile Phone Reading for either a hand held device, or for a hands-free (presentation) application.



Note: To turn Off Mobile Phone Read Mode, scan a Manual or Serial Trigger Mode barcode (see page [37](#)).

Hands-Free Time-Out

The Presentation Mode is referred to as “hands-free” mode. If the scanner’s button is pushed when using a hands-free mode, the scanner changes to manual trigger mode. You can set the time the scanner should remain in manual trigger mode by setting the Hands-Free Time-Out. Once the time-out value is reached, (if there have been no further button pushes) the scanner reverts to the original hands-free mode.

Scan the Hands-Free Time-Out barcode, then scan the time-out duration (from 0-300,000 milliseconds) from the [Programming Chart](#), beginning on page 222, and then scan **Save**. *Default = 5,000 ms.*



Character Activation Mode

You may use a character sent from the host to trigger the scanner to begin scanning. When the activation character is received, the scanner continues scanning until either the [Character Activation Laser Timeout](#) on page 46, the deactivation character is received (see [Deactivation Character](#) on page 48), or a barcode is transmitted. Scan the following On barcode to use character activation, then use Activation Character (following) to select the character you will send from the host to start scanning. *Default = Off.*



Activation Character

This sets the character used to trigger scanning when using Character Activation Mode. On the [ASCII Conversion Chart \(Code Page 1252\)](#) on page 214, find the hex value that represents the character you want to use to trigger scanning. Scan the following barcode, then use the [Programming Chart](#), beginning on page 222, to read the alphanumeric combination that represents that ASCII character. Scan **Save** to finish.



Character Activation Laser Timeout

You can set a timeout for the length of time the laser remains On and attempting to decode barcodes when using Character Activation Mode. Set the length (in milliseconds) for a timeout by scanning the following barcode, then setting the timeout (from 1-65535 milliseconds) by scanning digits from the [Programming Chart](#), beginning on page 222, then scanning **Save**. *Default = 5000 ms.*



Character Deactivation Mode

If you have sent a character from the host to trigger the scanner to begin scanning, you can also send a deactivation character to stop scanning. Scan the following On barcode to use character deactivation, then use Deactivation Character (following) to select the character you will send from the host to terminate scanning. *Default = Off.*



End Character Activation After Good Read

After a barcode is successfully detected and read from the scanner, the illumination can be programmed either to remain On and scanning, or to turn Off. When End Character Activation After Good Read is enabled, the illumination turns Off and stops scanning after a good read. If you scan Do Not End Character Activation After Good Read, the illumination remains On after a good read. *Default = End Character Activation After Good Read.*



Character Activation Timeout

You can set a timeout for the length of time the illumination remains On and attempting to decode barcodes when using Character Activation Mode. Set the length (in milliseconds) for a timeout by scanning the following barcode, then setting the timeout (from 1-300,000 milliseconds) by scanning digits from the [Programming Chart](#), beginning on page 222, then scanning **Save**. *Default = 30,000 ms.*



Deactivation Character

This sets the character used to terminate scanning when using Character Deactivation Mode. On the [ASCII Conversion Chart \(Code Page 1252\)](#) on page 214, find the hex value that represents the character you want to use to terminate scanning. Scan the following barcode, then use the [Programming Chart](#), beginning on page 222, to read the alphanumeric combination that represents that ASCII character. Scan **Save** to finish.



Reread Delay

This sets the time period before the scanner can read the *same* barcode a second time. Setting a reread delay protects against accidental rereads of the same barcode. Longer delays are effective in minimizing accidental rereads. Use shorter delays in applications where repetitive barcode scanning is required. Reread Delay only works when in a [Presentation Mode](#) (see page 40). *Default = Medium.*



User-Specified Reread Delay

If you want to set your own length for the reread delay, scan the barcode below, then set the delay (from 0-65,535 milliseconds) by scanning digits from the [Programming Chart](#), beginning on page 222, then scanning **Save**.



2D Reread Delay

Sometimes 2D barcodes can take longer to read than other barcodes. If you wish to set a separate Reread Delay for 2D barcodes, scan one of the programming codes that follows. 2D Reread Delay Off indicates that the time set for [Reread Delay](#) is used for both 1D and 2D barcodes. *Default = 2D Reread Delay Off.*



DLY2RR0.

* 2D Reread Delay Off



DLY2RR1000.

Short (1000ms)



DLY2RR2000.

Medium (2000ms)



DLY2RR3000.

Long (3000ms)



DLY2RR4000.

Extra Long (4000ms)

Illumination Lights

If you want the illumination lights On while reading a barcode, scan the Lights On barcode, below. However, if you want to turn just the lights Off, scan the Lights Off barcode. *Default = Lights On.*

Note: *This setting does not affect the aimer light. The aiming light can be set using [Aimer Mode](#) (see page 50).*



SCNLED1.

* Lights On



SCNLED0.

Lights Off

Aimer Delay

The aimer delay allows a delay time for the operator to aim the scanner before the picture is taken. Use these codes to set the time between when the button is pushed and when the picture is taken. During the delay time, the aiming light will appear, but the LEDs won't turn On until the delay time is over. *Default = Off.*



SCNDLY200.
200 milliseconds



SCNDLY400.
400 milliseconds



SCNDLY0.
* Off (no)

User-Specified Aimer Delay

If you want to set your own length for the duration of the delay, scan the barcode below, then set the time-out by scanning digits (0 - 4,000 ms) from the [Programming Chart](#), beginning on page 222, then scan **Save**.



SCNDLY.
Delay Duration

Aimer Mode

This feature allows you to turn the aimer On and Off. When the Interlaced barcode is scanned, the aimer is interlaced with the illumination LEDs. *Default = Interlaced.*



SCNAIM0.
Off



SCNAIM2.
* Interlaced

Centering

Use Centering to narrow the scanner's field of view to make sure that when the scanner is hand-held, it reads only those barcodes intended by the user. For instance, if multiple codes are placed closely together, centering will insure that only the desired codes are read. (Centering can be used in conjunction with [Aimer Delay](#) (see page 50), for the most error-free operation in applications where multiple codes are spaced closely together. Using the Aimer Delay and Centering features, the scanner can emulate the operation of older systems, such as linear laser barcode scanners.)

Note: To adjust centering when the scanner is in Presentation Mode, see [Presentation Centering](#) on page 42.

If a barcode is not touched by a predefined window, it will not be decoded or output by the scanner. If Centering On is checked, the scanner only reads codes that pass through the centering window you specify using the Top of Centering Window, Bottom of Centering Window, Left, and Right of Centering Window selections.

In the example below, the white box is the centering window. The centering window has been set to 20% left, 30% right, 8% top, and 25% bottom. Since Barcode 1 passes through the centering window, it will be read. Barcode 2 does not pass through the centering window, so it will not be read.

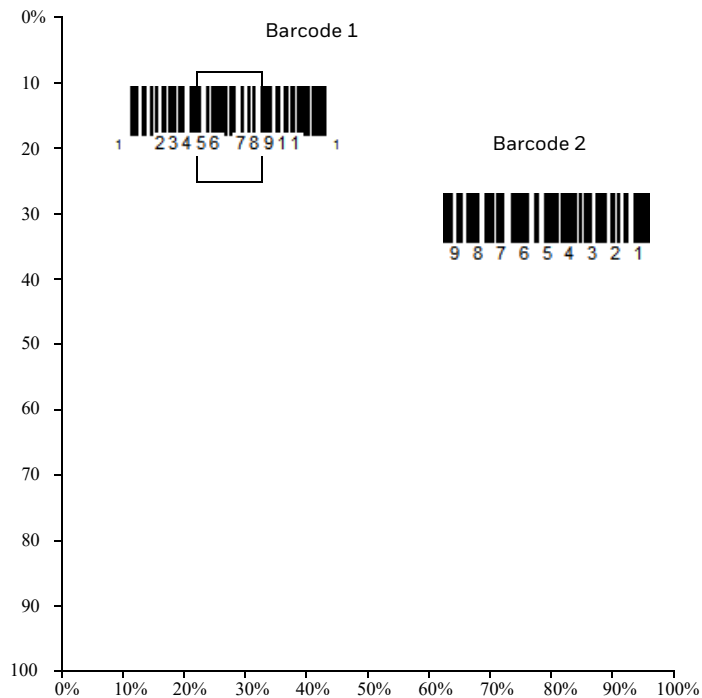

Note: A barcode needs only to be touched by the centering window in order to be read. It does not need to pass completely through the centering window.

Scan Centering On, then scan one of the following barcodes to change the top, bottom, left, or right of the centering window. Then scan the percent you want to shift the centering window using digits from the [Programming Chart](#), beginning on page 222, and scan **Save**. *Default Centering = 40% for Top and Left, 60% for Bottom and Right.*



DECWIN1.
Centering On



DECWIND.
* Centering Off



DECTOP.
Top of Centering Window



DECBOT.
Bottom of Centering Window



DECLFT.
Left of Centering Window



DECRGT.
Right of Centering Window

Preferred Symbology

The scanner can be programmed to specify one symbology as a higher priority over other symbologies in situations where both barcode symbologies appear on the same label, but the lower priority symbology cannot be disabled.

For example, you may be using the scanner in a retail setting to read U.P.C. symbols, but have occasional need to read a code on a drivers license. Since some licenses have a Code 39 symbol as well as the PDF417 symbol, you can use Preferred Symbology to specify that the PDF417 symbol be read instead of the Code 39.

Preferred Symbology classifies each symbology as high priority, low priority, or as an unspecified type. When a low priority symbology is presented, the scanner ignores it for a set period of time (see [Preferred Symbology Time-out](#) on page 54) while it searches for the high priority symbology. If a high priority symbology is located during this period, then that data is read immediately.

If the time-out period expires before a high priority symbology is read, the scanner will read any barcode in its view (low priority or unspecified). If there is no barcode in the scanner's view after the time-out period expires, then no data is reported.

Note: A low priority symbol must be centered on the aiming pattern to be read.

Scan a barcode below to enable or disable Preferred Symbology. *Default = Preferred Symbology Off.*



High Priority Symbology

To specify the high priority symbology, scan the High Priority Symbology barcode below. On the [Symbology Charts](#) on page 211, find the symbology you want to set as high priority. Locate the Hex value for that symbology and scan the 2 digit hex value from the [Programming Chart](#), beginning on page 222. Scan **Save** to save your selection. *Default = None*



Low Priority Symbology

To specify the low priority symbology, scan the Low Priority Symbology barcode below. On the [Symbology Charts](#) on page 211, find the symbology you want to set as low priority. Locate the Hex value for that symbology and scan the 2 digit hex value from the [Programming Chart](#), beginning on page 222.

If you want to set additional low priority symbologies, scan FF, then scan the 2 digit hex value from the Programming Chart for the next symbology. You can program up to 5 low priority symbologies. Scan **Save** to save your selection. *Default = None.*



Preferred Symbology Time-out

Once you have enabled Preferred Symbology and entered the high and low priority symbologies, you must set the time-out period. This is the period of time the scanner will search for a high priority barcode after a low priority barcode has been encountered. Scan the barcode below, then set the delay (from 1-3,000 milliseconds) by scanning digits from the [Programming Chart](#), beginning on page 222, then scanning **Save**. *Default = 500 ms.*



Preferred Symbology Default

Scan the barcode below to set all Preferred Symbology entries to their default values.



Output Sequence Overview

Output Sequence Editor

This programming selection allows you to program the scanner to output data (when scanning more than one symbol) in whatever order your application requires, regardless of the order in which the barcodes are scanned. Reading the **Default Sequence** symbol programs the scanner to the Universal values, shown below. These are the defaults. Be certain you want to delete or clear all formats before you read the **Default Sequence** symbol.

Note: *To make Output Sequence Editor selections, you'll need to know the code I.D., code length, and character match(es) your application requires. Use the Alphanumeric symbols from the [Programming Chart](#), beginning on page 222. You must hold the trigger while reading each barcode in the sequence.*

To Add an Output Sequence

1. Scan the *Enter Sequence* symbol (see [Require Output Sequence](#), page 57).
2. **Code I.D.**
On the [Symbology Charts](#) on page 211, find the symbology to which you want to apply the output sequence format. Locate the Hex value for that symbology

and scan the 2 digit hex value from the [Programming Chart](#), beginning on page 222.

3. **Length**
Specify what length (up to 9999 characters) of data output will be acceptable for this symbology. Scan the four digit data length from the [Programming Chart](#), beginning on page 222. (Note: 50 characters is entered as 0050. 9999 is a universal number, indicating all lengths.) When calculating the length, you must count any programmed prefixes, suffixes, or formatted characters as part of the length (unless using 9999).
4. **Character Match Sequences**
On the [ASCII Conversion Chart \(Code Page 1252\)](#) on page 214, find the Hex value that represents the character(s) you want to match. Use the [Programming Chart](#), beginning on page 222, to read the alphanumeric combination that represents the ASCII characters. (99 is the Universal number, indicating all characters.)
5. **End Output Sequence Editor**
Scan **FF** to enter an Output Sequence for an additional symbology, or **Save** to save your entries.

Other Programming Selections

Discard exits without saving any Output Sequence changes.

Output Sequence Example

In this example, you are scanning Code 93, Code 128, and Code 39 barcodes, but you want the scanner to output Code 39 1st, Code 128 2nd, and Code 93 3rd, as shown below.

Note: Code 93 must be enabled to use this example.



A - Code 39



B - Code 128



C - Code 93

You would set up the sequence editor with the following command line:

SEQBLK62999941FF6A999942FF69999943FF

The breakdown of the command line is shown below:

SEQBLK sequence editor start command

62	code identifier for Code 39
9999	code length that must match for Code 39, 9999 = all lengths
41	start character match for Code 39, 41h = "A"
FF	termination string for first code
6A	code identifier for Code 128
9999	code length that must match for Code 128, 9999 = all lengths
42	start character match for Code 128, 42h = "B"
FF	termination string for second code
69	code identifier for Code 93
9999	code length that must match for Code 93, 9999 = all lengths
43	start character match for Code 93, 43h = "C"
FF	termination string for third code

To program the previous example using specific lengths, you would have to count any programmed prefixes, suffixes, or formatted characters as part of the length. If you use the example on [page 55](#), but assume a <CR> suffix and specific code lengths, you would use the following command line:

SEQBLK62001241FF6A001342FF69001243FF

The breakdown of the command line is shown below:

SEQBLK	sequence editor start command
62	code identifier for Code 39
0012	A - Code 39 sample length (11) plus CR suffix (1) = 12
41	start character match for Code 39, 41h = "A"
FF	termination string for first code
6A	code identifier for Code 128
0013	B - Code 128 sample length (12) plus CR suffix (1) = 13
42	start character match for Code 128, 42h = "B"
FF	termination string for second code
69	code identifier for Code 93
0012	C - Code 93 sample length (11) plus CR suffix (1) = 12
43	start character match for Code 93, 43h = "C"
FF	termination string for third code

Output Sequence Editor



SEQBLK.
Enter Sequence



SEQDFT.
Default Sequence

Partial Sequence

If an output sequence operation is terminated before all your output sequence criteria are met, the barcode data acquired to that point is a “partial sequence.”

Scan Discard Partial Sequence to discard partial sequences when the output sequence operation is terminated before completion. Scan Transmit Partial Sequence to transmit partial sequences. (Any fields in the sequence where no data match occurred will be skipped in the output.)



SEQTTS1.
Transmit Partial Sequence



SEQTTS0.
* Discard Partial Sequence

Require Output Sequence

When an output sequence is Required, all output data must conform to an edited sequence or the scanner will not transmit the output data to the host device. When it's On/Not Required, the scanner will attempt to get the output data to conform to an edited sequence but, if it cannot, the scanner transmits all output data to the host device as is.

When the output sequence is Off, the barcode data is output to the host as the scanner decodes it. *Default = Off.*

Note: *This selection is unavailable when the Multiple Symbols Selection is turned On.*



SEQ_EN2.
Required



Multiple Symbols

When this programming selection is turned On, it allows you to read multiple symbols with a single push of the scanner's button. If you push and hold the button, aiming the scanner at a series of symbols, it reads unique symbols once, beeping (if turned On) for each read. The scanner attempts to find and decode new symbols as long as the button is pushed. When this programming selection is turned Off, the scanner will only read the symbol closest to the aiming beam. *Default = Off.*



No Read

With No Read turned On, the scanner notifies you if a code cannot be read. If using an EZConfig Tool Scan Data Window (see page [172](#)), an "NR" appears when a code cannot be read. If No Read is turned Off, the "NR" will not appear. *Default = Off.*



If you want a different notation than "NR," for example, "Error," or "Bad Code," you can edit the output message 0. The hex code for the No Read symbol is 9C.

Video Reverse

Video Reverse is used to allow the scanner to read barcodes that are inverted. The Video Reverse Off barcode below is an example of this type of barcode. Scan Video Reverse Only to read *only* inverted barcodes. Scan Video Reverse and Standard Barcodes to read both types of codes.

Note: After scanning *Video Reverse Only*, menu barcodes cannot be read. You must scan *Video Reverse Off* or *Video Reverse and Standard Barcodes* in order to read menu barcodes.

Note: Images downloaded from the unit are not reversed. This is a setting for decoding only.



VIDREV1.

Video Reverse Only



VIDREV2

Video Reverse and Standard Barcodes



VIDREV0.

*** Video Reverse Off**

Working Orientation

Some barcodes are direction-sensitive. For example, KIX codes and OCR can misread when scanned sideways or upside down. Use the working orientation settings if your direction-sensitive codes will not usually be presented upright to the scanner. *Default = Upright.*

Upright:



Upside Down:



Vertical, Top to Bottom:
(Rotate CW 90°)



Vertical, Bottom to Top:
(Rotate CCW 90°)



ROTATN0.

*** Upright**



ROTATN1.

Vertical, Bottom to Top



ROTATN2.

Upside Down



ROTATN3.

Vertical, Top to Bottom

Prefix/Suffix Overview

When a barcode is scanned, additional information is sent to the host computer along with the barcode data. This group of barcode data and additional, user-defined data is called a “message string.” The selections in this section are used to build the user-defined data into the message string.

Prefix and Suffix characters are data characters that can be sent before and after scanned data. You can specify if they should be sent with all symbologies, or only with specific symbologies. The following illustration shows the breakdown of a message string:

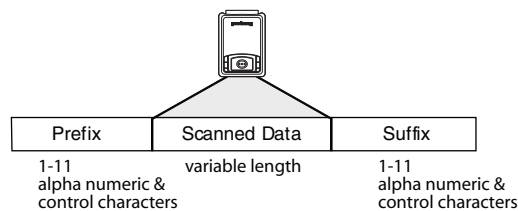

Points to Keep In Mind

- It is not necessary to build a message string. The selections in this chapter are only used if you wish to alter the default settings. *Default prefix = None. Default suffix = None.*
- A prefix or suffix may be added or cleared from one symbology or all symbologies.
- You can add any prefix or suffix from the [ASCII Conversion Chart \(Code Page 1252\)](#) on page 214, plus Code I.D. and AIM I.D.
- You can string together several entries for several symbologies at one time.
- Enter prefixes and suffixes in the order in which you want them to appear on the output.

- When setting up for specific symbologies (as opposed to all symbologies), the specific symbology ID value counts as an added prefix or suffix character.
- The maximum size of a prefix or suffix configuration is 200 characters, which includes header information.

To Add a Prefix or Suffix:

- Step 1. Scan the Add Prefix or Add Suffix symbol (see page 64).
- Step 2. Determine the 2 digit Hex value from the Symbology Chart (included in the [Symbology Charts](#) on page 211) for the symbology to which you want to apply the prefix or suffix. For example, for Code 128, Code ID is “j” and Hex ID is “6A”.
- Step 3. Scan the 2 hex digits from the [Programming Chart](#), beginning on page 222, or scan 9, 9 for all symbologies.
- Step 4. Determine the hex value from the [ASCII Conversion Chart \(Code Page 1252\)](#) on page 214, for the prefix or suffix you wish to enter.

Note: To add the Code I.D., scan 5, C, 8, 0.

To add AIM I.D., scan 5, C, 8, 1.

To add a backslash (\), scan 5, C, 5, C.

To add a backslash (\), you must scan 5C twice – once to create the leading backslash and then to create the backslash itself.

- Step 5. Scan the 2 digit hex value from the [Programming Chart](#), beginning on page 222.
 - Step 6. Repeat Steps 4 and 5 for every prefix or suffix character.
 - Step 7. Scan **Save** to exit and save, or scan **Discard** to exit without saving.
- Repeat Steps 1-6 to add a prefix or suffix for another symbology.

Example: Add a Tab Suffix to All Symbologies

- Step 1. Scan Add Suffix.
- Step 2. Scan 9, 9 from the [Programming Chart](#), beginning on page 222, to apply this suffix to all symbologies.
- Step 3. Scan 0, 9 from the [Programming Chart](#), beginning on page 222. This corresponds with the hex value for a horizontal tab, shown in the [ASCII Conversion Chart \(Code Page 1252\)](#) on page 214.
- Step 4. Scan **Save**, or scan **Discard** to exit without saving.

To Clear One or All Prefixes or Suffixes

You can clear a single prefix or suffix, or clear all prefixes/suffixes for a symbology. If you have been entering prefixes and suffixes for single symbologies, you can use Clear One Prefix (Suffix) to delete a specific character from a symbology. When you Clear All Prefixes (Suffixes), all the prefixes or suffixes for a symbology are deleted.

- Step 1. Scan the Clear One Prefix or Clear One Suffix symbol.
- Step 2. Determine the 2 digit Hex value from the Symbology Chart (included in the [Symbology Charts](#) on page 211) for the symbology from which you want to clear the prefix or suffix.
- Step 3. Scan the 2 digit hex value from the [Programming Chart](#), beginning on page 222, or scan 9, 9 for all symbologies.

Your change is automatically saved.

To Add a Carriage Return Suffix to All Symbologies

Scan the following barcode if you wish to add a carriage return suffix to all symbologies at once. This action first clears all current suffixes, then programs a carriage return suffix for all symbologies.



VSUFCR.

**Add CR Suffix
All Symbologies**

Prefix Selections



PREBK2.
Add Prefix



PRECL2.
Clear One Prefix



PRECA2.
Clear All Prefixes

Suffix Selections



SUFBK2.
Add Suffix



SUFCL2.
Clear One Suffix



SUFCA2.
Clear All Suffixes

Function Code Transmit

When this selection is enabled and function codes are contained within the scanned data, the scanner transmits the function code to the terminal. Charts of these function codes are provided in [ASCII Conversion Chart \(Code Page 1252\)](#) on page 214 . When the scanner is in keyboard wedge mode, the scan code is converted to a key code before it is transmitted. *Default = Enable.*



RMVFNC0.
* Enable



RMVFNC1.
Disable

Intercharacter, Interfunction, and Intermessage Delays

Some terminals drop information (characters) if data comes through too quickly. Intercharacter, interfunction, and intermessage delays slow the transmission of data, increasing data integrity.

Intercharacter Delay

An intercharacter delay of up to 5000 milliseconds (in 5ms increments) may be placed between the transmission of each character of scanned data. Scan the Intercharacter Delay barcode below, then scan the number of 5ms delays, and the **Save** barcode using the [Programming Chart](#), beginning on page 222.

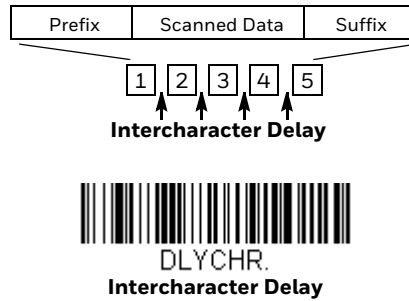

To remove this delay, scan the Intercharacter Delay barcode, then set the number of delays to 0. Scan the **Save** barcode using the [Programming Chart](#), beginning on page 222.

Note: *Intercharacter delays are not supported in USB serial.*

User Specified Intercharacter Delay

An intercharacter delay of up to 5000 milliseconds (in 5ms increments) may be placed after the transmission of a particular character of scanned data. Scan the Delay Length barcode below, then scan the number of 5ms delays, and the **Save** barcode from the [Programming Chart](#), beginning on page 222.

Next, scan the Character to Trigger Delay barcode, then the 2-digit hex value for a printable character to trigger the delay (see [Symbology Charts](#) on page 211).



To remove this delay, scan the Delay Length barcode, and set the number of delays to 0. Scan the **Save** barcode from the [Programming Chart](#), beginning on page 222.

Interfunction Delay

An interfunction delay of up to 5000 milliseconds (in 5ms increments) may be placed between the transmission of each control character in the message string. Scan the Interfunction Delay barcode below, then scan the number of 5ms delays, and the **Save** barcode from the [Programming Chart](#), beginning on page 222.

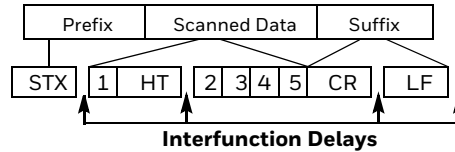

DLYFNC.

Interfunction Delay

To remove this delay, scan the Interfunction Delay barcode, then set the number of delays to 0. Scan the **Save** barcode using the [Programming Chart](#), beginning on page 222.

Intermessage Delay

An intermessage delay of up to 5000 milliseconds (in 5ms increments) may be placed between each scan transmission. Scan the Intermesssage Delay barcode below, then scan the number of 5ms delays, and the **Save** barcode from the [Programming Chart](#), beginning on page 222.

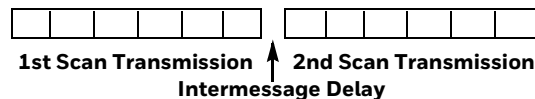

DLYMSG.

Intermessage Delay

To remove this delay, scan the Intermesssage Delay barcode, then set the number of delays to 0. Scan the **Save** barcode from the [Programming Chart](#), beginning on page 222.

Data Format Editor Introduction

You may use the Data Format Editor to change the scanner's output. For example, you can use the Data Format Editor to insert characters at certain points in barcode data as it is scanned. The selections in the following pages are used only if you wish to alter the output. *Default Data Format setting = None.*

Normally, when you scan a barcode, it is output automatically. However, when you create a format, you must use a "send" command (see [Send Commands](#) on page 70) within the format program to output data.

Multiple formats may be programmed into the scanner. They are stacked in the order in which they are entered. However, the following list presents the order in which formats are applied:

1. Specific Terminal ID, Actual Code ID, Actual Length
2. Specific Terminal ID, Actual Code ID, Universal Length
3. Specific Terminal ID, Universal Code ID, Actual Length
4. Specific Terminal ID, Universal Code ID, Universal Length
5. Universal Terminal ID, Actual Code ID, Actual Length
6. Universal Terminal ID, Actual Code ID, Universal Length
7. Universal Terminal ID, Universal Code ID, Actual Length
8. Universal Terminal ID, Universal Code ID, Universal Length

The maximum size of a data format configuration is 2000 bytes, which includes header information.

If a barcode is read that fails the first data format, the next data format, if there is one, will be used on the barcode data. If there is no other data format, the raw data is output.

If you have changed data format settings, and wish to clear all formats and return to the factory defaults, scan the Default Data Format code below.



Add a Data Format

- Step 1. Scan the **Enter Data Format** symbol (see page 69).
- Step 2. **Select Primary/Alternate Format**
Determine if this will be your primary data format, or one of 3 alternate formats. This allows you to save a total of 4 different data formats. To program your primary format, scan **0** from the [Programming Chart](#), beginning on page 222. If you are programming an alternate format, scan **1**, **2**, or **3**, depending on which alternate format you are programming. (see [Primary/Alternate Data Formats](#) on page 85 for further information.)
- Step 3. **Terminal Type**
Refer to [Terminal ID Table](#) on page 70 and locate the Terminal ID number for your PC. Scan three numeric barcodes from the [Programming Chart](#), beginning on page 222, to program the scanner for your terminal ID (you must enter 3 digits). For example, scan **0 0 3** for an AT wedge.

Note: **099** indicates all terminal types.

- Step 4. **Code I.D.**
In the [Symbology Charts](#) on page 211, find the symbology to which you want to apply the data format. Locate the Hex value for that symbology and scan the 2 digit hex value from the [Programming Chart](#), beginning on page 222.

If you wish to create a data format for all symbologies, with the exception of some specific symbologies, refer to B8 (see page 83).

If you are creating a data format for Batch Mode Quantity, use **35** for the Code I.D.

Note: **99** indicates all symbologies.

- Step 5. **Length**
Specify what length (up to 9999 characters) of data will be acceptable for this symbology. Scan the four digit data length from the [Programming Chart](#), beginning on page 222. For example, 50 characters is entered as **0050**.

Note: **9999** indicates all lengths.

- Step 6. **Editor Commands**
Refer to [Data Format Editor Commands](#) on page 70. Scan the symbols that represent the command you want to enter.

Step 7. Scan **Save** to save your data format, or **Discard** to exit without saving your changes.



Other Programming Selections

- **Clear One Data Format**
This deletes one data format for one symbology. If you are clearing the primary format, scan **0** from the [Programming Chart](#), beginning on page 222. If you are clearing an alternate format, scan **1**, **2**, or **3**, depending on the format you are clearing. Scan the Terminal Type and Code I.D. (see [Symbology Charts](#) on page 211), and the barcode data length for the specific data format that you want to delete. All other formats remain unaffected.
- **Clear all Data Formats**
This clears all data formats.
- **Save**
Exit and save your data format changes.
- **Discard**
Exit without saving any data format changes.



Terminal ID Table

Terminal	Model(s)	Terminal ID
USB	PC keyboard (HID)	124
	Mac Keyboard	125
	PC Keyboard (Japanese)	134
	Serial (COM driver required)	130
	HID POS	131
	USB SurePOS Handheld	128
Serial	USB SurePOS Tabletop	129
	RS232 TTL	000
	RS232 True	000
Keyboard	RS485 (IBM-HHBCR 1+2, 46xx)	051
	PS2 compatibles	003
	AT compatibles	002

Data Format Editor Commands

When working with the Data Format Editor, a virtual cursor is moved along your input data string. The following commands are used to both move this cursor to different positions, and to select, replace, and insert data into the final output.

Send Commands

Send all characters

- F1** Include in the output message all of the characters from the input message, starting from current cursor position, followed by an insert character. *Syntax = F1xx*, where xx stands for the insert character's hex value for its ASCII code. Refer to the [ASCII Conversion Chart \(Code Page 1252\)](#) on page 214 for decimal, hex, and character codes.

Send a number of characters

- F2** Include in the output message a number of characters followed by an insert character. Start from the current cursor position and continue for "nn" characters or through the last character in the input message, followed by character "xx." *Syntax = F2nxxx*, where nn stands for the numeric value (00-99) for the number of characters, and xx stands for the insert character's hex value for its ASCII code. Refer to the [ASCII Conversion Chart \(Code Page 1252\)](#) on page 214 for decimal, hex, and character codes.

F2 Example: Send a number of characters



Send the first 10 characters from the barcode above, followed by a carriage return.
Command string: F2100D

F2 is the “Send a number of characters” command

10 is the number of characters to send

0D is the hex value for a CR

The data is output as: **1234567890**

F2 and F1 Example: Split characters into 2 lines

Send the first 10 characters from the barcode above, followed by a carriage return, followed by the rest of the characters.

Command string: **F2100DF10D**

F2 is the “Send a number of characters” command

10 is the number of characters to send for the first line

0D is the hex value for a CR

F1 is the “Send all characters” command

0D is the hex value for a CR

The data is output as:

1234567890

ABCDEFGHIJ

<CR>

Send all characters up to a particular character

- F3** Include in the output message all characters from the input message, starting with the character at the current cursor position and continuing to, but not including, the search character “ss,” followed by an insert character. The cursor is moved forward to the “ss” character. *Syntax = F3ssxx*, where ss stands for the search character’s hex value for its ASCII code, and xx stands for the insert character’s hex value for its ASCII code. Refer to the [ASCII Conversion Chart \(Code Page 1252\)](#) on page 214 for decimal, hex, and character codes.

F3 Example: Send all characters up to a particular character



Using the barcode above, send all characters up to but not including “D,” followed by a carriage return.

Command string: **F3440D**

F3 is the “Send all characters up to a particular character” command

44 is the hex value for a 'D’

0D is the hex value for a CR

The data is output as:

1234567890ABC

<CR>

Send all characters up to a string

B9 Include in the output message all characters from the input message, starting with the character at the current cursor position and continuing to, but not including, the search string “s...s.” The cursor is moved forward to the beginning of the “s...s” string. *Syntax = B9nnns...s*, where nnnn stands for the length of the string, and s...s stands for the string to be matched. The string is made up of hex values for the characters in the string. Refer to the [ASCII Conversion Chart \(Code Page 1252\)](#) on page 214 for decimal, hex and, character codes.

B9 Example: Send all characters up to a defined string



Using the barcode above, send all characters up to but not including “AB.”

Command string: **B900024142**

B9 is the “Send all characters up to a string” command

0002 is the length of the string (2 characters)

41 is the hex value for A

42 is the hex value for B

The data is output as: **1234567890**

Send all but the last characters

E9 Include in the output message all but the last “nn” characters, starting from the current cursor position. The cursor is moved forward to one position past the last input message character included. *Syntax = E9nn*, where nn stands for the numeric value (00-99) for the number of characters that will not be sent at the end of the message.

Insert a character multiple times

F4 Send “xx” character “nn” times in the output message, leaving the cursor in the current position. *Syntax = F4xxnn*, where xx stands for the insert character’s hex value for its ASCII code, and nn is the numeric value (00-99) for the number of times it should be sent. Refer to the [ASCII Conversion Chart \(Code Page 1252\)](#) on page 214 for decimal, hex, and character codes.

E9 and F4 Example: Send all but the last characters, followed by 2 tabs



Send all characters except for the last 8 from the barcode above, followed by 2 tabs.

Command string: **E908F40902**

E9 is the “Send all but the last characters” command

08 is the number of characters at the end to ignore

F4 is the “Insert a character multiple times” command

09 is the hex value for a horizontal tab

02 is the number of times the tab character is sent

The data is output as: **1234567890AB <tab><tab>**

Insert a string

BA Send “ss” string of “nn” length in the output message, leaving the cursor in the current position. *Syntax = BAnnnns...s*, where nnnn stands for the length of the string, and s...s stands for the string. The string is made up of hex values for the characters in the string. Refer to the [ASCII Conversion Chart \(Code Page 1252\)](#) on page 214 for decimal, hex, and character codes.

B9 and BA Example: Look for the string “AB” and insert 2 asterisks ()**



Using the barcode above, send all characters up to but not including “AB.” Insert 2 asterisks at that point, and send the rest of the data with a carriage return after.

Command string: **B900024142BA00022A2AF10D**

B9 is the “Send all characters up to a string” command

0002 is the length of the string (2 characters)

41 is the hex value for A

42 is the hex value for B

BA is the “Insert a string” command

0002 is the length of the string to be added (2 characters)

2A is the hex value for an asterisk (*)

2A is the hex value for an asterisk (*)

F1 is the “Send all characters” command

0D is the hex value for a CR

The data is output as:

1234567890ABCDEFGHJ**

<CR>

Insert symbology name

- B3** Insert the name of the barcode’s symbology in the output message, without moving the cursor. Only symbologies with a Honeywell ID are included (see [Symbology Charts](#) on page 211). Refer to the [ASCII Conversion Chart \(Code Page 1252\)](#) on page 214 for decimal, hex, and character codes.

Insert barcode length

- B4** Insert the barcode’s length in the output message, without moving the cursor. The length is expressed as a numeric string and does not include leading zeros.

B3 and B4 Example: Insert the symbology name and length



Send the symbology name and length before the barcode data from the barcode above. Break up these insertions with spaces. End with a carriage return.

Command string: **B3F42001B4F42001F10D**

B3 is the “Insert symbology name” command

F4 is the “Insert a character multiple times” command

20 is the hex value for a space

01 is the number of times the space character is sent

B4 is the “Insert barcode length” command

F4 is the “Insert a character multiple times” command

20 is the hex value for a space

01 is the number of times the space character is sent

F1 is the “Send all characters” command

OD is the hex value for a CR

The data is output as:

Code128 20 1234567890ABCDEFGHIJ
<CR>

Insert key strokes

B5 Insert a key stroke or combination of key strokes. Key strokes are dependent on your keyboard (see [Keyboard Key References](#) on page 220). Any key can be inserted, including arrows and functions. *Syntax* = 5CB5xxssnn, where xx is the number of keys pressed (without key modifiers), ss is the key modifier from the table below, and nn is the key number from the [Keyboard Key References](#) on page 220.

Key Modifiers	Hex
No Key Modifier	00
Shift Left	01
Shift Right	02
Alt Left	04
Alt Right	08
Control Left	10
Control Right	20

- For example, B501021F inserts an “A” on a 104 key, U.S. style keyboard. B5 = the command, 01 = number of key press events (without the key modifier), 02 is the key modifier for Shift Right, and 1F is the “a” key. If a lower case “a” were to be inserted, B501001F would be entered.

If there are three keystrokes, the syntax would change from B5xxssnn for one keystroke to B5xxssnnssnnssnn. An example that would insert "abc" is as follows: B503001F00320030F833.

Note: *Key modifiers can be added together when needed. The sum is converted to hexadecimals.*

Example: Control Left+Shift Left = 17, converted to hexadecimal = 11.

Move Commands

Move the cursor forward a number of characters

F5 Move the cursor ahead “nn” characters from current cursor position. *Syntax* = F5nn, where nn is the numeric value (00-99) for the number of characters the cursor should be moved ahead.

F5 Example: Move the cursor forward and send the data



Move the cursor forward 3 characters, then send the rest of the barcode data from the barcode above. End with a carriage return.

Command string: **F503F10D**

F5 is the “Move the cursor forward a number of characters” command

03 is the number of characters to move the cursor

F1 is the “Send all characters” command

0D is the hex value for a CR

The data is output as:

4567890ABCDEFGHIJ
<CR>

Move the cursor backward a number of characters

- F6** Move the cursor back “nn” characters from current cursor position.
Syntax = F6nn, where nn is the numeric value (00-99) for the number of characters the cursor should be moved back.

Move the cursor to the beginning

- F7** Move the cursor to the first character in the input message. *Syntax = F7.*

FE and F7 Example: Manipulate barcodes that begin with a 1



Search for barcodes that begin with a 1. If a barcode matches, move the cursor back to the beginning of the data and send 6 characters followed by a carriage return. Using the barcode above:

Command string: **FE31F7F2060D**

FE is the “Compare characters” command

31 is the hex value for 1

F7 is the “Move the cursor to the beginning” command

F2 is the “Send a number of characters” command

06 is the number of characters to send

0D is the hex value for a CR

The data is output as:

123456
<CR>

Move the cursor to the end

EA Move the cursor to the last character in the input message. *Syntax = EA.*

Search Commands

Search forward for a character

F8 Search the input message forward for “xx” character from the current cursor position, leaving the cursor pointing to the “xx” character. *Syntax = F8xx*, where xx stands for the search character’s hex value for its ASCII code. Refer to the [ASCII Conversion Chart \(Code Page 1252\)](#) on page 214 for decimal, hex, and character codes.

F8 Example: Send barcode data that starts after a particular character



Search for the letter “D” in barcodes and send all the data that follows, including the “D.” Using the barcode above:

Command string: **F844F10D**

F8 is the “Search forward for a character” command

44 is the hex value for “D”

F1 is the “Send all characters” command

0D is the hex value for a CR

The data is output as:

DEFGHIJ
<CR>

Search backward for a character

F9 Search the input message backward for “xx” character from the current cursor position, leaving the cursor pointing to the “xx” character. *Syntax = F9xx*, where xx stands for the search character’s hex value for its ASCII code. Refer to the [ASCII Conversion Chart \(Code Page 1252\)](#) on page 214 for decimal, hex, and character codes.

Search forward for a string

B0 Search forward for “s” string from the current cursor position, leaving cursor pointing to “s” string. *Syntax = B0nnnnS*, where nnnn is the string length (up to 9999), and S consists of the ASCII hex value of each character in the match string. For example, B0000454657374 will search forward for the first occurrence of the 4 character string “Test.” Refer to the [ASCII Conversion Chart \(Code Page 1252\)](#) on page 214 for decimal, hex, and character codes.

B0 Example: Send barcode data that starts after a string of characters



Search for the letters “FGH” in barcodes and send all the data that follows, including “FGH.” Using the barcode above:

Command string: **B00003464748F10D**

B0 is the “Search forward for a string” command

0003 is the string length (3 characters)

46 is the hex value for “F”

47 is the hex value for “G”

48 is the hex value for “H”

F1 is the “Send all characters” command

0D is the hex value for a CR

The data is output as:

FGHIJ

<CR>

Search backward for a string

B1 Search backward for “s” string from the current cursor position, leaving cursor pointing to “s” string. *Syntax = B1nnnnS*, where nnnn is the string length (up to 9999), and S consists of the ASCII hex value of each character in the match string. For example, B1000454657374 will search backward for the first occurrence of the 4 character string “Test.” Refer to the [ASCII Conversion Chart \(Code Page 1252\)](#) on page 214 for decimal, hex and character codes.

Search forward for a non-matching character

E6 Search the input message forward for the first non-“xx” character from the current cursor position, leaving the cursor pointing to the non-“xx” character. *Syntax = E6xx* where xx stands for the search character’s hex value for its ASCII code. Refer to the [ASCII Conversion Chart \(Code Page 1252\)](#) on page 214 for decimal, hex and character codes.

E6 Example: Remove zeros at the beginning of barcode data



This example shows a barcode that has been zero filled. You may want to ignore the zeros and send all the data that follows. E6 searches forward for the first character that is not zero, then sends all the data after, followed by a carriage return. Using the barcode above:

Command string: **E630F10D**

E6 is the “Search forward for a non-matching character” command

30 is the hex value for 0

F1 is the “Send all characters” command

0D is the hex value for a CR

The data is output as:

37692

<CR>

Search backward for a non-matching character

- E7** Search the input message backward for the first non-“xx” character from the current cursor position, leaving the cursor pointing to the non-“xx” character. *Syntax = E7xx*, where xx stands for the search character’s hex value for its ASCII code. Refer to the [ASCII Conversion Chart \(Code Page 1252\)](#) on page 214 for decimal, hex, and character codes.

Miscellaneous Commands

Suppress characters

- FB** Suppress all occurrences of up to 15 different characters, starting at the current cursor position, as the cursor is advanced by other commands. When the FC command is encountered, the suppress function is terminated. The cursor is not moved by the FB command. *Syntax = FBnnxxyy . .zz*, where nn is a count of the number of suppressed characters in the list, and xxyy ..zz is the list of characters to be suppressed.

FB Example: Remove spaces in barcode data



This example shows a barcode that has spaces in the data. You may want to remove the spaces before sending the data. Using the barcode above:

Command string: **FB0120F10D**

FB is the “Suppress characters” command
01 is the number of character types to be suppressed
20 is the hex value for a space
F1 is the “Send all characters” command
0D is the hex value for a CR

The data is output as:
34567890
<CR>

Stop suppressing characters

FC Disables suppress filter and clear all suppressed characters. *Syntax = FC.*

Replace characters

E4 Replaces up to 15 characters in the output message, without moving the cursor. Replacement continues until the E5 command is encountered. *Syntax = E4nnxx₁xx₂yy₁yy₂...zz₁zz₂*, where nn is the total count of the number of characters in the list (characters to be replaced plus replacement characters); xx₁ defines characters to be replaced and xx₂ defines replacement characters, continuing through zz₁ and zz₂.

E4 Example: Replace zeros with CRs in barcode data



If the barcode has characters that the host application does not want included, you can use the E4 command to replace those characters with something else. In this example, you will replace the zeros in the barcode above with carriage returns.

Command string: **E402300DF10D**

E4 is the “Replace characters” command

02 is the total count of characters to be replaced, plus the replacement characters (0 is replaced by CR, so total characters = 2)

30 is the hex value for 0

0D is the hex value for a CR (the character that will replace the 0)

F1 is the “Send all characters” command

0D is the hex value for a CR

The data is output as:

1234
5678
ABC
<CR>

Stop replacing characters

E5 Terminates character replacement. *Syntax = E5.*

Compare characters

FE Compare the character in the current cursor position to the character “xx.” If characters are equal, move the cursor forward one position. *Syntax = FExx*, where xx stands for the comparison character’s hex value for its ASCII code. Refer to the [ASCII Conversion Chart \(Code Page 1252\)](#) on page 214 for decimal, hex, and character codes.

Compare string

B2 Compare the string in the input message to the string “s.” If the strings are equal, move the cursor forward past the end of the string. *Syntax = B2nnnnS*, where nnnn is the string length (up to 9999), and S consists of the ASCII hex value of each character in the match string. For example, B2000454657374 will compare the string at the current cursor position with the 4 character string “Test.” Refer to the [ASCII Conversion Chart \(Code Page 1252\)](#) on page 214 for decimal, hex, and character codes.

Check for a number

EC Check to make sure there is an ASCII number at the current cursor position. The format is aborted if the character is not numeric.

EC Example: Only output the data if the barcode begins with a number

If you want only data from barcodes that begin with a number, you can use EC to check for the number.

Command string: **ECF10D**

EC is the “Check for a number” command

F1 is the “Send all characters” command

0D is the hex value for a CR

If this barcode is read,  the next data format, if there is one, will
AB1234

be used on the data. If there is no other format, the format fails and the raw data is output as **AB1234**.

If this barcode is read,  the data is output as:
1234AB

1234AB
<CR>

Check for non-numeric character

ED Check to make sure there is a non-numeric ASCII character at the current cursor position. The format is aborted if the character is numeric.

ED Example: Only output the data if the barcode begins with a letter

If you want only data from barcodes that begin with a letter, you can use ED to check for the letter.

Command string: **EDF10D**

ED is the “Check for a non-numeric character” command

F1 is the “Send all characters” command

0D is the hex value for a CR

If this barcode is read,  the next data format, if there is one, will
1234AB

be used on this data. If there is no other format, the format fails and the raw data is output as **1234AB**.

If this barcode is read,  the data is output as:
AB1234

AB1234
<CR>

Insert a delay

EF Inserts a delay of up to 49,995 milliseconds (in multiples of 5), starting from the current cursor position. *Syntax = EFnnnn*, where nnnn stands for the delay in 5ms increments, up to 9999. This command can only be used with keyboard emulation.

Discard Data

B8 Discards types of data. For example, you may want to discard Code 128 barcodes that begin with the letter A. In step 4 ([page 68](#)), select 6A (for Code 128), and in step 5, select 9999 (for all lengths). Enter FE41B8 to compare and discard Code 128 barcodes that begin with the letter A. Syntax = B8.

Note: The B8 command must be entered after all other commands.

The Data Format must be **Required** (see [page 83](#)) in order for the B8 command to work.

If Data Format is On, but Not Required ([page 84](#)), barcode data that meets the B8 format is scanned and output as usual.

Because the data format needs to be **On** and **Required** ([page 84](#)) for the B8 command, you must input data formats for all barcodes you wish to discard as well as all barcodes you wish to output.

Other data format settings impact the B8 command. If Data Format Non-Match Error Tone is On ([page 84](#)), the scanner emits an error tone. If Data format Non-Match Error Tone is Off, the code is disabled for reading and no tone is sounded.

Data Formatter

When Data Formatter is turned Off, the barcode data is output to the host as read, including prefixes and suffixes.



DFM_END.
Data Formatter Off

You may wish to require the data to conform to a data format you have created and saved. The following settings can be applied to your data format:

- **Data Formatter On, Not Required, Keep Prefix/Suffix**
Scanned data is modified according to your data format, and prefixes and suffixes are transmitted.
- **Data Formatter On, Not Required, Drop Prefix/Suffix**
Scanned data is modified according to your data format. If a data format is found for a particular symbol, those prefixes and suffixes are not transmitted. If a data format is *not* found for that symbol, the prefixes and suffixes are transmitted.
- **Data Format Required, Keep Prefix/Suffix**
Scanned data is modified according to your data format, and prefixes and suffixes are transmitted. Any data that does not match your data format requirements generates an error tone and the data in that barcode is not transmitted. If you wish to process this type of barcode without generating an error tone, see [Data Format Non-Match Error Tone](#) on page 84.
- **Data Format Required, Drop Prefix/Suffix**
Scanned data is modified according to your data format. If a data format is

found for a particular symbol, those prefixes and suffixes are not transmitted. Any data that does not match your data format requirements generates an error tone. If you wish to process this type of barcode without generating an error tone, see [Data Format Non-Match Error Tone](#) on page 84.

Choose one of the following options. *Default = Data Formatter On, Not Required, Keep Prefix/Suffix*



DFM_EN1.

* **Data Formatter On,
Not Required,
Keep Prefix/Suffix**



DFM_EN3.

**Data Formatter On,
Not Required,
Drop Prefix/Suffix**



DFM_EN2.

**Data Format Required,
Keep Prefix/Suffix**



DFM_EN4.

**Data Format Required,
Drop Prefix/Suffix**

Data Format Non-Match Error Tone

When a barcode is encountered that doesn't match your required data format, the scanner normally generates an error tone. However, you may want to continue scanning barcodes without hearing the error tone. If you scan the **Data Format Non-Match Error Tone Off** barcode, data that doesn't conform to your data format is not transmitted, and no error tone will sound. If you wish to hear the error tone when a non-matching barcode is found, scan the **Data Format Non-Match Error Tone On** barcode. *Default = Data Format Non-Match Error Tone On.*



DFMDEC0.

* **Data Format Non-Match Error
Tone On**



DFMDEC1.

**Data Format Non-Match
Error Tone Off**

Primary/Alternate Data Formats

You can save up to four data formats and switch between these formats. Your primary data format is saved under **0**. Your other three formats are saved under **1**, **2**, and **3**. To set your device to use one of these formats, scan one of the barcodes below.



ALTFNM0.

Primary Data Format



ALTFNM1.

Data Format 1



ALTFNM2.

Data Format 2



ALTFNM3.

Data Format 3

Single Scan Data Format Change

You can also switch between data formats for a single scan. The next barcode is scanned using an alternate data format, then reverts to the format you have selected above (either Primary, 1, 2, or 3).

For example, you may have set your device to the data format you saved as Data Format 3. You can switch to Data Format 1 for a single trigger pull by scanning the **Single Scan-Data Format 1** barcode below. The next barcode that is scanned uses Data Format 1, then reverts back to Data Format 3.



VSAF_0.

**Single Scan-Primary
Data Format**



VSAF_1.

Single Scan-Data Format 1



VSAF_2.

Single Scan-Data Format 2



VSAF_3.

Single Scan-Data Format 3

EXTERNAL INPUT / OUTPUT

The Vuquest 3320 scanner can be integrated with a variety of third party devices. The External Trigger and Illumination Controls can be configured using the barcodes in this chapter. These controls offer simple trigger signals. An External I/O license and cable are required; contact the nearest technical support office for further information (see [Technical Assistance](#) on page xiii).

External Input

External Trigger Control

The External Trigger Control allows object detection from the third party device to trigger the scanner. If you want to use the third party device object detection, scan the External Trigger Control On barcode. If you want to use the 3320 scanner object detection, scan the External Trigger Control Off barcode. *Default = External Trigger Control Off.*



EXTTRG0.

* External Trigger Control Off



EXTTRG1.

External Trigger Control On

External Trigger Polarity

External Trigger Polarity has two states, High and Low. A digital high polarity is 1 and a digital low polarity is 0. If the third party device triggers on low polarity, 0, scan the External Trigger Polarity Low barcode. *Default = External Trigger Polarity High.*



EXTTP01.

* External Trigger Polarity High



EXTTP00.

External Trigger Polarity Low

External Trigger Parameters

Absolute Maximum		
Maximum Input Voltage	Low Value: -0.5 Volts High Value: +5.5 Volts	The input is protected by an input protection diode on the ground side. The input voltage can be below ground provided it is current limited below the value shown on the next line of this table.
Maximum Input Current	Low Value: -6 Milliamperes	Input protection diode current. The limiting factor on current is the dissipation in the 1K Ω , 0402 resistor (not the gate diode limit).
Parameter Values		
Input Resistance to Ground	Low Value: 9.7 K Ω Nominal Value: 10.0 K Ω High Value: 10.3 K Ω	Pull down resistor loading.
Maximum Input Low Voltage Logical Low Level	High Value: 0.8 Volts	Value does not include harness drops or margin for noise.
Input High Voltage Threshold	Low Value: 2.6 Volts	Value does not include harness drops or margin for noise.

External Trigger Schematic

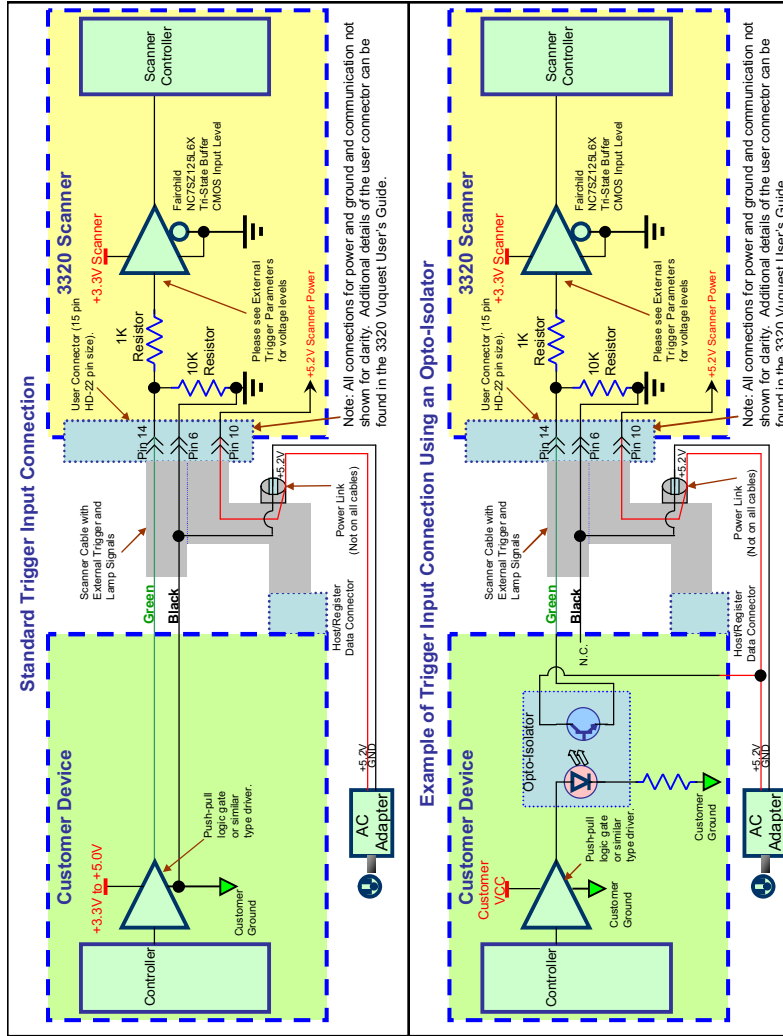

External Output

External Illumination Control

The External Illumination Control allows the third party device to use external illumination, supplemental to the illumination from the scanner. If the illumination will be provided by the third party device, scan the External Illumination Control On barcode. *Default = External Illumination Control Off.*



EXTILLO.

* External Illumination Control Off



EXTILL1.

External Illumination Control

External Illumination Parameters

Absolute Maximum		
Maximum voltage on output pin with scanner powered down.	High Value: 6 Volts	This allows a pull-up to be connected to this line provided it does not exceed the current on the next line of this table while operating.
Maximum current driven into pin from external source.	High Value: 5mA	Maximum current limited by series resistor dissipation.
Parameter Values		
Output Low Voltage I _{out} = 500uA	High Value: 0.6 Volts	Internal one-hundred ohm series resistor drop included.
Output Low Voltage I _{out} = 1mA	High Value: 0.7 Volts	
Output Low Voltage I _{out} = 4mA	High Value: 1.0 Volts	
Output Low Voltage I _{out} = 6mA	High Value: 1.2 Volts	
Output High Voltage I _{out} = -500uA	Low Value: 3.6 Volts	
Output High Voltage I _{out} = -1mA	Low Value: 3.5 Volts	
Output High Voltage I _{out} = -4mA	Low Value: 3.3 Volts	
Output High Voltage I _{out} = -6mA	Low Value: 3.1 Volts	

External Illumination Schematic

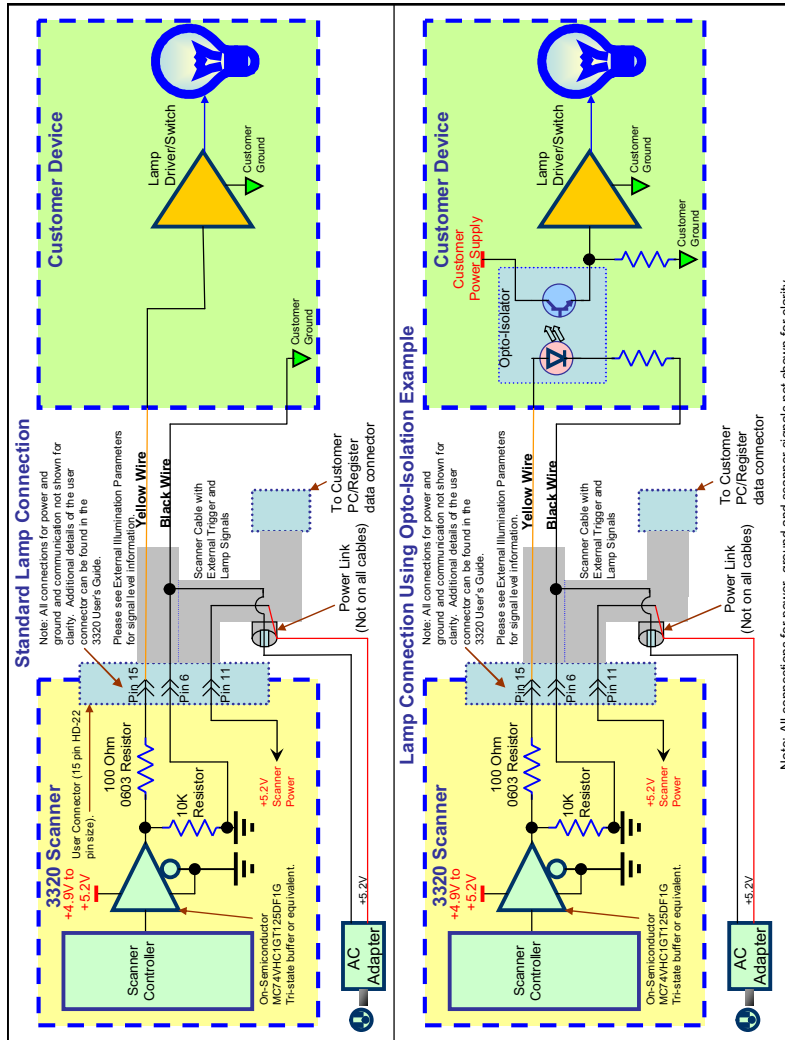

SYMBOLOLOGIES

This programming section contains the following menu selections. Refer to [Chapter 10](#) for settings and defaults.

- All Symbolologies
- Aztec Code
- China Post (Hong Kong 2 of 5)
- Chinese Sensible (Han Xin) Code
- Codabar
- Codablock A
- Codablock F
- Code 11
- Code 128
- Code 32 Pharmaceutical (PARAF)
- Code 39
- Code 93
- Data Matrix
- EAN/JAN-8
- EAN/JAN-13
- GS1 Composite Codes
- GS1 DataBar Expanded
- GS1 DataBar Limited
- GS1 DataBar Omnidirectional
- GS1 Emulation
- GS1-128
- Interleaved 2 of 5
- Korea Post
- Matrix 2 of 5
- MaxiCode
- MicroPDF417
- MSI
- NEC 2 of 5
- Postal Codes - 2D
- Postal Codes - Linear
- PDF417
- QR Code
- Straight 2 of 5 IATA (two-bar start/stop)
- Straight 2 of 5 Industrial (three-bar start/stop)
- TCIF Linked Code 39 (TLC39)
- Telepen
- Trioptic Code
- UPC-A
- UPC-A/EAN-13 with Extended Coupon Code
- UPC-E0
- UPC-E1

All Symbologies

If you want to decode all the symbologies allowable for your scanner, scan the *All Symbologies On* code. If on the other hand, you want to decode only a particular symbology, scan All Symbologies Off followed by the On symbol for that particular symbology.

Note: *Scanner performance may reduce by scanning All Symbologies On. Only scan All Symbologies On when needed.*



ALLEN A1.

All Symbologies On



ALLEN A0.

All Symbologies Off

Note: *When All Symbologies On is scanned, 2D Postal Codes are not enabled. 2D Postal Codes must be enabled separately.*

Message Length Description

You are able to set the valid reading length of some of the barcode symbologies. You may wish to set the same value for minimum and maximum length to force the scanner to read fixed length barcode data. This helps reduce the chances of a misread.

Example: Decode only those barcodes with a count of 9-20 characters.

Min. length = 09

Max. length = 20

Example: Decode only those barcodes with a count of 15 characters.

Min. length = 15

Max. length = 15

For a value other than the minimum and maximum message length defaults, scan the barcodes included in the explanation of the symbology, then scan the digit value of the message length and Save barcodes from the [Programming Chart](#), beginning on page 222. The minimum and maximum lengths and the defaults are included with the respective symbologies.

Codabar

<Default All Codabar Settings>



Codabar On/Off



Codabar Start/Stop Characters

Start/Stop characters identify the leading and trailing ends of the barcode. You may either transmit, or not transmit Start/Stop characters. *Default = Don't Transmit.*



Codabar Check Character

Codabar check characters are created using different “modulos.” You can program the scanner to read only Codabar barcodes with Modulo 16 check characters. *Default = No Check Character.*

No Check Character indicates that the scanner reads and transmits barcode data with or without a check character.

When Check Character is set to *Validate and Transmit*, the scanner will only read Codabar barcodes printed with a check character, and will transmit this character at the end of the scanned data.

When Check Character is set to *Validate, but Don't Transmit*, the unit will only read Codabar barcodes printed *with* a check character, but will not transmit the check character with the scanned data.



CBRCK20.
*** No Check Character**



CBRCK21.
Validate Modulo 16, but Don't Transmit



CBRCK22.
Validate Modulo 16 and Transmit

Codabar Concatenation

Codabar supports symbol concatenation. When you enable concatenation, the scanner looks for a Codabar symbol having a “D” start character, adjacent to a symbol having a “D” stop character. In this case the two messages are concatenated into one with the “D” characters omitted.



Select **Require** to prevent the scanner from decoding a single “D” Codabar symbol without its companion. This selection has no effect on Codabar symbols without Stop/Start D characters.



CBRCCT1.
On



CBRCCT0.
*** Off**



CBRCCT2.
Require

Codabar Message Length

Scan the barcodes below to change the message length. Refer to [Message Length Description](#) on page 94 for additional information. Minimum and Maximum lengths = 2-60. Minimum Default = 4, Maximum Default = 60.



CBRMIN.

Minimum Message Length



CBRMAX.

Maximum Message Length

Code 39

< Default All Code 39 Settings >



C39DFT.

Code 39 On/Off



C39ENA1.

*** On**



C39ENAO.

Off

Code 39 Start/Stop Characters

Start/Stop characters identify the leading and trailing ends of the barcode. You may either transmit, or not transmit Start/Stop characters. *Default = Don't Transmit.*



C39SSX1.

Transmit



C39SSXD.

*** Don't Transmit**

Code 39 Check Character

No Check Character indicates that the scanner reads and transmits barcode data with or without a check character.

When Check Character is set to Validate, but Don't Transmit, the unit only reads Code 39 barcodes printed with a check character, but will not transmit the check character with the scanned data.

When Check Character is set to Validate and Transmit, the scanner only reads Code 39 barcodes printed with a check character, and will transmit this character at the end of the scanned data. *Default = No Check Character.*



C39CK20.

* No Check Character



C39CK21.

Validate, but Don't Transmit



C39CK22.

Validate and Transmit

Code 39 Message Length

Scan the barcodes below to change the message length. Refer to [Message Length Description](#) on page 94 for additional information. Minimum and Maximum lengths = 0-48. Minimum Default = 0, Maximum Default = 48.



C39MIN.

Minimum Message Length



C39MAX.

Maximum Message Length

Code 39 Append

This function allows the scanner to append the data from several Code 39 barcodes together before transmitting them to the host computer. When the scanner encounters a Code 39 barcode with the append trigger character(s), it buffers Code 39 barcodes until it reads a Code 39 barcode that does not have the append trigger. The data is then transmitted in the order in which the barcodes were read (FIFO). *Default = Off.*



C39APP1.

On



C39APP0.

* Off

Code 32 Pharmaceutical (PARAF)

Code 32 Pharmaceutical is a form of the Code 39 symbology used by Italian pharmacies. This symbology is also known as PARAF.

Note: *Trioptic Code (see page [127](#)) must be turned Off while scanning Code 32 Pharmaceutical codes.*



C39B321.

On



C39B320.

* Off

Full ASCII

If Full ASCII Code 39 decoding is enabled, certain character pairs within the barcode symbol will be interpreted as a single character. For example: \$V will be decoded as the ASCII character SYN, and /C will be decoded as the ASCII character #. *Default = Off.*

NUL %U	DLE \$P	SP SPACE	0	0	@ %V	P	P	' %W	p +P
SOH \$A	DC1 \$Q	! /A	1	1	A A	Q Q	a	+A	q +Q
STX \$B	DC2 \$R	" /B	2	2	B B	R R	b +B	r +R	
ETX \$C	DC3 \$S	# /C	3	3	C C	S S	c +C	s +S	
EOT \$D	DC4 \$T	\$ /D	4	4	D D	T T	d +D	t +T	
ENQ \$E	NAK \$U	% /E	5	5	E E	U U	e +E	u +U	
ACK \$F	SYN \$V	& /F	6	6	F F	V V	f +F	v +V	
BEL \$G	ETB \$W	' /G	7	7	G G	W W	g +G	w +W	
BS \$H	CAN \$X	(/H	8	8	H H	X X	h +H	x +X	
HT \$I	EM \$Y) /I	9	9	I I	Y Y	i +I	y +Y	
LF \$J	SUB \$Z	* /J	:	/	J J	Z Z	j +J	z +Z	
VT \$K	ESC %A	+ /K	;	%F	K K	[%K	k +K	{ %P	
FF \$L	FS %B	, /L	<	%G	L L	\ %L	l +L	 %Q	
CR \$M	GS %C	- -	=	%H	M M] %M	m +M	} %R	
SO \$N	RS %D	. .	>	%I	N N	^ %N	n +N	~ %S	
SI \$O	US %E	/ /O	?	%J	O O	_ %O	o +O	DEL %T	

Character pairs /M and /N decode as a minus sign and period respectively.
Character pairs /P through /Y decode as 0 through 9.



C39ASCII1.
Full ASCII On



C39ASCII0.
* Full ASCII Off

Code 39 Code Page

Code pages define the mapping of character codes to characters. If the data received does not display with the proper characters, it may be because the barcode being scanned was created using a code page that is different from the one the host program is expecting. If this is the case, scan the barcode below, select the code page with which the barcodes were created (see [Symbology Charts](#) on page 211), and scan the value and the **Save** barcode from the [Programming Chart](#), beginning on page 222. The data characters should then appear properly.



C39DCP.
Code 39 Code Page

Interleaved 2 of 5

< Default All Interleaved 2 of 5 Settings >



I25DFT.

Interleaved 2 of 5 On/Off



I25ENA1.

* On



I25ENA0.

Off

Check Digit

No Check Digit indicates that the scanner reads and transmits barcode data with or without a check digit.

When Check Digit is set to Validate, but Don't Transmit, the unit only reads Interleaved 2 of 5 barcodes printed with a check digit, but will not transmit the check digit with the scanned data.

When Check Digit is set to Validate and Transmit, the scanner only reads Interleaved 2 of 5 barcodes printed with a check digit, and will transmit this digit at the end of the scanned data. *Default = No Check Digit.*



I25CK20.

*** No Check Digit**



I25CK21.

Validate, but Don't Transmit



I25CK22.

Validate and Transmit

Interleaved 2 of 5 Message Length

Scan the barcodes below to change the message length. Refer to [Message Length Description](#) on page 94 for additional information. Minimum and Maximum lengths = 2-80. Minimum Default = 4, Maximum Default = 80.



I25MIN.

Minimum Message Length



I25MAX.

Maximum Message Length

NEC 2 of 5

< Default All NEC 2 of 5 Settings >



NEC 2 of 5 On/Off



Check Digit

No Check Digit indicates that the scanner reads and transmits barcode data with or without a check digit.

When Check Digit is set to Validate, but Don't Transmit, the unit only reads NEC 2 of 5 barcodes printed with a check digit, but will not transmit the check digit with the scanned data.

When Check Digit is set to Validate and Transmit, the scanner only reads NEC 2 of 5 barcodes printed with a check digit, and will transmit this digit at the end of the scanned data. *Default = No Check Digit.*



NEC 2 of 5 Message Length

Scan the barcodes below to change the message length. Refer to [Message Length Description](#) on page 94 for additional information. Minimum and Maximum lengths = 2-80. Minimum Default = 4, Maximum Default = 80.



N25MIN.

Minimum Message Length



N25MAX.

Maximum Message Length

Code 93

< Default All Code 93 Settings >



C93DFT.

Code 93 On/Off



C93ENA1.

*** On**



C93ENA0.

Off

Code 93 Message Length

Scan the barcodes below to change the message length. Refer to [Message Length Description](#) on page 94 for additional information. Minimum and Maximum lengths = 0-80. Minimum Default = 0, Maximum Default = 80.



C93MIN.

Minimum Message Length



C93MAX.

Maximum Message Length

Code 93 Append

This function allows the scanner to append the data from several Code 93 barcodes together before transmitting them to the host computer. When this function is enabled, the scanner stores those Code 93 barcodes that start with a space (excluding the start and stop symbols), and does not immediately transmit the data. The scanner stores the data in the order in which the barcodes are read, deleting the first space from each. The scanner transmits the appended data when it reads a Code 93 barcode that starts with a character other than a space. *Default = Off.*



C93APP1.

On



C93APP0.

*** Off**

Code 93 Code Page

Code pages define the mapping of character codes to characters. If the data received does not display with the proper characters, it may be because the barcode being scanned was created using a code page that is different from the one the host program is expecting. If this is the case, scan the barcode below, select the code page with which the barcodes were created (see [Symbology Charts](#) on page 211), and scan the value and the **Save** barcode from the [Programming Chart](#), beginning on page 222. The data characters should then appear properly.



C93DCP.

Code 93 Code Page

Straight 2 of 5 Industrial (three-bar start/stop)

<Default All Straight 2 of 5 Industrial Settings>



Straight 2 of 5 Industrial On/Off



Straight 2 of 5 Industrial Message Length

Scan the barcodes below to change the message length. Refer to [Message Length Description](#) on page 94 for additional information. Minimum and Maximum lengths = 1-48. Minimum Default = 4, Maximum Default = 48.



Straight 2 of 5 IATA (two-bar start/stop)

<Default All Straight 2 of 5 IATA Settings>



Straight 2 of 5 IATA On/Off



Straight 2 of 5 IATA Message Length

Scan the barcodes below to change the message length. Refer to [Message Length Description](#) on page 94 for additional information. Minimum and Maximum lengths = 1-48. Minimum Default = 4, Maximum Default = 48.



Matrix 2 of 5

<Default All Matrix 2 of 5 Settings>



Matrix 2 of 5 On/Off



Matrix 2 of 5 Message Length

Scan the barcodes below to change the message length. Refer to [Message Length Description](#) on page 94 for additional information. Minimum and Maximum lengths = 1-80. Minimum Default = 4, Maximum Default = 80.



Code 11

<Default All Code 11 Settings>



Code 11 On/Off



Check Digits Required

This option sets whether 1 or 2 check digits are required with Code 11 barcodes.
Default = Two Check Digits.



Code 11 Message Length

Scan the barcodes below to change the message length. Refer to [Message Length Description](#) on page 94 for additional information. Minimum and Maximum lengths = 1-80. Minimum Default = 4, Maximum Default = 80.



Code 128

<Default All Code 128 Settings>



Code 128 On/Off



ISBT 128 Concatenation

In 1994 the International Society of Blood Transfusion (ISBT) ratified a standard for communicating critical blood information in a uniform manner. The use of ISBT formats requires a paid license. The ISBT 128 Application Specification describes 1) the critical data elements for labeling blood products, 2) the current recommendation to use Code 128 due to its high degree of security and its space-efficient design, 3) a variation of Code 128 that supports concatenation of neighboring symbols, and 4) the standard layout for barcodes on a blood product label. Use the barcodes below to turn concatenation On or Off. *Default = Off.*



Code 128 Message Length

Scan the barcodes below to change the message length. Refer to [Message Length Description](#) on page 94 for additional information. Minimum and Maximum lengths = 0-80. Minimum Default = 0, Maximum Default = 80.





Code 128 Append

This function allows the scanner to append the data from several Code 128 barcodes together before transmitting them to the host computer. When the scanner encounters a Code 128 barcode with the append trigger character(s), it buffers Code 128 barcodes until it reads a Code 128 barcode that does not have the append trigger. The data is then transmitted in the order in which the barcodes were read (FIFO). *Default = On.*



Code 128 Code Page

Code pages define the mapping of character codes to characters. If the data received does not display with the proper characters, it may be because the barcode being scanned was created using a code page that is different from the one the host program is expecting. If this is the case, scan the barcode below, select the code page with which the barcodes were created (see [Symbology Charts](#) on page 211), and scan the value and the **Save** barcode from the [Programming Chart](#), beginning on page 222. The data characters should then appear properly.



GS1-128

<Default All GS1-128 Settings>



GS1-128 On/Off



GS1-128 Message Length

Scan the barcodes below to change the message length. Refer to [Message Length Description](#) on page 94 for additional information. Minimum and Maximum lengths = 1-80. Minimum Default = 1, Maximum Default = 80.



Minimum Message Length



Maximum Message Length

Telepen

<Default All Telepen Settings>



Telepen On/Off



Telepen Output

Using AIM Telepen Output, the scanner reads symbols with start/stop pattern 1 and decodes them as standard full ASCII (start/stop pattern 1). When Original Telepen Output is selected, the scanner reads symbols with start/stop pattern 1 and decodes them as compressed numeric with optional full ASCII (start/stop pattern 2). *Default = AIM Telepen Output.*



Telepen Message Length

Scan the barcodes below to change the message length. Refer to [Message Length Description](#) on page 94 for additional information. Minimum and Maximum lengths = 1-60. Minimum Default = 1, Maximum Default = 60.





UPC-A

<Default All UPC-A Settings>



UPC-A On/Off



Note: To convert UPC-A barcodes to EAN-13, see [Convert UPC-A to EAN-13](#) on page 120.

UPC-A Check Digit

This selection allows you to specify whether the check digit should be transmitted at the end of the scanned data or not. *Default = On.*



UPC-A Number System

The numeric system digit of a U.P.C. symbol is normally transmitted at the beginning of the scanned data, but the unit can be programmed so it will not transmit it. *Default = On.*



UPC-A Addenda

This selection adds 2 or 5 digits to the end of all scanned UPC-A data. *Default = Off for both 2 Digit and 5 Digit Addenda.*



UPC-A Addenda Required

When *Required* is scanned, the scanner will only read UPC-A barcodes that have addenda. You must then turn On a 2 or 5 digit addenda listed on [page 115](#). *Default = Not Required.*





UPAARQ0.

*** Not Required**

UPC-A Addenda Separator

When this feature is On, there is a space between the data from the barcode and the data from the addenda. When turned Off, there is no space. *Default = On.*



UPAADS1.

*** On**



UPAADS0.

Off

UPC-A/EAN-13 with Extended Coupon Code

Use the following codes to enable or disable UPC-A and EAN-13 with Extended Coupon Code. When left on the default setting (Off), the scanner treats Coupon Codes and Extended Coupon Codes as single barcodes.

If you scan the Allow Concatenation code, when the scanner sees the coupon code and the extended coupon code in a single scan, it transmits both as one symbology. Otherwise, it transmits the first coupon code it reads.

If you scan the Require Concatenation code, the scanner must see and read the coupon code and extended coupon code in a single read to transmit the data. No data is output unless both codes are read. *Default = Off.*



CPNENA0.

*** Off**



CPNENA1.

Allow Concatenation



CPNENA2.

Require Concatenation

Coupon GS1 DataBar Output

If you scan coupons that have both UPC and GS1 DataBarcodes, you may wish to scan and output only the data from the GS1 DataBarcode. Scan the GS1 Output On code below to scan and output only the GS1 DataBarcode data. *Default = GS1 Output Off.*



CPNGS10.
* **GS1 Output Off**



CPNGS11.
GS1 Output On

UPC-E0

<Default All UPC-E Settings>



UPEDFT.

UPC-E0 On/Off

Most U.P.C. barcodes lead with the 0 number system. To read these codes, use the UPC-E0 On selection. If you need to read codes that lead with the 1 number system, use [UPC-E1](#) on page 119. *Default = On.*



UPEEND1.
* **UPC-E0 On**



UPEEND0.
UPC-E0 Off

UPC-E0 Expand

UPC-E Expand expands the UPC-E code to the 12 digit, UPC-A format. *Default = Off.*



UPEEXP1.
On



UPC-E0 Addenda Required

When Required is scanned, the scanner will only read UPC-E barcodes that have addenda. *Default = Not Required.*



UPC-E0 Addenda Separator

When this feature is On, there is a space between the data from the barcode and the data from the addenda. When turned Off, there is no space. *Default = On.*



UPC-E0 Check Digit

Check Digit specifies whether the check digit should be transmitted at the end of the scanned data or not. *Default = On.*



UPC-E0 Leading Zero

This feature allows the transmission of a leading zero (0) at the beginning of scanned data. To prevent transmission, scan Off. *Default = On.*



UPENSX1.

*** On**



UPENSX0.

Off

UPC-E0 Addenda

This selection adds 2 or 5 digits to the end of all scanned UPC-E data. *Default = Off for both 2 Digit and 5 Digit Addenda.*



UPEAD21.

2 Digit Addenda On



UPEAD20.

*** 2 Digit Addenda Off**



UPEAD51.

5 Digit Addenda On



UPEAD50.

*** 5 Digit Addenda Off**

UPC-E1

Most U.P.C. barcodes lead with the 0 number system. For these codes, use [UPC-E0](#) on page 117. If you need to read codes that lead with the 1 number system, use the UPC-E1 On selection. *Default = Off.*



UPEEN11.

UPC-E1 On



EAN/JAN-13

<Default All EAN/JAN Settings>



EAN/JAN-13 On/Off



Convert UPC-A to EAN-13

When UPC-A Converted to EAN-13 is selected, UPC-A barcodes are converted to 13 digit EAN-13 codes by adding a zero to the front. When Do not Convert UPC-A is selected, UPC-A codes are read as UPC-A.



EAN/JAN-13 Check Digit

This selection allows you to specify whether the check digit should be transmitted at the end of the scanned data or not. *Default = On.*





EAN/JAN-13 Addenda

This selection adds 2 or 5 digits to the end of all scanned EAN/JAN-13 data.
Default = Off for both 2 Digit and 5 Digit Addenda.



EAN/JAN-13 Addenda Required

When Required is scanned, the scanner will only read EAN/JAN-13 barcodes that have addenda. *Default = Not Required.*



EAN/JAN-13 Addenda Separator

When this feature is On, there is a space between the data from the barcode and the data from the addenda. When turned Off, there is no space. *Default = On.*





Note: If you want to enable or disable EAN13 with Extended Coupon Code, refer to [UPC-A/ EAN-13 with Extended Coupon Code](#) on page 116.

ISBN Translate

When On is scanned, EAN-13 Bookland symbols are translated into their equivalent ISBN number format. *Default = Off.*



EAN/JAN-8

<Default All EAN/JAN-8 Settings>



EAN/JAN-8 On/Off



EAN/JAN-8 Check Digit

This selection allows you to specify whether the check digit should be transmitted at the end of the scanned data or not. *Default = On.*



EABCKX1.

* On



EABCKX0.

Off

EAN/JAN-8 Addenda

This selection adds 2 or 5 digits to the end of all scanned EAN/JAN-8 data. *Default = Off for both 2 Digit and 5 Digit Addenda.*



EABAD21.

2 Digit Addenda On



EABAD20.

* 2 Digit Addenda Off



EABAD51.

5 Digit Addenda On



EABAD50.

* 5 Digit Addenda Off

EAN/JAN-8 Addenda Required

When Required is scanned, the scanner will only read EAN/JAN-8 barcodes that have addenda. *Default = Not Required.*



EABARQ1.

Required



EABARQ0.

* Not Required

EAN/JAN-8 Addenda Separator

When this feature is On, there is a space between the data from the barcode and the data from the addenda. When turned Off, there is no space. *Default = On.*



EABADS1.

* On



EABADS0.

Off

MSI

<Default All MSI Settings>



MSIDFT.

MSI On/Off



MSIENA1.

On



MSIENA0.

* Off

MSI Check Character

Different types of check characters are used with MSI barcodes. You can program the scanner to read MSI barcodes with Type 10 check characters. *Default = Validate Type 10, but Don't Transmit.*

When Check Character is set to Validate Type 10/11 and Transmit, the scanner will only read MSI barcodes printed with the specified type check character(s), and will transmit the character(s) at the end of the scanned data.

When Check Character is set to Validate Type 10/11, but Don't Transmit, the unit will only read MSI barcodes printed with the specified type check character(s), but will not transmit the check character(s) with the scanned data.



MSICHK0.

*** Validate Type 10, but Don't Transmit**



MSICHK1.

Validate Type 10 and Transmit



MSICHK2.

Validate 2 Type 10 Characters, but Don't Transmit



MSICHK3.

Validate 2 Type 10 Characters and Transmit



MSICHK4.

Validate Type 11 then Type 10 Character, but Don't Transmit



MSICHK5.

Validate Type 11 then Type 10 Character and Transmit



MSICHK6.

Disable MSI Check Characters

MSI Message Length

Scan the barcodes below to change the message length. Refer to [Message Length Description](#) on page 94 for additional information. Minimum and Maximum lengths = 4-48. Minimum Default = 4, Maximum Default = 48.



MSIMIN.

Minimum Message Length



MSIMAX.

Maximum Message Length

GS1 DataBar Omnidirectional

< Default All GS1 DataBar Omnidirectional Settings >



GS1 DataBar Omnidirectional On/Off



GS1 DataBar Limited

< Default All GS1 DataBar Limited Settings >



GS1 DataBar Limited On/Off



GS1 DataBar Expanded

< Default All GS1 DataBar Expanded Settings >



GS1 DataBar Expanded On/Off



GS1 DataBar Expanded Message Length

Scan the barcodes below to change the message length. Refer to [Message Length Description](#) on page 94 for additional information. Minimum and Maximum lengths = 4-74. Minimum Default = 4, Maximum Default = 74.



Trioptic Code

Note: If you are going to scan Code 32 Pharmaceutical codes (see page 99), Trioptic Code must be Off.

Trioptic Code is used for labeling magnetic storage media.



Codablock A

<Default All Codablock A Settings>



Codablock A On/Off



Codablock A Message Length

Scan the barcodes below to change the message length. Refer to [Message Length Description](#) on page 94 for additional information. Minimum and Maximum lengths = 1-600. Minimum Default = 1, Maximum Default = 600.



Minimum Message Length



Maximum Message Length

Codablock F

<Default All Codablock F Settings>



Codablock F On/Off



Codablock F Message Length

Scan the barcodes below to change the message length. Refer to [Message Length Description](#) on page 94 for additional information. Minimum and Maximum lengths = 1-2048. Minimum Default = 1, Maximum Default = 2048.



PDF417

< Default All PDF417 Settings >



PDF417 On/Off



PDF417 Message Length

Scan the barcodes below to change the message length. Refer to [Message Length Description](#) on page 94 for additional information. Minimum and Maximum lengths = 1-2750. Minimum Default = 1, Maximum Default = 2750.



MacroPDF417

MacroPDF417 is an implementation of PDF417 capable of encoding very large amounts of data into multiple PDF417 barcodes. When this selection is enabled, these multiple barcodes are assembled into a single data string. *Default = On.*



MicroPDF417

< Default All MicroPDF417 Settings >



MicroPDF417 On/Off



MicroPDF417 Message Length

Scan the barcodes below to change the message length. Refer to [Message Length Description](#) on page 94 for additional information. Minimum and Maximum lengths = 1-366. Minimum Default = 1, Maximum Default = 366.



GS1 Composite Codes

Linear codes are combined with a unique 2D composite component to form a new class called GS1 Composite symbology. GS1 Composite symbologies allow for the co-existence of symbologies already in use. *Default = Off.*



UPC/EAN Version

Scan the *UPC/EAN Version On* barcode to decode GS1 Composite symbols that have a U.P.C. or an EAN linear component. (This does not affect GS1 Composite symbols with a GS1-128 or GS1 linear component.) *Default = UPC/EAN Version Off.*



Note: *If you scan coupons that have both UPC and GS1 DataBarcodes, you may wish to scan and output only the data from the GS1 DataBarcode. See [Coupon GS1 DataBar Output](#) on page 117 for further information.*

GS1 Composite Code Message Length

Scan the barcodes below to change the message length. Refer to [Message Length Description](#) on page 94 for additional information. Minimum and Maximum lengths = 1-2435. Minimum Default = 1, Maximum Default = 2435.



GS1 Emulation

The scanner can automatically format the output from any GS1 data carrier to emulate what would be encoded in an equivalent GS1-128 or GS1 DataBar symbol. GS1 data carriers include UPC-A and UPC-E, EAN-13 and EAN-8, ITF-14, GS1-128, and GS1-128 DataBar and GS1 Composites. (Any application that accepts GS1 data can be simplified since it only needs to recognize one data carrier type.)

If GS1-128 Emulation is scanned, all retail codes (U.P.C., UPC-E, EAN8, EAN13) are expanded out to 16 digits. If the AIM ID is enabled, the value will be the GS1-128 AIM ID,]C1 (see [Symbology Charts](#) on page 211).

If GS1 DataBar Emulation is scanned, all retail codes (U.P.C., UPC-E, EAN8, EAN13) are expanded out to 16 digits. If the AIM ID is enabled, the value will be the GS1-DataBar AIM ID,]em (see [Symbology Charts](#) on page 211).

If GS1 Code Expansion Off is scanned, retail code expansion is disabled, and UPC-E expansion is controlled by the [UPC-E0 Expand](#) (see page 117) setting. If the AIM ID is enabled, the value will be the GS1-128 AIM ID,]C1 (see [Symbology Charts](#) on page 211).

If EAN8 to EAN13 Conversion is scanned, all EAN8 barcodes are converted to EAN13 format.

Default = GS1 Emulation Off.



EANEMU1.
GS1-128 Emulation



EANEMU2.
GS1 DataBar Emulation



EANEMU3.
GS1 Code Expansion Off



EANEMU4.
EAN8 to EAN13 Conversion



EANEMU0.
*** GS1 Emulation Off**

TCIF Linked Code 39 (TLC39)

This code is a composite code since it has a Code 39 linear component and a MicroPDF417 stacked code component. All barcode readers are capable of reading the Code 39 linear component. The MicroPDF417 component can only be decoded if TLC39 On is selected. The linear component may be decoded as Code 39 even if TLC39 is Off. *Default = Off.*



T39ENA1.
On



T39ENA0.
*** Off**

QR Code

< Default All QR Code Settings >



QR Code On/Off

This selection applies to both QR Code and Micro QR Code.



QR Code Message Length

Scan the barcodes below to change the message length. Refer to [Message Length Description](#) on page 94 for additional information. Minimum and Maximum lengths = 1-7089. Minimum Default = 1, Maximum Default = 7089.



QR Code Append

This function allows the scanner to append the data from several QR Code barcodes together before transmitting them to the host computer. When the scanner encounters an QR Code barcode with the append trigger character(s), it buffers the number of QR Code barcodes determined by information encoded in those barcodes. Once the proper number of codes is reached, the data is output in the order specified in the barcodes. *Default = On.*





QR Code Page

QR Code pages define the mapping of character codes to characters. If the data received does not display with the proper characters, it may be because the barcode being scanned was created using a code page that is different from the one the host program is expecting. If this is the case, scan the barcode below, select the code page with which the barcodes were created (see [Symbology Charts](#) on page 211), and scan the value and the **Save** barcode from the [Programming Chart](#), beginning on page 222. The data characters should then appear properly.



Data Matrix

< Default All Data Matrix Settings >



Data Matrix On/Off



Data Matrix Message Length

Scan the barcodes below to change the message length. Refer to [Message Length Description](#) on page 94 for additional information. Minimum and Maximum lengths = 1-3116. Minimum Default = 1, Maximum Default = 3116.



IDMMIN.

Minimum Message Length



IDMMAX.

Maximum Message Length

Data Matrix Code Page

Data Matrix Code pages define the mapping of character codes to characters. If the data received does not display with the proper characters, it may be because the barcode being scanned was created using a code page that is different from the one the host program is expecting. If this is the case, scan the barcode below, select the code page with which the barcodes were created (see [Symbology Charts](#) on page 211), and scan the value and the **Save** barcode from the [Programming Chart](#), beginning on page 222. The data characters should then appear properly.



IDMDCP.

Data Matrix Code Page

MaxiCode

< Default All MaxiCode Settings >



MaxiCode On/Off



MaxiCode Message Length

Scan the barcodes below to change the message length. Refer to [Message Length Description](#) on page 94 for additional information. Minimum and Maximum lengths = 1-150. Minimum Default = 1, Maximum Default = 150.



Aztec Code

< Default All Aztec Code Settings >



Aztec Code On/Off



Aztec Code Message Length

Scan the barcodes below to change the message length. Refer to [Message Length Description](#) on page 94 for additional information. Minimum and Maximum lengths = 1-3832. Minimum Default = 1, Maximum Default = 3832.



Aztec Append

This function allows the scanner to append the data from several Aztec barcodes together before transmitting them to the host computer. When the scanner encounters an Aztec barcode with the append trigger character(s), it buffers the number of Aztec barcodes determined by information encoded in those barcodes. Once the proper number of codes is reached, the data is output in the order specified in the barcodes. *Default = On.*





Aztec Code Page

Aztec Code pages define the mapping of character codes to characters. If the data received does not display with the proper characters, it may be because the barcode being scanned was created using a code page that is different from the one the host program is expecting. If this is the case, scan the barcode below, select the code page with which the barcodes were created (see [Symbology Charts](#) on page 211), and scan the value and the **Save** barcode from the [Programming Chart](#), beginning on page 222. The data characters should then appear properly.



Chinese Sensible (Han Xin) Code

< Default All Han Xin Settings >



Han Xin Code On/Off



Han Xin Code Message Length

Scan the barcodes below to change the message length. Refer to [Message Length Description](#) on page 94 for additional information. Minimum and Maximum lengths = 1-7833. Minimum Default = 1, Maximum Default = 7833.





Postal Codes - 2D

The following lists the possible 2D postal codes, and 2D postal code combinations that are allowed. Only one 2D postal code selection can be active at a time. If you scan a second 2D postal code selection, the first selection is overwritten. *Default = 2D Postal Codes Off.*



Single 2D Postal Codes:



POSTAL1.
Australian Post On



POSTAL30.
Canadian Post On



POSTAL3.
Japanese Post On



POSTAL5.
Planet Code On
Also see [Planet](#)



POSTAL6.
Postnet On
Also see [Postnet](#)



POSTAL7.
British Post On



POSTAL10.
Intelligent Mail Barcode On



POSTAL4.
KIX Post On



POSTAL9.
Postal-4i On



POSTAL11.
Postnet with B and B' Fields On



POSTAL2.
InfoMail On

Combination 2D Postal Codes:



POSTAL8.

**InfoMail and British
Post On**



POSTAL14.

**Postnet and
Postal-4i On**



POSTAL17.

**Postal-4i and
Intelligent Mail Barcode On**



POSTAL12.

**Planet Code and
Postnet On**



POSTAL13.

**Planet Code and
Postal-4i On**



POSTAL20.

**Intelligent Mail Barcode and
Postnet with B and B' Fields On**



POSTAL16.

**Postnet and
Intelligent Mail Barcode On**



POSTAL19.

**Postal-4i and
Postnet with B and B' Fields On**



POSTAL18.

**Planet Code and
Postnet with B and B' Fields On**



POSTAL15.

**Planet Code and
Intelligent Mail Barcode**



POSTAL21.
Planet Code,
Postnet, and
Postal-4i On



POSTAL22.
Planet Code,
Postnet, and
Intelligent Mail Barcode On



POSTAL23.
Planet Code,
Postal-4i, and
Intelligent Mail Barcode On



POSTAL24.
Postnet,
Postal-4i, and
Intelligent Mail Barcode On



POSTAL25.
Planet Code,
Postal-4i, and
Postnet with B and B' Fields On



POSTAL26.
Planet Code,
Intelligent Mail Barcode, and
Postnet with B and B' Fields On



POSTAL27.
Postal-4i,
Intelligent Mail Barcode, and
Postnet with B and B' Fields On



POSTAL28.
Planet Code,
Postal-4i,
Intelligent Mail Barcode, and
Postnet On



POSTAL29.
Planet Code,
Postal-4i,
Intelligent Mail Barcode, and
Postnet with B and B' Fields On

Planet Code Check Digit

This selection allows you to specify whether the check digit should be transmitted at the end of Planet Code data. *Default = Don't Transmit.*



PLNCKX1.

Transmit Check Digit



PLNCKX0.

*** Don't Transmit Check Digit**

Postnet Check Digit

This selection allows you to specify whether the check digit should be transmitted at the end of Postnet data. *Default = Don't Transmit.*



NETCKX1.

Transmit Check Digit



NETCKX0.

*** Don't Transmit Check Digit**

Australian Post Interpretation

This option controls what interpretation is applied to customer fields in Australian 4-State symbols.

Bar Output lists the bar patterns in "0123" format.

Numeric N Table causes that field to be interpreted as numeric data using the N Table.

Alphanumeric C Table causes the field to be interpreted as alphanumeric data using the C Table. Refer to the Australian Post Specification Tables.

Combination C and N Tables causes the field to be interpreted using either the C or N Tables.



AUSINT0.

*** Bar Output**



AUSINT2.

Alphanumeric C Table



AUSINT1.

Numeric N Table



AUSINT3.

Combination C and N Tables

Postal Codes - Linear

The following lists linear postal codes. Any combination of linear postal code selections can be active at a time.

China Post (Hong Kong 2 of 5)

<Default All China Post (Hong Kong 2 of 5) Settings>



CPCDFT.

China Post (Hong Kong 2 of 5) On/Off



CPCENA1.

On



CPCENA0.

*** Off**

China Post (Hong Kong 2 of 5) Message Length

Scan the barcodes below to change the message length. Refer to [Message Length Description](#) on page 94 for additional information. Minimum and Maximum lengths = 2-80. Minimum Default = 4, Maximum Default = 80.



CFCMIN.

Minimum Message Length



CFCMAX.

Maximum Message Length

Korea Post

<Default All Korea Post Settings>



KPCDFT.

Korea Post



KPCENA1.

On



KPCENA0.

*** Off**

Korea Post Message Length

Scan the barcodes below to change the message length. Refer to [Message Length Description](#) on page 94 for additional information. Minimum and Maximum lengths = 2-80. Minimum Default = 4, Maximum Default = 48.



KPCMIN.

Minimum Message Length



KPCMAX.

Maximum Message Length

Korea Post Check Digit

This selection allows you to specify whether the check digit should be transmitted.
Default = Don't Transmit.



KPCCHK1.

Transmit Check Digit



KPCCHK0.

*** Don't Transmit Check Digit**

IMAGING COMMANDS

The scanner is like a digital camera in the way it captures, manipulates, and transfers images. The following commands allow you to alter the way the scanner performs these functions.

Single-Use Basis

Imaging Commands with their modifiers send instructions to the scanner on a single-use basis, and take effect for a single image capture. Once that capture is complete, the scanner reverts to its imaging default settings. If you want to permanently change a setting, you must use the serial default commands (see [Serial Programming Commands](#) on page 175). When the serial default command is used, that selection becomes the new, permanent setting for the scanner.

Command Syntax

Multiple modifiers and commands can be issued within one sequence. If additional modifiers are to be applied to the same command, just add the modifiers to that command. For example, to add 2 modifiers to the Image Snap command, such as setting the Imaging Style to 1P and the Wait for Trigger to 1T, you would enter `IMG SNP1P1T`.

Note: *After processing an image capture command (IMG SNP or IMG BOX), you must follow it with an IMG SHP command if you want to see it on your terminal.*

To add a command to a sequence, each new command is separated with a semicolon. For example, to add the Image Ship command to the above sequence, you would enter `IMG SNP1P1T;IMG SHP`.

The imaging commands are:

[Image Snap - IMG SNP](#) (page 150)

[Image Ship - IMG SHP](#) (page 153)

[Intelligent Signature Capture - IMG BOX](#) (page 162)

The modifiers for each of these commands follow the command description.

Note: *The images included with each command description are examples only. The results you achieve may be different from those included in this manual. The quality of the output you receive will vary depending on lighting, quality of the initial image/object being captured, and distance of the scanner from the image/object. To achieve a high quality image, it is recommended that you position your scanner 4-6" (10.2-15.2 cm) away from the image/object you are capturing.*

Step 1 - Take a Picture Using IMGSNP

Image Snap - IMGSNP

An image is taken whenever the hardware button is pushed, or when the Image Snap (IMGSNP) command is processed.

The image snap command has many different modifiers that can be used to change the look of the image in memory. Any number of modifiers may be appended to the IMGSNP command. For example, you can use the following command to snap an image, increase the gain, and have the beeper sound once the snap is complete: IMGSNP2G1B

IMGSNP Modifiers

P - Imaging Style

This sets the Image Snap style.

- 0P Decoding Style. This processing allows a few frames to be taken until the exposure parameters are met. The last frame is then available for further use.
- 1P Photo Style (*default*). This mimics a simple digital camera, and results in a visually optimized image.
- 2P Manual Style. This is an advanced style that should only be used by an experienced user. It allows you the most freedom to set up the scanner, and has no auto-exposure.

B - Beeper

Causes a beep to sound after an image is snapped.

- 0B No beep (*default*)
- 1B Sounds a beep when the image is captured.

T - Wait for Trigger

Waits for a hardware button push before taking the image. This is only available when using Photo Style (1P).

- 0T Takes image immediately (*default*)
- 1T Waits for a button push, then takes the image

L - LED State

Determines if the LEDs should be On or Off, and when. Ambient illumination (0L) is preferred for taking pictures of color documents, such as ID cards. LED illumination (1L) is preferred when the scanner is handheld. LED State is not available when using Decoding Style (0P).

- 0L LEDs Off (*default*)
- 1L LEDs On

E - Exposure

Exposure is used in Manual Style only (2P), and allows you to set the exposure time. This is similar to setting a shutter speed on a camera. The exposure time determines how long the scanner takes to record an image. On a bright day, exposure times can be very short because plenty of light is available to help record an image. At nighttime, exposure time can increase dramatically due to the near absence of light. Units are 127 microseconds. (*Default = 7874 (Gen 6), 10000000 (Gen 7)*)

- nE Range: 1 - 7874 (Gen 6), 1 - 10000000 (Gen 7)

Note: For more information about the Gen 6 and Gen 7 software revisions, see [About Software Revisions](#) on page 6.

Example of Exposure at 7874E with fluorescent lighting:

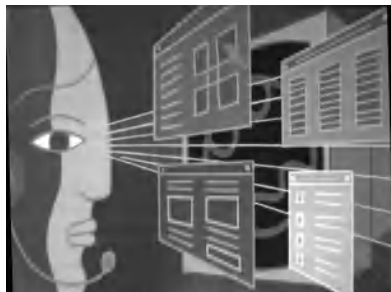

Example of Exposure at 100E with fluorescent lighting:



G - Gain

Gain is used in Manual Style only (2P). Like a volume control, the gain modifier boosts the signal and multiplies the pixel value. As you increase the gain, the noise in an image is also amplified.

1G No gain (*default*)

2G Medium gain

4G Heavy gain

8G Maximum gain

Example of Gain at
1G:



Example of Gain at
4G:



Example of Gain at
8G:



W - Target White Value

Sets the target for the median grayscale value in the captured image. For capturing close-up images of high contrast documents, a lower setting, such as 75, is recommended. Higher settings result in longer exposure times and brighter images, but if the setting is too high, the image may be overexposed. Target White Value is only available when using Photo Style (1P). (*Default = 125*)

nW Range: 0 - 255

Example of White
Value at 75W:



Example of White
Value at 125W:



Example of White
Value at 200W:



D - Delta for Acceptance

This sets the allowable range for the white value setting (see [W - Target White Value](#)). Delta is only available when using Photo Style (1P). (*Default = 25 (Gen 6), 30 (Gen 7)*)

Note: For more information about the Gen 6 and Gen 7 software revisions, see [About Software Revisions](#) on page 6.

nD Range: 0 - 255

U - Update Tries

This sets the maximum number of frames the scanner should take to reach the [D - Delta for Acceptance](#). Update Tries is only available when using Photo Style (1P). (Default = 6)

nU Range: 0 - 10

% - Target Set Point Percentage

Sets the target point for the light and dark values in the captured image. A setting of 75% means 75% of the pixels are at or below the target white value, and 25% of the pixels are above the target white value. Altering this setting from the default is not recommended under normal circumstances. To alter grayscale values, [W - Target White Value](#) should be used. (Default = 50)

n% Range: 1 - 99

Example of Target Set Point Percentage at 97%:

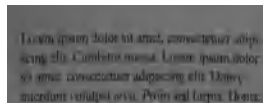

Example of Target Set Point Percentage at 50%:

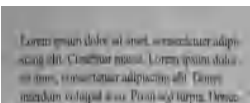

Example of Target Set Point Percentage at 40%:

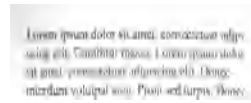

Step 2 - Ship a Picture Using IMGSHIP

Image Ship - IMGSHIP

An image is taken whenever the button is pushed, or when the Image Snap (IMGSNP) command is processed. The last image is always stored in memory. You can “ship” the image by using the IMGSHIP command.

The image ship commands have many different modifiers that can be used to change the look of the image output. Modifiers affect the image that is transmitted, but do not affect the image in memory. Any number of modifiers may be appended to the IMGSHIP command. For example, you can use the following command to snap and ship a bitmap image with gamma correction and document image filtering: `IMGSNP;IMGSHIP8F75K26U`

IMGSHHP Modifiers

A - Infinity Filter

Enhances pictures taken from very long distances (greater than 10 feet or 3m). The Infinity Filter should not be used with [IMGSNP Modifiers](#) (see page 150).

0A Infinity filter Off (*default*)

1A Infinity filter On

**Example of Infinity Filter Off (0A)
from approximately 12 feet
(3.66m) away:**

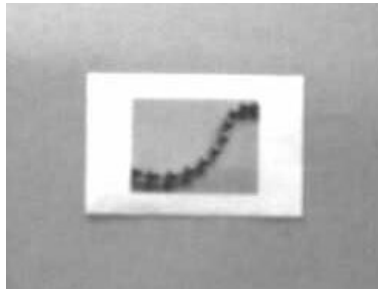

**Example of Infinity Filter on (1A)
from approximately 12 feet (3.66m)
away:**

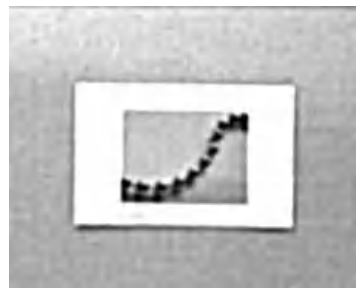

C - Compensation

Flattens the image to account for variations in illumination across the image.

0C Compensation disabled (*default*)

1C Compensation enabled

Example of Compensation at 0C:



Example of Compensation at 1C:



D - Pixel Depth

Indicates the number of bits per pixel in the transmitted image (KIM or BMP format only).

8D 8 bits per pixel, grayscale image (*default*)

1D 1 bit per pixel, black and white image

E - Edge Sharpen

An edge sharpen filter cleans up the edges of an image, making it look cleaner and sharper. While edge sharpening does make the image look cleaner, it also removes some fine detail from the original image. The strength of the edge sharpen filter can be entered from 1 to 24. Entering a 23E gives the sharpest edges, but also increases noise in the image.

0E Don't sharpen image (*default*)

14E Apply edge sharpen for typical image

ne Apply edge sharpen using strength *n* (*n* = 1-24)

Example of Edge Sharpen at 0E:



Example of Edge Sharpen at 24E:



F - File Format

Indicates the desired format for the image.

0F KIM format

1F TIFF binary

2F TIFF binary group 4, compressed

3F TIFF grayscale

4F Uncompressed binary (upper left to lower right, 1 pixel/bit, 0 padded end of line)

5F Uncompressed grayscale (upper left to lower right, bitmap format)

6F JPEG image (*default*)

8F BMP format (lower right to upper left, uncompressed)

H - Histogram Stretch

Increases the contrast of the transmitted image. Not available with some image formats.

0H No stretch (*default*)

1H Histogram stretch

Example of Histogram Stretch at 0H:



Example of Histogram Stretch at 1H:



I - Invert Image

Invert image is used to rotate the image around the X or Y axis.

1ix Invert around the X axis (flips picture upside down)

1iy Invert around the Y axis (flips picture left to right)

Example of image not inverted:



Example of image with Invert Image set to 1ix:



Example of image with Invert Image set to 1iy:



IF- Noise Reduction

Used to reduce the salt and pepper noise in an image.

0if No salt and pepper noise reduction (default)

1if Salt and pepper noise reduction

Example of Noise Reduction Off (0if):



Example of Noise Reduction On (1if):



IR - Image Rotate

0ir Image as snapped (rightside up) (default)

1ir Rotate image 90 degrees to the right

2ir Rotate image 180 degrees (upside down)

3ir Rotate image 90 degrees to the left

Example of Image Rotate set to 0ir:



Example of Image Rotate set to 2ir:



Example of Image Rotate set to 1ir:



Example of Image Rotate set to 3ir:



J - JPEG Image Quality

Sets the desired quality when the JPEG image format is selected. Higher numbers result in higher quality, but larger files. Smaller numbers result in greater amounts of lossy compression, faster transmission times, lower quality, but smaller files.

(Default = 50)

- n J Image is compressed as much as possible while preserving quality factor of n ($n = 0 - 100$)
- 0J Worst quality (smallest file)
- 100J Best quality (largest file)

K - Gamma Correction

Gamma measures the brightness of midtone values produced by the image. You can brighten or darken an image using gamma correction. A higher gamma correction yields an overall brighter image. The lower the setting, the darker the image. The optimal setting for text images is 50K.

- 0K Gamma correction Off (default)
- 50K Apply gamma correction for brightening typical document image
- n K Apply gamma correction factor n ($n = 0-1,000$)

Example of Gamma Correction set to 0K:



Example of Gamma Correction set to 50K:



Example of Gamma Correction set to 255K:



L, R, T, B, M - Image Cropping

Note: *Image Cropping should not be used with [IMGSH modifiers](#) (see page 154).*

Ships a window of the image by specifying the left, right, top, and bottom pixel coordinates. Device columns are numbered 0 through 1279, and device rows are numbered 0 through 959.

nL The left edge of the shipped image corresponds to column n of the image in memory. Range: 000 - 843. (Default = 0)

nR The right edge of the shipped image corresponds to column $n - 1$ of the image in memory. Range: 000 - 843. (Default = all columns)

nT The top edge of the shipped image corresponds to row n of the image in memory. Range: 000 - 639. (Default = 0)

nB The bottom edge of the shipped image corresponds to row $n - 1$ of the image in memory. Range: 000 - 639. (Default = all rows)

Uncropped Image:



Example of Image Crop set to 300R:



Example of Image Crop set to 300L:



Example of Image Crop set to 200B:



Example of Image Crop set to 200T:



Alternately, specify the number of pixels to cut from the outside margin of the image; thus only the center pixels are transmitted.

nM Margin: cut n columns from the left, $n + 1$ columns from the right, n rows from the top, and $n + 1$ rows from the bottom of the image. Ship the remaining center pixels. Range: 0 - 238. (Default = 0, or full image)

Example of Image Crop set to 238M:



P - Protocol

Used for shipping an image. Protocol covers two features of the image data being sent to the host. It addresses the protocol used to send the data (Hmodem, which is an Xmodem 1K variant that has additional header information), and the format of the image data that is sent.

- 0P None (raw data)
- 2P None (*default for USB*)
- 3P Hmodem compressed (*default for RS232*)
- 4P Hmodem

S - Pixel Ship

Pixel Ship sizes an image in proportion to its original size. It decimates the image by shipping only certain, regularly spaced pixels. For example, 4S would transmit every fourth pixel from every fourth line. The smaller number of pixels shipped, the smaller the image, however, after a certain point the image becomes unusable.

- 1S Ship every pixel (*default*)
- 2S Ship every 2nd pixel, both horizontally and vertically
- 3S Ship every 3rd pixel, both horizontally and vertically

Example of Pixel Ship set to 1S:

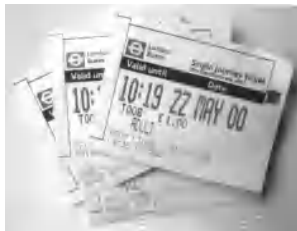

Example of Pixel Ship set to 2S:



Example of Pixel Ship set to 3S:



U - Document Image Filter

Allows you to input parameters to sharpen the edges and smooth the area between the edges of text in an image. This filter should be used with gamma correction (see [page 158](#)), with the scanner in a stand, and the image captured using the command:

IMG SNP1POL168W90%32D

This filter typically provides better JPEG compression than the standard E - Edge Sharpen command (see [page 155](#)). This filter also works well when shipping pure black and white images (1 bit per pixel). The optimal setting is 26U.

- 0U Document image filter Off (*default*)
- 26U Apply document image filter for typical document image
- nU Apply document image filter using grayscale threshold n. Use lower numbers when the image contrast is lower. 1U will have a similar effect to setting [E - Edge Sharpen](#) (see page 155) to 22e. Range: 0-255.

Example of Document Image Filter set to 0U:



Example of Document Image Filter set to 26U:



V - Blur Image

Smooths transitions by averaging the pixels next to the hard edges of defined lines and shaded areas in an image.

- 0V Don't blur (*default*)
- 1V Blur

Example of Blur Image Off (0V):



Example of Blur Image On (1V):



W - Histogram Ship

A histogram gives a quick picture of the tonal range of an image, or key type. A low-key image has detail concentrated in the shadows; a high-key image has detail concentrated in the highlights; and an average-key image has detail concentrated in the midtones. This modifier ships the histogram for an image.

0W Don't ship histogram (*default*)

1W Ship histogram

Image used for histogram:



Histogram of image at left:



Image Size Compatibility

If you have applications that expect an image ship to return exactly 640x480 pixels, scan the Force VGA Resolution barcode. *Default = Native Resolution.*



IMGVGA1.

Force VGA Resolution



IMGVGA0.

*** Native Resolution**

Intelligent Signature Capture - IMGBOX

IMGBOX allows you to configure the size and location of a signature capture area relative to its proximity to a barcode. This allows you to tailor a signature capture area to a specific form. In order to use IMGBOX, you need a set form where the signature box location is in a known location relative to a barcode. You can input the overall size of the signature area, as well as specify how far the signature area is from the barcode, vertically and horizontally. You can also set the resolution and file format for the final output of the signature capture image.

Note: *IMGBOX commands can only be triggered by one of the following types of barcodes: PDF417, Code 39, Code 128, Aztec, Codabar, and Interleaved 2 of 5. Once one of these symbologies has been read, the image is retained for a possible IMGBOX command.*

Signature Capture Optimize

If you will be using your scanner to capture signatures frequently, you should optimize it for this purpose. However, the speed of scanning barcodes may be slowed when this mode is enabled. *Default = Off.*



Below is an example of a signature capture application. In this example, the aimer is centered over the signature capture area and the button is pushed. A single beep is emitted, indicating that the scanner has read a Code 128 barcode and the data has been transferred to the host. An IMGBOX command may now be sent from the host to specify the coordinates of the signature capture area below that code, and indicating that only that area containing the signature should be transferred as an image to the host.

To see this example, align the aimer with the signature area (not with the barcode), then push the button.



Send the following IMGBOX command string after the button push:

Example: IMGBOX245w37h55y.

Note: Case is not important in the command string. It is used here only for clarity.

The following image is captured:



The IMGBOX commands have many different modifiers that can be used to change the size and appearance of the signature image output by the scanner. Modifiers affect the image that is transmitted, but do not affect the image in memory. Any number of modifiers may be appended to the IMGBOX command.

Note: The IMGBOX command will return a NAK unless a window size (width and height) are specified. See [H - Height of Signature Capture Area](#) (page 165) and [W - Width of Signature Capture Area](#) (page 167).

IMGBOX Modifiers

A - Output Image Width

This option is used to size the image horizontally. If using this option, set the resolution (R) to zero.

Example of Image Width set to 200A:

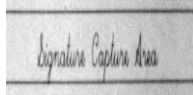

Example of Image Width set to 600A:

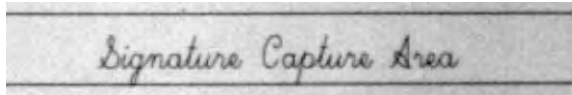

B - Output Image Height

This option is used to size the image vertically. If using this option, set the resolution (R) to zero.

Example of Image Height set to 50B:

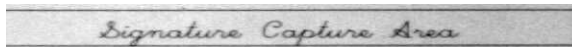

Example of Image Height set to 100B:

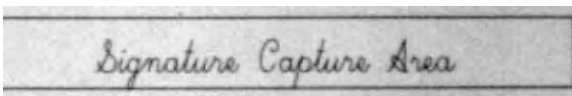

D - Pixel Depth

This indicates the number of bits per pixel in the transmitted image, which defines whether it will be grayscale or black and white.

- 8D 8 bits per pixel, grayscale image (default)
- 1D 1 bit per pixel, black and white image

F - File Format

This option indicates the type of file format in which to save the image.

- 0F KIM format
- 1F TIFF binary
- 2F TIFF binary group 4, compressed
- 3F TIFF grayscale
- 4F Uncompressed Binary
- 5F Uncompressed grayscale
- 6F JPEG image (*default*)
- 7F Outlined image
- 8F BMP format

H - Height of Signature Capture Area

The height of the signature capture area must be measured in inches divided by .01. In the example, the height of the area to be captured is 3/8 inch, resulting in a value of $H = .375/0.01 = 37.5$.

Example: IMGBOX245w37h55y.

K - Gamma Correction

Gamma measures the brightness of midtone values produced by the image. You can brighten or darken an image using gamma correction. A higher gamma correction yields an overall brighter image. The lower the setting, the darker the image. The optimal setting for text images is 50K.

- OK Gamma correction Off (*default*)
- 50K Apply gamma correction for brightening typical document image
- nK Apply gamma correction factor n ($n = 1-255$)

Example of Gamma Correction set to OK:



Example of Gamma Correction set to 50K:



Example of Gamma Correction set to 255K:

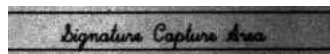

R - Resolution of Signature Capture Area

The resolution is the number of pixels that the scanner outputs per each minimum bar width. The higher the value for R, the higher the quality of the image, but also the larger the file size. Values begin at 1000. The scanner automatically inserts a decimal point between the first and second digit. For example, use 2500 to specify a resolution of 2.5. Set to zero when using the A and B modifiers (see [A - Output Image Width](#) and [B - Output Image Height](#) on page 164).

Example of Resolution set to 0R:

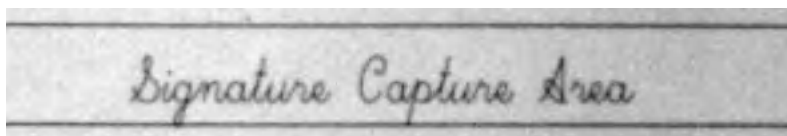

Example of Resolution set to 1000R:

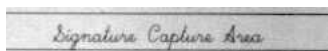

Example of Resolution set to 2000R:

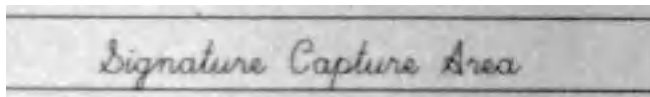

S - Barcode Aspect Ratio

All dimensions used in IMGBOX are measured as multiples of the minimum element size of the barcode. The barcode aspect ratio allows you to set the ratio of the barcode height to the narrow element width. In the example, the narrow element width is .010 inches and the barcode height is 0.400 inches, resulting in a value of $S = 0.4/0.01 = 40$.

W - Width of Signature Capture Area

The width of the signature capture area must be measured in inches divided by .01. In the example, the width of the area to be captured is 2.4 inches, resulting in a value of $W = 2.4/0.01 = 240$. (A value of 245 was used in the example to accommodate a slightly wider image area.)

Example: *IMGBOX245w37h55y*.

X - Horizontal Barcode Offset

The horizontal barcode offset allows you to offset the horizontal center of the signature capture area. Positive values move the horizontal center to the right and negative values to the left. Measurements are in multiples of the minimum bar width.

Example of Horizontal Offset set to 75X:

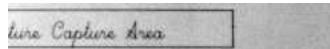

Example of Horizontal Offset set to -75X:

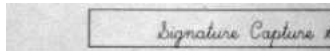

Y - Vertical Barcode Offset

The vertical barcode offset allows you to offset the vertical center of the signature capture area. Negative numbers indicate that the signature capture is above the barcode, and positive numbers indicate that the area is below the barcode. Measurements are in multiples of the minimum bar width.

Example of Vertical Offset set to -7Y:



Example of Vertical Offset set to 65Y:

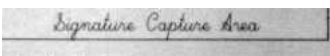

To Add a Test Code I.D. Prefix to All Symbologies

This selection allows you to turn On transmission of a Code I.D. before the decoded symbology. See the [Symbology Charts](#), beginning on page 211) for the single character code that identifies each symbology. This action first clears all current prefixes, then programs a Code I.D. prefix for all symbologies. This is a temporary setting that will be removed when the unit is power cycled.



PRECA2,BK2995C80!

**Add Code I.D. Prefix to
All Symbologies (Temporary)**

Show Decoder Revision

Scan the barcode below to output the decoder revision.

Note: This command is not supported with the Gen 7 software revision. For information about software revisions, see [About Software Revisions](#) on page 6.



REV_DR.

Show Decoder Revision

Show Scan Driver Revision

Scan the barcode below to output the scan driver revision. The scan driver controls image capture.

Note: *This command is not supported with the Gen 7 software revision. For information about software revisions, see [About Software Revisions](#) on page 6.*



Show Software Revision

Scan the barcode below to output the current software revision, unit serial number, and other product information for the scanner.



Show Data Format

Scan the barcode below to show current data format settings.



Test Menu

When you scan the Test Menu On code, then scan a programming code in this manual, the scanner displays the content of a programming code. The programming function will still occur, but in addition, the content of that programming code is output to the terminal.

Note: *This feature should not be used during normal scanner operation.*





TSTMNUO.
* Off

TotalFreedom

TotalFreedom is an open system architecture that makes it possible for you create applications that reside on your scanner. Decoding apps and Data Formatting apps can be created using TotalFreedom. For further information about TotalFreedom, go to our website at sps.honeywell.com.

Application Plug-Ins (Apps)

Any apps that you are using can be turned Off or On by scanning the following barcodes. Apps are stored in groups: Decoding, and Formatting. You can enable and disable these groups of apps by scanning that group's On or Off barcode below. You can also scan the List Apps barcode to output a list of all your apps.



PLGDCE1.
* Decoding Apps On



PLGDCE0.
Decoding Apps Off



PLGFOE1.
* Formatting Apps On



PLGFOE0.
Formatting Apps Off



PLGINF.
List Apps

Note: You must reset your device in order for the apps setting to take effect.

EZConfig for Scanning Introduction

EZConfig for Scanning provides a wide range of PC-based programming functions that can be performed on the scanner connected to your PC. EZConfig for Scanning allows you to download upgrades to the scanner's firmware, change programmed parameters, and create and print programming barcodes. Using EZConfig for Scanning, you can even save/open the programming parameters. This saved file can be e-mailed or, if required, you can create a single barcode that contains all the customized programming parameters and mail or fax that barcode to any location. Users in other locations can scan the barcode to load in the customized programming.

Configure with EZConfig for Scanning

Use the EZConfig for Scanning tool to configure your scanner online:

1. Access the Honeywell Technical Support Downloads Portal at honeywell.com/PSSsoftware-downloads.
2. Go to **Software > Barcode Scanners > Software > Tools and Utilities > EZConfig for Scanning > Current**.

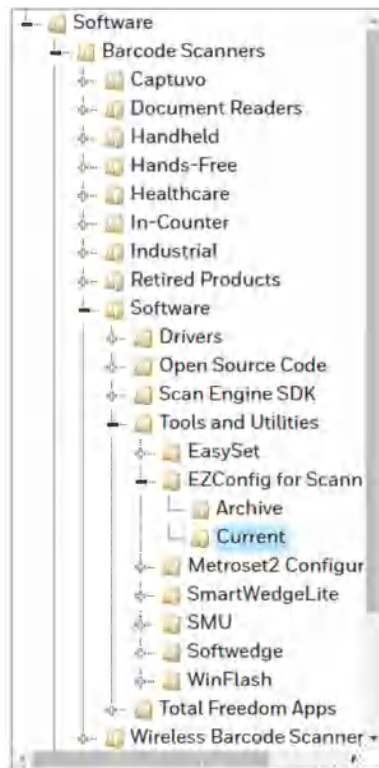

3. Download the **Setup** version of EZConfig for Scanning.
4. Open EZConfig to configure your scanner.

Resetting the Factory Defaults



Caution: *This selection erases all your settings and resets the scanner to the original factory defaults. It also disables all plugins.*

If you aren't sure what programming options are in your scanner, or you've changed some options and want to restore the scanner to factory default settings, first scan the Remove Custom Defaults barcode, then scan Activate Defaults. This resets the scanner to the factory default settings.



DEFOVR.

Remove Custom Defaults



DEFAULT.

Activate Defaults

The [Menu Commands](#), beginning on page 180, list the factory default settings for each of the commands (indicated by an asterisk (*) on the programming pages).

SERIAL PROGRAMMING COMMANDS

The serial programming commands can be used in place of the programming barcodes. Both the serial commands and the programming barcodes will program the scanner. For complete descriptions and examples of each serial programming command, refer to the corresponding programming barcode in this manual.

The device must be set to an RS232 interface (see [page 8](#)). The following commands can be sent via a PC COM port using terminal emulation software.

Conventions

The following conventions are used for menu and query command descriptions:

<i>parameter</i>	A label representing the actual value you should send as part of a command.
[<i>option</i>]	An optional part of a command.
{Data}	Alternatives in a command.
bold	Names of menus, menu commands, buttons, dialog boxes, and windows that appear on the screen.

Menu Command Syntax

Menu commands have the following syntax (spaces have been used for clarity only):

Prefix [:Name:] Tag SubTag {Data} [, SubTag {Data}] [: Tag SubTag {Data}] [...] Storage

Prefix Three ASCII characters: SYN M CR (ASCII 22,77,13).

:Name: This command is only used with cordless devices. It is used to specify whether you're communicating with the base or the scanner. To send information to the scanner (with the base connected to host), use :Xenon: The default factory setting for a Xenon scanner is Xenon

scanner. This setting is changed by using the BT_NAM command, which accepts alphanumeric values. If the name is not known, a wild-card (*) can be used :*

Note: *Since the base stores all work group settings and transfers to them to scanner once they are linked, changes are typically done to the base and not to the scanner.*

Tag	A 3 character case-insensitive field that identifies the desired menu command group. For example, all RS232 configuration settings are identified with a Tag of 232 .
SubTag	A 3 character case-insensitive field that identifies the desired menu command within the tag group. For example, the SubTag for the RS232 baud rate is BAD .
Data	The new value for a menu setting, identified by the Tag and SubTag.
Storage	A single character that specifies the storage table to which the command is applied. An exclamation point (!) performs the command's operation on the device's volatile menu configuration table. A period (.) performs the command's operation on the device's non-volatile menu configuration table. Use the non-volatile table only for semi-permanent changes you want saved through a power cycle.

Query Commands

Several special characters can be used to query the device about its settings.

^	What is the default value for the setting(s).
?	What is the device's current value for the setting(s).
*	What is the range of possible values for the setting(s). (The device's response uses a dash (-) to indicate a continuous range of values. A pipe () separates items in a list of non-continuous values.)

:Name: Field Usage (Optional)

This command returns the query information from the scanner.

Tag Field Usage

When a query is used in place of a Tag field, the query applies to the *entire* set of commands available for the particular storage table indicated by the Storage field of the command. In this case, the SubTag and Data fields should not be used because they are ignored by the device.

SubTag Field Usage

When a query is used in place of a SubTag field, the query applies only to the subset of commands available that match the Tag field. In this case, the Data field should not be used because it is ignored by the device.

Data Field Usage

When a query is used in place of the Data field, the query applies only to the specific command identified by the Tag and SubTag fields.

Concatenation of Multiple Commands

Multiple commands can be issued within one Prefix/Storage sequence. Only the Tag, SubTag, and Data fields must be repeated for each command in the sequence. If additional commands are to be applied to the same Tag, then the new command sequence is separated with a comma (,) and only the SubTag and Data fields of the additional command are issued. If the additional command requires a different Tag field, the command is separated from previous commands by a semicolon (;).

Responses

The device responds to serial commands with one of three responses:

- ACK** Indicates a good command which has been processed.
- ENQ** Indicates an invalid Tag or SubTag command.
- NAK** Indicates the command was good, but the Data field entry was out of the allowable range for this Tag and SubTag combination, e.g., an entry for a minimum message length of 100 when the field will only accept 2 characters.

When responding, the device echoes back the command sequence with the status character inserted directly before each of the punctuation marks (the period, exclamation point, comma, or semicolon) in the command.

Examples of Query Commands

In the following examples, a bracketed notation [] depicts a non-displayable response.

Example: What is the range of possible values for Codabar Coding Enable?

Enter: **cbrena*.**

Response: **CBRENA0-1[ACK]**

This response indicates that Codabar Coding Enable (CBRENA) has a range of values from 0 to 1 (Off and On).

Example: What is the default value for Codabar Coding Enable?

Enter: **cbrena^.**

Response: **CBRENA1[ACK]**

This response indicates that the default setting for Codabar Coding Enable (CBRENA) is 1, or On.

Example: What is the device's current setting for Codabar Coding Enable?

Enter: **cbrena?.**

Response: **CBRENA1[ACK]**

This response indicates that the device's Codabar Coding Enable (CBRENA) is set to 1, or On.

Example: What are the device's settings for all Codabar selections?

Enter: **cbr?.**

Response: **CBRENA1[ACK],
SSX0[ACK],
CK20[ACK],
CCT1[ACK],
MIN2[ACK],
MAX60[ACK],
DFT[ACK].**

This response indicates that the device's Codabar Coding Enable (CBRENA) is set to 1, or On;
the Start/Stop Character (SSX) is set to 0, or Don't Transmit;
the Check Character (CK2) is set to 0, or Not Required;
concatenation (CCT) is set to 1, or Enabled;
the Minimum Message Length (MIN) is set to 2 characters;
the Maximum Message Length (MAX) is set to 60 characters;
and the Default setting (DFT) has no value.

Trigger Commands

You can activate and deactivate the scanner with serial trigger commands. First, the scanner must be put in Manual Trigger Mode by scanning a Manual Trigger Mode barcode (see [Manual Trigger Modes](#) on page 37), or by sending a serial menu command for triggering (see [Serial Trigger Mode](#) on page 185). Once the scanner is in serial trigger mode, the trigger is activated and deactivated by sending the following commands:

Activate: **SYN T CR**

Deactivate: **SYN U CR**

The scanner scans until a barcode has been read, until the deactivate command is sent, or until the serial time-out has been reached (see [Read Time-Out](#) on page 40 for a description, and the serial command on [page 185](#)).

Resetting the Custom Defaults

If you want the custom default settings restored to your scanner, scan the **Activate Custom Defaults** barcode below. This resets the scanner to the custom default settings. If there are no custom defaults, it will reset the scanner to the factory default settings. Any settings that have not been specified through the custom defaults will be defaulted to the factory default settings.



DEFAULT.

Activate Custom Defaults

The charts on the following pages list the factory default settings for each of the commands (indicated by an asterisk (*) on the programming pages).

Menu Commands

Selection	Setting * Indicates default	Serial Command # Indicates a numeric entry	Page
Product Default Settings			
Setting Custom Defaults	Set Custom Defaults	MNUCDF	5
	Save Custom Defaults	MNUCDS	5
Resetting the Custom Defaults	Activate Custom Defaults	DEFAULT	6
Programming the Interface			
Plug and Play Codes	Keyboard Wedge: IBM PC AT and Compatibles with CR suffix	PAP_AT	7
	Laptop Direct Connect with CR suffix	PAPLTD	8
	RS232 Serial Port	PAP232	8
Plug and Play Codes: IBM SurePos	USB IBM SurePos Handheld	PAPSPH	8
	USB IBM SurePos Tabletop	PAPSPT	8
Plug and Play Codes: USB	USB Keyboard (PC)	PAP124	9
	USB Keyboard (Mac)	PAP125	9
	USB Japanese Keyboard (PC)	TRMUSB134	9
	USB HID	PAP131	9
	USB Serial	TRMUSB130	10
	CTS/RTS Emulation On	USBCTS1	10
	CTS/RTS Emulation Off*	USBCTS0	10
	ACK/NAK Mode On	USBACK1	10
	*ACK/NAK Mode Off	USBACK0	10
Remote MasterMind for USB	ReM Off	REMIFC0	10
	*ReM On	ReMIFC1	10
Plug and Play Codes	Verifone Ruby Terminal	PAPRBY	11
	Gilbarco Terminal	PAPGLB	11
	Honeywell Bioptic Aux Port	PAPBIO	11
	Datalogic Magellan Aux Port	PAPMAG	12
	NCR Bioptic Aux Port	PAPNCR	12
	Wincor Nixdorf Terminal	PAPWNX	13
	Wincor Nixdorf Beetle	PAPBTL	13
Program Keyboard Country	*U.S.A.	KBDCTY0	14
	Albania	KBDCTY35	14
	Azeri (Cyrillic)	KBDCTY81	14
	Azeri (Latin)	KBDCTY80	14
	Belarus	KBDCTY82	14

Selection	Setting * Indicates default	Serial Command # Indicates a numeric entry	Page
	Belgium	KBDCTY1	14
	Bosnia	KBDCTY33	14
	Brazil	KBDCTY16	14
	Brazil (MS)	KBDCTY59	14
	Bulgaria (Cyrillic)	KBDCTY52	15
	Bulgaria (Latin)	KBDCTY53	15
	Canada (French legacy)	KBDCTY54	15
	Canada (French)	KBDCTY18	15
	Canada (Multilingual)	KBDCTY55	15
	Croatia	KBDCTY32	15
	Czech	KBDCTY15	15
	Czech (Programmers)	KBDCTY40	15
	Czech (QWERTY)	KBDCTY39	15
	Czech (QWERTZ)	KBDCTY38	15
	Denmark	KBDCTY8	15
	Dutch (Netherlands)	KBDCTY11	15
	Estonia	KBDCTY41	16
	Faeroese	KBDCTY83	16
	Finland	KBDCTY2	16
	France	KBDCTY3	16
	Gaelic	KBDCTY84	16
	Germany	KBDCTY4	16
	Greek	KBDCTY17	16
	Greek (220 Latin)	KBDCTY64	16
	Greek (220)	KBDCTY61	16
	Greek (319 Latin)	KBDCTY65	16
	Greek (319)	KBDCTY62	16
	Greek (Latin)	KBDCTY63	16
	Greek (MS)	KBDCTY66	17
	Greek (Polytonic)	KBDCTY60	17
	Hebrew	KBDCTY12	17
	Hungarian (101 key)	KBDCTY50	17
	Hungary	KBDCTY19	17
	Iceland	KBDCTY75	17
	Irish	KBDCTY73	17
	Italian (142)	KBDCTY56	17
	Italy	KBDCTY5	17

Selection	Setting * Indicates default	Serial Command # Indicates a numeric entry	Page
	Japan ASCII	KBDCTY28	17
	Kazakh	KBDCTY78	17
	Kyrgyz (Cyrillic)	KBDCTY79	17
	Latin America	KBDCTY14	18
	Latvia	KBDCTY42	18
	Latvia (QWERTY)	KBDCTY43	18
	Lithuania	KBDCTY44	18
	Lithuania (IBM)	KBDCTY45	18
	Macedonia	KBDCTY34	18
	Malta	KBDCTY74	18
	Mongolian (Cyrillic)	KBDCTY86	18
	Norway	KBDCTY9	18
	Poland	KBDCTY20	18
	Polish (214)	KBDCTY57	18
	Polish (Programmers)	KBDCTY58	18
	Portugal	KBDCTY13	19
	Romania	KBDCTY25	19
	Russia	KBDCTY26	19
	Russian (MS)	KBDCTY67	19
	Russian (Typewriter)	KBDCTY68	19
	SCS	KBDCTY21	19
	Serbia (Cyrillic)	KBDCTY37	19
	Serbia (Latin)	KBDCTY36	19
	Slovakia	KBDCTY22	19
	Slovakia (QWERTY)	KBDCTY49	19
	Slovakia (QWERTZ)	KBDCTY48	19
	Slovenia	KBDCTY31	19
	Spain	KBDCTY10	20
	Spanish variation	KBDCTY51	20
	Sweden	KBDCTY23	20
	Switzerland (French)	KBDCTY29	20
	Switzerland (German)	KBDCTY6	20
	Tatar	KBDCTY85	20
	Turkey F	KBDCTY27	20
	Turkey Q	KBDCTY24	20
	Ukrainian	KBDCTY76	20
	United Kingdom	KBDCTY7	20

Selection	Setting * Indicates default	Serial Command # Indicates a numeric entry	Page
	United States (Dvorak right)	KBDCTY89	21
	United States (Dvorak left)	KBDCTY88	20
	United States (Dvorak)	KBDCTY87	20
	United States (International)	KBDCTY30	21
	Uzbek (Cyrillic)	KBDCTY77	21
Keyboard Conversion	*Keyboard Conversion Off	KBDCNV0	22
	Convert all Characters to Upper Case	KBDCNV1	22
	Convert all Characters to Lower Case	KBDCNV2	22
Keyboard Style	*Regular	KBDSTY0	21
	Caps Lock	KBDSTY1	21
	Shift Lock	KBDSTY2	21
	Automatic Caps Lock	KBDSTY6	21
	Autocaps via NumLock	KBDSTY7	22
	Emulate External Keyboard	KBDSTY5	22
Control Character Output	*Control Character Output Off	KBDNPE0	23
	Control Character Output On	KBDNPE1	23
Keyboard Modifiers	*Control + X Mode Off	KBDCAS0	23
	DOS Mode Control + X Mode On	KBDCAS1	24
	Windows Mode Control + X Mode On	KBDCAS2	23
	Windows Mode Prefix/Suffix Off	KBDCAS3	24
	*Turbo Mode Off	KBDTMD0	24
	Turbo Mode On	KBDTMD1	24
	*Numeric Keypad Off	KBDNPS0	24
	Numeric Keypad On	KBDNPS1	24
	*Auto Direct Connect Off	KBDADC0	24
	Auto Direct Connect On	KBDADC1	24
Baud Rate	300 BPS	232BAD0	25
	600 BPS	232BAD1	25
	1200 BPS	232BAD2	25
	2400 BPS	232BAD3	25
	4800 BPS	232BAD4	25
	9600 BPS	232BAD5	25
	19200 BPS	232BAD6	25
	38400 BPS	232BAD7	25
	57600 BPS	232BAD8	25
	*115200 BPS	232BAD9	26
Word Length: Data Bits, Stop Bits, and Parity	7 Data, 1 Stop, Parity Even	232WRD3	27

Selection	Setting * Indicates default	Serial Command # Indicates a numeric entry	Page
	7 Data, 1 Stop, Parity None	232WRD0	27
	7 Data, 1 Stop, Parity Odd	232WRD6	27
	7 Data, 2 Stop, Parity Even	232WRD4	27
	7 Data, 2 Stop, Parity None	232WRD1	27
	7 Data, 2 Stop, Parity Odd	232WRD7	27
	8 Data, 1 Stop, Parity Even	232WRD5	27
	*8 Data, 1 Stop, Parity None	232WRD2	27
	8 Data, 1 Stop, Parity Odd	232WRD8	27
	8 Data, 1 Stop, Parity Mark	232WRD14	28
RS232 Receiver Time-out	Range 0 - 300 seconds	232LPT###	28
RS232 Handshaking	*RTS/CTS Off	232CTS0	29
	Flow Control, No Timeout	232CTS1	28
	Two-Direction Flow Control	232CTS2	28
	Flow Control with Timeout	232CTS3	28
	RS232 Timeout	232DEL####	29
	*XON/XOFF Off	232XON0	29
	XON/XOFF On	232XON1	29
	*ACK/NAK Off	232ACK0	30
	ACK/NAK On	232ACK1	30
Scanner-Biopic Packet Mode	*Packet Mode Off	232PKT0	30
	Packet Mode On	232PKT2	30
Scanner-Biopic ACK/NAK Mode	*Biopic ACK/NAK Off	232NAK0	30
	Biopic ACK/NAK On	232NAK1	31
Scanner-Biopic ACK/NAK Timeout	ACK/NAK Timeout *5100	232DLK#####	31
Input/Output Selections			
Power Up Beeper	Power Up Beeper Off - Scanner	BEPPWRO	33
	*Power Up Beeper On - Scanner	BEPPWR1	33
Beep on BEL Character	Beep on BEL On	BELBEP1	33
	*Beep on BEL Off	BELBEP0	33
Trigger Click	On	BEPTRG1	34
	*Off	BEPTRG0	34
Beeper - Good Read	Off	BEPBEP0	34
	*On	BEPBEP1	34

Selection	Setting * Indicates default	Serial Command # Indicates a numeric entry	Page
Beeper Volume - Good Read	Off	BEPLVLO	34
	Low	BEPLVL1	34
	Medium	BEPLVL2	34
	*High	BEPLVL3	34
Beeper Pitch - Good Read (Frequency)	Low (1600) (min 400Hz)	BEPFQ11600	35
	*Medium (2700)	BEPFQ12700	35
	High (4200) (max 9000Hz)	BEPFQ14200	35
Beeper Pitch - Error (Frequency)	*Razz (250) (min 200Hz)	BEPFQ2250	35
	Medium (3250)	BEPFQ23250	35
	High (4200) (max 9000Hz)	BEPFQ24200	35
Beeper Duration - Good Read	*Normal Beep	BEPBIPO	36
	Short Beep	BEPBIP1	36
LED - Good Read	Off	BEPLED0	36
	*On	BEPLED1	36
Number of Beeps - Error	*1	BEPERR1	37
	Range 1 - 9	BEPERR#	37
Number of Beeps - Good Read	*1	BEPRPT1	36
	Range 1 - 9	BEPRPT#	36
Good Read Delay	*No Delay	DLYGRD0	37
	Short Delay (500 ms)	DLYGRD500	37
	Medium Delay (1000 ms)	DLYGRD1000	37
	Long Delay (1500 ms)	DLYGRD1500	37
User-Specified Good Read Delay	Range 0 - 30,000 ms	DLYGRD#####	37
Manual Trigger Modes	*Manual Trigger - Normal	PAPHHF	38
	Manual Trigger - Enhanced	PAPHHS	38
LED Illumination - Manual Trigger	Off	PWRNOLO	38
	Low	PWRNOL100	38
	*High	PWRNOL150	38
Serial Trigger Mode	Read Time-Out (0 - 300,000 ms) *30,000	TRGSTO####	40
Presentation	Presentation Mode	PAPTPR	40
LED Illumination - Presentation Mode (Not supported with the Gen 7 software revision)	Off	PWRLDC0	41
	Low	PWRLDC100	41
	*High	PWRLDC150	41
Presentation LED Behavior After Decode	*LEDs On	TRGPCK1	41
	LEDs Off	TRGPCK0	41

Selection	Setting * Indicates default	Serial Command # Indicates a numeric entry	Page
Presentation Sensitivity (Not supported with the Gen 7 software revision)	Range 0-20 (*1)	TRGPMS##	42
Presentation Centering Window	Presentation Centering On	PDCWIN1	43
	*Presentation Centering Off	PDCWIN0	43
	Left of Presentation Centering Window (*40%)	PDCLFT###	44
	Right of Presentation Centering Window (*60%)	PDCRGT###	44
	Top of Presentation Centering Window (*40%)	PDCTOP###	43
	Bottom of Presentation Centering Window (*60%)	PDCBOT###	44
CodeGate	*CodeGate Off Out-of-Stand	AOSCGD0.	44
	CodeGate On Out-of-Stand	AOSCGD1.	44
Streaming Presentation	Streaming Presentation Mode - Normal	PAPSPN	44
	Streaming Presentation Mode - Enhanced	PAPSPE	45
Mobile Phone Read Mode	Hand Held Scanning - Mobile Phone	PAPHHC	45
	Streaming Presentation - Mobile Phone	PAPSPC	45
Hands Free Time-Out	Range 0 - 300,000 ms	TRGPTO#####	45
Character Activation Mode	*Off	HSTCEN0	46
	On	HSTCEN1	46
	Activation Character	HSTACH##	46
	Do Not End Character Activation After Good Read	HSTCGD0	47
	*End Character Activation After Good Read	HSTCGD1	47
	Character Activation Laser Timeout (Range 1 - 65525) *5000 ms	HSTCDT#####	46
Character Deactivation Mode	*Off	HSTDEN0	47
	On	HSTDEN1	47
	Deactivation Character	HSTDCH##	48
Reread Delay	Short (500 ms)	DLYRRD500	48
	*Medium (750 ms)	DLYRRD750	48
	Long (1000 ms)	DLYRRD1000	48
	Extra Long (2000 ms)	DLYRRD2000	48
User-Specified Reread Delay	Range 0 - 65,535 ms	DLYRRD#####	48
Illumination Lights	*Lights On	SCNLED1	49
	Lights Off	SCNLED0	49
Aimer Delay	200 milliseconds	SCNDLY200	50
	400 milliseconds	SCNDLY400	50
	*Off (no delay)	SCNDLY0	50
User-Specified Aimer Delay	Range 0 - 4,000 ms	SCNDLY#####	50

Selection	Setting * Indicates default	Serial Command # Indicates a numeric entry	Page
2D Reread Delay	*2D Reread Delay Off	DLY2RR0	49
	Short (1000ms)	DLY2RR1000	49
	Medium (2000ms)	DLY2RR2000	49
	Long (3000ms)	DLY2RR3000	49
	Extra Long (4000ms)	DLY2RR4000	49
Aimer Mode	Off	SCNAIM0	50
	*Interlaced	SCNAIM2	50
Centering Window	Centering On	DECWIN1	52
	*Centering Off	DECWIN0	52
	Left of Centering Window (*40%)	DECLFT###	52
	Right of Centering Window (*60%)	DECRGT###	52
	Top of Centering Window (*40%)	DECTOP###	52
	Bottom of Centering Window (*60%)	DECBOT###	52
Preferred Symbology	On	PRFENA1	53
	*Off	PRFENA0	53
	High Priority Symbology	PRFCOD##	53
	Low Priority Symbology	PRFBLK##	53
	Preferred Symbology Timeout (*500) Range 1-3000	PRFPTO####	54
	Preferred Symbology Default	PRFDFT	54
Output Sequence Editor	Enter Sequence	SEQBLK	57
	Default Sequence	SEQDFT	57
Partial Sequence	Transmit Partial Sequence	SEQTTS1	57
	*Discard Partial Sequence	SEQTTS0	57
Require Output Sequence	Required	SEQ_EN2	57
	On/Not Required	SEQ_EN1	58
	*Off	SEQ_EN0	58
Multiple Symbols	On	SHOTGN1	58
	*Off	SHOTGN0	58
No Read	On	SHWNRD1	58
	*Off	SHWNRD0	58
Video Reverse	Video Reverse Only	VIDREV1	59
	Video Reverse and Standard Barcodes	VIDREV2	59
	*Video Reverse Off	VIDREVO	59
Working Orientation	*Upright	ROTATN0	60
	Vertical, Bottom to Top (Rotate CCW 90°)	ROTATN1	60
	Upside Down	ROTATN2	60
	Vertical, Top to Bottom (Rotate CW 90°)	ROTATN3	60

Selection	Setting * Indicates default	Serial Command # Indicates a numeric entry	Page
Prefix/Suffix Selections			
Add CR Suffix to All Symbologies		VSUFCR	63
Prefix	Add Prefix	PREBK2##	64
	Clear One Prefix	PRECL2	64
	Clear All Prefixes	PRECA2	64
Suffix	Add Suffix	SUFBK2##	64
	Clear One Suffix	SUFCL2	64
	Clear All Suffixes	SUFCA2	64
Function Code Transmit	*Enable	RMVFNC0	64
	Disable	RMVFNC1	64
Intercharacter Delay	Range 0 - 1000 (5ms increments)	DLYCHR##	65
User Specified Intercharacter Delay	Delay Length 0 - 1000 (5ms increments)	DLYCRX##	65
	Character to Trigger Delay	DLY_XX##	65
Interfunction Delay	Range 0 - 1000 (5ms increments)	DLYFNC##	66
Intermessage Delay	Range 0 - 1000 (5ms increments)	DLYMSG##	66
Data Formatter Selections			
Data Format Editor	*Default Data Format (None)	DFMDF3	68
	Enter Data Format	DFMBK3##	69
	Clear One Data Format	DFMCL3	69
	Clear All Data Formats	DFMCA3	69
Data Formatter	Data Formatter Off	DFM_EN0	83
	*Data Formatter On, Not Required, Keep Prefix/Suffix	DFM_EN1	84
	Data Format Required, Keep Prefix/Suffix	DFM_EN2	84
	Data Formatter On, Not Required, Drop Prefix/Suffix	DFM_EN3	84
	Data Format Required, Drop Prefix/Suffix	DFM_EN4	84
Data Format Non-Match Error Tone	*Data Format Non-Match Error Tone On	DFMDECO	84
	Data Format Non-Match Error Tone Off	DFMDEC1	84
Primary/Alternate Data Formats	Primary Data Format	ALTFNM0	85
	Data Format 1	ALTFNM1	85
	Data Format 2	ALTFNM2	85
	Data Format 3	ALTFNM3	85

Selection	Setting * Indicates default	Serial Command # Indicates a numeric entry	Page
Single Scan Data Format Change	Single Scan-Primary Data Format	VSAF_0	85
	Single Scan-Data Format 1	VSAF_1	85
	Single Scan-Data Format 2	VSAF_2	85
	Single Scan-Data Format 3	VSAF_3	86
External Input/Output			
External Input	*External Trigger Control Off	EXTTRGO	87
	External Trigger Control On	EXTTRG1	87
	*External Trigger Polarity High	EXTTPO1	88
	External Trigger Polarity Low	EXTTPO0	88
External Output	*External Illumination Control Off	EXTILLO	89
	External Illumination Control On	EXTILL1	90
Symbologies			
All Symbologies	All Symbologies Off	ALLENA0	94
	All Symbologies On	ALLENA1	94
Codabar	Default All Codabar Settings	CBRDFT	95
	Off	CBRENA0	95
	*On	CBRENA1	95
Codabar Start/Stop Char.	*Don't Transmit	CBRSSX0	95
	Transmit	CBRSSX1	95
Codabar Check Char.	*No Check Char.	CBRCK20	96
	Validate, But Don't Transmit	CBRCK21	96
	Validate, and Transmit	CBRCK22	96
Codabar Concatenation	*Off	CBRCCT0	96
	On	CBRCCT1	96
	Require	CBRCCT2	96
Codabar Message Length	Minimum (2 - 60) *4	CBRMIN##	97
	Maximum (2 - 60) *60	CBRMAX##	97
Code 39	Default All Code 39 Settings	C39DFT	97
	Off	C39ENA0	97
	*On	C39ENA1	97
Code 39 Start/Stop Char.	*Don't Transmit	C39SSX0	97
	Transmit	C39SSX1	97
Code 39 Check Char.	*No Check Char.	C39CK20	98
	Validate, But Don't Transmit	C39CK21	98
	Validate, and Transmit	C39CK22	98

Selection	Setting * Indicates default	Serial Command # Indicates a numeric entry	Page
Code 39 Message Length	Minimum (0 - 48) *0	C39MIN##	98
	Maximum (0 - 48) *48	C39MAX##	98
Code 39 Append	*Off	C39APP0	99
	On	C39APP1	99
Code 32 Pharmaceutical (PARAF)	*Off	C39B320	99
	On	C39B321	99
Code 39 Full ASCII	*Off	C39ASC0	100
	On	C39ASC1	100
	Code 39 Code Page	C39DCP	101
Interleaved 2 of 5	Default All Interleaved 2 of 5 Settings	I25DFT	101
	Off	I25ENAO	101
	*On	I25ENA1	101
Interleaved 2 of 5 Check Digit	*No Check Char.	I25CK20	102
	Validate, But Don't Transmit	I25CK21	102
	Validate, and Transmit	I25CK22	102
Interleaved 2 of 5 Message Length	Minimum (2 - 80) *4	I25MIN##	102
	Maximum (2 - 80) *80	I25MAX##	102
NEC 2 of 5	Default All NEC 2 of 5 Settings	N25DFT	103
	Off	N25ENAO	103
	*On	N25ENA1	103
NEC 2 of 5 Check Digit	*No Check Char.	N25CK20	103
	Validate, But Don't Transmit	N25CK21	103
	Validate, and Transmit	N25CK22	103
NEC 2 of 5 Message Length	Minimum (2 - 80) *4	N25MIN##	104
	Maximum (2 - 80) *80	N25MAX##	104
Code 93	Default All Code 93 Settings	C93DFT	104
	Off	C93ENAO	104
	*On	C93ENA1	106
Code 93 Message Length	Minimum (0 - 80) *0	C93MIN##	104
	Maximum (0 - 80) *80	C93MAX##	104
Code 93 Append	On	C93APP1	105
	*Off	C93APP0	105
Code 93 Code Page	Code 93 Code Page	C93DCP	105
Straight 2 of 5 Industrial	Default All Straight 2 of 5 Industrial Settings	R25DFT	106
	*Off	R25ENAO	106
	On	R25ENA1	106

Selection	Setting * Indicates default	Serial Command # Indicates a numeric entry	Page
Straight 2 of 5 Industrial Message Length	Minimum (1 - 48) *4	R25MIN##	106
	Maximum (1 - 48) *48	R25MAX##	106
Straight 2 of 5 IATA	Default All Straight 2 of 5 IATA Settings	A25DFT	107
Straight 2 of 5 IATA	*Off	A25ENA0	107
	On	A25ENA1	107
Straight 2 of 5 IATA Message Length	Minimum (1 - 48) *4	A25MIN##	107
	Maximum (1 - 48) *48	A25MAX##	107
Matrix 2 of 5	Default All Matrix 2 of 5 Settings	X25DFT	108
	*Off	X25ENA0	108
	On	X25ENA1	108
Matrix 2 of 5 Message Length	Minimum (1 - 80) *4	X25MIN##	108
	Maximum (1 - 80) *80	X25MAX##	108
Code 11	Default All Code 11 Settings	C11DFT	109
	*Off	C11ENA0	109
	On	C11ENA1	109
Code 11 Check Digits Required	1 Check Digit	C11CK20	109
	*2 Check Digits	C11CK21	109
Code 11 Message Length	Minimum (1 - 80) *4	C11MIN##	109
	Maximum (1 - 80) *80	C11MAX##	109
Code 128	Default All Code 128 Settings	128DFT	110
	Off	128ENA0	110
	*On	128ENA1	110
ISBT Concatenation	*Off	ISBENA0	110
	On	ISBENA1	110
Code 128 Message Length	Minimum (0 - 80) *0	128MIN##	110
	Maximum (0 - 80) *80	128MAX##	111
Code 128 Append	On	128APP1	110
	*Off	128APPO	111
Code 128 Code Page	Code 128 Code Page (*2)	128DCP##	111
GS1-128	Default All GS1-128 Settings	GS1DFT	112
	*On	GS1ENA1	112
	Off	GS1ENA0	112
GS1-128 Message Length	Minimum (1 - 80) *1	GS1MIN##	112
	Maximum (0 - 80) *80	GS1MAX##	112
Telepen	Default All Telepen Settings	TELDFT	113
	*Off	TELENA0	113
	On	TELENA1	113

Selection	Setting * Indicates default	Serial Command # Indicates a numeric entry	Page
Telepen Output	*AIM Telepen Output	TELOLD0	113
	Original Telepen Output	TELOLD1	113
Telepen Message Length	Minimum (1 - 60) *1	TELMIN##	113
	Maximum (1 - 60) *60	TELMAX##	114
UPC-A	Default All UPC-A Settings	UPADFT	114
	Off	UPAENA0	114
	*On	UPAENA1	114
UPC-A Check Digit	Off	UPACKX0	114
	*On	UPACKX1	114
UPC-A Number System	Off	UPANSX0	115
	*On	UPANSX1	115
UPC-A 2 Digit Addenda	*Off	UPAAD20	115
	On	UPAAD21	115
UPC-A 5 Digit Addenda	*Off	UPAAD50	115
	On	UPAAD51	115
UPC-A Addenda Required	*Not Required	UPAARQ0	116
	Required	UPAARQ1	115
UPC-A Addenda Separator	Off	UPAADS0	116
	*On	UPAADS1	116
UPC-A/EAN-13 with Extended Coupon Code	*Off	CPNENA0	116
	Allow Concatenation	CPNENA1	116
	Require Concatenation	CPNENA2	116
Coupon GS1 DataBar Output	GS1 Output Off	CPNGS10	117
	GS1 Output On	CPNGS11	117
UPC-E0	Default All UPC-E Settings	UPEDFT	117
	Off	UPEEN00	117
	*On	UPEEN01	117
UPC-E0 Expand	*Off	UPEEXP0	118
	On	UPEEXP1	117
UPC-E0 Addenda Required	Required	UPEARQ1	118
	*Not Required	UPEARQ0	118
UPC-E0 Addenda Separator	*On	UPEADS1	118
	Off	UPEADS0	118
UPC-E0 Check Digit	Off	UPECKX0	118
	*On	UPECKX1	118
UPC-E0 Number System	Off	UPENSX0	119
	*On	UPENSX1	119

Selection	Setting * Indicates default	Serial Command # Indicates a numeric entry	Page
UPC-E0 Addenda	2 Digit Addenda On	UPEAD21	119
	*2 Digit Addenda Off	UPEAD20	119
	5 Digit Addenda On	UPEAD51	119
	*5 Digit Addenda Off	UPEAD50	119
UPC-E1	*Off	UPEEN10	120
	On	UPEEN11	119
EAN/JAN-13	Default All EAN/JAN Settings	E13DFT	120
	Off	E13ENAO	120
	*On	E13ENA1	120
Convert UPC-A to EAN-13	UPC-A Converted to EAN-13	UPAENA0	120
	*Do not Convert UPC-A	UPAENA1	120
EAN/JAN-13 Check Digit	Off	E13CKX0	121
	*On	E13CKX1	120
EAN/JAN-13 2 Digit Addenda	2 Digit Addenda On	E13AD21	121
	*2 Digit Addenda Off	E13AD20	121
	5 Digit Addenda On	E13AD51	121
	*5 Digit Addenda Off	E13AD50	121
EAN/JAN-13 Addenda Required	*Not Required	E13ARQ0	121
	Required	E13ARQ1	121
EAN/JAN-13 Addenda Separator	Off	E13ADS0	122
	*On	E13ADS1	121
ISBN Translate	*Off	E13ISB0	122
	On	E13ISB1	122
EAN/JAN-8	Default All EAN/JAN 8 Settings	EA8DFT	122
	Off	EA8ENAO	122
	*On	EA8ENA1	122
EAN/JAN-8 Check Digit	Off	EA8CKX0	123
	*On	EA8CKX1	122
EAN/JAN-8 Addenda	*2 Digit Addenda Off	EA8AD20	123
	2 Digit Addenda On	EA8AD21	123
	*5 Digit Addenda Off	EA8AD50	123
	5 Digit Addenda On	EA8AD51	123
EAN/JAN-8 Addenda Required	*Not Required	EA8ARQ0	123
	Required	EA8ARQ1	123
EAN/JAN-8 Addenda Separator	Off	EA8ADS0	124
	*On	EA8ADS1	124

Selection	Setting * Indicates default	Serial Command # Indicates a numeric entry	Page
MSI	Default All MSI Settings	MSIDFT	124
	*Off	MSIENAO	124
	On	MSIENA1	124
MSI Check Character	*Validate Type 10, but Don't Transmit	MSICHK0	125
	Validate Type 10 and Transmit	MSICHK1	125
	Validate 2 Type 10 Chars, but Don't Transmit	MSICHK2	125
	Validate 2 Type 10 Chars and Transmit	MSICHK3	125
	Validate Type 11 then Type 10 Char, but Don't Transmit	MSICHK4	125
	Validate Type 11 then Type 10 Char and Transmit	MSICHK5	125
	Disable MSI Check Characters	MSICHK6	125
MSI Message Length	Minimum (4 - 48) *4	MSIMIN##	125
	Maximum (4 - 48) *48	MSIMAX##	125
GS1 DataBar Omnidirectional	Default All GS1 DataBar Omnidirectional Settings	RSSDFT	126
	Off	RSENAO	126
	*On	RSEENA1	126
GS1 DataBar Limited	Default All GS1 DataBar Limited Settings	RSLDFT	126
	Off	RSLENAO	126
	*On	RSLENA1	126
GS1 DataBar Expanded	Default All GS1 DataBar Expanded Settings	RSEDFT	126
	Off	RSEENAO	127
	*On	RSEENA1	127
GS1 DataBar Expanded Msg. Length	Minimum (4 - 74) *4	RSEMIN###	127
	Maximum (4 - 74) *74	RSEMAX###	127
Trioptic Code	*Off	TRIENAO	127
	On	TRIENA1	127
Codablock A	Default All Codablock A Settings	CBADFT	128
	*Off	CBAENAO	128
	On	CBAENA1	128
Codablock A Msg. Length	Minimum (1 - 600) *1	CBAMIN####	128
	Maximum (1 - 600) *600	CBAMAX####	128
Codablock F	Default All Codablock F Settings	CBFDFT	129
	*Off	CBFENAO	129
	On	CBFENA1	129
Codablock F Msg. Length	Minimum (1 - 2048) *1	CBFMIN####	129
	Maximum (1 - 2048) *2048	CBFMAX####	129

Selection	Setting * Indicates default	Serial Command # Indicates a numeric entry	Page
PDF417	Default All PDF417 Settings	PDFDFT	130
	*On	PDFENA1	130
	Off	PDFENA0	130
PDF417 Msg. Length	Minimum (1-2750) *1	PDFMIN####	130
	Maximum (1-2750) *2750	PDFMAX####	130
MacroPDF417	*On	PDFMAC1	130
	Off	PDFMAC0	130
MicroPDF417	Default All Micro PDF417 Settings	MPDDFT	131
	On	MPDENA1	131
	*Off	MPDENA0	131
MicroPDF417 Msg. Length	Minimum (1-366) *1	MPDMIN####	131
	Maximum (1-366) *366	MPDMAX####	131
GS1 Composite Codes	On	COMENA1	131
	*Off	COMENA0	131
UPC/EAN Version	On	COMUPC1	132
	*Off	COMUPC0	132
GS1 Composite Codes Msg. Length	Minimum (1-2435) *1	COMMINS####	132
	Maximum (1-2435) *2435	COMMAX####	132
GS1 Emulation	GS1-128 Emulation	EANEMU1	133
	GS1 DataBar Emulation	EANEMU2	133
	GS1 Code Expansion Off	EANEMU3	133
	EAN8 to EAN13 Conversion	EANEMU4	133
	*GS1 Emulation Off	EANEMU0	133
TCIF Linked Code 39	On	T39ENA1	133
	*Off	T39ENA0	133
QR Code	Default All QR Code Settings	QRCDFT	134
	*On	QRCENA1	134
	Off	QRCENA0	134
QR Code Msg. Length	Minimum (1-7089) *1	QRCMIN####	134
	Maximum (1-7089) *7089	QRCMAX####	134
QR Code Append	*On	QRCAPP1	134
	Off	QRCAPP0	135
QR Code Page	QR Code Page (*3)	QRCDCP##	135
Data Matrix	Default All Data Matrix Settings	IDMDFT	135
	*On	IDMENA1	135
	Off	IDMENA0	135

Selection	Setting * Indicates default	Serial Command # Indicates a numeric entry	Page
Data Matrix Msg. Length	Minimum (1-3116) *1	IDMMIN####	136
	Maximum (1-3116) *3116	IDMMAX####	136
Data Matrix Code Page	Data Matrix Code Page (*51)	IDMDCP##	136
MaxiCode	Default All MaxiCode Settings	MAXDFT	137
	On	MAXENA1	137
	*Off	MAXENAO	137
MaxiCode Msg. Length	Minimum (1-150) *1	MAXMIN###	137
	Maximum (1-150) *150	MAXMAX###	137
Aztec Code	Default All Aztec Code Settings	AZTDFT	138
	*On	AZTENA1	138
	Off	AZTENAO	138
Aztec Code Msg. Length	Minimum (1-3832) *1	AZTMIN####	138
	Maximum (1-3832) *3832	AZTMAX####	138
Aztec Append	On	AZTAPP1	138
	*Off	AZTAPP0	139
Aztec Code Page	Aztec Code Page (*51)	AZTDCP##	139
Chinese Sensible (Han Xin) Code	Default All Han Xin Code Settings	HX_DFT	139
	On	HX_ENA1	139
	*Off	HX_ENAO	139
Chinese Sensible (Han Xin) Code Msg. Length	Minimum (1-7833) *1	HX_MIN####	139
	Maximum (1-7833) *7833	HX_MAX####	140
Postal Codes - 2D			
2D Postal Codes	*Off	POSTAL0	140
Single 2D Postal Codes	Australian Post On	POSTAL1	141
	British Post On	POSTAL7	141
	Canadian Post On	POSTAL30	141
	Intelligent Mail Barcode On	POSTAL10	141
	Japanese Post On	POSTAL3	141
	KIX Post On	POSTAL4	141
	Planet Code On	POSTAL5	141
	Postal-4i On	POSTAL9	141
	Postnet On	POSTAL6	141
	Postnet with B and B' Fields On	POSTAL11	141
Combination 2D Postal Codes	InfoMail On	POSTAL2	142
	InfoMail and British Post On	POSTAL8	143
	Intelligent Mail Barcode and Postnet with B and B' Fields On	POSTAL20	143

Selection	Setting * Indicates default	Serial Command # Indicates a numeric entry	Page
	Postnet and Postal-4i On	POSTAL14	143
	Postnet and Intelligent Mail Barcode On	POSTAL16	143
	Postal-4i and Intelligent Mail Barcode On	POSTAL17	143
	Postal-4i and Postnet with B and B' Fields On	POSTAL19	143
	Planet and Postnet On	POSTAL12	143
	Planet and Postnet with B and B' Fields On	POSTAL18	143
	Planet and Postal-4i On	POSTAL13	143
	Planet and Intelligent Mail Barcode On	POSTAL15	143
	Planet, Postnet, and Postal-4i On	POSTAL21	144
	Planet, Postnet, and Intelligent Mail Barcode On	POSTAL22	144
	Planet, Postal-4i, and Intelligent Mail Barcode On	POSTAL23	144
	Postnet, Postal-4i, and Intelligent Mail Barcode On	POSTAL24	144
	Planet, Postal-4i, and Postnet with B and B' Fields On	POSTAL25	144
	Planet, Intelligent Mail Barcode, and Postnet with B and B' Fields On	POSTAL26	144
	Postal-4i, Intelligent Mail Barcode, and Postnet with B and B' Fields On	POSTAL27	144
	Planet, Postal-4i, Intelligent Mail Barcode, and Postnet On	POSTAL28	144
	Planet, Postal-4i, Intelligent Mail Barcode, and Postnet with B and B' Fields On	POSTAL29	144
Planet Code Check Digit	Transmit	PLNCKX1	145
	*Don't Transmit	PLNCKX0	145
Postnet Check Digit	Transmit	NETCKX1	145
	*Don't Transmit	NETCKX0	145
Australian Post Interpretation	Bar Output	AUSINT0	145
	Numeric N Table	AUSINT1	146
	Alphanumeric C Table	AUSINT2	146
	Combination N and C Tables	AUSINT3	146
Postal Codes - Linear			
China Post (Hong Kong 2 of 5)	Default All China Post (Hong Kong 2 of 5) Settings	CPCDFT	146
	*Off	CPCENA0	146
	On	CPCENA1	146
China Post (Hong Kong 2 of 5) Msg. Length	Minimum (2 - 80) *4	CPCMIN##	147
	Maximum (2 - 80) *80	CPCMAX##	147

Selection	Setting * Indicates default	Serial Command # Indicates a numeric entry	Page
Korea Post	Default All Korea Post Settings	KPCDFT	147
	*Off	KPCENA0	147
	On	KPCENA1	147
Korea Post Msg. Length	Minimum (2 - 80) *4	KPCMIN##	147
	Maximum (2 - 80) *48	KPCMAX##	147
Korea Post Check Digit	Transmit Check Digit	KPCCHK1	148
	*Don't Transmit Check Digit	KPCCHK0	148
Imaging Default Commands			
Image Snap	Default all Imaging Commands	IMGDFT	149
	Imaging Style - Decoding	SNPSTY0	150
	*Imaging Style - Photo	SNPSTY1	150
	Imaging Style - Manual	SNPSTY2	150
	Beeper On	SNPBEP1	150
	*Beeper Off	SNPBEP0	150
	*Wait for Trigger Off	SNPTRG0	151
	Wait for Trigger On	SNPTRG1	151
	*LED State - Off	SNPLED0	151
	LED State - On	SNPLED1	151
	Exposure (Gen 6: 1-7874 microseconds, *7874) (Gen 7: 1-10000000 microseconds, *10000000)	SNPEXP	151
	*Gain - None	SNPGAN1	152
	Gain - Medium	SNPGAN2	152
	Gain - Heavy	SNPGAN4	152
	Gain - Maximum	SNPGAN8	152
	Target White Value (0-255) *125	SNPWHT###	152
	Delta for Acceptance (0-255) *25 (Gen 6), *30 (Gen 7)	SNPDEL###	152
	Update Tries (0-10) *6	SNPTRY##	153
	Target Set Point Percentage (1-99) *50	SNPPCT##	153
	Image Ship	*Infinity Filter - Off	IMGINFO
Infinity Filter - On		IMGINF1	154
*Compensation Off		IMGCOR0	154
Compensation On		IMGCOR1	154
*Pixel Depth - 8 bits/pixel (grayscale)		IMGBPP8	154
Pixel Depth - 1 bit/pixel (B&W)		IMGBPP1	154
*Don't Sharpen Edges		IMGEDG0	155

Selection	Setting * Indicates default	Serial Command # Indicates a numeric entry	Page
	Sharpen Edges (0-23)	IMGEDG###	155
	*File Format - JPEG	IMGFMT6	155
	File Format - KIM	IMGFMT0	155
	File Format - TIFF binary	IMGFMT1	155
	File Format - TIFF binary group 4, compressed	IMGFMT2	155
	File Format - TIFF grayscale	IMGFMT3	155
	File Format - Uncompressed binary	IMGFMT4	155
	File Format - Uncompressed grayscale	IMGFMT5	155
	File Format - BMP	IMGFMT8	155
	*Histogram Stretch Off	IMGHIS0	156
	Histogram Stretch On	IMGHIS1	156
	*Noise Reduction Off	IMGFSP0	157
	Noise Reduction On	IMGFSP1	157
	Invert Image around X axis	IMGNVX1	156
	Invert Image around Y axis	IMGNVY1	156
	Rotate Image none	IMGROTO	157
	Rotate Image 90° right	IMGROT1	157
	Rotate Image 180° right	IMGROT2	157
	Rotate Image 90° left	IMGROT3	157
	JPEG Image Quality (0-100) *50	IMGJQF###	158
	*Gamma Correction Off	IMGGAM0	158
	Gamma Correction On (0-1000)	IMGGAM###	158
	Image Crop - Left (0-640) *0	IMGWNL###	159
	Image Crop - Right (0-640) *639	IMGWNR###	159
	Image Crop - Top (0-480) *0	IMGWNT###	159
	Image Crop - Bottom (0-480) *479	IMGWNB###	159
	Image Crop - Margin (1-238) *0	IMGMAR###	159
	Protocol - None (raw)	IMGXFR0	160
	Protocol - None (default USB)	IMGXFR2	160
	Protocol - Hmodem Compressed	IMGXFR3	160
	Protocol - Hmodem	IMGXFR4	160
	Ship Every Pixel	IMGSUB1	160
	Ship Every 2nd Pixel	IMGSUB2	160
	Ship Every 3rd Pixel	IMGSUB3	160
	*Document Image Filter Off	IMGUSH0	161
	Document Image Filter On (0-255)	IMGUSH###	161
	*Don't Ship Histogram	IMGHST0	162

Selection	Setting * Indicates default	Serial Command # Indicates a numeric entry	Page
	Ship Histogram	IMGHST1	162
Image Size Compatibility	Force VGA Resolution	IMGVGA1	162
	*Native Resolution	IMGVGA0	162
Intelligent Signature Capture	Optimize On	DECBND1	163
	*Optimize Off	DECBND0	163
Utilities			
Add Code I.D. Prefix to All Symbologies (Temporary)		PRECA2,BK2995C8 O!	169
Show Decoder Revision		REV_DR	169
Show Scan Driver Revision		REV_SD	170
Show Software Revision		REVINP	170
Show Data Format		DFMBK3?	170
Test Menu	On	TSTMNU1	170
	*Off	TSTMNU0	170
Application Plug-Ins (Apps)	*Decoding Apps On	PLGDCE1	171
	Decoding Apps Off	PLGDCE0	171
	*Formatting Apps On	PLGFOE1	171
	Formatting Apps Off	PLGFOE0	171
	List Apps	PLGINP	171
Resetting the Factory Defaults	Remove Custom Defaults	DEFOVR	173
	Activate Defaults	DEFALT	173

3320 Scanner Product Specifications

Parameter	Specification
Dimensions (Typical):	
Height	1.0 inches (26mm)
Length	2.9 inches (73mm)
Width	2.0 inches (51mm)
Weight	2.7 ounces (77g)
Wavelength:	
Illumination LED	633nm
Aimer LED	528nm
Image Size	844 x 640 pixels
Skew Angle	±65°
Pitch Angle	±45°
Motion Tolerance: Enhanced Streaming Presentation Trigger	SR, HD version: up to 200 inches per second for 13 mil UPC ER version: up to 106 inches per second for 13 mil UPC
Symbol Contrast	Grade 1.0 (20% or greater)
Voltage Requirements	4 - 5.5 VDC at input connector
Current Draw @5VDC	Scanning Standby 450mA, 2.3W90mA, 0.45W
Power Supply Noise Rejection	Maximum 100mV peak to peak, 10 to 100 kHz
Temperature Ranges:	
Operating	-4°F to +122°F (-20°C to 50°C)
Storage	-4°F to +158°F (-20°C to 70°C)
Humidity	5 to 95% non-condensing

Mechanical Drop	Operational after 30 drops from 4.9 feet (1.5m) to concrete at 23°C
Vibration	Withstands 5G peak from 22 to 300 Hz
ESD Tolerance	Up to 15kV direct air Up to 8 kV indirect coupling plane
Solids and Water Protection	IP53

Depth of Field

Typical Performance

Focus		Standard Range (SR)		High Density (HD)		Extended Range (ER)	
		Near Distance	Far Distance	Near Distance	Far Distance	Near Distance	Far Distance
5 mil Code 39	in.	2.16	6.26	.87	4.92	5.35	8.66
	mm	55	159	22	125	136	220
13 mil UPC	in.	1.53	17.13	1.18	7.48	2.32	20.31
	mm	39	435	30	190	59	516
10 mil Data Matrix	in.	1.85	8.50	.63	5.59	4.76	10.79
	mm	47	216	16	142	121	274
20 mil Data Matrix	in.	1.30	16.30	.75	8.23	2.05	19.13
	mm	33	414	19	209	52	486

Guaranteed Performance

Focus		Standard Range (SR)		High Density (HD)		Extended Range (ER)	
		Near Distance	Far Distance	Near Distance	Far Distance	Near Distance	Far Distance
5 mil Code 39	in.	2.52	5.71	1.18	4.68	5.79	8.82
	mm	64	145	30	119	147	224
13 mil UPC	in.	2.16	16.14	1.26	6.97	2.79	19.02
	mm	55	410	32	177	71	483
10 mil Data Matrix	in.	2.44	7.68	.71	5.32	5.32	9.10
	mm	62	195	18	135	135	254
20 mil Data Matrix	in.	1.85	14.84	.91	7.91	4.02	15.98
	mm	47	377	23	201	102	406

Note: Performance may be impacted by barcode quality and environmental conditions.

Mounting Specifications

The 3320 has three M3 x 0.5mm threaded inserts (5.0mm maximum depth) on the bottom of the scanner for mounting with screws. Do not exceed 3cm-kg torque.

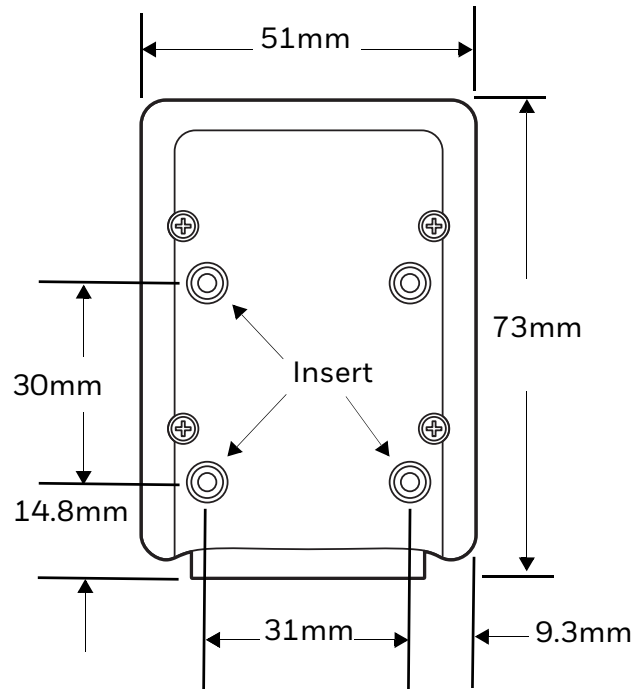

Mounting General Guidelines

- Avoid specular reflections, caused by ambient and internal light sources.
- The barcode should be slightly off perpendicular to the axis of the scanner.
- To reduce specular reflections, the skew angle can vary significantly depending on the application such as: ambient illumination sources, code size, and code type.
- Excessive angles should be avoided.
- Other factors, such as surface qualities, mounting distances, secondary windows, and external illumination can easily impact these recommendations.
- If a secondary window is used, the window should be mounted as close to the front of scanner as possible at a 90° angle to the optical axis to avoid specular reflections.
- For secondary windows, Honeywell recommends the following:
 - Optical quality glass
 - >95% transmission in the nominal 650nm wavelength
 - Anti-reflective coating on both sides

- Avoid window thickness above 2mm
- A skew angle of 15° to 20° between the normal of the barcode's surface and the optical axis of the imager is sufficient to avoid specular reflections.
- Avoid pitch angles above 20° to prevent code compression.

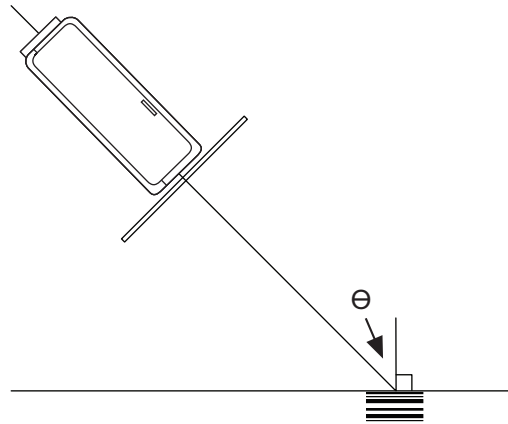

Standard Cable Pinouts

Keyboard Wedge

15 Pin D-type

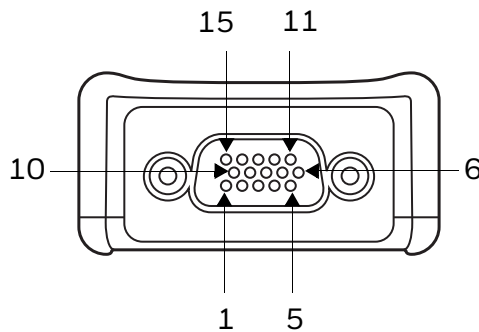

- | | |
|----|------------------|
| 1 | PC Data |
| 2 | KB Clock |
| 3 | KB Data |
| 4 | Reserved |
| 5 | Reserved |
| 6 | Ground |
| 7 | Reserved |
| 8 | Jump to Pin 11 |
| 9 | PC Clock |
| 10 | Host Power (+5V) |
| 11 | Adapter Power |
| 12 | Jump to Pin 10 |
| 13 | Reserved |
| 14 | Reserved |
| 15 | Reserved |

Note: Use of a cable with improper pin assignments may lead to damage to the unit. Use of any cables not provided by the manufacturer may result in damage not covered by your warranty.

Serial Output

15 Pin D-type

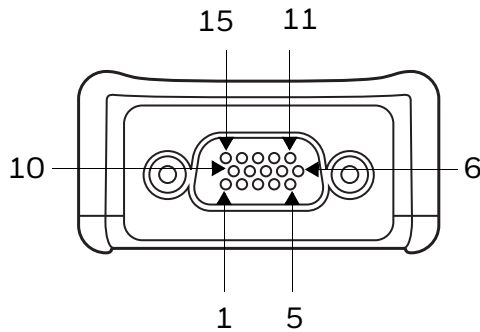

- 1 Reserved
- 2 Reserved
- 3 Reserved
- 4 Reserved
- 5 Reserved
- 6 Ground
- 7 TXD
- 8 RXD
- 9 Reserved
- 10 Reserved
- 11 Adapter Power
- 12 CTS
- 13 RTS
- 14 External Trigger
- 15 External Illumination

Note: Use of a cable with improper pin assignments may lead to damage to the unit. Use of any cables not provided by the manufacturer may result in damage not covered by your warranty.

USB

15 Pin D-type

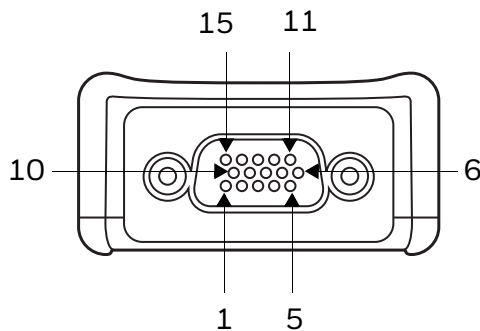

- 1 Reserved
- 2 Reserved
- 3 Reserved
- 4 USB D-
- 5 USB D+
- 6 Ground
- 7 Reserved
- 8 Reserved
- 9 Reserved
- 10 Host Power (+5V)
- 11 Jump to Pin 10
- 12 Reserved
- 13 Reserved
- 14 External Trigger
- 15 External Illumination

Note: Use of a cable with improper pin assignments may lead to damage to the unit. Use of any cables not provided by the manufacturer may result in damage not covered by your warranty.

Required Safety Labels

Scanner

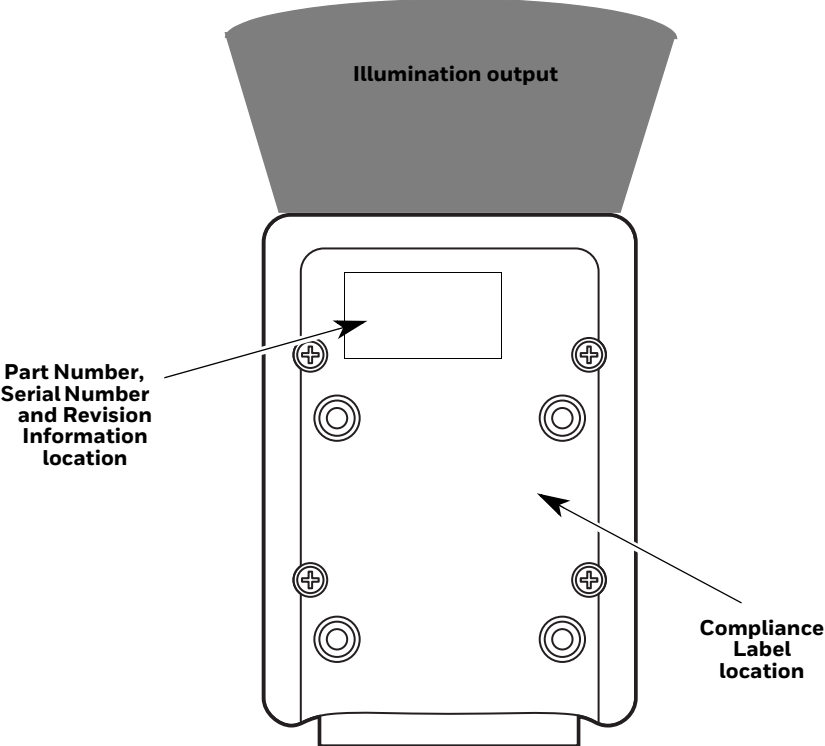

MAINTENANCE AND TROUBLESHOOTING

Repairs

Repairs and/or upgrades are not to be performed on this product. These services are to be performed only by an authorized service center (see [Customer Support](#) on page xiii).

Maintenance

Your device provides reliable and efficient operation with a minimum of care. Although specific maintenance is not required, the following periodic checks ensure dependable operation:

Cleaning the Scanner

The scanner's housing may be cleaned with a soft cloth or tissue dampened with water (or a mild detergent-water solution.) If a detergent solution is used, rinse with a clean tissue dampened with water only.



Caution: Do not submerge the scanner in water. The scanner's housing is not watertight. Do not use abrasive wipes or tissues on the scanner's window. Abrasive wipes may scratch the window. Never use solvents (e.g., acetone) on the housing or window. Solvents may damage the finish or the window.

Cleaning the Window

Reading performance may degrade if the scanner's window is not clean. If the window is visibly dirty, or if the scanner isn't operating well, clean the window with one of the cleaning solutions listed below.

- Sani-Cloth[®] HB wipes
- Sani-Cloth[®] Plus wipes

- Super Sani-Cloth[®] wipes
- Isopropyl Alcohol wipes (70%)
- CaviWipes[™]
- Virex[®] 256
- 409[®] Glass and Surface Cleaner
- Windex[®] Blue
- Clorox[®] Bleach – 10%
- Gentle dish soap and water

Inspecting Cords and Connectors

Inspect the interface cable and connector for wear or other signs of damage. A badly worn cable or damaged connector may interfere with scanner operation. Contact your distributor for information about cable replacement. Cable replacement instructions are on [page 208](#).

Replacing Cables

The standard interface cable is attached to the scanner with an 15-pin modular connector. The interface cable is designed to be field replaceable.

- Order replacement cables from Honeywell or from an authorized distributor.
- When ordering a replacement cable, specify the cable part number of the original interface cable.

Replacing an Interface Cable

1. Turn the power to the host system OFF.
2. Disconnect the scanner's cable from the terminal or computer.
3. Rotate the two screws counter clockwise to loosen the screws.
4. Gently pull the connector.
5. Replace with the new cable.
Insert the connector into the socket on the 3320.
Rotate the two screws clockwise to tighten.

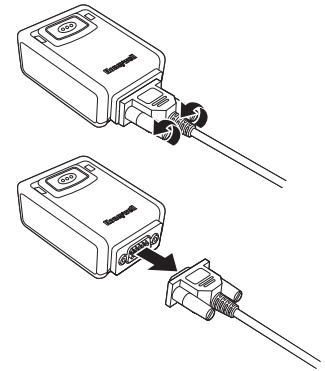

Troubleshooting a Corded Scanner

The scanner automatically performs self-tests whenever you turn it On. If your scanner is not functioning properly, review the following Troubleshooting Guide to try to isolate the problem.

Is the power On? Is the aimer On?

If the aimer isn't illuminated, check that:

- The cable is connected properly.
- The host system power is On (if external power isn't used).
- The button works.

Is the scanner having trouble reading your symbols?

If the scanner isn't reading symbols well, check that the symbols:

- Aren't smeared, rough, scratched, or exhibiting voids.
- Aren't coated with frost or water droplets on the surface.
- Are enabled in the scanner or in the decoder to which the scanner connects.

Is the barcode displayed but not entered?

The barcode is displayed on the host device correctly, but you still have to press a key to enter it (the Enter/Return key or the Tab key, for example).

- You need to program a suffix. Programming a suffix enables the scanner to output the barcode data plus the key you need (such as "CR") to enter the data into your application. Refer to [Prefix/Suffix Overview](#) on page 61 for further information.

The scanner won't read your barcode at all.

1. Scan the sample barcodes in the [Programming Chart](#), beginning on page 222. If the scanner reads the sample barcodes, check that your barcode is readable. Verify that your barcode symbology is enabled (see [Chapter 7](#)).
2. If the scanner still can't read the sample barcodes, scan [All Symbologies On](#) on page 94.

If you aren't sure what programming options have been set in the scanner, or if you want the factory default settings restored, refer to [Activate Custom Defaults](#) on page 6.

Symbology Charts

Note: “m” represents the AIM modifier character. Refer to *International Technical Specification, Symbology Identifiers*, for AIM modifier character details.

Prefix/Suffix entries for specific symbologies override the universal (All Symbologies, 99) entry.

Refer to [Data Editing](#) on page 61 and [Data Formatting](#) on page 67 for information about using Code ID and AIM ID.

Linear Symbologies

Symbology	AIM		Honeywell	
	ID	Possible modifiers (m)	ID	Hex
All Symbologies				99
Codabar	JFm	0-1	a	61
Code 11	JH3		h	68
Code 128	JCm	0, 1, 2, 4	j	6A
Code 32 Pharmaceutical (PARAF)	JX0		<	3C
Code 39 (supports Full ASCII mode)	JAm	0, 1, 3, 4, 5, 7	b	62
TCIF Linked Code 39 (TLC39)	JL2		T	54
Code 93 and 93i	JGm	0-9, A-Z, a-m	i	69
EAN	JEm	0, 1, 3, 4	d	64
EAN-13 (including Bookland EAN)	JE0		d	64
EAN-13 with Add-On	JE3		d	64
EAN-13 with Extended Coupon Code	JE3		d	64
EAN-8	JE4		D	44
EAN-8 with Add-On	JE3		D	44

Symbology	AIM		Honeywell	
	ID	Possible modifiers (m)	ID	Hex
GS1				
GS1 DataBar	jem	0	y	79
GS1 DataBar Limited	jem		{	7B
GS1 DataBar Expanded	jem		}	7D
GS1-128	IC1		l	49
2 of 5				
China Post (Hong Kong 2 of 5)	IX0		Q	51
Interleaved 2 of 5	lIm	0, 1, 3	e	65
Matrix 2 of 5	IX0		m	6D
NEC 2 of 5	IX0		Y	59
Straight 2 of 5 IATA	IRm	0, 1, 3	f	66
Straight 2 of 5 Industrial	ISO		f	66
MSI	IMm	0, 1	g	67
Telepen	IBm		t	74
UPC		0, 1, 2, 3, 8, 9, A, B, C		
UPC-A	IE0		c	63
UPC-A with Add-On	IE3		c	63
UPC-A with Extended Coupon Code	IE3		c	63
UPC-E	IE0		E	45
UPC-E with Add-On	IE3		E	45
UPC-E1	IX0		E	45

Add Honeywell Code ID				5C80
Add AIM Code ID				5C81
Add Backslash				5C5C
Batch mode quantity			5	35

2D Symbologies

Symbology	AIM		Honeywell	
	ID	Possible modifiers (m)	ID	Hex
<i>All Symbologies</i>				99
Aztec Code	izm	0-9, A-C	z	7A
Chinese Sensible Code (Han Xin Code)	IX0		H	48

Symbology	AIM		Honeywell	
	ID	Possible modifiers (m)	ID	Hex
Codablock A]O6	0, 1, 4, 5, 6	V	56
Codablock F]Om	0, 1, 4, 5, 6	q	71
Code 49]Tm	0, 1, 2, 4	l	6C
Data Matrix]dm	0-6	w	77
GS1]em	0-3	y	79
GS1 Composite]em	0-3	y	79
GS1 DataBar Omnidirectional]em	0-3	y	79
MaxiCode]Um	0-3	x	78
PDF417]Lm	0-2	r	72
MicroPDF417]Lm	0-5	R	52
QR Code]Qm	0-6	s	73
Micro QR Code]Qm		s	73

Postal Symbologies

Symbology	AIM		Honeywell	
	ID	Possible modifiers (m)	ID	Hex
<i>All Symbologies</i>				99
Australian Post]X0		A	41
British Post]X0		B	42
Canadian Post]X0		C	43
China Post]X0		Q	51
InfoMail]X0		,	2c
Intelligent Mail Barcode]X0		M	4D
Japanese Post]X0		J	4A
KIX (Netherlands) Post]X0		K	4B
Korea Post]X0		?	3F
Planet Code]X0		L	4C
Postal-4i]X0		N	4E
Postnet]X0		P	50

ASCII Conversion Chart (Code Page 1252)

In keyboard applications, ASCII Control Characters can be represented in 3 different ways, as shown below. The CTRL+X function is OS and application dependent. The following table lists some commonly used Microsoft functionality. This table applies to U.S. style keyboards. Certain characters may differ depending on your Country Code/PC regional settings.

Non-printable ASCII control characters			Keyboard Control + ASCII (CTRL+X) Mode		
DEC	HEX	Char	Control + X Mode Off (KBDCAS0)	Windows Mode Control + X Mode On (KBDCAS2)	
				CTRL + X	CTRL + X function
0	00	NUL	Reserved	CTRL+ @	
1	01	SOH	NP Enter	CTRL+ A	Select all
2	02	STX	Caps Lock	CTRL+ B	Bold
3	03	ETX	ALT Make	CTRL+ C	Copy
4	04	EOT	ALT Break	CTRL+ D	Bookmark
5	05	ENQ	CTRL Make	CTRL+ E	Center
6	06	ACK	CTRL Break	CTRL+ F	Find
7	07	BEL	Enter / Ret	CTRL+ G	
8	08	BS	<i>(Apple Make)</i>	CTRL+ H	History
9	09	HT	Tab	CTRL+ I	Italic
10	0A	LF	<i>(Apple Break)</i>	CTRL+ J	Justify
11	0B	VT	Tab	CTRL+ K	hyperlink
12	0C	FF	Delete	CTRL+ L	list, left align
13	0D	CR	Enter / Ret	CTRL+ M	
14	0E	SO	Insert	CTRL+ N	New
15	0F	SI	ESC	CTRL+ O	Open
16	10	DLE	F11	CTRL+ P	Print
17	11	DC1	Home	CTRL+ Q	Quit
18	12	DC2	PrtScn	CTRL+ R	
19	13	DC3	Backspace	CTRL+ S	Save
20	14	DC4	Back Tab	CTRL+ T	
21	15	NAK	F12	CTRL+ U	
22	16	SYN	F1	CTRL+ V	Paste
23	17	ETB	F2	CTRL+ W	
24	18	CAN	F3	CTRL+ X	
25	19	EM	F4	CTRL+ Y	
26	1A	SUB	F5	CTRL+ Z	
27	1B	ESC	F6	CTRL+ [
28	1C	FS	F7	CTRL+ \	
29	1D	GS	F8	CTRL+]	
30	1E	RS	F9	CTRL+ ^	
31	1F	US	F10	CTRL+ -	
127	7F	␣	NP Enter		

Lower ASCII Reference Table

Note: Windows Code page 1252 and lower ASCII use the same characters.

Printable Characters								
DEC	HEX	Character	DEC	HEX	Character	DEC	HEX	Character
32	20	<SPACE>	64	40	@	96	60	`
33	21	!	65	41	A	97	61	a
34	22	"	66	42	B	98	62	b
35	23	#	67	43	C	99	63	c
36	24	\$	68	44	D	100	64	d
37	25	%	69	45	E	101	65	e
38	26	&	70	46	F	102	66	f
39	27	'	71	47	G	103	67	g
40	28	(72	48	H	104	68	h
41	29)	73	49	I	105	69	i
42	2A	*	74	4A	J	106	6A	j
43	2B	+	75	4B	K	107	6B	k
44	2C	,	76	4C	L	108	6C	l
45	2D	-	77	4D	M	109	6D	m
46	2E	.	78	4E	N	110	6E	n
47	2F	/	79	4F	O	111	6F	o
48	30	0	80	50	P	112	70	p
49	31	1	81	51	Q	113	71	q
50	32	2	82	52	R	114	72	r
51	33	3	83	53	S	115	73	s
52	34	4	84	54	T	116	74	t
53	35	5	85	55	U	117	75	u
54	36	6	86	56	V	118	76	v
55	37	7	87	57	W	119	77	w
56	38	8	88	58	X	120	78	x
57	39	9	89	59	Y	121	79	y
58	3A	:	90	5A	Z	122	7A	z
59	3B	;	91	5B	[123	7B	{
60	3C	<	92	5C	\	124	7C	
61	3D	=	93	5D]	125	7D	}
62	3E	>	94	5E	^	126	7E	~
63	3F	?	95	5F	_	127	7F	△

Extended ASCII Characters					
DEC	HEX	CP 1252	ASCII	Alternate Extended	PS2 Scan Code
128	80	€	Ç	up arrow ↑	0x48
129	81		ü	down arrow ↓	0x50
130	82	,	é	right arrow →	0x4B
131	83	f	â	left arrow ←	0x4D
132	84	„	ä	Insert	0x52
133	85	…	à	Delete	0x53
134	86	†	â	Home	0x47
135	87	‡	ç	End	0x4F
136	88	^	ê	Page Up	0x49
137	89	‰	ë	Page Down	0x51

Extended ASCII Characters (Continued)

DEC	HEX	CP 1252	ASCII	Alternate Extended	PS2 Scan Code
138	8A	Š	è	Right ALT	0x38
139	8B	‹	ï	Right CTRL	0x1D
140	8C	Œ	î	Reserved	n/a
141	8D		ì	Reserved	n/a
142	8E	Ž	Ä	Numeric Keypad Enter	0x1C
143	8F		Å	Numeric Keypad /	0x35
144	90		É	F1	0x3B
145	91	‘	æ	F2	0x3C
146	92	’	Æ	F3	0x3D
147	93	“	ô	F4	0x3E
148	94	”	ö	F5	0x3F
149	95	•	ò	F6	0x40
150	96	–	û	F7	0x41
151	97	—	ù	F8	0x42
152	98	˜	ÿ	F9	0x43
153	99	™	Ö	F10	0x44
154	9A	š	Ü	F11	0x57
155	9B	›	ø	F12	0x58
156	9C	œ	£	Numeric Keypad +	0x4E
157	9D		¥	Numeric Keypad -	0x4A
158	9E	ž	Pts	Numeric Keypad *	0x37
159	9F	ÿ	f	Caps Lock	0x3A
160	A0		á	Num Lock	0x45
161	A1	ı	í	Left Alt	0x38
162	A2	ø	ó	Left Ctrl	0x1D
163	A3	£	ú	Left Shift	0x2A
164	A4	¤	ñ	Right Shift	0x36
165	A5	¥	Ñ	Print Screen	n/a
166	A6	ı	ª	Tab	0x0F
167	A7	§	º	Shift Tab	0x8F
168	A8	¨	¿	Enter	0x1C
169	A9	©	ƒ	Esc	0x01
170	AA	ª	¬	Alt Make	0x36
171	AB	«	½	Alt Break	0xB6
172	AC	¬	¼	Control Make	0x1D
173	AD		ı	Control Break	0x9D
174	AE	®	«	Alt Sequence with 1 Character	0x36
175	AF	¯	»	Ctrl Sequence with 1 Character	0x1D
176	B0	°	⌘		
177	B1	±	⌘		
178	B2	²	⌘		
179	B3	³	⌘		
180	B4	´	⌘		
181	B5	µ	⌘		
182	B6	¶	⌘		
183	B7	·	⌘		
184	B8	¸	⌘		
185	B9	¹	⌘		
186	BA	º	⌘		
187	BB	»	⌘		
188	BC	¼	⌘		
189	BD	½	⌘		
190	BE	¾	⌘		

Extended ASCII Characters (Continued)					
DEC	HEX	CP 1252	ASCII	Alternate Extended	PS2 Scan Code
191	BF	ı	⌗		
192	C0	À	⌘		
193	C1	Á	⌙		
194	C2	Â	⌚		
195	C3	Ã	⌛		
196	C4	Ä	⌜		
197	C5	Å	⌝		
198	C6	Æ	⌞		
199	C7	Ç	⌟		
200	C8	È	⌠		
201	C9	É	⌡		
202	CA	Ê	⌢		
203	CB	Ë	⌣		
204	CC	Ì	⌤		
205	CD	Í	⌥		
206	CE	Î	⌦		
207	CF	Ï	⌧		
208	D0	Ð	⌨		
209	D1	Ñ	〈		
210	D2	Ò	〉		
211	D3	Ó	⌫		
212	D4	Ô	⌬		
213	D5	Õ	⌭		
214	D6	Ö	⌮		
215	D7	×	⌯		
216	D8	Ø	⌰		
217	D9	Ù	⌱		
218	DA	Ú	⌲		
219	DB	Û	■		
220	DC	Ü	■		
221	DD	Ý	■		
222	DE	Þ	■		
223	DF	ß	■		
224	E0	à	α		
225	E1	á	β		
226	E2	â	Γ		
227	E3	ã	π		
228	E4	ä	Σ		
229	E5	å	σ		
230	E6	æ	μ		
231	E7	ç	τ		
232	E8	è	Φ		
233	E9	é	Θ		
234	EA	ê	Ω		
235	EB	ë	δ		
236	EC	ì	∞		
237	ED	í	φ		
238	EE	î	ε		
239	EF	ï	∩		
240	F0	ð	≡		
241	F1	ñ	±		
242	F2	ò	≥		
243	F3	ó	≤		

Extended ASCII Characters (Continued)					
DEC	HEX	CP 1252	ASCII	Alternate Extended	PS2 Scan Code
244	F4	ô			
245	F5	õ]		
246	F6	ö	+		
247	F7	÷	≈		
248	F8	ø	°		
249	F9	ù	·		
250	FA	ú	·		
251	FB	û	√		
252	FC	ü	ñ		
253	FD	ý	²		
254	FE	þ	■		
255	FF	ÿ			

ISO 2022/ISO 646 Character Replacements

Code pages define the mapping of character codes to characters. If the data received does not display with the proper characters, it may be because the barcode being scanned was created using a code page that is different from the one the host program is expecting. If this is the case, select the code page with which the barcodes were created. The data characters should then appear properly.

Code Page Selection Method/ Country	Standard	Keyboard Country	Honeywell Code Page Option
United States (standard ASCII)	ISO/IEC 646-IRV	n/a	1
Automatic National Character Replacement	ISO/IEC 2022	n/a	2 (default)
Binary Code page	n/a	n/a	3
Default "Automatic National Character replacement" will select the below Honeywell Code Page options for Code128, Code 39 and Code 93.			
United States	ISO/IEC 646-06	0	1
Canada	ISO /IEC 646-121	54	95
Canada	ISO /IEC 646-122	18	96
Japan	ISO/IEC 646-14	28	98
China	ISO/IEC 646-57	92	99
Great Britain (UK)	ISO /IEC 646-04	7	87
France	ISO /IEC 646-69	3	83
Germany	ISO/IEC646-21	4	84
Switzerland	ISO /IEC 646-CH	6	86
Sweden / Finland (extended Annex C)	ISO/IEC 646-11	2	82
Ireland	ISO /IEC 646-207	73	97

Code Page Selection Method/ Country	Standard	Keyboard Country	Honeywell Code Page Option
Denmark	ISO/IEC 646-08	8	88
Norway	ISO/IEC 646-60	9	94
Italy	ISO/IEC 646-15	5	85
Portugal	ISO/IEC 646-16	13	92
Spain	ISO/IEC 646-17	10	90
Spain	ISO/IEC 646-85	51	91

Dec			35	36	64	91	92	93	94	96	123	124	125	126
Hex			23	24	40	5B	5C	5D	5E	60	7B	7C	7D	7E
US	0	1	#	\$	@	[\]	^	`	{		}	~
CA	54	95	#	\$	à	â	ç	ê	î	ô	é	ù	è	û
CA	18	96	#	\$	à	â	ç	ê	É	ô	é	ù	è	û
JP	28	98	#	\$	@	[¥]	^	`	{		}	-
CN	92	99	#	¥	@	[\]	^	`	{		}	-
GB	7	87	£	\$	@	[\]	^	`	{		}	~
FR	3	83	£	\$	à	°	ç	§	^	μ	é	ù	è	..
DE	4	84	#	\$	§	Ä	Ö	Ü	^	`	ä	ö	ü	ß
CH	6	86	ù	\$	à	é	ç	ê	î	ô	ä	ö	ü	û
SE/FI	2	82	#	¤	É	Ä	Ö	Å	Ü	é	ä	ö	å	ü
DK	8	88	#	\$	@	Æ	Ø	Å	^	`	æ	ø	å	~
NO	9	94	#	\$	@	Æ	Ø	Å	^	`	æ	ø	å	-
IE	73	97	£	\$	Ó	É	Í	Ú	Á	ó	é	í	ú	á
IT	5	85	£	\$	§	°	ç	é	^	ù	à	ò	è	ì
PT	13	92	#	\$	§	Ã	Ç	Õ	^	`	ã	ç	õ	°
ES	10	90	#	\$	§	í	Ñ	¿	^	`	°	ñ	ç	~
ES	51	91	#	\$	·	í	Ñ	Ç	¿	`	´	ñ	ç	..
COUNTRY	Country Keyboard	Honeywell Code Page	ISO / IEC 646 National Character Replacements											

Sample Symbols

Code 93



Straight 2 of 5 Industrial



Matrix 2 of 5



RSS-14



PDF417



Code 49



Postnet



Data Matrix



QR Code



Test Symbol

MaxiCode

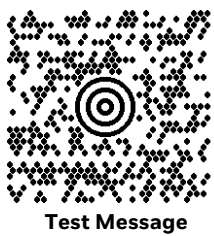

Micro PDF417



Programming Chart



K0K
0



K2K
2



K4K
4



K6K
6



K8K
8



K1K
1



K3K
3



K5K
5



K7K
7



K9K
9

Programming Chart



KAK
A



KCK
C



KEK
E



MNUSAV.
Save



RESET_
Reset



KBK
B



KDK
D



KFK
F



MNUABT.
Discard

Note: If you make an error while scanning the letters or digits (before scanning **Save**), scan **Discard**, scan the correct letters or digits, and **Save** again.

Honeywell
855 S. Mint Street
Charlotte, NC 28202

sps.honeywell.com