



**HV Inline valve, DN 16 ISO-KF,
manual, SS/FKM, "A"-dim.102
mm**



HV Inline valve, DN 16 ISO-KF, manual, SS/FKM, "A"-dim.102 mm

- With elastomer seals for high vacuum operation
- Stainless steel body with welded diaphragm bellows
- Conductance continuously variable with handwheel (multi-turn)
- Fully retracting and opening
- Additional O-ring materials available

Dimensions

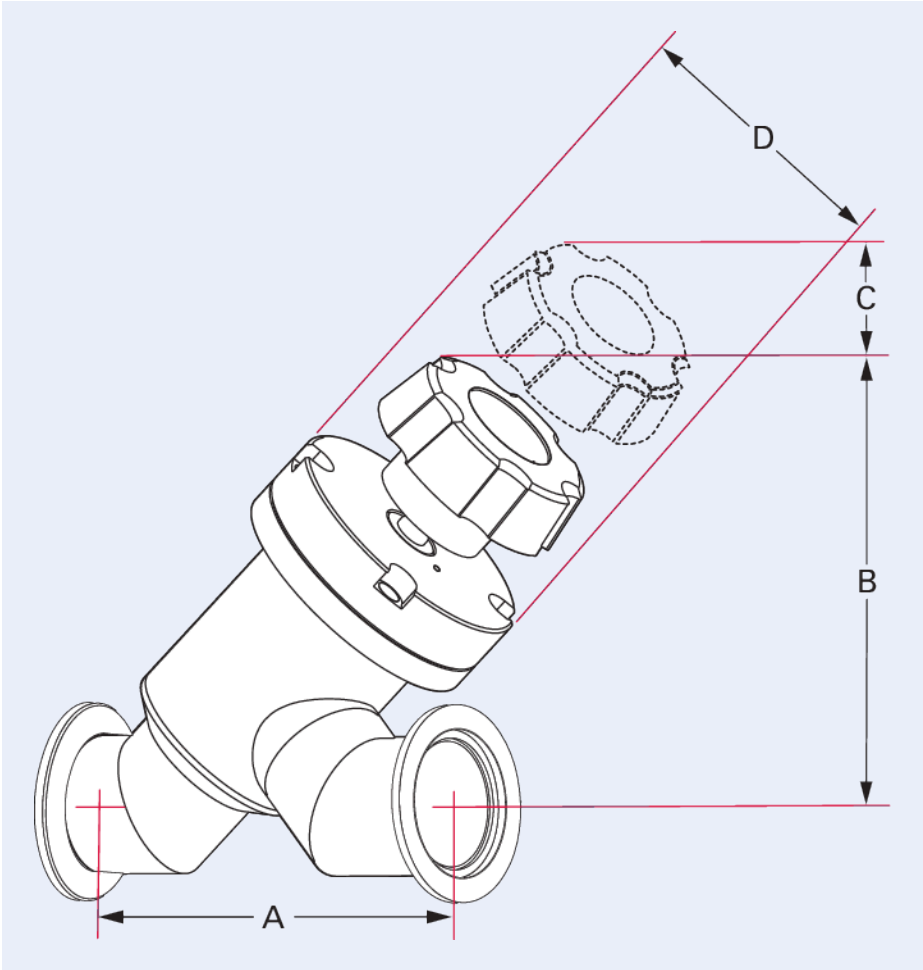

A	102 mm
B	88 mm
C	14 mm
D	57 mm

Technical Data	HV Inline valve, DN 16 ISO-KF, manual, SS/FKM, "A"-dim.102 mm
Feedthrough	Bellows Stainless steel
Seal	FKM
Type	HV Inline Valve
Housing	Stainless steel
Actuator	Spindle Handwheel
Tightness	$1 \cdot 10^{-11}$ Pa m ³ /s $1.33 \cdot 10^{-9}$ Torr l/s $1 \cdot 10^{-9}$ mbar l/s
Bakeout temperature: actuator	60 °C 140 K -213.15 °F
Conductance value with molecular flow	4 l/s
Operating pressure min.	$1 \cdot 10^{-8}$ hPa $7.5 \cdot 10^{-9}$ Torr $1 \cdot 10^{-8}$ mbar
Pressure max. (absolute)	1,000 hPa 750 Torr 1,000 mbar
Bakeout temperature: housing	150 °C 302 K -123.2 °F
Differential pressure in closing direction	1,400 hPa 1,050 Torr 1,400 mbar
Differential pressure in opening direction	1,400 hPa 1,050 Torr 1,400 mbar
Weight	1 kg 2.2 lb
Connection flange	DN 16 ISO-KF

Order number	HV Inline valve, DN 16 ISO-KF, manual, SS/FKM, "A"-dim.102 mm
HV Inline valve, DN 16 ISO-KF, manual, SS/FKM, "A"-dim.102 mm	AIV-S02100

Your Success. Our Passion.

We give our best for you every day –
worldwide!

Are you looking for an optimum vacuum solution?

Talk to us:
Pfeiffer Vacuum GmbH
Germany
T +49 6441 802-0

Or scan the barcode, to visit our web page:



<https://webportal.pfeiffer-vacuum.com/global/en/contact>



Errors and/or changes excepted. - 7/5/2024

Follow Us On Social Media
#pfeiffervacuum



PFEIFFER  **VACUUM**

www.pfeiffer-vacuum.com